

Manitowoc 16000

Operator Manual

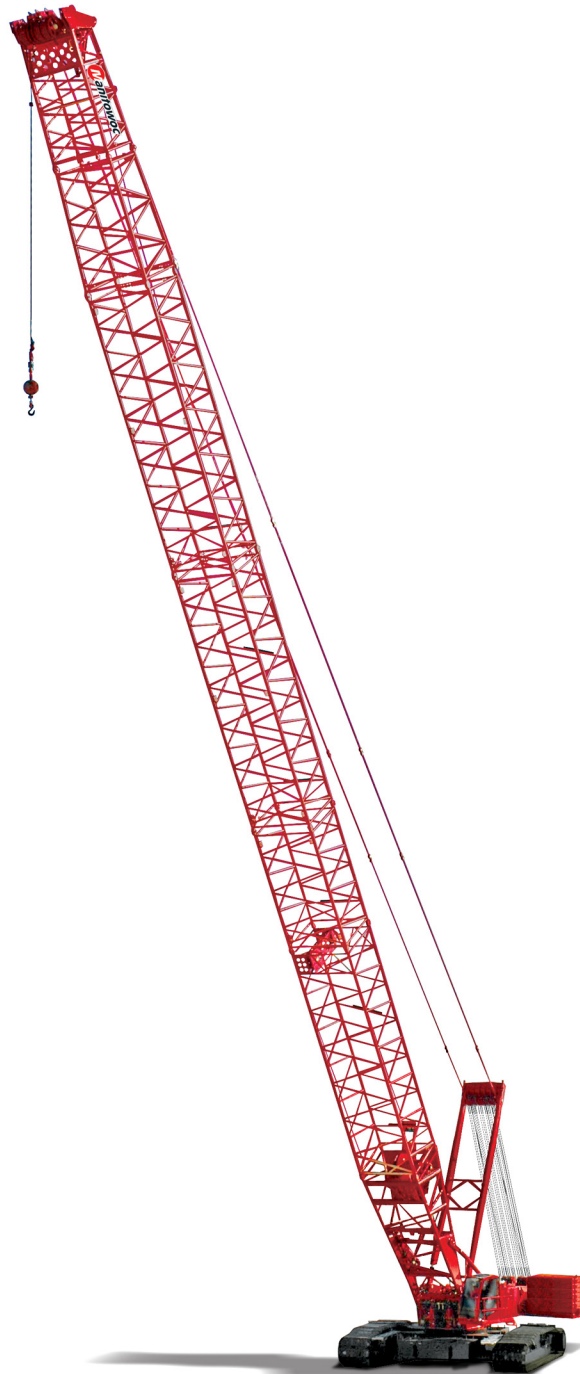



OPERATOR MANUAL

This manual has been prepared for and is considered part of -

16000

Crane Model Number

16001Ref

Crane Serial Number

This Manual is divided into the following sections:

SECTION 1	INTRODUCTION
SECTION 2	SAFETY INFORMATION
SECTION 3	OPERATING CONTROLS AND PROCEDURES
SECTION 4	SET-UP AND INSTALLATION
SECTION 5	LUBRICATION
SECTION 6	MAINTENANCE CHECKLIST

NOTICE

The serial number of the crane and applicable attachments (i.e. luffing jib, MAX-ER[®]) is the only method your Manitowoc dealer or the Manitowoc Crane Care Lattice Team has of providing you with correct parts and service information.

The serial number is located on a crane identification plate attached to the operator's cab and each attachment. Refer to the Nameplate and Decal Assembly Drawing in Section 2 of this manual for the exact location of the crane identification plate.

Always furnish serial number of crane and its attachments when ordering parts or discussing service problems with your Manitowoc dealer or the Manitowoc Crane Care Lattice Team.

	⚠ WARNING
	<p>To prevent death or serious injury:</p> <ul style="list-style-type: none">• Avoid unsafe operation and maintenance. Crane and attachments must be operated and maintained by trained and experienced personnel. Manitowoc is not responsible for qualifying these personnel.• Do not operate or work on crane or attachments without first reading and understanding instructions contained in Operator Information Manual and Service Manual supplied with crane and applicable attachments.• Store Operator Information Manual and Service Manual in operator's cab. <p>If Operator Information Manual or Service Manual is missing from cab, contact your Manitowoc dealer for a new one.</p>



THE ORIGINAL LANGUAGE OF THIS PUBLICATION IS ENGLISH

See end of this manual for Alphabetical Index

SECTION 1	Introduction
Crane Data	1-1
Crane/Attachment Identification	1-1
Change of Ownership Registration	1-1
Manitowoc Dealer	1-1
Crane Orientation	1-1
Identification and Location of Components	1-2
English and Metric Conversions	1-4
Direct Conversion	1-4
Inverse Conversion	1-4
SECTION 2	Safety Information
Continuous Innovation	2-1
Nameplates and Decals	2-1
Safety Messages	2-1
General	2-1
Safety Alert Symbol	2-1
Signal Words	2-1
Symbol Identification	2-1
Safety and Information Signs	2-3
Maintaining Signs	2-3
Ordering Signs	2-3
Crane Access Points	2-5
General	2-5
Getting On or Off Crane	2-5
Operator Manual/Capacity Chart Storage	2-6
General	2-6
Storing Manuals	2-6
Deploying Swing Radius Barrier	2-7
Storing Swing Radius Barrier	2-7
Safe Operating Practices	2-8
General	2-8
Read Operator Manual	2-8
Operator Qualifications	2-8
Operator Conduct	2-8
Handling Load	2-10
Signals	2-13
Safety Devices	2-14
Operational Aids	2-14
Category 1 Operational Aids	2-14
Category 2 Operational Aids	2-15
Assembling, Disassembling, or Operating Crane Near Electric Power and Transmission Lines	2-16
Electrocution Hazard	2-16
Set-Up and Operation	2-16
Electrocution Hazard Devices	2-17
Electrical Contact	2-17
Refueling	2-18
Fire Extinguishers	2-18
Accidents	2-18
Safe Maintenance	2-18
Maintenance Instructions	2-18
Safe Maintenance Practices	2-18
Environmental Protection	2-20
Boom Disassembly Safety	2-23
General	2-23

Location	2-23
Pin Removal	2-23
Disassembly Precaution	2-23
Personnel Handling Policy	2-24
Pedestal/barge Mounted Cranes	2-26
Pedestal Mounted Crane	2-26
Barge Mounted Crane	2-26
Capacity Charts	2-28
Shock Loading	2-28
Operation On Barge	2-28
Crane Inspection	2-29
Transporting Crane on Barge	2-29

SECTION 3 **Operating Controls And Procedures**

Standard Hand Signals for Controlling Crane Operations	3-2
Symbol Identification	3-4
Front Window Operation	3-10
Closing Window	3-10
Opening Window For Ventilation	3-10
Opening Window For Emergency Exit	3-10
Operating Controls	3-10
General	3-10
Cab Door Damper Adjustment	3-11
Closing Cab Door	3-11
Damper Adjustment	3-11
Controls Identification And Function	3-13
A – Engine Controls	3-13
B – Accessory Controls	3-14
C – Indicators	3-17
D – Special Controls	3-19
Luffing Jib Setup Mode	3-23
E – Boom/Mast Hoist Controls	3-25
F – Load Drum Controls	3-25
G – Swing Controls	3-26
H – Travel Controls	3-27
J – Winch Controls	3-27
Limit Devices	3-28
Boom Up Limit	3-28
Block-Up Limit	3-28
Luffing Jib Up Limit	3-28
Luffing Jib Down Limit	3-29
Minimum Bail Limit	3-29
MAX-ER® Mast Stop Retracted	3-29
Seat Controls	3-30
Preparing Crane for Operation	3-31
Operation	3-32
Engine Startup	3-32
Boom/Mast Hoist Operation	3-34
Luffing Hoist Operation	3-35
Swing Operation	3-36
Load Drum Operation	3-37
Travel Operation	3-38
Stopping Engine/ Leaving Crane Unattended	3-40
Remote Controls	3-41
General	3-41
Remote Control Priority	3-41

Wireless Remote Controls	3-42
Wired Remote Controls	3-43
Crane Setup Remote Control Activation	3-44
Crane Setup Remote Controls Operation	3-45
Carbody Remote Controls Operation	3-47
Wireless Remote Battery Replacement	3-47
Displays	3-48
Display Controls	3-48
Display Brightness and Color Contrast	3-48
Restore Factory Default Display Settings	3-48
Blank Display	3-48
Main GUI Display Format	3-49
Screen Prompts	3-49
Menu Screen	3-49
Information Screen	3-50
Diagnostic Screen	3-53
Function Mode Screens	3-59
CAN Bus Screen	3-62
Digital Output Reference Chart	3-65
Digital Input Reference Chart	3-66
Camera Screen (Optional)	3-69
Pressure Test and Calibration Screen	3-69
Wind Conditions	3-73
Preparation for Cold Weather	3-75
Crane Limitations	3-75
Wire Rope	3-75
Cold Weather Starting Aid	3-75
Cooling System	3-75
Battery	3-75
Engine Oil	3-75
Fuel Oil	3-75
Gear Oil	3-75
Hydraulic Oil	3-76
Cold Weather Heater Package	3-76
General	3-76
Heaters	3-76
Turning Heaters On	3-76
Turning Heaters Off	3-76
Circuit Breakers	3-77
Past Production Cold Weather Package	3-78
Current Production Cold Weather Package	3-79

SECTION 4. Set-Up and Installation

Rigging Drawings	4-1
Liftcrane Mast Capacities	4-1
Optional Attachments	4-1
General Safety	4-1
Crane Orientation	4-1
Self-Erecting Equipment	4-1
Assist Crane Requirements	4-2
Assembly and Disassembly Notes	4-2
Assembly And Disassembly Area	4-2
Accessing Parts	4-2
Crane Weights	4-2
Handling Components	4-3
Retaining Connecting Pins	4-3

Pin and Connecting Hole Cleanliness	4-3
Hose and Cable Cleanliness	4-3
Cold Weather Mast Operation	4-3
Shipping Crane Components	4-6
Operating Controls	4-6
Pre-Start Checks	4-7
Engine	4-7
Gear Boxes	4-7
Hydraulic System	4-7
Starting Crane Engine	4-7
Crane Assembly	4-8
Install Exhaust Pipes (Past Production)	4-8
Remove Crane from Trailer	4-10
Raise Live Mast To Operating Position	4-13
Install Assembly Block	4-15
Handling Crawlers	4-17
Install Crawlers	4-19
Install Counterweight	4-23
Assemble Boom	4-29
Install Boom Butt	4-29
Remove Assembly Block	4-33
Connect Boom Butt to Boom	4-33
Node-6 Configuration with Mast Stop Limit Switch	4-36
Shipping Configuration (View A)	4-36
Working Configuration with Boom (View B)	4-37
Working Configuration with MAX-ER® (View C)	4-37
Crane Disassembly	4-37
Lower Boom	4-37
Disconnect Boom Butt from Boom	4-37
Install Assembly Block	4-38
Remove Boom Butt	4-38
Disassemble Boom	4-39
Remove Counterweight	4-39
Remove Crawler Stairways	4-40
Store Crawler Platforms	4-40
Remove Crawlers	4-40
Remove Assembly Block	4-41
Lower Live Mast To Shipping Position	4-42
Install Crane On Trailer	4-42
Remove Exhaust Pipes	4-42
Boom Ladder Assembly	4-45
General	4-45
Removing Ladders from Boom Butt	4-45
Installing Ladders on Boom Inserts	4-45
Storing Ladders in Boom Butt	4-45
Boom Rigging	4-46
Assist Crane Requirements	4-46
Blocked Crawler	4-46
Handling Components	4-46
Boom Assembly Drawing	4-46
Identifying Boom and Jib Components	4-47
Assemble Boom Sections	4-49
Connect Boom Straps	4-51
Install Intermediate Suspension	4-51
Install Standard Upper Boom Point	4-53
Install Extended Upper Boom Point	4-53
Install Load Line	4-58

Connect Boom Wiring 4-58

Perform Pre-Raising Checks 4-58

Boom Removal 4-58

Wire Rope Installation 4-62

 Wire Rope Storage 4-62

 Removing Wire Rope from Shipping Reel 4-62

 Seizing and Cutting Wire Rope 4-62

 Anchoring Wire Rope to Drum 4-63

 Drum Guards 4-63

 Winding Wire Rope onto Drum 4-65

 Anchoring Wire Rope to Wedge Socket 4-67

 Anchoring Wire Rope to Button Socket 4-67

 Breaking in Wire Rope 4-67

Drum Kicker Adjustment 4-68

 General 4-68

 Adjustment 4-68

Pad Eye Usage for Wire Rope Reeving 4-68

 General 4-68

 Safety 4-68

Rigging Winch Operation 4-70

 Selecting Rigging Winch Mode 4-70

 Operating Rigging Winch 4-70

Reeving – Load Block 4-72

 Load Block Identification 4-72

 Wire Rope Specifications 4-72

 Wire Rope Installation 4-72

 Duplex Hook 4-72

 Guide Sheaves and Drums 4-72

 Load Block Reeving 4-72

Reeving – Live Mast 4-79

 General 4-79

 Wire Rope Specification 4-79

SECTION 5. Lubrication

Lubrication 5-1

SECTION 6. Maintenance Checklist

Inspection and Maintenance Checklist 6-1

Fiberglass Maintenance 6-1

THIS PAGE INTENTIONALLY LEFT BLANK

Reference Only

SECTION 1 INTRODUCTION

TABLE OF CONTENTS

Crane Data	1-1
Crane/Attachment Identification	1-1
Change of Ownership Registration	1-1
Manitowoc Dealer	1-1
Crane Orientation	1-1
Identification and Location of Components	1-2
English and Metric Conversions	1-4
Direct Conversion	1-4
Inverse Conversion	1-4

Reference Only

THIS PAGE INTENTIONALLY LEFT BLANK

Reference Only

SECTION 1

INTRODUCTION

CRANE DATA

See end of this section for crane data specific to your crane:

- Basic Specifications
- EC Declaration (if applicable)

CRANE/ATTACHMENT IDENTIFICATION

An identification plate is attached to the outside of the operator's cab (see [Figure 1-1](#)) and to the attachments (for example, luffing jib and MAX-ER®).

The crane or attachment model and serial number are provided on the plate.

For the exact location of the identification labels on your crane and attachments, refer to the Nameplates and Decals Drawing in Section 2 of this manual.

CHANGE OF OWNERSHIP REGISTRATION

If you are the new owner of a Manitowoc crane, please register it with Manitowoc Crane Care so we can contact you if the need arises.

1. Go to www.manitowoccranes.com
2. Go to Service > Manitowoc Crane Care > Service Information > Change of Ownership Form.
3. Complete the form.

MANITOWOC DEALER

For questions about this manual or the 16000 crane, contact your Manitowoc dealer. If you do not know the contact information for your dealer, locate the Manitowoc dealer nearest you, as follows:

1. Go to www.manitowoccranes.com
2. Go to Dealer Locator.
3. Follow the on-screen prompts to locate your Manitowoc dealer.

CRANE ORIENTATION

The terms RIGHT, LEFT, FRONT, REAR used in this manual refer to operator's right, left, front, and rear sides when seated in the operator's cab looking forward.

- The boom is on the front of the rotating bed.
- The carbody and crawler controls are on the front of the carbody.

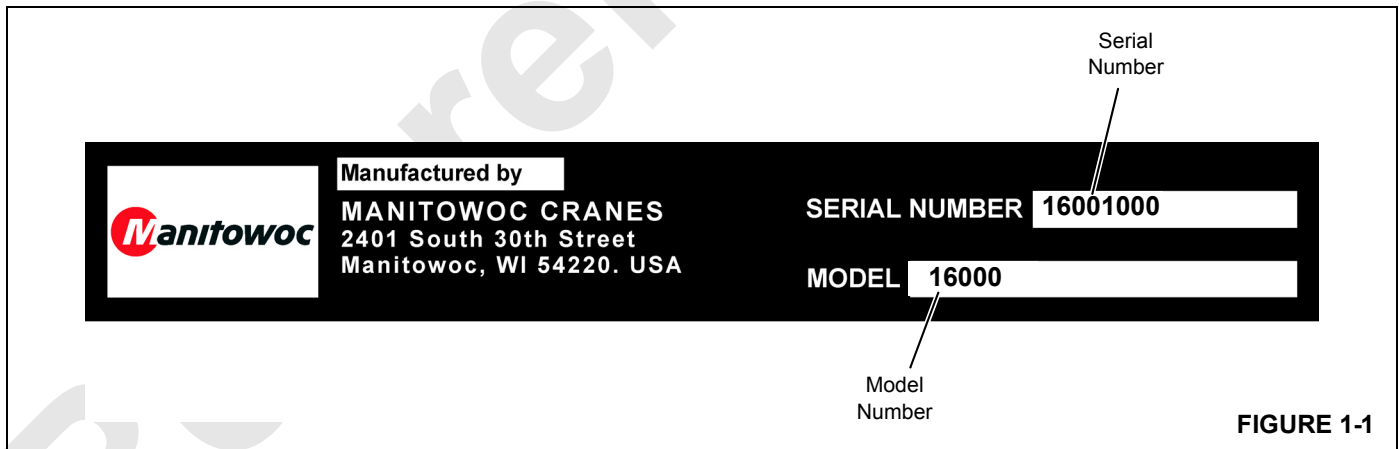
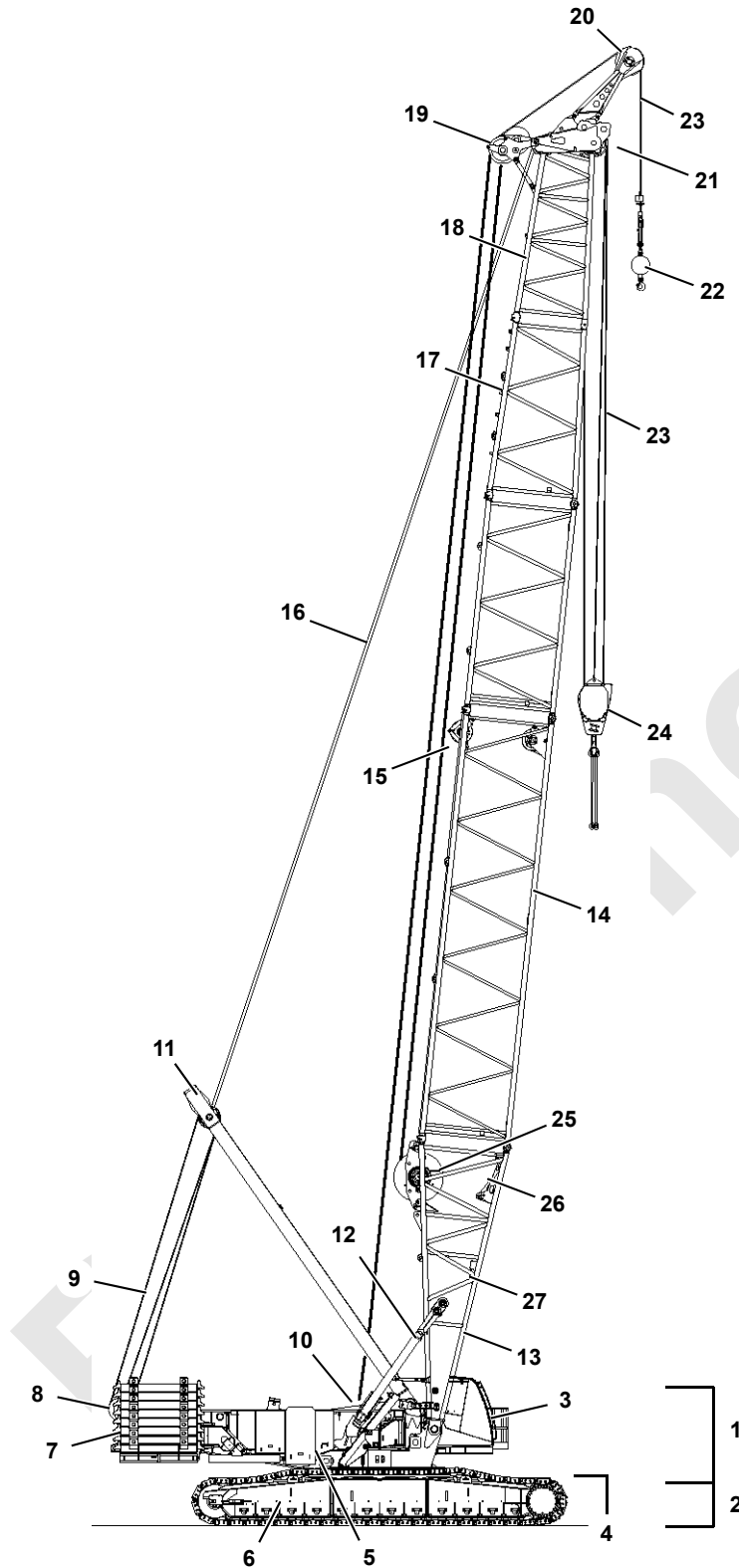

FIGURE 1-1

IDENTIFICATION AND LOCATION OF COMPONENTS



Item	Description
1	Upperworks
2	Undercarriage
3	Operator's Cab
4	Carbody Counterweight (both ends)
5	Enclosures (both sides)
6	Crawler
7	Crane Counterweight
8	Boom Hoist Sheaves
9	Boom Hoist Wire Rope
10	Mast Arms with Cylinders
11	Mast (Live)
12	Telescopic Boom Stop
13	Boom Butt
14	Boom Insert
15	Wire Rope Guides (in Insert)
16	Boom Straps
17	Transition Insert
18	Boom Top
19	Wire Rope Guide
20	Upper Boom Point
21	Lower Boom Point
22	Weight Ball
23	Load Lines
24	Load Block
25	Main Hoist
26	Auxiliary or Luffing Hoist
27	Rigging Winch
28	Swing Drive
29	Carbody Counterweights (both ends)
30	Platform with Step
31	Crawler Drive
32	Carbody
33	Adapter Frame (Rotating Bed)
34	Rotating Bed Jack (both sides front) (Not furnished with European option)
35	Rotating Bed
36	Rotating Bed Jack (both sides rear) (Not furnished with European option)
37	Boom Hoist (standard) OR Mast Hoist (MAX-ER®)
38	Fuel Tank
39	Radiator
40	Power Plant (with Pump Drive)
41	Hydraulic Tank
42	Whip Hoist
43	Carbody Jacks (European option)

A10740-3

FIGURE 1-2

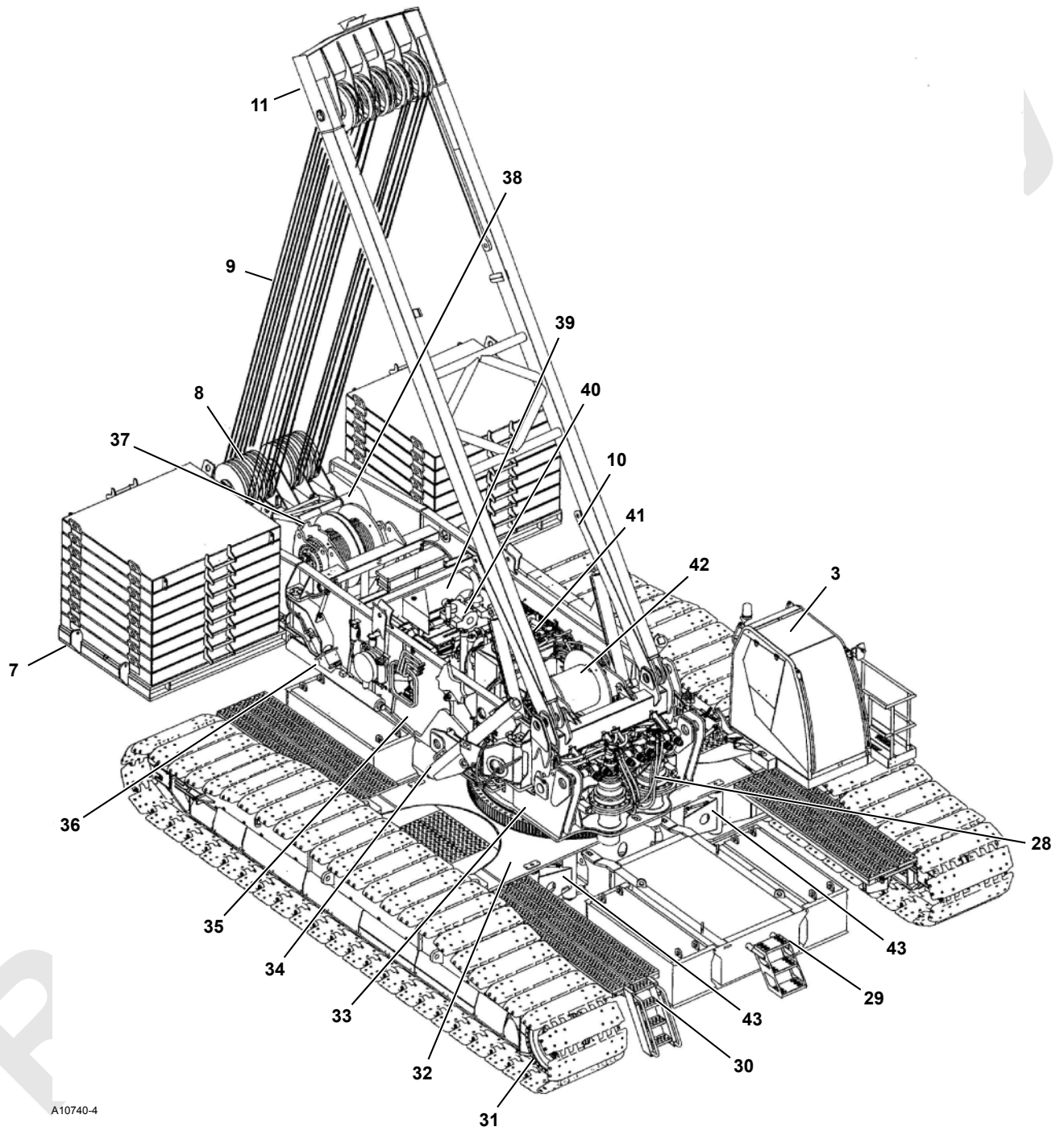

FIGURE 1-2 continued

ENGLISH AND METRIC CONVERSIONS

Direct Conversion

MULTIPLY (x) known value by conversion factor to obtain equivalent value in desired units. For example, 12 ft is converted to meters (m), as follows:

$$12 \text{ ft} \times 0.3048 = 3,6576 \text{ m}$$

Inverse Conversion

DIVIDE (÷) known value by conversion factor to obtain equivalent value in desired units. For example, 3,6576 m is converted to feet, as follows:

$$3,6576 \text{ m} \div 0.3048 = 12$$

To Convert	Symbol	Application	To	Symbol	Multiply By
AREA					
Square Inch	in ²	Filter Area Clutch Contact	Square Centimeter	cm ²	6.4516
Square Foot	ft ²	Ground Contact	Square Meter	m ²	0.0929
FORCE					
Pound Force	lb	Pedal Effort	KiloNewton Newton	kN N	0.00445 4.4482
Pound Force	lb	Line Pull	KiloNewton	kN	0.00445
Pound Force Per Inch	lb/in.	Spring Force	Newton per millimeter	Nmm	0.1751
Pound Force Per Foot	lb/ft		Newton per meter	Nm	14.5939
LENGTH					
Inch	in.	Adjustments	Millimeter	mm	25.4000
Foot	ft	Outline Dimensions	Meter	m	0.3048
Mile	miles	Travel Distance	Kilometer	km	1.6093
POWER					
Horsepower	hp	Engine	Kilowatt	kW	0.7457
PRESSURE					
Pound/Sq. In.	psi	Hydraulic & Air	Bar		0.0689
TEMPERATURE					
Degrees Fahrenheit	°F	Oil, Air, Etc.	Degrees Centigrade	°C	°F - 32 ÷ 1.8
Degrees Centigrade	°C		Degrees Fahrenheit	°F	°C x 1.8 + 32
TORQUE					
Inch Pound	in lb	Bolt Torque	Newton Meter	Nm	0.1129
Foot Pound	ft lb		Newton Meter	Nm	1.3558
VELOCITY					
Miles Per Hour	mph	Vehicle Speed	Kilometers Per Hour	km/h	1.6093
Miles Per Hour	mph	Wind Speed	Meters Per Second	m/s	0.4470
Feet Per Minute	fpm	Line Speed	Meters Per Minute	m/min	0.3048
VOLUME					
Cubic Yard	yd ³	Bucket Capacity	Cubic Meter	m ³	0.7646
Cubic Foot	ft ³		Cubic Meter	m ³	0.0283
Cubic Inch	in ³	Pump Displacement	Cubic Centimeter	cm ³	16.3871

To Convert	Symbol	Application	To	Symbol	Multiply By
VOLUME (LIQUID)					
Ounce	oz	Fluid Capacities	Milliliter	mL	29.5735
Pint	pt		Liter	L	0.4732
Quart	qt		Liter	L	0.9464
Gallon	gal		Liter	L	3.7854
Gallon Per Minute	gpm	Pump Flow	Liters Per Minute	L/min	3.7854
WEIGHT					
Pound	lb	Unit/Component	Kilogram	kg	0.4536
Ton (2,000 lb.)	USt	Load Ratings	Metric Ton	t	0.9072
Ton (2,000 lb.)	USt		Kilogram	kg	907.1847

THIS PAGE INTENTIONALLY LEFT BLANK

Reference Only

SECTION 2

SAFETY INFORMATION

TABLE OF CONTENTS

Continuous Innovation	2-1
Nameplates and Decals	2-1
Safety Messages	2-1
General	2-1
Safety Alert Symbol	2-1
Signal Words	2-1
Symbol Identification	2-1
Safety and Information Signs	2-3
Maintaining Signs	2-3
Ordering Signs	2-3
Crane Access Points	2-5
General	2-5
Getting On or Off Crane	2-5
Operator Manual/Capacity Chart Storage	2-6
General	2-6
Storing Manuals	2-6
Deploying Swing Radius Barrier	2-7
Storing Swing Radius Barrier	2-7
Safe Operating Practices	2-8
General	2-8
Read Operator Manual	2-8
Operator Qualifications	2-8
Operator Conduct	2-8
Handling Load	2-10
Size of Load	2-10
Attaching Load	2-10
Lifting/Moving Load	2-11
Multiple Load Line Operation	2-12
Holding Load	2-13
Signals	2-13
Safety Devices	2-14
Operational Aids	2-14
Category 1 Operational Aids	2-14
Category 2 Operational Aids	2-15
Assembling, Disassembling, or Operating Crane Near Electric Power and Transmission Lines	2-16
Electrocution Hazard	2-16
Set-Up and Operation	2-16
Electrocution Hazard Devices	2-17
Electrical Contact	2-17
Refueling	2-18
Fire Extinguishers	2-18
Accidents	2-18
Safe Maintenance	2-18
Maintenance Instructions	2-18
Safe Maintenance Practices	2-18
Environmental Protection	2-20
Boom Disassembly Safety	2-23
General	2-23
Location	2-23
Pin Removal	2-23
Disassembly Precaution	2-23

Personnel Handling Policy	2-24
Pedestal/barge Mounted Cranes	2-26
Pedestal Mounted Crane	2-26
Definition	2-26
Examples	2-26
Barge Mounted Crane	2-26
Definition	2-26
Examples	2-26
Capacity Charts	2-28
Shock Loading	2-28
Definition	2-28
Operation On Barge	2-28
General	2-28
Definitions	2-28
Crane Inspection	2-29
Transporting Crane on Barge	2-29

SECTION 2

SAFETY INFORMATION



WARNING

California Proposition 65

Breathing diesel engine exhaust exposes you to chemicals known to the State of California to cause cancer and birth defects or other reproductive harm.

- Always start and operate the engine in a well-ventilated area.
- If in an enclosed area, vent the exhaust to the outside.
- Do not modify or tamper with the exhaust system.
- Do not idle the engine except as necessary.

For more information go to www.P65warnings.ca.gov/diesel.

Battery posts, terminals, and related accessories contain chemical lead and lead compounds, chemicals known to the State of California to cause cancer, birth defects, and other reproductive harm. Wash hands after handling.

California Spark Arrestor

Operation of this equipment may create sparks that can start fires around dry vegetation. A spark arrestor may be required. The owner/operator should contact local fire agencies for laws or regulations relating to fire prevention requirements.

CONTINUOUS INNOVATION

Due to continuing product innovation, the information in this manual is subject to change without notice. If you are in doubt about any procedure, contact your Manitowoc dealer or the Manitowoc Crane Care Lattice Team.

NAMEPLATES AND DECALS

See drawing at the end of this section.

SAFETY MESSAGES

General

The importance of safe operation and maintenance cannot be over emphasized. Carelessness or neglect on the part of operators, job supervisors and planners, rigging personnel, and job site workers can result in their death or injury and costly damage to the crane and property.

To alert personnel to hazardous operating practices and maintenance procedures, safety messages are used throughout the manual. Each safety message contains a safety alert symbol and a signal word to identify the hazard's degree of seriousness.

Safety Alert Symbol



This is the safety alert symbol. It is used to alert you to potential personal injury hazards. **Obey all safety messages that follow this symbol to avoid possible death or injury.**

Signal Words



DANGER

Indicates a hazardous situation which, if not avoided, will result in death or serious injury.



WARNING

Indicates a hazardous situation which, if not avoided, could result in death or serious injury.



CAUTION

Used with the safety alert symbol, indicates a hazardous situation which, if not avoided, could result in minor or moderate injury.

CAUTION

Without the safety alert symbol, identifies potential hazards that could result in property damage.

NOTE: Highlights operation or maintenance procedures.

Symbol Identification

Many of the symbols used in the safety and information signs and nameplates on this crane are identified in [Table 2-1](#) and [Table 2-2](#).

Table 2-1 Common Safety Symbols















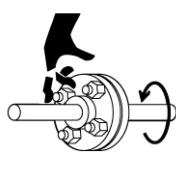

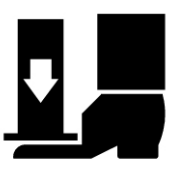











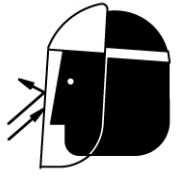





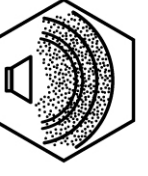

Cut or Crush Hazards					Cut Hazard
 M100090	 M100091	 M100066	 M100065	 M100069	 M100067
Crush Hazards					Fire Extinguisher
 M100070	 M100071	 M100072	 M100073	 M100074	 M100082
Fall Hazards			Falling Boom (Crush) Hazards		Explosion Hazard
 M100083	 M100084	 M100085	 M100068	 M100075	 M100080
Falling Load Hazards		Flying Objects Hazards		Overhead Obstruction Hazard	Pressure Release Hazard
 M100076	 M100077	 M100088	 M100088	 M100089	 M100081
Electrocution Hazards		Personal Fall Protection	Pressure Cleaning	Sound Power Level	Read Manual
 M100078	 M100079	 M100095	 M100087	 M100096	 M100093

Table 2-2 Miscellaneous Symbols

Diesel Fuel	Engine Coolant	Engine Coolant Vent	Engine Oil Level	Hydraulic Filter	Hydraulic Oil
 M100271	 M100267	 M100268	 M100269	 M100272	 M100273
Pump Drive Oil Level	Tire Pressure (if equipped)				
 M100270	 M100266				

SAFETY AND INFORMATION SIGNS

Maintaining Signs

The crane owner/user shall make sure that all safety and information signs are legible and installed at the proper locations on the crane. If a sign has been defaced or removed, it must be replaced immediately. See the Nameplate and Decal Drawing at the end of this section for the installation locations of signs.

Ordering Signs

Order replacement safety and information signs from your Manitowoc dealer.

When ordering a sign, give the crane model number, the crane serial number, and the name and part number of the sign.

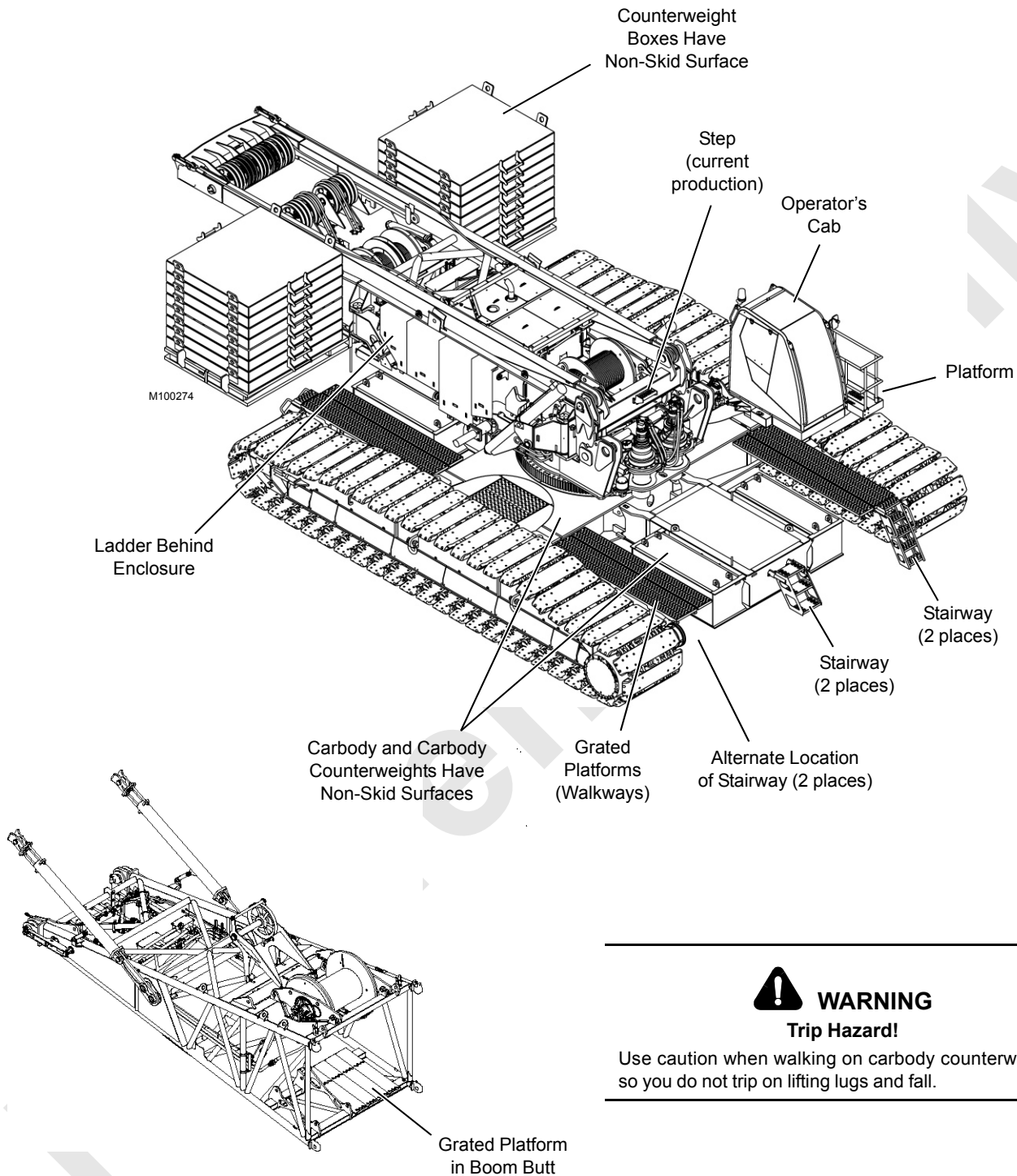

WARNING

Trip Hazard!

Use caution when walking on carbody counterweights so you do not trip on lifting lugs and fall.

FIGURE 2-1

CRANE ACCESS POINTS



WARNING

Crush Hazard!

Upperworks can swing into and crush personnel climbing on or off crane.

Moving crawlers can crush personnel climbing on or off crane.

To prevent death or serious injury:

- Barricade all accessible areas to crane so personnel cannot be struck or crushed when upperworks is swung. See Swing Radius Barrier topic in this section.
- Do not climb onto or off crane while upperworks is being swung or crane is being traveled.
- Signal operator for permission to climb onto/off crane.
- Operator: do not swing or travel while personnel are climbing onto or off crane. Stop swing and travel motions. Apply swing brake and turn on travel park.
- Operator: Always sound horn to alert personnel before you swing or travel.
- Automatic alarms will sound to alert personnel when the crane is swung or traveled.

NOTE: If the swing and travel alarms are not operating properly, they must be repaired as soon as possible. Until they are repaired, the operator must alert personnel to crane movement using the horn on the control console.

General

Take necessary precaution to prevent slipping and/or falling off the crane during assembly, disassembly, maintenance, or other work. **Falling from any height could result in serious injury or death.**

Manitowoc has provided stairways, ladders, and platforms at the locations shown in [Figure 2-1](#).

The owner/user must provide workers with approved ladders or aerial work platforms to access those areas of the crane, mast, and boom that cannot be reached from the ground or from steps, ladders, catwalks, and platforms provided by Manitowoc.

Adhere to local, state, and federal regulations for handling personnel and for personnel fall protection.

- Access points must be kept clear to prevent personal injury and unsafe operation of crane. Store clothing and

other personal belongings so they do not interfere with controls in operator's cab or with operation of crane.

- Do not allow ground personnel to store their personal belongings (clothing, lunch boxes, water coolers, and the like) on the crane.

This practice will prevent ground personnel from being crushed or electrocuted when they attempt to access personal belongings stored on the crane.

- Tools, oil cans, spare parts, and other necessary equipment must be stored in tool boxes or other appropriate locations. Do not allow these items to lie around loose in operators cab or on steps, ladders, catwalks, and platforms.
- To reduce risk of slipping, non-skid material (sand in paint) has been applied to painted walkways and platforms.

Walkways and platforms can be slippery when wet and when oil or is grease is spilled on them. **Keep walkways and platforms clean and dry to prevent slipping on them.** When non-skid material wears out, reapply it.

- Wear shoes with a highly slip-resistant sole material. Clean any mud or debris from shoes before entering the crane cab or climbing onto the cab. A shoe that is not clean might slip off a control pedal during operation.
- Do not make modifications or additions to the crane's access system that have not been evaluated and approved by Manitowoc.
- Do not use top of mast, boom, or jib as walkways unless they have catwalks.

NOTE: Catwalks are available from Manitowoc for boom and jib sections.

Two optional ladders, stored in 40 ft (12 m) insert next to the boom butt, are available for boom assembly and disassembly. See Boom Ladder Assembly in Section 4 for instructions.

GETTING ON OR OFF CRANE

Personnel getting on and off crane shall do so only at steps or ladders provided and only **while crane is parked**.

Never climb onto or off a moving crane. **Climb onto and off crane only when it is parked and only with operator's permission.**

When personnel use ladders to get on or off the crane, their hands shall be free of any objects. Objects which cannot be carried in pockets or tool belts shall be lifted into place with a hand line or hoist.

OPERATOR MANUAL/CAPACITY CHART STORAGE

General

Manitowoc provides the following manuals and other important literature with your crane and attachment (Luffing Jib, etc.):

- Operator Manual (Serial Numbered)
Contains safety information, crane specifications, assembly/erection procedures, operating instructions, lubrication and maintenance checks.
- Parts Manual (Serial Numbered)
Contains illustrations and part numbers of replaceable parts.
- Capacity Chart Manual (Serial Numbered)
Contains lifting capacities and related information (wire rope specifications, drum and lagging information, etc.)
- Maintenance Checks and Lube Guide
Contains lists of maintenance checks and lube services and their prescribed intervals.
- RCI/RCL Operation
Contains rated capacity indicator and/or rated capacity limiter operation, limits, and calibration procedures.
- Service Manual (Serial Numbered)
Contains theory of operation, maintenance procedures, crane and wire rope inspection procedures, troubleshooting information, and shop procedures.

The manuals which must be retained in the operator's cab (Operator Manual, Capacity Charts, Maintenance Checks and Lube Guide, and RCL Operation) are supplied in a OPERATOR INFORMATION binder. A separate binder is provided for the crane and each applicable attachment.

The Operator Manuals and Capacity Charts are stamped with the serial number of the crane or attachment. The serial number on the manuals and capacity charts must match the serial number of the crane and attachment in use. **Using any other manual or capacity chart is prohibited.**

- The crane model and serial number is located on the Crane Identification Plate on the crane cab.
- The model and serial number of the attachment (other than standard boom) is located on the Crane Identification Plate on the attachment.

If the serial numbers of your manuals and capacity charts do not match the serial numbers of the crane or attachment, contact your Manitowoc dealer for the proper manual or capacity charts.

Do not operate crane or attachment if proper Capacity Chart is not in cab.

Storing Manuals

Store the Operator Information Manuals for the crane and each applicable attachment on the bookshelf in the Operator's cab ([Figure 2-2](#)).

Attach the chain from the manual in use to the link behind the operator's seat.

Keep all other manuals provided with the crane in the crane owner's/user's office so they are readily available when needed.

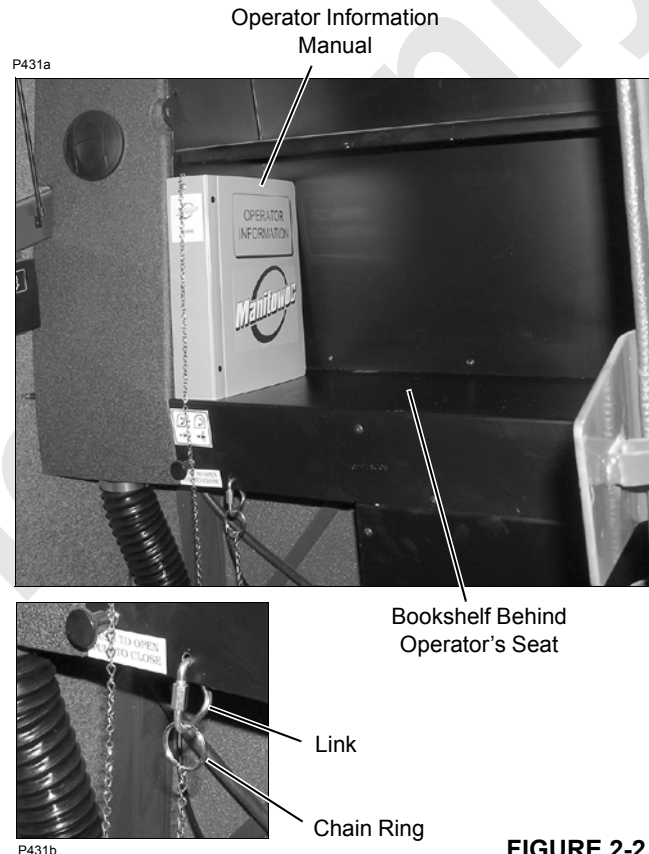

FIGURE 2-2

SWING RADIUS BARRIER

Manitowoc's optional swing radius barrier is shown in [Figure 2-3](#).

! WARNING Crush Hazard!

To prevent personnel from being crushed by swinging crane, deploy swing radius barrier before operating crane.

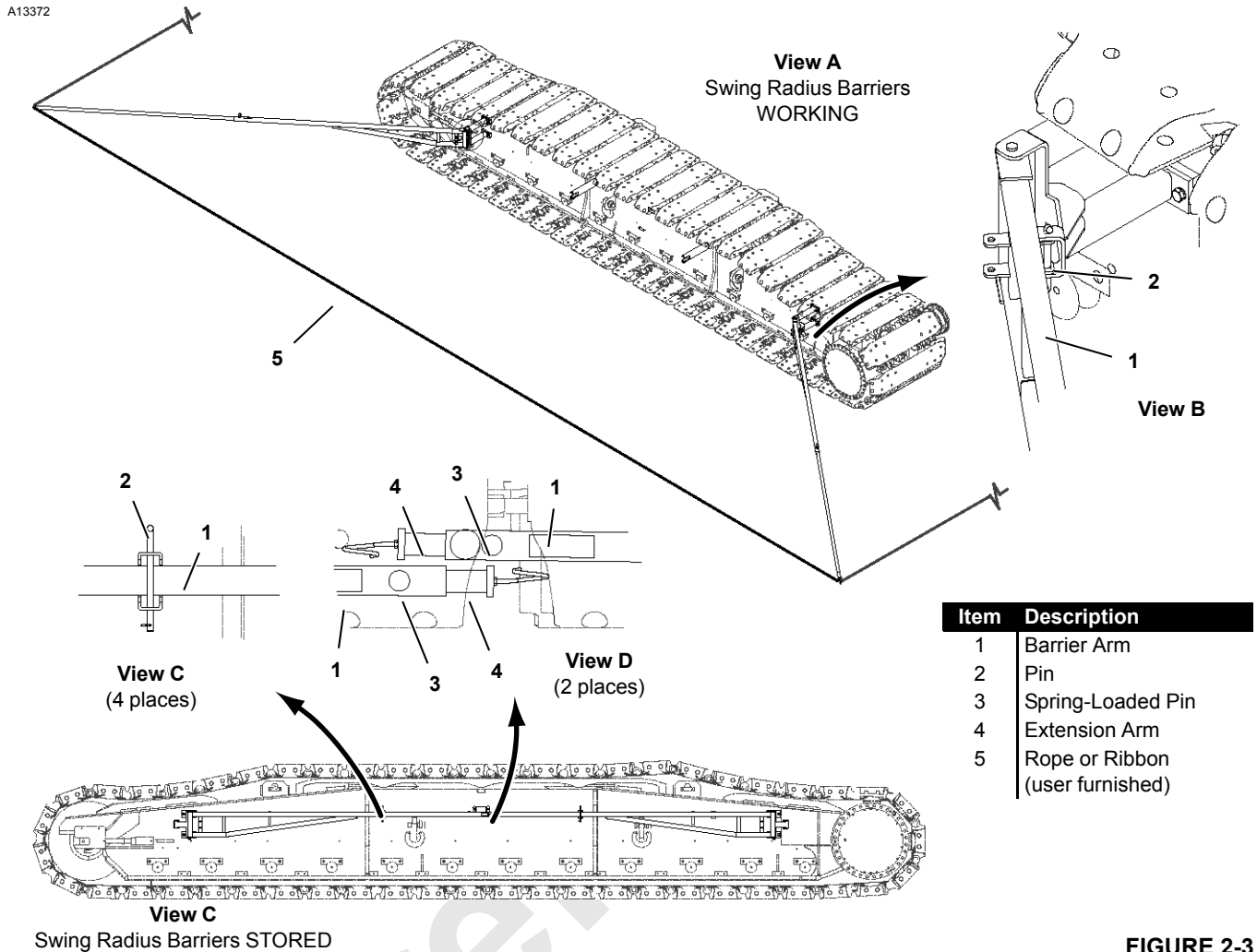

FIGURE 2-3

Deploying Swing Radius Barrier

1. Remove pins (2, View C) from shipping position.
2. Rotate barrier arms (1) outward to working position (View A).
3. Install pins (2, View B) in working position.
4. Pull on spring-loaded pins (3, View D), pull extension arms (4) out part way, and release pins.
5. Pull extension arms (4) out fully until they are locked in position by spring-loaded pins (5) as shown in View A.
6. Form a safety perimeter by attaching user supplied high visibility rope or ribbon to hooked ends of extension arms.

Storing Swing Radius Barrier

1. Remove rope or ribbon from hooked ends of extension arms (4).
2. Pull on spring-loaded pins (3, View D), push extension arms (4) in part way, and release pins.
3. Push extension arms (4) in fully until they are locked in position by spring-load pins (5).
4. Remove pins (2, View B) from working position.
5. Rotate barrier arms (1) inward and install pins (2, View C) in shipping position.

SAFE OPERATING PRACTICES

General

The importance of safe operation cannot be over emphasized. Carelessness and neglect on the part of operators, supervisors and planners, rigging personnel and job site personnel can result in their death or injury and costly damage to the crane or property.

The safety information in this publication is intended only as a guide to assist qualified operators, supervisors and planners, rigging personnel, and job site personnel in safe operation. Manitowoc cannot foresee all hazards that will arise in the field; therefore, **safety remains responsibility of crane operators and owner.**

Local, state, and other governmental agencies may require stricter operating practices. When a conflict in practices exists, follow the strictest practice.

Read Operator Manual

Safe and efficient assembly, disassembly, and operation of this crane requires that it be maintained in proper working order and that its operators and maintenance personnel be familiar with the crane's functions and capabilities.

The Operator Manual supplied with and considered part of your crane must be read and completely understood by each person responsible for assembly, disassembly, operation, and maintenance of the crane.

The Operator Manual must be read to personnel who can not read or understand English or other language into which the manual is translated.

Because of a program of continuing improvement in product design, Manitowoc reserves the right to change the information and specifications contained in the Operator Manual at any time without notice. If you have any questions regarding the crane or its Operator Manual, please contact your Manitowoc dealer.

Operator Qualifications

The crane shall be operated only by the following **qualified** personnel:

1. Designated operators.
2. Trainees under direct supervision of a designated operator.
3. Supervisors, inspectors, and maintenance or test personnel when necessary in performance of their duties. Operation of the crane by these personnel shall be limited to the crane functions needed to perform the inspection or to verify the crane's performance after maintenance procedures.

No personnel shall be allowed to climb onto crane or enter crane cab unless performance of their duties requires them to do so, and then only with knowledge of operator or other qualified person.

Qualified person is defined as one who by reason of training and experience is thoroughly familiar with crane operations and the hazards involved. Such a person shall meet the operator qualifications specified in Occupational Safety and Health Administration (OSHA) Regulations (United States Federal Law), in ASME B30.5 American National Standard, or in any other applicable federal, state, or local laws.

Operator training and qualification is crane owner's responsibility.

NOTE: The regulations and standards mentioned above and later in this section can be obtained from:

US DOL/OSHA Rules and Regulations are available by mail from the Superintendent of Documents, PO Box 371954, Pittsburgh, PA, 15250-7954 or by:

- Phone 202-512-1899
- Fax 202-512-2250
- Online at www.osha.gov

ASME (formerly ANSI) B30 Series American National Standards are available by mail from the ASME, 22 Law Drive, Fairfield, New Jersey, 07004-2900 or by:

- Phone US & Canada 800-843-2763
- Phone Mexico 95-800-843-2763
- Phone Universal 973-882-1167
- Fax 973-882-1717 or 973-882-5155
- E-mail infocentral@asme.org

Operator Conduct

1. The operator shall not engage in any practice which diverts his/her attention while operating the crane.
2. The operator shall not operate the crane when he/she is physically or mentally unfit.
3. The operator shall be responsible for all operations under his/her direct control. When safety of an operation is in doubt, the operator shall stop the crane's functions in a controlled manner. Lift operations shall resume only after safety concerns have been addressed or the continuation of crane operations is directed by the lift supervisor.
4. The operator shall be thoroughly familiar with operation of crane and its proper care. If adjustments or repairs are necessary or if there are known defects that impair safe

operation, the crane shall not be operated until unsafe conditions have been corrected.

5. If there is a warning sign at the start controls, the operator shall not start the engine until the warning sign has been removed by the person who installed it.
6. Before starting the engine, the operator shall make sure that:
 - a. All daily inspection and maintenance services have been performed.
 - b. All controls are in off the position and all brakes and locking devices are applied or engaged.
 - c. All personnel are clear of the crane. Deploy a swing radius barrier.



WARNING

Safety devices and operational aids such as rated capacity indicator or limiter, boom and jib angle indicator or limiter, anti-two-block device, level indicator, swing limiter, proximity device, etc., may be installed on your crane. Such devices are to be used only as **AIDS TO ASSIST OPERATOR**; their presence on crane in no way substitutes for or lessens requirement that operator knowledge, experience, and judgment are required to ensure safe operation of crane.

Crane shall not be loaded beyond applicable static or dynamic ratings given in Capacity Chart for crane.

- See Size of Load later in this section.
- For a description of each safety device and operational aid, see Safety Devices and Operational Aids in this section and Section 3.

7. The operator shall test all controls, limits, and communication systems at the start of each shift. Any defects found shall be corrected before operation is begun.
8. The operator shall not start crane movement if the load or designated signal person is not within his/her range of vision or communication.
9. The operator shall understand and respond to signals from the person directing the lift or from the designated signal person. When a signal person or crane follower is not required, the operator is responsible for the lift. **Operator shall obey a stop signal at all times, no matter who gives it.**
10. The operator shall verify that the Capacity Chart being used is the correct one for the cranes configuration (boom length, load line reeving, counterweight, etc.).
11. The operator shall verify that:

- a. All attachments are properly assembled and attached to the crane according to the rigging drawings called for in the Capacity Chart.
- b. The counterweight — to include applicable auxiliary counterweight — is in place and of proper weight. **Maximum required counterweight shall not be exceeded.**



WARNING

Moving Load/Tipping Crane Hazard!

Changing weather conditions including but not limited to: wind, ice or snow accumulation, precipitation, flooding, lightning, etc. should be considered when determining the location and configuration of a crane when it will be left unattended.

- c. The operator shall perform the following operations before leaving the operator's cab for any reason:
 - a. Park crane and position upperworks so crane does not interfere with operation of other equipment.
 - b. Apply travel and swing brakes or locking devices.
 - c. Land any attached load.
 - d. Lower the boom onto blocking at ground level or onto a boom rest if possible.

If the boom cannot be lowered, as determined by a qualified designated person, it must be securely fastened from movement by wind or other outside forces (see Wind Conditions in Capacity Chart Manual).

NOTE: The designated person must be familiar with the job site limitations, the crane configuration, and the expected weather conditions.

- e. Move all controls to off.
- f. Apply all drum brakes and pawls.
- g. Disengage the master clutch, if equipped.
- h. Stop the engine.

NOTE: Also read Unattended Crane instructions in Section 3 of the Crane Operator Manual.

12. The operator shall perform the following operations if power or a control function fails during operation:
 - a. Land all suspended loads, if possible, under brake or power control.
 - b. Apply all brakes and locking devices.
 - c. Move all controls to off.

13. If the crane will be operated at night, the operator shall make sure that there is sufficient lighting for safe operation. The load and landing area shall be illuminated.

14. The operator shall not operate the crane during periods of bad weather if his/her ability to see the load or the signal person is impaired by darkness, fog, rain, snow, and the like.

Do not operate the crane with a snow or ice covered boom. The extra weight may cause overload, tipping, or structural damage.

Never operate the crane during an electrical thunderstorm.

When a local weather storm warning exists (including electrical thunderstorm), stop operation and secure the crane. See step [c](#) under Operator Conduct topic.

NOTE: DO NOT depend on grounding. Grounding of a crane affords little or no protection from electrical hazards. The effectiveness of grounding is limited by the size of the conductor (wire) used, condition of the ground, the magnitude of voltage and current present, and numerous other factors.

15. Wind can cause the crane to tip or the boom and other attachments to collapse. The operator or qualified person directing the lift shall compensate for the effect of wind on the load and boom by reducing ratings, reducing operating speeds, or a combination of both.

Unless otherwise specified in the Capacity Chart, or in Operator Manual, stop operation under the following wind conditions:

- a. If the wind causes the load to swing forward past the allowable operating radius or sideways past either boom hinge pin, land the load and apply the drum brakes.
- b. If the wind exceeds 35 mph, land all loads and apply the drum brakes, lower the boom onto blocking at ground level or otherwise restrain it, and apply the swing and travel brakes and/or locks.

NOTE: *“Land load”* means to set it down on a firm uniformly supporting surface.

16. Booms, jibs, or masts which are being assembled or disassembled on the ground (with or without support of boom rigging) shall be securely blocked to prevent the boom, jib, or mast sections from dropping.

Workers shall not go under boom, jib, or mast sections when removing connecting pins or bolts.

17. Each outrigger shall be visible to the operator or the signal person during extension and retraction.

Handling Load

Size of Load

1. The crane shall not be loaded beyond the applicable static or dynamic ratings given in the Capacity Chart for the crane configuration.

NOTE: Capacity charts for Manitowoc cranes show the total weight of freely suspended loads for various boom and jib lengths and operating radii.

“Freely suspended load” is a load that is hanging free with no direct external force applied except by the crane’s load-line reeving.

To determine the actual weight of the load which can be lifted at a given radius (working load), the operator must deduct the weight of certain lifting equipment from the total weight given in the chart. See the specific Capacity Chart for your crane for a list of lifting equipment which must be deducted.

The operator’s judgment must be used to further reduce total the load to allow for the dynamic effects of swinging, hoisting, or lowering, and adverse weather conditions to include wind.

2. The operator or other designated person directing the lift shall verify that the weight of load is within the static or dynamic rating for radius at which load will be lifted.

Verified weights and measured radii shall take priority over RCI/RCL readings.

Attaching Load

1. Attach the hook to the load with slings, or other suitable rigging. Each hook shall have a latch that is in proper working order. **Hook latches shall not be wired open.**
 - a. Inspect each hook and latch before using.
 - b. Never use a hook or latch that is distorted or bent.
 - c. Make sure spring will force the latch against the tip of the hook.
 - d. Make sure the hook supports the load. The latch must never support the load. Latches are only intended to retain loose slings under slack conditions.
2. Only use slings and other rigging that are in safe operating condition and have a rating equal to or greater than the load to be lifted.
3. Do not wrap the load line around the load.
4. Use suitable protection between slings and any sharp edges on the load. When synthetic slings are used, the synthetic sling manufacturer’s instructions, limitations, specifications, and recommendations must be followed.

5. Secure unused legs of a multi-leg sling before handling a load with one leg of sling.

Lifting/Moving Load

1. Before lifting or moving a load, the operator or qualified person directing the lift shall make the following checks:

- a. Crane has a firm, uniformly supporting foundation under all crawlers. Unless otherwise specified in the Capacity Chart, the foundation shall be level to within 1% — 1ft (0,3 m) rise or fall in 100 ft (30,5 m) distance.

When such a surface is not available, it shall be provided with timbers, cribbing, or other structural members to distribute the load such that the allowable bearing capacity of the underlying member is not exceeded.

For ground bearing data go to:
www.manitowoccranes.com

- b. The load is secured and properly balanced in the slings or the lifting device before lifting the load more than 3 to 6 in (76 to 152 mm).
- c. The lift and swing paths are clear of personnel and obstructions.
- d. The load is free to be lifted.
- e. The load line is not kinked or otherwise damaged.
- f. Multiple part load lines are not twisted around each other in such a manner that the lines will not separate when the load is lifted.
- g. The hook is brought over the load in a manner that will minimize twisting or swinging.
- h. The load line and the boom hoist rope are properly spooled on the drums and seated in the sheaves.
- i. The load drum brakes are in proper working order.

The operator shall test the load drum brakes each time a load approaching the rated load is handled. Lift the load 3 to 6 in (76 to 152 mm) and fully apply the brakes — *load must not lower through applied brakes.*

- j. Unused load drums are parked (working and parking brakes applied; if equipped, drum pawls engaged).
- k. All personnel are clear of the swing radius of the crane's counterweight.

2. While lifting or moving the load, the operator shall take the following precautions:

- a. Accelerate and decelerate the load smoothly to avoid excessive stress on the crane boom and machinery.

- b. Avoid sudden starts and stops while swinging. Keep the swing speed under control to prevent the load from swinging out beyond the radius at which the load can be handled and to minimize the pendulum action of the load.

- c. Sound the signal horn before swinging and intermittently while swinging, especially when approaching personnel.

If equipped, the automatic swing alarm will sound when the crane is swung.

- d. Use taglines or other restraints to control the load when necessary.

- e. Do not exceed any swing limitations (areas of operation) given in the Capacity Chart.

- f. Do not allow the load, the boom, or any other part of the crane to contact obstructions.

- g. Do not use the crane to drag a load.

- h. Do not hoist, lower, or swing the load while personnel are on the load or the hook. See Personnel Handling in this section.

- i. Avoid carrying the load over personnel. Loads which are suspended shall be blocked or cribbed before personnel are allowed to work under or between them.

- j. Before lifting a load which requires the use of outriggers (or anytime outriggers are used), fully extend the outrigger beams and jacks so the truck tires do not bear any load.

Securely fasten the outrigger jack pads or floats to jacks and set them on a flat, firm surface that will support the load placed on the pads or floats. Do not set the jack pads or floats in holes, on rocky ground, or on extremely soft ground.

When dictated by ground conditions, install wood blocking or steel plates under the jack pads or floats to properly distribute the loading on the supporting surface.

Wood blocking or steel plates used under the jack pads or floats shall be:

- Free of defects.
- Strong enough to prevent crushing, bending, or shear failure.
- Of sufficient thickness, width, and length to completely support the jack pad or float, transmit the load to the supporting surface, and prevent shifting, toppling, or excessive settlement under load.

- k. Fully retract and lock the jacks and the outrigger beams so they cannot extend when not in use.

- I. Operate with extreme caution when using two or more cranes to lift the same load.

One designated person shall be responsible for operation when two or more cranes are used to lift same load. The designated person shall analyze the lift and instruct all personnel involved in proper rigging and positioning of the load and all movements to be made. Decisions such as the necessity to reduce crane ratings, load position, boom position, ground support, and speed of movements shall be in accordance with the designated person's decision.

- m. Do not lower the load or the boom to a point where less than three full wraps of wire rope are remaining on the respective drum (or as otherwise indicated in local, state, or federal regulations).
 - n. Engage the boom hoist pawl when operating with the boom at a fixed radius.
 - o. Engage the luffing hoist pawl when operating with the luffing jib at a fixed radius.
3. While traveling, the operator shall take the following precautions:
- a. Sound the signal horn before traveling and intermittently while traveling, especially when approaching personnel.
If equipped, the automatic travel alarm will sound when the crane is traveled.
 - b. Carry the boom in-line with the lowerworks and facing the direction of travel.
 - c. Do not position the boom so high that it could bounce over backwards whether traveling with or without load.
 - d. Secure the rotating bed against rotation except:
 - When operating with a MAX-ER® attachment.
 - When it is necessary to negotiate a turn, and then only when the operator is seated at controls or the boom is supported on a dolly.
 - e. Lash or otherwise restrain unused hooks so they cannot swing freely.
4. Before traveling with a load, the operator shall take the following additional precautions:
- a. A designated person shall be responsible for operation. Decisions such as the necessity to reduce crane ratings, load position, boom position, ground support, and speed of movements shall be in accordance with the designated person's decision.
 - b. Maintain specified tire pressures (truck cranes).

- c. Avoid sudden starts and stops. Use taglines or other restraints to control the position of the load.

Multiple Load Line Operation



WARNING

Avoid Over Load and Side Load Damage to Crane

Manitowoc highly recommends that you contact your Maniowoc dealer for lift planning assistance and approval.

Multiple load line operation is becoming common practice for applications like panel tilt-up, pile tilt-up, pile driving, rolling fabricated sections, etc. The multiple lines may be on a common shaft (each with different parts of line) or on multiple shafts (lower boom point and upper point, boom point and fixed jib point, etc).

Manitowoc authorizes multiple load line operation for those applications requiring it, provided the following steps are performed:

1. The qualified lift planner and the crane operator shall read and become thoroughly familiar with the appropriate Capacity Charts and Wire Rope Specification Charts.
2. The lift planner and the crane operator shall make sure the total load does not exceed the rated capacity given in the Capacity Chart and Wire Rope Specification Chart for given boom point or jib point, whichever is less.
EXAMPLE: If one load line is lifting from the jib point, the proper jib chart applies.
3. The crane shall be thoroughly inspected by a qualified person prior to setup.
4. The crane shall be thoroughly inspected for load line interference caused by routing and reeving of multiple load lines. If interference is found, it shall be eliminated.
5. For cranes produced before 2003, Rated Capacity Indicators/Limiters were not required by ASME B30.5 for non-personnel lifting.

To aid the operator in staying within the crane's Capacity Chart with the total applied load, Maniowoc recommends that its cranes be equipped with Rated Capacity Indicators/Limiters to monitor the load on each load line.

Operator is still responsible for knowing load and radius whether or not crane is equipped with load indicator(s).

6. Maniowoc recommends that each load line be equipped with an anti two-block device.

7. Manitowoc's Capacity Charts are based on freely suspended loads. To prevent side load damage to the boom, the jib, and the sheaves:
 - The load lines must hang as close to vertical as possible to minimize side and forward loads.

The distance between the load points and the hook points must be a minimum of three times the horizontal distance between the hook point on the load being lifted.
 - The load must remain centered on the boom and jib point shafts unless special lift approval is granted by Manitowoc.
 - The load lines should be located over the load's center of gravity as it is supported on a trailer, a barge, or the ground.
8. The crane operator must be familiar with the operational characteristic of the crane as it relates to multiple drum operation (simultaneous operation, same or opposite direction, or individual operation).
9. When using tandem drums, the maximum operating layers may be limited depending on whether the crane was initially designed for tandem drum operation or not.
10. Load shift when lifting with two hooks may be more unpredictable than typical one hook lifting.

Holding Load

When a load is suspended, the operator shall take the following precautions:

1. Not leave his/her position at the controls.
2. Not allow personnel to stand or pass under the load.
3. Move all controls to off, apply all drum brakes, engage the boom hoist pawl, and apply the swing and travel brakes or locks.

SIGNALS

1. Continuous communication shall be maintained between the operator and the signal person during all crane movements. If communication is disrupted, **operator shall stop all crane movements.**
2. Signals to the operator shall be in accordance with the standard signals shown in Section 3, unless communications equipment (telephone, radio, etc.) is used.
3. All signals shall be easily understood by the operator at all times. The operator shall not respond to any signal which is not clearly understood.
4. For operations not covered in the standard signals, or for special situations or emergencies, additional signals may be required. In those cases, the signals used shall be agreed upon in advance by the operator and the signal person. The signals used shall not conflict with or have potential to be confused with the standard signals.
5. When it is necessary to give instructions to the operator (other than those established by the signal system), all crane motions shall be stopped.
6. The signal person shall:
 - a. Be tested by a designated person and show that he or she has a basic understanding of crane operations and limitations, to include boom deflection.
 - b. Be thoroughly familiar with the standard hand signals and voice signals if used.
 - c. Be positioned in clear view of the operator. The signal person's position should give him or her a clear view of the load, the crane, and the operating area.
 - d. Direct the load so it does not pass over personnel.
 - e. Keep unnecessary personnel out of the crane's operating area.
7. When moving the crane, the following audible signals shall be used:
 - a. STOP - one short audible signal
 - b. GO AHEAD - two short audible signals
 - c. BACK UP - three short audible signals

SAFETY DEVICES



WARNING

Do not operate crane unless all safety devices listed in this section are in proper working order.

- If a safety device stops working properly during operation, the operator must safely stop operation.
- If any safety device listed in this section is not in proper working order, the safety device must be taken out of service and crane operation must not resume until the safety device is again working properly.
- Alternative measures are not permitted to be used for a faulty safety device.
- Always tag-out any faulty safety device and place a warning tag in the cab stating that the crane is out of service and must not be used.

Manitowoc provides the following safety devices on its cranes.

1. Horn activated by a switch on the control console in the operator's cab.
If the horn is not working properly, it must be tagged-out or removed, if possible.
2. Crane level indicator: either electronic (viewable in crane's electronic display) or mechanical (viewable from operator's cab seat). If the crane level indicator is not working properly, it must be tagged-out or removed, if possible.
3. Cranes operating on a barge require: a trim indicator, a swing brake, and a wind direction indicator if the wind is a factor (supplied by crane owner or user).
4. Boom stops, both physical and automatic.
If a boom stop is damaged or not working properly, it must be tagged-out or removed if possible.
5. Jib stops, both physical and automatic (for fixed jib and luffing jib).
If a jib stop is damaged or not working properly, it must be tagged-out or removed, if possible.
6. Pedal locks for all foot-operated brakes (if applicable).
If a pedal lock is damaged or not working properly, it must be tagged-out or removed if possible.
7. A integral holding device or check valve on each jacking cylinder.

OPERATIONAL AIDS



WARNING

Do not operate crane unless all applicable operational aids listed in this section are in proper working order, except:

- Where an operational aid is being repaired.
- The crane user implements a specified temporary alternative measure.

If an operational aid stops working properly during operation, the operator must safely stop operation until the temporary alternative measures are implemented or the device is again working properly.

Manitowoc provides the following operational aids on its cranes, either as standard equipment or optional equipment. The operational aids are designated as Category 1 or Category 2:

Category 1 Operational Aids

If a Category 1 operational aid is not working properly, it must be repaired no later than 7 calendar days after the deficiency occurs.

Exception: If the crane user documents that he/she has ordered the necessary parts within 7 calendar days of the occurrence of the deficiency, the repair must be completed within 7 calendar days of receiving the parts.

1. Boom or Luffing Jib Angle Limiter (automatic boom or jib stop)

Temporary alternative measures if inoperative or malfunctioning:

The qualified person directing the lift shall make sure the maximum boom or jib angle/radius specified in the Capacity Chart for the load being handled is not exceeded. One or more of the following methods must be used:

- a. Measure radius using a tape measure.
- b. Measure the boom angle with a protractor-level on the centerline of boom.
- c. Clearly mark the boom or luffing hoist cable (so it can easily be seen by the operator) at a point that gives the operator sufficient time to stop the boom or jib within the minimum allowable radius.

In addition, install mirrors or remote video cameras and displays if necessary for the operator to see the mark.

- d. Clearly mark the boom or luffing hoist cable (so it can easily be seen by a designated signal person) at a point that gives the signal person sufficient time to signal the operator and have the operator stop the boom or jib within the minimum allowable radius.

2. Anti-Two-Block Device

Temporary alternative measures if inoperative or malfunctioning:

The qualified person directing the lift shall establish procedures to furnish equivalent protection. One or more of the following methods must be used:

- a. Assign a signal person to signal the operator to stop hoisting when the load is a safe distance from the boom or jib point.
- b. Clearly mark the hoist cable (so it can easily be seen by the operator) at a point that will give the operator sufficient time to stop the load a safe distance from the boom or jib point.

NOTE: The temporary alternative measures for the anti-two-block device do not apply when lifting personnel in load line supported baskets. ***Personnel shall not be lifted in load line supported baskets when anti-two-block devices are not functioning properly.***

Category 2 Operational Aids

If a Category 2 operational aid is not working properly, it must be repaired no later than 30 calendar days after the deficiency occurs. Exception: If the employer documents that it has ordered the necessary parts within 7 calendar days of the occurrence of the deficiency, and the part is not received in time to complete the repair in 30 calendar days, the repair must be completed within 7 calendar days of receiving the parts.

1. Rated Capacity Indicator/Limiter

Temporary alternative measures if inoperative or malfunctioning:

The qualified person directing the lift shall establish procedures for determining load weights and shall make sure that the weight of the load does not exceed the crane's rating at the radius where the load is handled.

The weight of the load must be provided to the operator before the lift is made.

2. Boom Angle or Radius Indicator

Temporary alternative measures if inoperative or malfunctioning:

- a. Refer to the pendulum boom angle indicator on the boom butt (viewable from operator's cab).
- b. Measure the boom angle with a protractor-level on the centerline of boom.
- c. Measure radius using a tape measure.

3. Jib Angle or Radius Indicator

Temporary alternative measures if inoperative or malfunctioning. Use either or both:

- a. First, make sure you know the boom angle (see item 2 above).
- b. Then, measure radius using a tape measure.

4. Drum Rotation Indicator

Temporary alternative measures if inoperative or malfunctioning:

Mark the drum to indicate its rotation.

If the operator cannot see the drum, add mirrors or remote video cameras and displays so the operator can see the mark.

5. OPTIONAL Swing Limiter or Proximity Device

Temporary alternative measures if inoperative or malfunctioning:

The qualified person directing the lift shall establish procedures to furnish equivalent protection (for example, assign an additional signal person to observe the distance between the boom or load and job site obstructions to include power lines or to limit the swing sector specified in the Capacity Chart).

6. OPTIONAL Drum Spooling Limiter (maximum or minimum bail limit)

Temporary alternative measures if inoperative or malfunctioning:

The qualified person directing the lift, the operator, or a designated signal person shall watch the drum and signal the operator to stop it before it is over spooled (rope does not jump off drum) or before there are less than 3 full wraps of wire rope on the load drum or boom hoist.

7. OPTIONAL Closed-Circuit Television (CCTV)

Temporary alternative measures if inoperative or malfunctioning:

A designated signal person shall watch the load, the drums, and the counterweight and provide necessary hand or voice signals to the crane operator.

ASSEMBLING, DISASSEMBLING, OR OPERATING CRANE NEAR ELECTRIC POWER AND TRANSMISSION LINES

Electrocution Hazard

Thoroughly read, understand, and abide by all applicable federal, state, and local regulations regarding operation of cranes near electric power lines or equipment.

United States federal law prohibits the use of cranes closer than 20 ft (6 m) to power sources up to 350 kV and greater distances for higher voltages unless the line's voltage is known [29CFR1910.180 and 29CFR1926.1400].

To avoid death or serious injury, Manitowoc recommends that all parts of crane, boom, and load be kept at least 20 ft (6 m) away from all electrical power lines and equipment less than 350 kV.

NOTE: For detailed guidelines on operating near power lines, refer to the current edition of OSHA 29CFR1926.1400 and ASME B30.5 American National Standard.



WARNING

Electrocution Hazard!

Manitowoc cranes are not equipped with all features required to operate within OSHA 29CFR1926.1408, Table A clearances when the power lines are energized.

1. Keep all personnel and their personal belongings (clothing, water coolers, lunch boxes, etc.) away from the crane if it is being operated near electrical power lines or equipment.
2. Before operating the crane in the vicinity of electrical power lines or equipment, notify the power utility company. Obtain positive and absolute assurance that the power has been turned off.

The crane is NOT INSULATED. Always consider all parts of the load and the crane as conductors, including the wire rope, pendants or straps, and taglines.

Most overhead power lines ARE NOT insulated. Treat all overhead power lines as being energized unless you have reliable information to the contrary from the utility company or owner.

The rules in this section must be followed at all times, even if the electrical power lines or equipment have been de-energized.

3. Crane operation is dangerous when close to an energized electrical power source. Exercise extreme caution and prudent judgment. Operate slowly and cautiously when in the vicinity of power lines.
4. If the load, wire rope, boom, or any portion of the crane contacts or comes too close to an electrical power source, everyone in, on, and around the crane can be seriously injured or killed.

The safest way to avoid electrocution is to stay away from electrical power lines and electrical power sources.

5. The operator is responsible for alerting all personnel to the dangers associated with electrical power lines and equipment. The crane is not insulated. Do not allow unnecessary personnel in the vicinity of the crane while operating. Permit no one to lean against or touch the crane. Permit no one, including riggers and load handlers, to hold the load, load lines, taglines, or rigging gear.
6. Even if the crane operator is not affected by an electrical contact, others in the area may become seriously injured or killed.
7. It is not always necessary to contact a power line or power source to become electrocuted. Electricity, depending on magnitude, can arc or jump to any part of the load, load line, or crane boom if it comes too close to an electrical power source. Low voltages can also be dangerous.

Set-Up and Operation

1. During crane use, assume that every line is energized ("hot" or "live") and take necessary precautions.
2. Position the crane such that the load, boom, or any part of the crane and its attachments cannot be moved to within 20 ft (6 m) of electrical power lines or equipment. This includes the crane boom and all attachments. Overhead lines tend to blow in the wind, so allow for movement of the overhead lines when determining a safe operating distance.
3. Erect a suitable barricade to physically restrain the crane, all attachments, and the load from entering into an unsafe distance from electrical power lines or equipment.
4. Plan ahead and always plan a safe route before traveling under power lines. A wooden clearance frame should be constructed to ensure sufficient clearance is maintained between crane and power lines.
5. Appoint a reliable and qualified signal person, equipped with a loud signal whistle or horn and voice communication equipment, to warn the operator when any part of the crane or load moves near a power

source. This person should have no other duties while the crane is working.

6. Taglines should always be made of non-conductive materials. Any tagline that is wet or dirty can conduct electricity.
7. DO NOT store materials under power lines or close to electrical power sources.
8. When operating near transmitter/communication towers where an electrical charge can be induced into the crane or load:
 - The transmitter shall be deenergized OR,
 - Tests shall be made to determine if an electrical charge will be induced into the crane or load.
 - The crane must be provided an electrical ground.
 - If taglines are used, they must be non-conductive.
 - Every precaution must be taken to dissipate induced voltages. Consult with a qualified RF (radio frequency) Consultant. Also refer to local, state, and federal codes and regulations.

Electrocution Hazard Devices

1. The use of insulated links, insulated boom cages/guards, proximity warning devices, or mechanical limit stops does not ensure that electrical contact will not occur. Even if codes or regulations require the use of such devices, failure to follow the rules in this section may result in serious injury or death.
 2. Be aware that such devices have limitations and you should follow the rules and precautions outlined in this section at all times even if the crane is equipped with these devices.
 3. Insulating links installed into the load line afford limited protection from electrocution hazards. Links are limited in their lifting abilities, insulating properties, and other properties that affect their performance. Moisture, dust, dirt, oils, and other contaminants can cause a link to conduct electricity. Due to their capacity ratings, some links are not effective for large cranes and/or high voltages/currents.
 4. The only protection that may be afforded by an insulated link is below the link (electrically downstream), provided the link has been kept clean, free of contamination, has not been scratched or damaged, and is periodically tested (just before use) for its dielectric integrity.
 5. Boom cages and boom guards afford limited protection from electrocution hazards. They are designed to cover only the boom nose and a small portion of the boom. Performance of boom cages and boom guards is limited by their physical size, insulating characteristics, and operating environment (e.g. dust, dirt, moisture, etc.).
- The insulating characteristics of these devices can be compromised if not kept clean, free of contamination, and undamaged.
6. Proximity sensing and warning devices are available in different types. Some use boom point (localized) sensors and others use full boom length sensors. No warning may be given for components, cables, loads, and other attachments located outside of the sensing area. Reliance is placed upon the operator in selecting and properly setting the sensitivity of these devices.
 7. Never rely solely on a device to protect you and your fellow workers from danger.
- Some variables you must know and understand are:
- Proximity devices are advertised to detect the existence of electricity and not its distance, quantity, or magnitude.
 - Some proximity devices may detect only alternating current (AC) and not direct current (DC).
 - Some proximity devices detect radio frequency (RF) energy and others do not.
 - Most proximity devices simply provide a signal (audible, visual, or both) for the operator and this signal must not be ignored.
 - Sometimes the sensing portion of the proximity devices becomes confused by complex or differing arrays of power lines and power sources.
8. DO NOT depend on grounding. Grounding of a crane affords little or no protection from electrical hazards. The effectiveness of grounding is limited by the size of the (wire) conductor used, the condition of the ground, the magnitude of the voltage and current present, and numerous other factors.

Electrical Contact

If the crane comes in contact with an energized power source, the operator must:

1. Stay in the crane cab. DON'T PANIC.
2. Immediately warn PERSONNEL in the vicinity to STAY AWAY.
3. Attempt to move the crane away from the contacted power source using the crane's controls which are likely to remain functional.
4. Stay in the crane until the power company has been contacted and the power source has been de-energized. NO ONE must attempt to come close to the crane or load until the power has been turned off.

Only as a last resort should an operator attempt to leave the crane upon contacting a power source. If it is absolutely necessary to leave the cab, JUMP

COMPLETELY CLEAR OF CRANE. DO NOT STEP OFF. Hop away with both feet together. DO NOT walk or run.

- Following any contact with an energized electrical source, your Manitowoc dealer must be immediately advised of the incident and consulted on necessary inspections and repairs.

If the dealer is not immediately available, contact the Manitowoc Crane Care Lattice Team. The crane must not be returned to service until it is thoroughly inspected for any evidence of damage and all damaged parts are repaired or replaced as authorized by Manitowoc or your Manitowoc dealer.

REFUELING

- When using a portable container to refuel the crane, the container shall be a safety-type can equipped with an automatic closing cap and a flame arrester.
- The engine shall be **stopped** before refueling crane.
- Smoking and open flames shall be prohibited in refueling area.

FIRE EXTINGUISHERS

- A portable fire extinguisher with a minimum rating of 10 BC shall be installed in operator's or machinery cab of crane.
- The operator and all maintenance personnel shall be thoroughly familiar with the location, use, and care of the fire extinguisher(s) provided.

ACCIDENTS

If this crane becomes involved in a property damage and/or personal injury accident, immediately contact your Manitowoc dealer or the Product Safety and Reliability Department at the following address:

Manitowoc Cranes
2401 So. 30th St.
Manitowoc, WI 54220
Phone: 920-684-6621

Provide a complete description of the accident, including the crane model and serial number.

The crane must not be returned to service until it is thoroughly inspected for any evidence of damage. All damaged parts must be repaired or replaced as authorized by Manitowoc.

SAFE MAINTENANCE



WARNING

Importance of safe maintenance cannot be over emphasized. Carelessness and neglect on part of maintenance personnel can result in their death or injury and costly damage to the crane or property.

Safety information in this publication is intended only as a guide to assist qualified maintenance personnel in safe maintenance. Manitowoc cannot foresee all hazards that will arise in field; therefore, **safety remains responsibility of maintenance personnel and crane owner.**

Maintenance Instructions

To ensure safe and proper operation of Manitowoc cranes, they must be maintained according to the instructions contained in this manual and in the Service Manual provided with the crane.

Crane maintenance and repair must be performed by qualified personnel. These personnel must **read Operator Manual and Service Manual before attempting any maintenance procedure.** If there is any question regarding maintenance procedures or specifications, contact your Manitowoc dealer for assistance.

Qualified person is defined as one who by reason of training and experience is thoroughly familiar with the crane's operation and required maintenance as well as the hazards involved in performing these tasks.

Training and qualification of maintenance and repair personnel are crane owner's responsibility.

Safe Maintenance Practices

- Perform the following steps (as applicable) before starting a maintenance procedure:
 - Park the crane where it will not interfere with other equipment or operations.
 - Lower all loads to the ground or otherwise secure them against movement.
 - Lower the boom onto blocking at ground level, if possible, or otherwise secure the boom against dropping.
 - Move all controls to off and secure all functions against movement by applying or engaging all brakes, pawls, or other locking devices.
 - Stop the engine and render the starting means inoperative.

- f. Place a warning sign at the start controls alerting other personnel that crane is being serviced and the engine must not be started. **Do not remove sign until it is safe to return crane to service.**
2. Do not attempt to maintain or repair any part of the crane while the engine is running, unless absolutely necessary.
If the engine must be run, keep your clothing and all parts of your body away from moving parts. **Maintain constant verbal communication between person at controls and person performing maintenance or repair procedure.**
 3. Wear clothing that is relatively tight and belted.
 4. Wear appropriate eye protection and approved hard hat.
 5. Never climb onto or off a moving crane. **Climb onto and off crane only when it is parked and only with operator's permission.**
Use both hands and handrails, steps and ladders provided to climb onto and off the crane.
Lift tools and other equipment which cannot be carried in pockets or tool belts onto and off the crane with hand lines or hoists.
 6. The boom and gantry are not intended as ladders. Do not attempt to climb lattice work of the boom or gantry to get to maintenance points. If the boom or gantry is not equipped with an approved ladder, lower them before performing maintenance or repair procedures.
 7. Do not remove cylinders until the working unit has been securely restrained against movement.
 8. Pinch points are impossible to eliminate; watch for them closely.
 9. Pressurized air, coolant, and hydraulic oil can cause serious injury. Make sure all air, coolant, and hydraulic lines, fittings, and components are tight and serviceable.
Do not use your hands to check for air, coolant or hydraulic oil leaks:
 - Use a soap and water solution to check for air leaks (apply to fittings and lines and watch for bubbles).
 - Use a piece of cardboard or wood to check for coolant and hydraulic oil leaks.
 10. Relieve pressure before disconnecting air, coolant, and hydraulic lines and fittings.
 11. Do not remove the radiator cap while the coolant is hot or under pressure. Stop the engine, wait until the pressure drops and the coolant cools, then slowly remove the cap.
 12. Avoid battery explosion: do not smoke while performing battery maintenance or short across battery terminals to check its charge.
 13. Read the safety information in the battery manufacturer's instructions before attempting to charge a battery.
 14. Avoid battery acid contact with skin and eyes. If contact occurs, flush the area with water and immediately consult a doctor.
 15. Stop the engine before refueling crane.
 16. Do not smoke or allow open flames in refueling area.
 17. Use a safety-type can with an automatic closing cap and flame arrestor for refueling.
 18. Hydraulic oil can also be flammable. Do not smoke or allow open flames in the area when filling hydraulic tanks.
 19. Never handle wire rope with bare hands. Always wear heavy-duty gloves to prevent being cut by broken wires.
 20. Use extreme care when handling coiled pendants. Stored energy can cause the coiled pendants to uncoil quickly with considerable force.
 21. When inflating tires, use a tire cage, a clip-on inflater, and an extension hose which permits standing well away from the tire.
 22. Only use cleaning solvents which are non-volatile and non-flammable.
 23. Do not attempt to lift heavy components by hand. Use a hoist, jacks, or blocking to lift components.
 24. Use care while welding or burning on the crane. Cover all hoses and components with non-flammable shields or blankets to prevent a fire or other damage.
 25. To prevent damage to crane parts (bearings, cylinders, swivels, slewing ring, computers, etc.), perform the following steps **before welding on crane:**
 - Disconnect all cables from batteries.
 - Disconnect output cables at engine junction box.
 - Attach the ground cable from the welder directly to the part being welded and as close to the weld as possible.

Do not weld on the engine or engine mounted parts (per engine manufacturer).
 26. Disconnect and lock the power supply switch before attempting to service high voltage electrical components and before entering tight areas (such as carbody openings) containing high voltage components.
 27. When assembling and disassembling booms, jibs, or masts on the ground (with or without support of boom

rigging pendants or straps), securely block each section to provide adequate support and alignment.

Do not go under boom, jib, or mast sections while connecting bolts or pins are being removed.

28. Unless authorized in writing by Manitowoc, do not alter the crane in any way that affects the crane's performance (to include welding, cutting, or burning of structural members or changing pressures and flows of air/hydraulic components). Doing so will invalidate all warranties and Capacity Charts and make the crane owner/user liable for any resultant accidents.
29. **Keep crane clean.** Accumulations of dirt, grease, oil, rags, paper, and other waste will not only interfere with safe operation and maintenance but also create a fire hazard.
30. Store tools, oil cans, spare parts, and other necessary equipment in tool boxes. Do not allow these items to lie around loose in the operator's cab or on walkways and stairs.
31. Do not store flammable materials on the crane.
32. Do not return the crane to service at completion of maintenance or repair procedures until all guards and covers have been reinstalled, trapped air has been bled from hydraulic systems, safety devices have been

reactivated, and all maintenance equipment has been removed.

33. Perform a function check to ensure proper operation at the completion of maintenance or repair.

ENVIRONMENTAL PROTECTION

Dispose of waste properly! Improperly disposing of waste can threaten the environment.

Potentially harmful waste used in Manitowoc cranes includes — but is not limited to — oil, fuel, grease, coolant, air conditioning refrigerant, filters, batteries, and cloths which have come into contact with these environmentally harmful substances.

Handle and dispose of waste according to local, state, and federal environmental regulations.

When filling and draining crane components: do not pour waste fluids onto the ground, down any drain, or into any source of water.

- Always drain waste fluids into leak proof containers that are clearly marked with what they contain.
- Always fill or add fluids with a funnel or a filling pump.
- Immediately wipe up any spills.

Reference Only

THIS PAGE INTENTIONALLY LEFT BLANK

A10415

**View A
WRONG – DANGEROUS!**

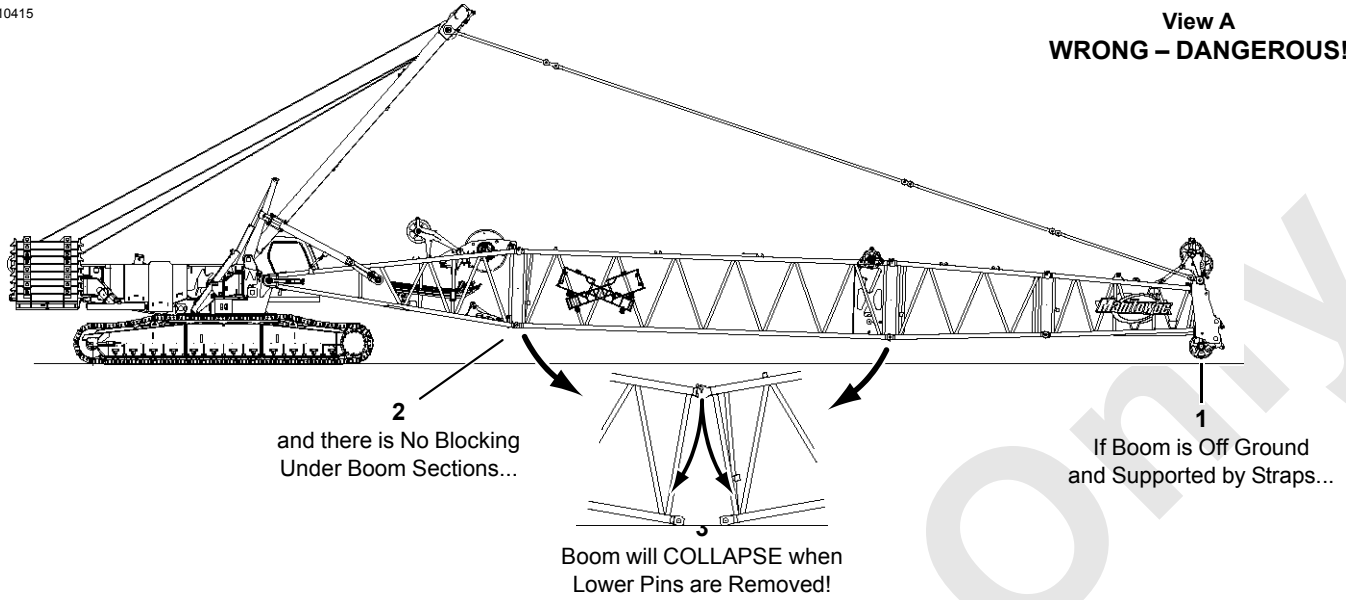

**View B
WRONG – DANGEROUS!**

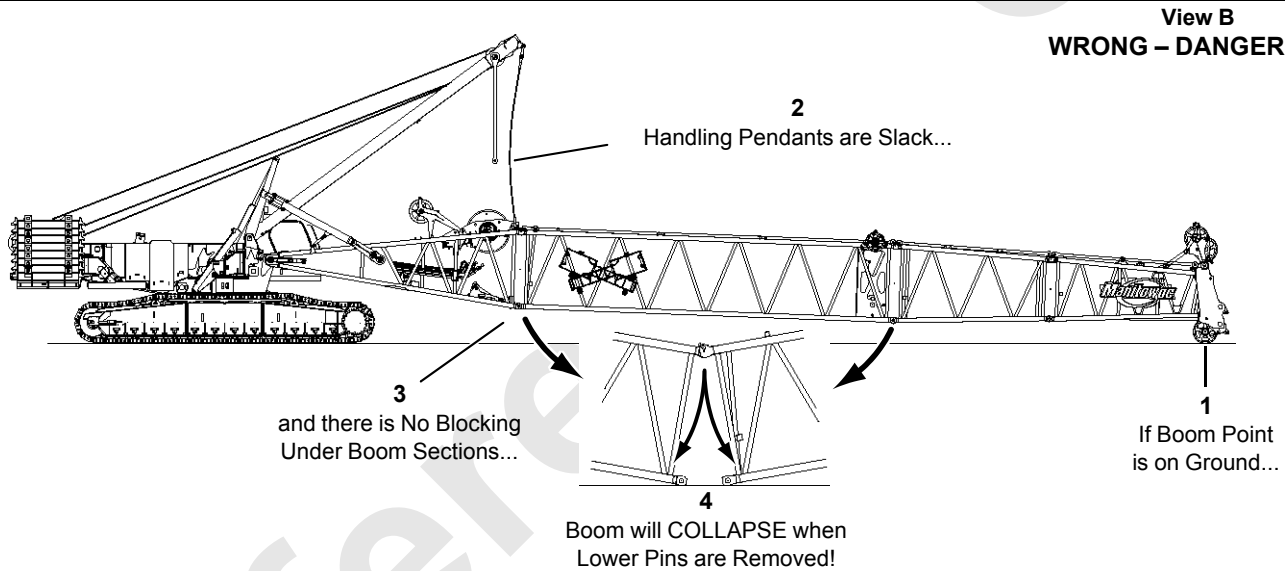

**View C
RIGHT – SAFE**

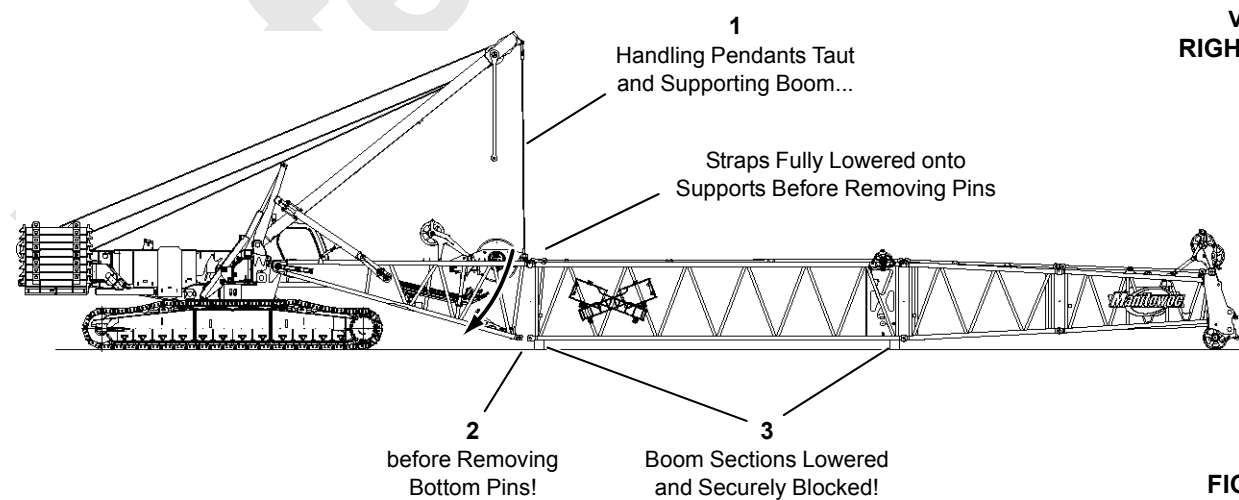

FIGURE 2-4

BOOM DISASSEMBLY SAFETY

NOTE: The term “boom” used in the following instructions applies to all lattice attachments (fixed jib, luffing jib, mast, etc.).



DANGER!

Collapsing Boom Hazard!

Prevent death or serious injury when disassembling boom sections — read and adhere to following instructions.

Safe handling of lattice booms during disassembly is a primary concern for preventing serious or fatal injuries. A boom can collapse during disassembly if workers fail to observe safe working practices.

Accidents during boom disassembly usually result from one of three primary causes:

- Workers are not familiar with equipment or are not properly trained.
- Disassembly area is not suitable.
- Safe procedures are overlooked because not enough time is allocated for the task.

General

Safety decals ([Figure 2-5](#)) are placed near the connectors on the boom sections as shown on the Boom Disassembly Decal Drawing at the end of this section.

Workers involved with boom disassembly must be trained and experienced in the operation and disassembly of construction cranes. Everyone must read and understand these instructions, the information in the Boom Assembly Drawing, and the instructions in Section 4 before beginning disassembly. Anyone who has a question should ask for an explanation. **One worker who does not fully understand or fails to follow correct procedures can endanger other workers.**

Location

Select a suitable location for boom disassembly. It must be firm, level, and be free of obstructions. It should have enough open space to accommodate the crane, the length of boom, and – if required – movement of an assist crane or other equipment. If possible, secure the area to keep unauthorized personnel and vehicles away.

Pin Removal

When removing pins from boom sections, stand clear of pins being removed. Even though the boom is resting on

blocking, individual pin connections may still be under load. Pins can be ejected forcefully if the boom has any pressure on it or if the boom is not supported properly.



FIGURE 2-5

Disassembly Precaution

Always block boom sections so they are securely supported and cannot shift or move suddenly when pins are removed. If there is any doubt about a boom disassembly procedure, **block tightly under boom sections before removing any pin.**



DANGER

Collapsing Boom Hazard!

Boom can collapse or jerk when pins are removed. To avoid death or serious injury:

- Do not remove bottom connecting pins from any boom section when boom is supported by straps as shown in [Figure 2-4](#), View A.
- Do not remove strap connecting pins until straps are fully lowered into supports as shown in [Figure 2-4](#), View C.
- Do not remove bottom connecting pins from any boom section when boom point is resting on ground and handling pendants are slack as shown in [Figure 2-4](#), View B.
- Never work or stand inside boom unless it is lowered and securely blocked as shown in [Figure 2-4](#), View C.
- Do not stand or walk on top of boom unless it has walkways.



DANGER

Falling Boom Hazard!

Crane can tip or boom can collapse if excess boom is cantilevered. Never cantilever more boom than allowed in rigging drawings or capacity charts.

PERSONNEL HANDLING POLICY

In 1998, the American Society of Mechanical Engineers issued a new American National Standard entitled, Personnel Lifting Systems, ASME B30.23-1998. This standard provides, ***“lifting and lowering of personnel using ASME B30 Standard hoisting equipment shall be undertaken only in circumstances when it is not possible to accomplish the task by less hazardous means. Unless all of the applicable requirements of this volume are met, the lifting or lowering of personnel using ASME B30 Standard equipment is prohibited.”***

The ASME Standards recognize that mobile and locomotive cranes are primarily designed and intended for handling materials and not personnel. The ASME Standards have a retrofit statement that applies to existing cranes after the standards go into effect. It is not the intent of the standards to require retrofitting of existing equipment. If an item is being modified, the performance requirement shall be reviewed relative to the current standard.

This new standard is consistent with the U.S. Department of Labor, Occupational Safety and Health Administration (OSHA) regulations for Construction that state, in 29CFR1926.1431(a): ***The use of a crane or derrick to hoist employees on a personnel platform is prohibited, except when the erection, use, and dismantling of conventional means of reaching the work site, such as a personnel hoist, ladder, stairway, aerial lift, elevating work platform or scaffold, would be more hazardous or is not possible because of structural design or work site conditions.***

Use of a Manitowoc crane to handle personnel is acceptable provided:

- The crane user shall comply with the manufacturer’s specifications and limitations for lifting accessories (hooks, slings, personnel platforms, etc.).
- The requirements of the applicable national, state and local regulations and safety codes are met.
- A determination has been made that use of a crane to handle personnel is the least hazardous means to perform the work.
- The crane operator shall be qualified to operate the specific type of hoisting equipment used in the personnel lift.
- The crane operator must remain in the crane cab at all times when personnel are off the ground.
- The crane operator and occupants have been instructed in the recognized hazards of personnel platform lifts.
- The crane is in proper working order.
- Load and boom hoist drum brakes, swing brakes, and locking devices such as pawls and dogs shall be

engaged when the occupied personnel platform is in a stationary position.

- The crane must be equipped with a boom angle indicator that is visible to the crane operator.
- The crane must be equipped with boom hoist limiting device.
- If the luffing jib is used for hoisting personnel, the crane must be equipped with a luffing jib angle indicator that is visible to the crane operator.
- If the luffing jib is used for hoisting personnel, the crane must be equipped with a luffing hoist limiting device.
- The crane is equipped with a positive acting device which prevents contact between the load block or overhaul ball and the boom tip (anti-two-block device).

For friction cranes, this implies the addition of spring applied brakes activated by the anti-two-block device. The load line hoist drum shall have a system or device on the power train, other than the load hoist brake, which regulates the lowering rate of speed of the hoist mechanism (controlled load lowering).

Free fall of the hoist line is prohibited.

- The crane’s Operator Manual is in the crane’s cab, readily accessible to the Operator.
 - The crane’s load Capacity Chart is affixed inside the crane cab, readily accessible to the operator. The total weight of the loaded personnel platform and related rigging shall not exceed 50 percent of the rated capacity for the radius and configuration of the crane.
 - The crane is uniformly level within one percent of level grade and located on a firm footing. Some Capacity Charts require more stringent levelness criteria.
- Cranes with outriggers or stabilizers shall have them all extended and locked. All outriggers or stabilizers must be extended equally in accordance with the Capacity Charts and operating procedures.
- Handling personnel from a platform suspended by wire rope from a luffing jib is acceptable, but only when it is not possible to accomplish the task using a less hazardous means. The crane user and operator shall take into account hazards that may be present when using a luffing jib.
 - Direct attachment of a personnel platform to a luffing jib is prohibited.
 - The platform meets the requirements as prescribed by applicable standards and regulations.
 - Applicable personal protection equipment is provided (i.e., personal fall-protection system, etc.)

- For wire rope suspended platforms, the crane is equipped with a hook latch that can be closed and locked, eliminating the throat opening.
- The platform is properly attached and secure.
- Personnel platforms must not be used in winds exceeding 20 mph (9 m/s) at the hoisted platform height or in electric storms, snow, ice, sleet, or other adverse weather conditions which could affect the safety of personnel.
- Hoisting personnel within 20 ft (6 m) of a power line that is up to 350 kV or within 50 ft (15 m) of a power line that is over 350 kV is PROHIBITED, except for work covered in OSHA 29CFR1926 subpart V.

For operation outside the United States, the requirements of the applicable national, state and local regulations and safety codes must be met. This may include, in addition to the above:

- Automatic brakes such that when the equipment operating controls are released, the motions are brought to rest.

- A holding device (such as a load hold check valve) shall be provided in the hydraulic or pneumatic systems to prevent uncontrolled movement of the hoisting equipment in the case of a system failure.

Manitowoc offers upgrade packages for friction controlled models to install anti-two-block, dead man control, and automatic hoist system control requirements to satisfy other codes and standards.

Manitowoc recommends that cranes be properly maintained, regularly inspected, and repaired as necessary. All safety signs must be in place and legible. We also urge Manitowoc crane owners to upgrade their cranes with rated capacity indicator/limiter systems for all lifting operations.

If you have any questions about this subject or other product safety matters relating to the operation and use of a Manitowoc crane, please contact your Manitowoc dealer or the Product Safety and Reliability Department at the following address:

Manitowoc Cranes
2401 So. 30th St.
Manitowoc, WI 54220
Phone: 920-684-6621

PEDESTAL/BARGE MOUNTED CRANES

WARNING Overload Hazard!

A pedestal mounted crane will not tip to indicate to operator that crane's capacity has been exceeded. When capacity of a pedestal mounted crane is exceeded, hook rollers or other structural components may break, before load lines fail, causing crane to separate from pedestal.

For this reason, great care must be taken to operate a pedestal mounted crane within its rated capacity.

Careful planning is required before a crane can be operated on a barge. Crane user shall verify that barge is capable of limiting crane list and/or dynamics to maximum allowable specified in Capacity Charts. If specified crane list and/or dynamic conditions are exceeded, crane's capacity may be exceeded; hook rollers or other structural components may break, causing crane to separate from pedestal.

WARNING

Crane owner/user must verify that method used to fasten or restrain crane to foundation, barge, ship or floating platform is strong enough, under all operating conditions, to prevent crane from breaking off foundation or moving on barge.

Manitowoc does not permit use of a truck crane on a barge, ship or floating platform.

Pedestal Mounted Crane

Also see ASME publication B30.8-2004, Floating Cranes and Derricks.

Definition

A pedestal mounted crane is a crane which is securely fastened to a foundation, barge, ship, or floating platform so the crane is restrained from tipping.

Examples

1. Crane rotating bed mounted on a turret (pedestal) which is securely fastened to the foundation ([Figure 2-6](#)).

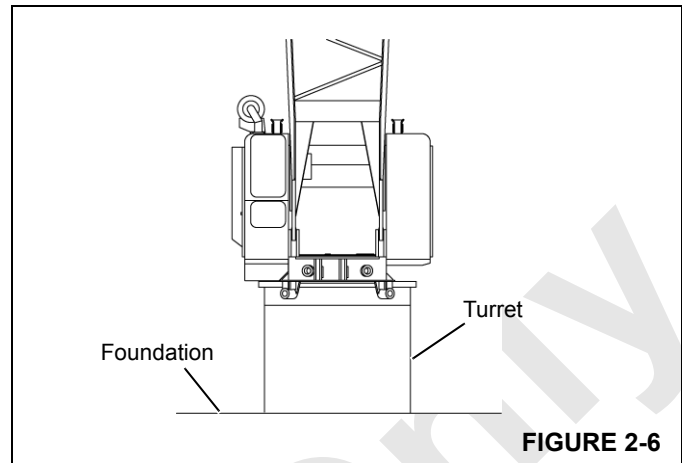
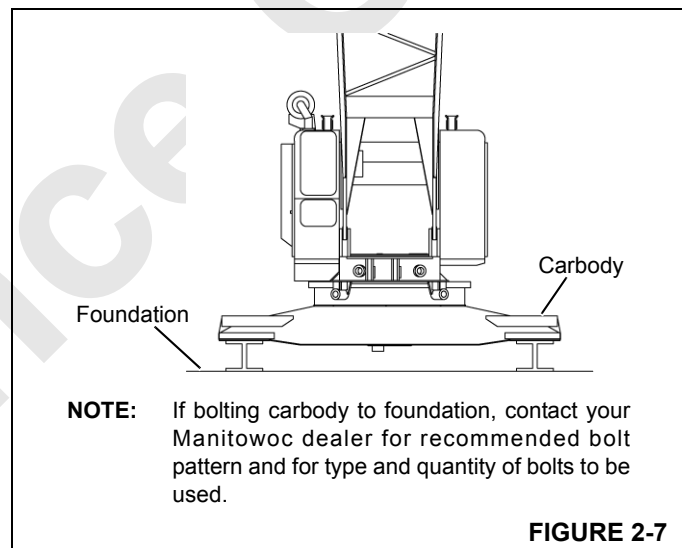

FIGURE 2-6

2. Crane rotating bed mounted on a carbody (crawlers removed) which is securely fastened to the foundation ([Figure 2-7](#)).



NOTE: If bolting carbody to foundation, contact your Manitowoc dealer for recommended bolt pattern and for type and quantity of bolts to be used.

FIGURE 2-7

Barge Mounted Crane

Definition

A barge mounted crane is a crane that is anchored or restrained in a work area of the barge, ship, or floating platform and is subjected to tipping forces.

Examples

NOTE: The foundation is the deck of the barge, ship, or floating platform.

1. Crawler-mounted crane with carbody anchored with tie-downs to the foundation ([Figure 2-8](#)).

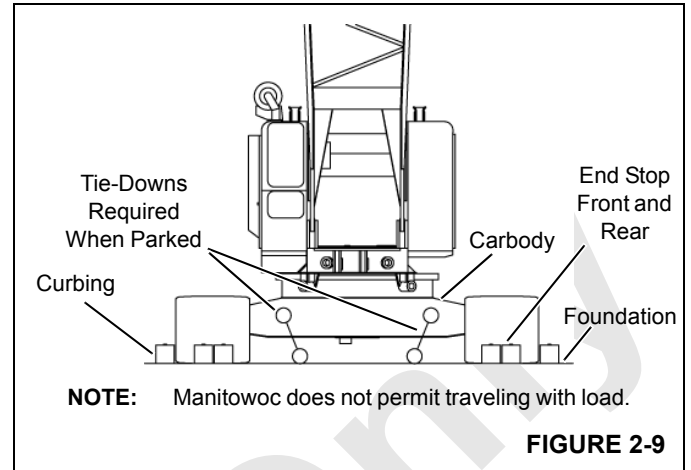
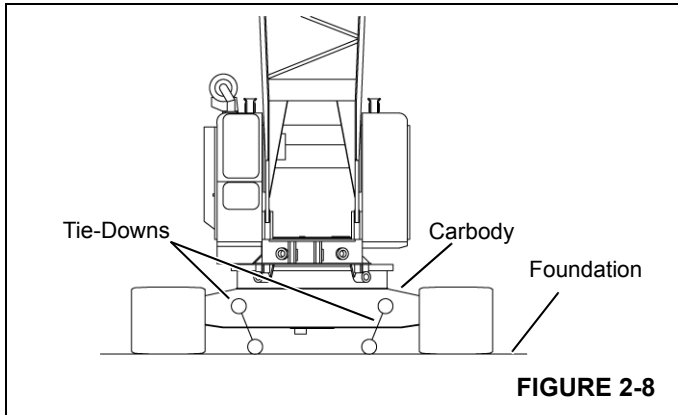

2. Crawler-mounted crane working on a timbered area of the barge, ship, or floating platform with the crawlers restrained by curbing and end stops (Figure 2-9). When not working, the crane carbody is anchored with tie-downs to the foundation. **Traveling with load is not permitted.**

- 3. RINGER® (crawler mounted, carbody mounted) supported on blocking, screw jacks, or steel pedestals which are braced and fastened to the foundation in such a manner as to prevent movement (Figure 2-10).
- 4. RINGER (platform mounted) which has the ring braced and fastened directly to the foundation in such a manner as to prevent movement.

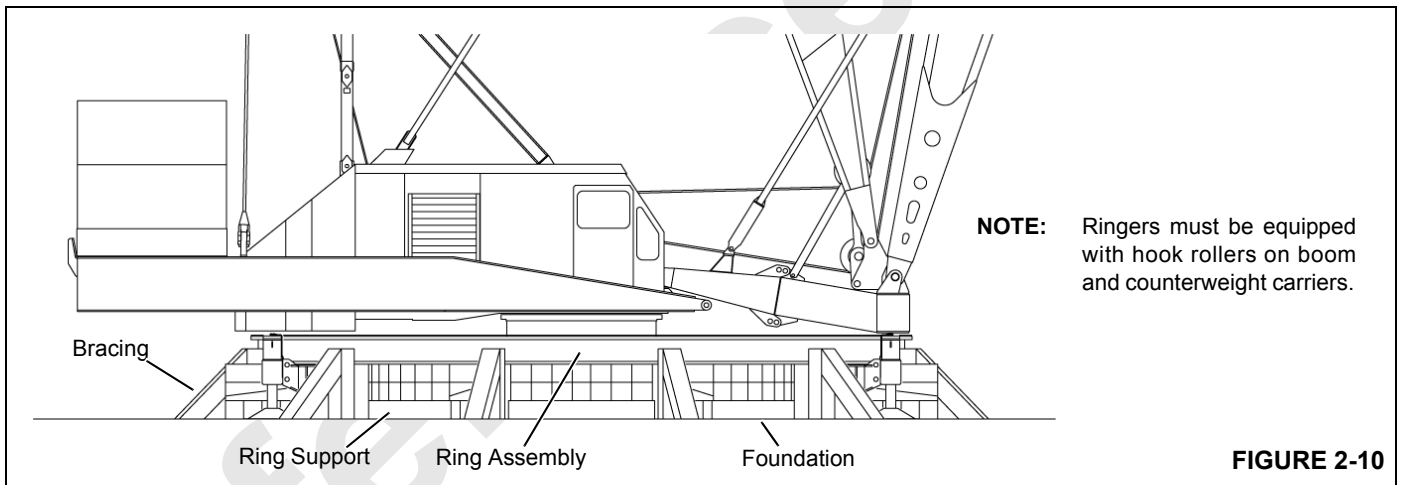

AXIS		TRANSITIONAL		ROTATIONAL	
SYMBOL	NAME	STATIC	DYNAMIC	STATIC	DYNAMIC
X	Longitudinal		Surge	Heel List	Roll
Y	Vertical		Heave		Yaw
Z	Lateral		Sway	Trim	Pitch

A 3D perspective diagram of a rectangular block. Three axes are shown: X (longitudinal), Y (vertical), and Z (lateral). Curved arrows indicate rotational movements around these axes: Roll around the X-axis, Yaw around the Y-axis, and Pitch around the Z-axis.

Capacity Charts

Manitowoc provides two types of Capacity Charts for a crane mounted on a barge or other supporting structure under static conditions.

1. A Capacity Chart based on tipping when the crane is anchored only to prevent shifting.
2. A Capacity Chart based on structural competence when crane is securely fastened for use as a pedestal mounted crane.

NOTE: Unless otherwise specified in a machine list Capacity Chart, a 0 degree machine list Capacity Chart rating applies to machine list **not to exceed 1/2 degree**. All other machine list ratings – 1°, 2°, and 3° – must NOT be exceeded.

Shock Loading

Definition

Shock loads to the crane can be experienced when the barge is subjected to up and down movement of wave action (referred to as DYNAMICS). [Figure 2-11](#) illustrates the dynamic conditions of the barge which influence crane capacity.

CAUTION

Structural Damage Hazard!

If crane boom or structure is shock loaded during operation, or there is any indication of shock loading, all structural components of crane shall be inspected to detect cracks and other damage. Nondestructive test equipment, such as magnetic particle or ultrasonic procedures, is recommended for this inspection.

NOTE: Manitowoc does not recommend crane operation under dynamic conditions.

Operation On Barge

General

Machine list and/or dynamics will be experienced when a crane is operated on a barge, ship, or floating platform. Both of these conditions reduce the crane's capacity and each

must be taken into account for safe operation on a barge, ship, or floating platform.



WARNING

Tipping Crane Hazard!

Tie-downs which only prevent crane from shifting as in barge, ship or floating platform mounting, may not provide adequate support when using a Capacity Chart for pedestal mounting. Before operating a crane on a barge, ship or floating platform, crane user shall verify that correct Capacity Chart is being used — pedestal mounted, barge mounted, 0°, 1°, 2° or 3° list or dynamic Capacity Chart.

Failing to use correct Capacity Chart can result in an accident.

Definitions

1. Machine List, as defined by Manitowoc, is the crane's out-of-level condition — from side-to-side — as measured by the angle between horizontal and a line drawn through the centerline of the crane's boom hinge pins ([Figure 2-12](#)). This out-of-level condition creates side load and affects the crane's lifting capacity.
2. Barge List (also referred to as heel or trim) causes swing out of the load and may produce side load. When Manitowoc provides a Capacity Chart showing capacities for a 2 degree machine list for example, we are referring to the maximum allowable lifting capacity for the crane when experiencing an out-of-level condition (side-to-side) of 2 degrees as measured by angle between horizontal and a line drawn through centerline of the crane's boom hinge pins.

Unless otherwise specified in the Capacity Chart, barge list (heel or trim) must not exceed the machine list degrees given in the Capacity Chart.
3. Barge List and Machine List are not same. As the crane rotates on a barge, barge list (as defined above) will change. The worst machine list condition generally occurs when the crane swings over the corner of the barge, producing maximum side load.

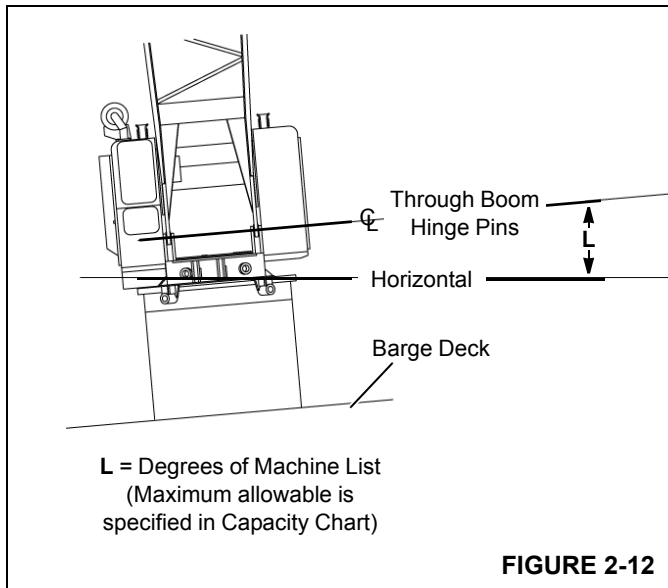

Crane Inspection

To aid in preventing harmful and damaging failure as previously indicated, regular inspection for signs of overloading in the following load bearing components is required. Correct each defect found before placing the crane into service.

- Boom
- Counterweight

- Backhitch
- Rotating Bed
- Wire Rope
- Pendants and Straps
- Hook and House Rollers

When equipped with hook rollers, it is recommended that each hook roller assembly be inspected daily for any sign of overloading, to include:

- Deformation of roller path
- Proper hook roller adjustment
- Deformation or cracks in hook roller hanger
- Bent hook roller shaft
- Damaged bearings

Transporting Crane on Barge

If it is necessary to transport the crane on a barge, ship, or floating platform when dynamic conditions will be experienced, the boom shall be lowered onto a cradle (or other support) and the crane's boom, rotating bed, and lowerworks shall be secured against movement. If the crane is equipped with a mast, the mast shall be securely tied down with guylines. Failing to take these steps can result in shock load or side load damage to the boom and mast.

THIS PAGE INTENTIONALLY LEFT BLANK

Reference Only

SECTION 3

OPERATING CONTROLS AND PROCEDURES

TABLE OF CONTENTS

Standard Hand Signals for Controlling Crane Operations	3-2
Symbol Identification	3-4
Front Window Operation	3-10
Closing Window	3-10
Opening Window For Ventilation	3-10
Opening Window For Emergency Exit	3-10
Operating Controls	3-10
General	3-10
Cab Door Damper Adjustment	3-11
Closing Cab Door	3-11
Damper Adjustment	3-11
Controls Identification And Function	3-13
A – Engine Controls	3-13
A1. Engine Ignition Switch	3-13
A2. Engine Emergency Stop Switch	3-13
A3. Engine Hand Throttle	3-13
A4. Engine Foot Throttle	3-13
A5. Engine Clutch Lever	3-13
A6. Battery Disconnect Switch	3-13
B – Accessory Controls	3-14
B1. Crane Work or Drum Lights Switch	3-14
B2. Overhead Windshield Wiper Switch	3-14
B3. Front Windshield Wiper-Washer Switch	3-14
B4. Climate Control	3-15
B5. Radio/CD Player (optional)	3-15
B6. Cab Tilt Switch	3-15
B7. Panel Lights Switch	3-15
B8. Dome Light Switch	3-15
B9. Horn Switches	3-15
B10. Cigarette Lighter	3-15
B11. 12 Volt Power Supply Receptacle	3-15
B12. Machinery Heaters	3-15
B13. Tinted Visor and Shade	3-16
B14. Air Ventilation Knob	3-16
B15. Fire Extinguisher	3-17
B16. Cab Door Brake	3-17
C – Indicators	3-17
C1. Boom Angle Indicator	3-17
C2. RCL Alarm (optional)	3-17
C3. Rear View Mirrors	3-17
C4. Bubble Level	3-17
C5. Wind Speed Transmitter	3-17
C6. Fuel Level	3-19
C7. Engine Coolant Temperature	3-19
C8. Engine Oil Pressure	3-19
C9. Battery Voltage	3-19
C10. Drum Rotation Indicators	3-19
C11. Drum Direction Indicators	3-19
D – Special Controls	3-19
D1. RCL Display and Indicator Lights	3-19
D2. Main Display	3-19

D3. Limit Bypass Switch	3-19
D4. Luffing Jib Limit Bypass Switch	3-19
D5. Seat Switch	3-19
D6. DPF Switch (Tier 4 Equipped)	3-19
D7. BRS Jack Switch (Optional)	3-19
Luffing Jib Setup Mode	3-23
E – Boom/Mast Hoist Controls	3-25
E1. Drum 4 (Boom/Mast Hoist) Park Switch	3-25
E2. Drum 5 (Boom Hoist) Park Switch	3-25
E3. Drum 4 or 5 (Boom/Mast Hoist) Handle	3-25
E4. Drum Indicator	3-25
F – Load Drum Controls	3-25
F1. Drum 1 Park Switch	3-25
F2. Drum 2 Park Switch	3-25
F3. Drum 3 Park Switch	3-25
F4. Drum 1 Handle	3-25
F5. Drum 2 Handle	3-25
F6. Drum 3 Handle	3-25
F7. Drum Indicator	3-25
G – Swing Controls	3-26
G1. Swing Park Switch	3-26
G2. Swing Handle	3-26
G3. Swing Holding Brake Switch	3-27
H – Travel Controls	3-27
H1. Travel Park Switch	3-27
H2. Travel Speed Selector	3-27
H3. Travel Cruise Selector	3-27
H4. Left Crawler Handle	3-27
H5. Right Crawler Handle	3-27
J – Winch Controls	3-27
Rigging Winch Mode	3-27
Limit Devices	3-28
Boom Up Limit	3-28
Block-Up Limit	3-28
Luffing Jib Up Limit	3-28
Luffing Jib Down Limit	3-29
Minimum Bail Limit	3-29
MAX-ER® Mast Stop Retracted	3-29
Seat Controls	3-30
Preparing Crane for Operation	3-31
Operation	3-32
Engine Startup	3-32
Boom/Mast Hoist Operation	3-34
Luffing Hoist Operation	3-35
Swing Operation	3-36
Load Drum Operation	3-37
Travel Operation	3-38
Stopping Engine/ Leaving Crane Unattended	3-40
Remote Controls	3-41
General	3-41
Remote Control Priority	3-41
Wireless Remote Controls	3-42
Wired Remote Controls	3-43
Crane Setup Remote Control Activation	3-44
Wireless Remote Control	3-44
Wired Remote Control	3-44
Crane Setup Remote Controls Operation	3-45

1–Power Switch	3-45
1a–Power Light (Wireless Remotes Only)	3-45
2–Stop Switch	3-45
3–Left Front Jacking Toggle Switch	3-45
4–Right Front Jacking Toggle Switch	3-45
5–Left Rear Jacking Toggle Switch	3-45
6–Right Rear Jacking Toggle Switch	3-45
7–All Jacking Toggle Switch	3-45
8–Boom Pins Switch	3-46
9–Front Rotating Bed Pins Switch	3-46
10–Rear Rotating Bed Pins Switch	3-46
11–Counterweight Pins Switch	3-46
12–Engine Speed Switch	3-46
13–Mast Switch	3-46
14–Cab Raise/Lower Switch	3-46
Carbody Remote Controls Operation	3-47
15–Right Crawler Pin Handle	3-47
16–Left Crawler Pin Handle	3-47
17–Right Front Carbody Jack Handle	3-47
18–Right Rear Carbody Jack Handle	3-47
19–Left Rear Carbody Jack Handle	3-47
20–Left Front Carbody Jack Handle	3-47
21–Carbody Level	3-47
Wireless Remote Battery Replacement	3-47
Displays	3-48
Display Controls	3-48
1 – Rated Capacity Indicator (RCI) Display	3-48
2 – Main Display	3-48
3 – Display Touchpad Controls	3-48
4 – RCI Select Buttons	3-48
5 – Select Buttons	3-48
6 – Enter/Exit Buttons	3-48
7 – Confirm Button	3-48
Display Brightness and Color Contrast	3-48
Restore Factory Default Display Settings	3-48
Blank Display	3-48
Main GUI Display Format	3-49
Screen Prompts	3-49
Menu Screen	3-49
Information Screen	3-50
Crane Level	3-50
Boom to Luffing Jib Working Angle	3-50
Wind Speed Indicator	3-50
Mast Angle	3-50
Hydraulic Tank	3-50
Battery	3-50
Pump Drive	3-50
Engine	3-50
MAX-ER® (Optional)	3-51
Faults	3-51
Tier 4 Engine	3-51
Diagnostic Screen	3-53
Diagnostic Screen Component Icons	3-53
Tier 4 Engine Diagnostic Information	3-55
Swing Diagnostic Screen	3-56
Travel Diagnostic Screen	3-56
Jacking Accessory Diagnostic Screen	3-57

Pins and Fan Accessory Diagnostic Screen	3-57
Cab Tilt, Rigging Winch, and Mast Accessory Diagnostic Screen	3-58
MAX-ER® Diagnostic Screen	3-58
Function Mode Screens	3-59
Drum Functions	3-59
Swing Functions	3-59
Travel Functions	3-59
Setup Remote Functions	3-59
MAX-ER® Functions	3-59
Drum, Swing or Track Speed Limits	3-59
Swing Pressure Limit	3-60
Rigging Winch Mode	3-60
Boom or Swing Motion Limiter Mode	3-60
Setup Remote Control Mode	3-60
Fan Function	3-60
CAN Bus Screen	3-62
Packet Information	3-62
Digital Output Disable Fault	3-62
Engine Node Status	3-62
Crane Status	3-62
Load Link Status	3-63
Wireless Receiver Status	3-63
Boom Node Status	3-63
Digital Output Reference Chart	3-65
Digital Input Reference Chart	3-66
Camera Screen (Optional)	3-69
Pressure Test and Calibration Screen	3-69
Pressure Sender Test	3-69
Control Calibration	3-70
High Pressure Test	3-71
Charge Pressure Test	3-72
Wind Conditions	3-73
Preparation for Cold Weather	3-75
Crane Limitations	3-75
Wire Rope	3-75
Cold Weather Starting Aid	3-75
Coolant and Oil Pan Heaters	3-75
Cooling System	3-75
Battery	3-75
Engine Oil	3-75
Fuel Oil	3-75
Gear Oil	3-75
Hydraulic Cranes	3-75
Hydraulic Oil	3-76
General	3-76
Cold Weather Heater Package	3-76
General	3-76
Heaters	3-76
Past Production Cold Weather Package	3-76
Current Production Cold Weather Package	3-76
Turning Heaters On	3-76
Turning Heaters Off	3-76
Circuit Breakers	3-77
Past Production Cold Weather Package	3-78
Current Production Cold Weather Package	3-79

**SECTION 3
OPERATING CONTROLS AND PROCEDURES**









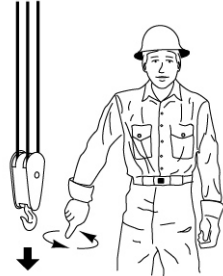
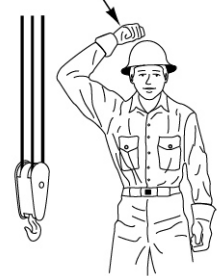
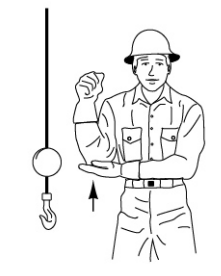

Reference Only

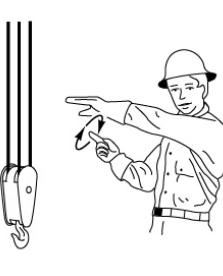
THIS SECTION STARTS ON THE NEXT PAGE

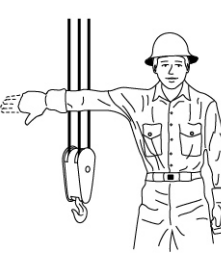
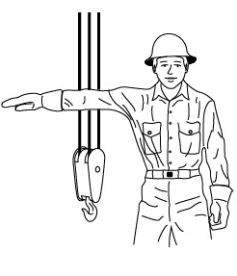
STANDARD HAND SIGNALS FOR CONTROLLING CRANE OPERATIONS

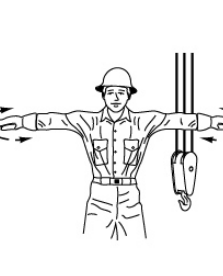
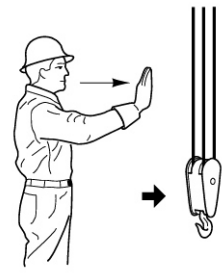
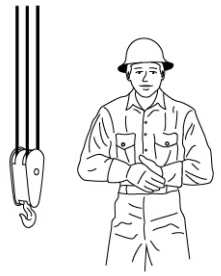
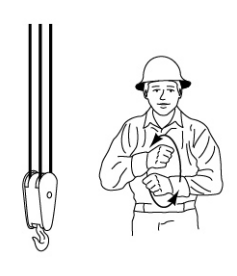
The following standard hand signals comply with ASME B30.5-2014.

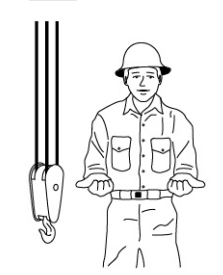
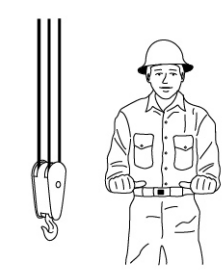
Table 3-1 Standard Hand Signals For Controlling Crane Operations

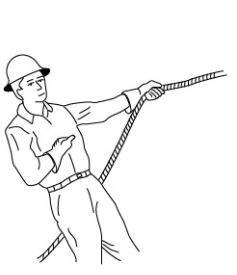
<p style="text-align: center;">1</p>  <p>M100118</p>	<p style="text-align: center;">2</p>  <p>M100119</p>	<p style="text-align: center;">3</p>  <p>M100120</p>	<p style="text-align: center;">4</p>  <p>M100121</p>	<p style="text-align: center;">5</p>  <p>M100122</p>
<p style="text-align: center;">6</p>  <p>M100123</p>	<p style="text-align: center;">7</p>  <p>M100124</p>	<p style="text-align: center;">8</p>  <p>M100125</p>	<p style="text-align: center;">9</p>  <p>M100126</p>	<p style="text-align: center;">10</p>  <p>M100127</p>
<p style="text-align: center;">11</p>  <p>M100128</p>	<p style="text-align: center;">12</p>  <p>M100129</p>	<p style="text-align: center;">13</p>  <p>M100130</p>	<p style="text-align: center;">14</p>  <p>M100131</p>	<p style="text-align: center;">15</p>  <p>M100132</p>
<p style="text-align: center;">16</p>  <p>M100133</p>	<p style="text-align: center;">17</p>  <p>M100134</p>	<p style="text-align: center;">18</p>  <p>M100135</p>	<p style="text-align: center;">19</p>  <p>M100136</p>	<p style="text-align: center;">20</p>  <p>M100137</p>

Reprinted from *ASME B30.5-2014*, by permission of the American Society of Mechanical Engineers. All Rights Reserved.

Item	Description
1	HOIST —With forearm vertical, forefinger pointing up, move hand in small horizontal circles.
2	LOWER —With arm extended downward, forefinger pointing down, move hand in small horizontal circles.
3	USE MAIN HOIST —Tap fist on head. Then use regular signals.
4	USE WHIPLINE (Auxiliary Hoist) —Tap elbow with one hand. Then use regular signals.
5	RAISE BOOM —Arm extended, fingers closed, thumb pointing upward.
6	LOWER BOOM —Arm extended, fingers closed, thumb pointing downward.
7	MOVE SLOWLY —Use one hand to give any motion signal and place other hand motionless in front of hand giving the motion signal (hoist slowly shown as an example).
8	RAISE BOOM & LOWER LOAD —With arm extended, thumb pointing up, flex fingers in and out as long as load movement is desired.
9	LOWER BOOM & RAISE LOAD —With arm extended, thumb pointing down, flex fingers in and out as long as load movement is desired.
10	SWING —Arm extended, point with finger in direction of swing of boom.
11	STOP —Arm extended, palm down, move arm back and forth horizontally.
12	EMERGENCY STOP —Both arms extended, palms down, move arms back and forth horizontally.
13	TRAVEL —Arm extended forward, hand open and slightly raised, make pushing motion in direction of travel.
14	DOG EVERYTHING —Clasp hands in front of body.
15	TRAVEL (Both Tracks) —Use both fists in front of body, making a circular motion about each other, indicating direction of travel forward or backward. (For Land Cranes Only).
16	TRAVEL (One Track) —Lock the track on side indicated by raised fist. Travel opposite track in direction indicated by circular motion of other fist, rotated vertically in front of body. (For Land Cranes Only).
17	EXTEND BOOM (Telescoping Booms) —Both fists in front of body with thumbs pointing outward.
18	RETRACT BOOM (Telescoping Boom) —Both fists in front of body with thumbs pointing toward each other.
19	EXTEND BOOM (Telescoping Boom) —One Hand Signal. One fist in front of chest with thumb tapping chest.
20	RETRACT BOOM (Telescoping Boom) —One hand signal. One fist in front of chest, thumb pointing outward and heel of fist tapping chest.

SYMBOL IDENTIFICATION

The following symbols are used on the control consoles to identify the operating controls and their operation.











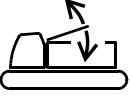
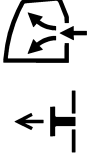

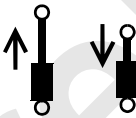

Air Circulation – Cab		Cylinders – Live Mast	
Air Circulation – Outside		Data, Enter	
Alert, Safety		Data, Save Entered	
Cab Tilt		Drum	
Cylinders, Live Mast – Extend or Retract		Drum – Lower (Load, Boom, Luffing Jib, or Mast) (depends on drum use.)	
Cylinders, Jacking – Extend or Retract		Drum – Raise (Load, Boom, Luffing Jib, or Mast) (depends on drum use.)	
Cylinders, Jacking – Location	<p>Left Front </p> <p>Right Front </p> <p>Left Rear </p> <p>Right Rear </p> <p>All </p>	Drum Free Fall (with drum number)	
		Drum Number (identifies drum is in use)	

FIGURE 3-1

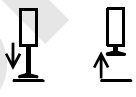
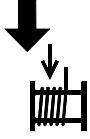



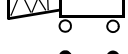
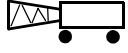
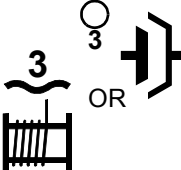













Energize (turn on)		Engine Temperature	
Engine		Heater/Defroster	
Engine, Battery Voltage		Horn	
Engine, Fuel		Light, Panel	
Engine Pressure		Light, Dome	
Engine Run		Lighter	
Engine Start		Limit Bypass	
Engine Stop		Limit Bypass, Luffing Jib	
Engine (Tier 4)			
DPF High Temperature			
DPF Regen On			
DPF Inhibit On			

FIGURE 3-1 continued











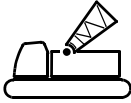











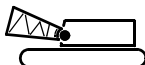















On/Start and Off/Stop		Pins – Main Mast	
Off/Stop		Pins – Rotating Bed Front	
On/Start		Pins – Rotating Bed Rear	
Park Off		Scroll (up, down, and side-ways)	
Park On		Setup Mode	
Pins – Disengage		Speed, Fast	
Pins – Engage		Speed, Slow	
Pins – Boom Hinge		Stop (emergency)	

FIGURE 3-1 continued

Swing		Travel Direction Reverse – Right Crawler	
Swing Left		Travel Speed	
Swing Right		Winch, Rigging	
Travel		Winch, Rigging– Haul In Rope	
Travel Cruise		Winch, Rigging – Pay Out Rope	
Travel Direction Forward – Left Crawler		Windshield Wiper	
Travel Direction Forward – Right Crawler		Windshield Wiper – Overhead with Washer	
Travel Direction Reverse – Left Crawler		Windshield Wiper – Front with Washer	

FIGURE 3-1 continued

Cylinder	Extend		Pin, Hinge (telescopic beam)			
	Retract			Energize (turn on)		
Cylinder, Counterweight Lifting			Set-Up (remote)			
Cylinder, Telescopic Beam				Speed: Fast Slow		
Engine						
Jack:	Extend		Stop, Emergency			
	Retract			Wheels, Right		
Jack (location):	Left Front		Wheels, Left			
	Left Rear				Wheels, Rotate: Clockwise Counterclockwise	
	Right Front					
	Right Rear					
All						
Pin:	Extend					
	Retract					

M3-2

FIGURE 3-2

Reference Only

THIS PAGE INTENTIONALLY LEFT BLANK

FRONT WINDOW OPERATION

Closing Window

Rotate window handle DOWN to position shown in [Figure 3-3](#), View A.

Opening Window For Ventilation

Rotate window handle UP to position shown in [Figure 3-3](#), View B. Window can be swung open approximately 3 in (76 mm) for ventilation.

Opening Window For Emergency Exit

Pull out both quick-release pins at handle. Remove both knobs at top of window ([Figure 3-3](#), View C). Push window out to allow emergency exit from cab.

OPERATING CONTROLS

General

The purpose of the following instructions is to familiarize qualified operators with the location and function of the operating controls for this crane. This section also contains safety information and a description of operation for each crane function.

Depending on the options your crane is equipped with, some controls identified in this section will not apply.

! WARNING

To prevent death or serious personal injury:

- Read and thoroughly understand instructions in this section, in Section 2, and in Capacity Chart Manual.
- Contact your Manitowoc dealer for assistance if you do not clearly understand any operating procedure.

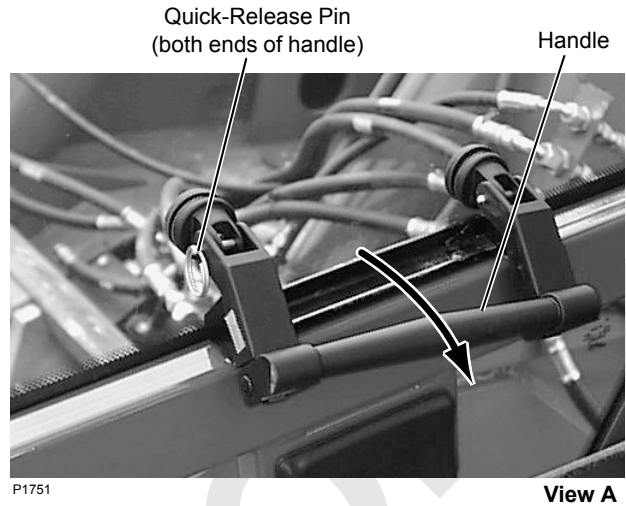

View A

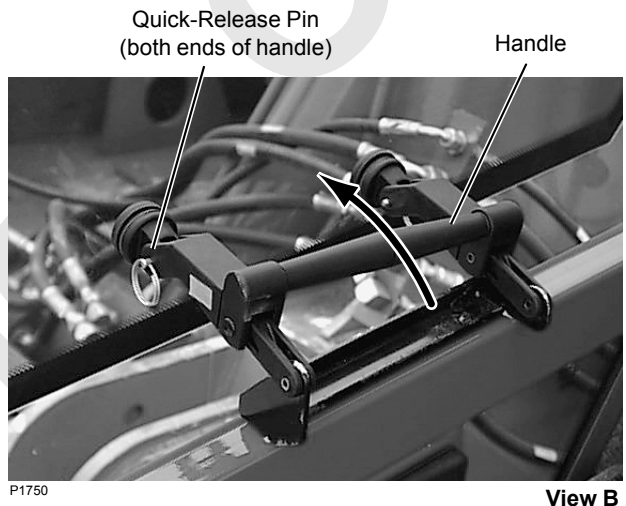

View B

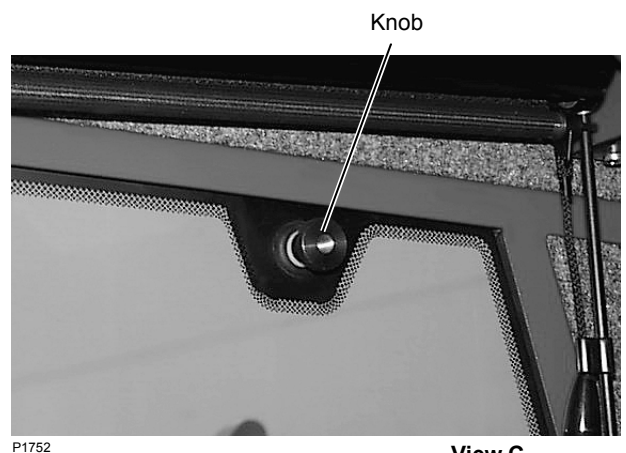

View C
(2 places at top of window)

FIGURE 3-3

CAB DOOR DAMPER ADJUSTMENT

See [Figure 3-4](#) for the following procedure.

The cab door damper prevents the cab door from slamming open or closed. This is especially critical when the cab is tilted at an angle other than horizontal.

Closing Cab Door

To properly close the cab door:

1. Slide cab door to closed position, **but don't latch it**. This releases hydraulic pressure in damper.
2. Open cab door approximately 8.66 in (22 cm).
3. Slide cab door fully closed and latch.

Damper Adjustment

1. Adjust cab tilt to level position.
2. Remove pin.
3. Swing damper with rod end away from cab door.
4. **Pull piston rod out to fully extended position.**
 - a. While pulling on rod, turn it **clockwise** (looking at rod end) approximately four full turns until it stops. This is the **maximum** damper pressure setting.
 - b. While pulling on rod, turn it **counterclockwise** (looking at rod end) approximately four full turns from maximum to **minimum** damper pressure setting. **This is recommended pressure setting.**
5. Reconnect rod end to cab door.

6. It may take several trial and error adjustments to obtain desired damping.

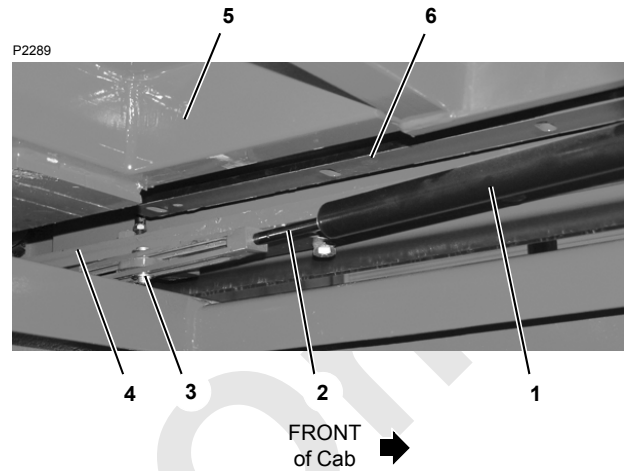

Item	Description
1	Damper
2	Piston Rod
3	Pin with Washers and Cotter Pins
4	Rod End
5	Bottom of Cab
6	Bottom of Sliding Door

FIGURE 3-4

A02019
A09260
A1297

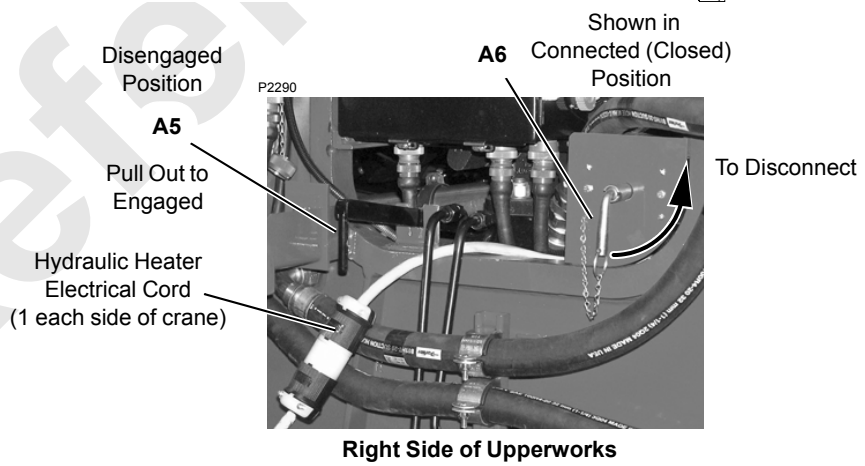
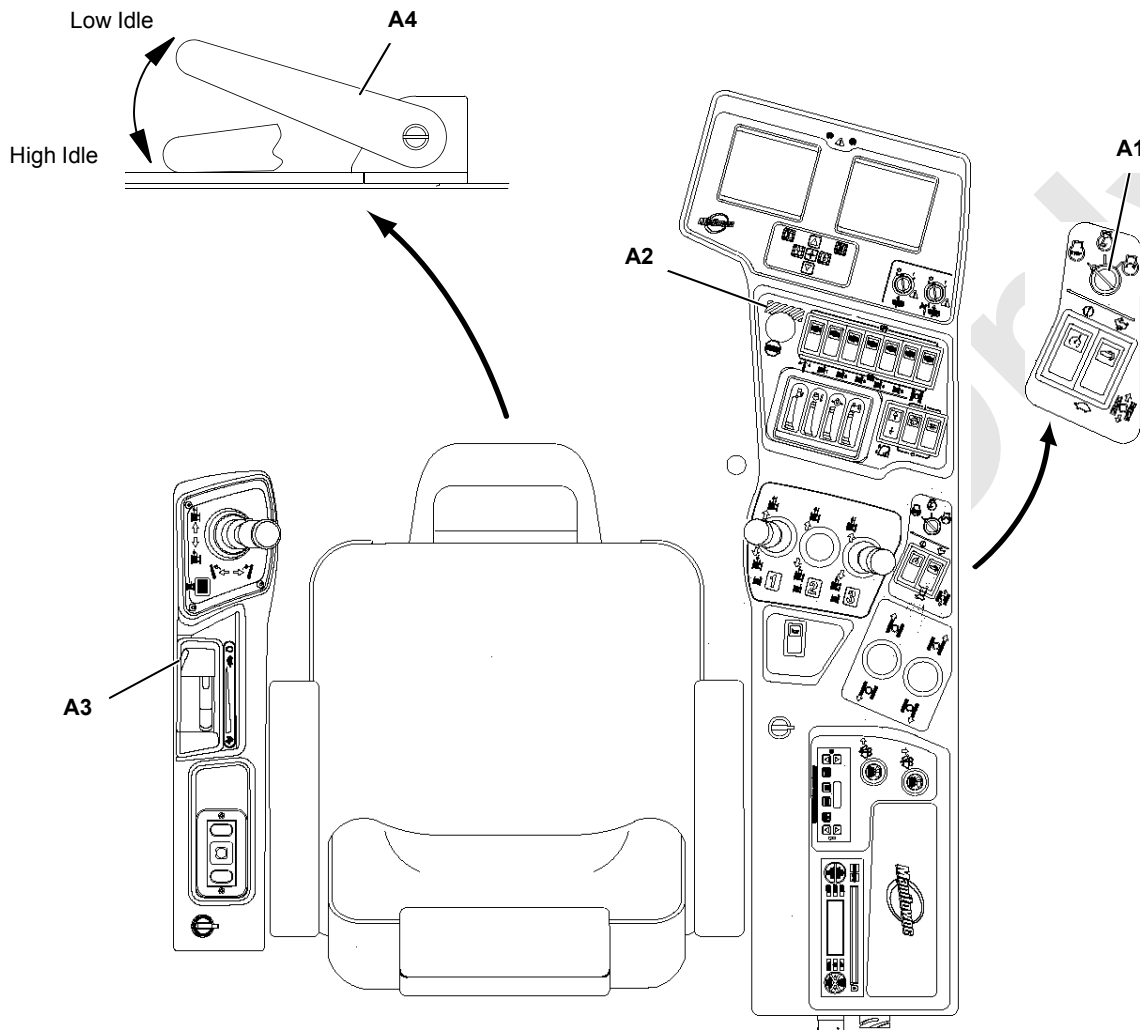

FIGURE 3-5

CONTROLS IDENTIFICATION AND FUNCTION



WARNING

Unauthorized Startup!

Always STOP engine and remove key before leaving the crane unattended. This practice will prevent unauthorized personnel from operating the crane.

A – Engine Controls

See [Figure 3-5](#) for engine controls.

A1. Engine Ignition Switch

Insert key.

Turn CLOCKWISE to RUN position to activate the crane's electric circuits.

Turn fully CLOCKWISE to START engine. **RELEASE to RUN position as soon as engine starts.**

Rotate COUNTERCLOCKWISE to STOP engine and turn off crane's electric system.

NOTE Engine diagnostic faults appear on the engine screen (see Main display in this section) when the ignition is in the run position. The faults must go away when the engine is started. See engine manufacturer's operating instructions manual for engine diagnostic information.

A2. Engine Emergency Stop Switch

Push knob DOWN to STOP engine only in an emergency — for example, if a crane function does not stop when control handle is released to off (center position) or any other uncontrolled motion of a crane function is observed.

Beware — when knob is pushed down, engine stops, brakes apply, and any **functions being operated come to an abrupt stop.**

NOTE The knob must be pulled up before the engine can be restarted.

If the emergency stop switch has been activated, test all disk brakes for proper operation before putting the crane back in service. See Section 2 of Service Manual for procedure.

Use engine ignition switch (A1) to stop engine for normal operating conditions.

A3. Engine Hand Throttle

Pull handle BACK to INCREASE engine speed.

Push handle FORWARD to DECREASE engine speed.

NOTE: The selected engine speed is maintained when the handle is released.

The speed of the crane functions depends on engine speed and on how far the control handles are moved in either direction from off.

Engine speed must be fast enough to provide sufficient power for the work being done. **Engine can stall under load if engine speed is too slow.**

A4. Engine Foot Throttle

PRESS foot throttle to INCREASE engine speed above the hand throttle setting.

RELEASE foot throttle to DECREASE engine speed to idle or to the hand throttle setting.

NOTE: When the engine speed switch on either remote control — setup or MAX-ER® — is in the high speed position, you will not be able to decrease engine speed below approximately 1,500 RPM with the throttle controls in the cab.

A5. Engine Clutch Lever

Pull clutch lever OUT and push DOWN to DISENGAGE the clutch.

Pull clutch lever UP and push IN to ENGAGE the clutch.

A6. Battery Disconnect Switch

Turn handle CLOCKWISE to CONNECT battery circuit.

Turn handle COUNTERCLOCKWISE to DISCONNECT battery circuit for the following reasons:

- When servicing crane's electrical control system
- If desired, to prevent batteries from discharging when the crane is stored for extended periods of time
- If desired, to prevent the crane from being started by unauthorized personnel

CAUTION

Engine Damage!

To avoid possible engine fault codes and undesirable operation, make sure engine ignition switch has been off five minutes before disconnecting batteries.

Do not rely on this switch to protect crane's electronic systems when welding. Disconnect battery cables at batteries before welding.

NOTE: The handle can be removed from the disconnect position to keep unauthorized personnel from connecting the battery and starting the crane.

A1297

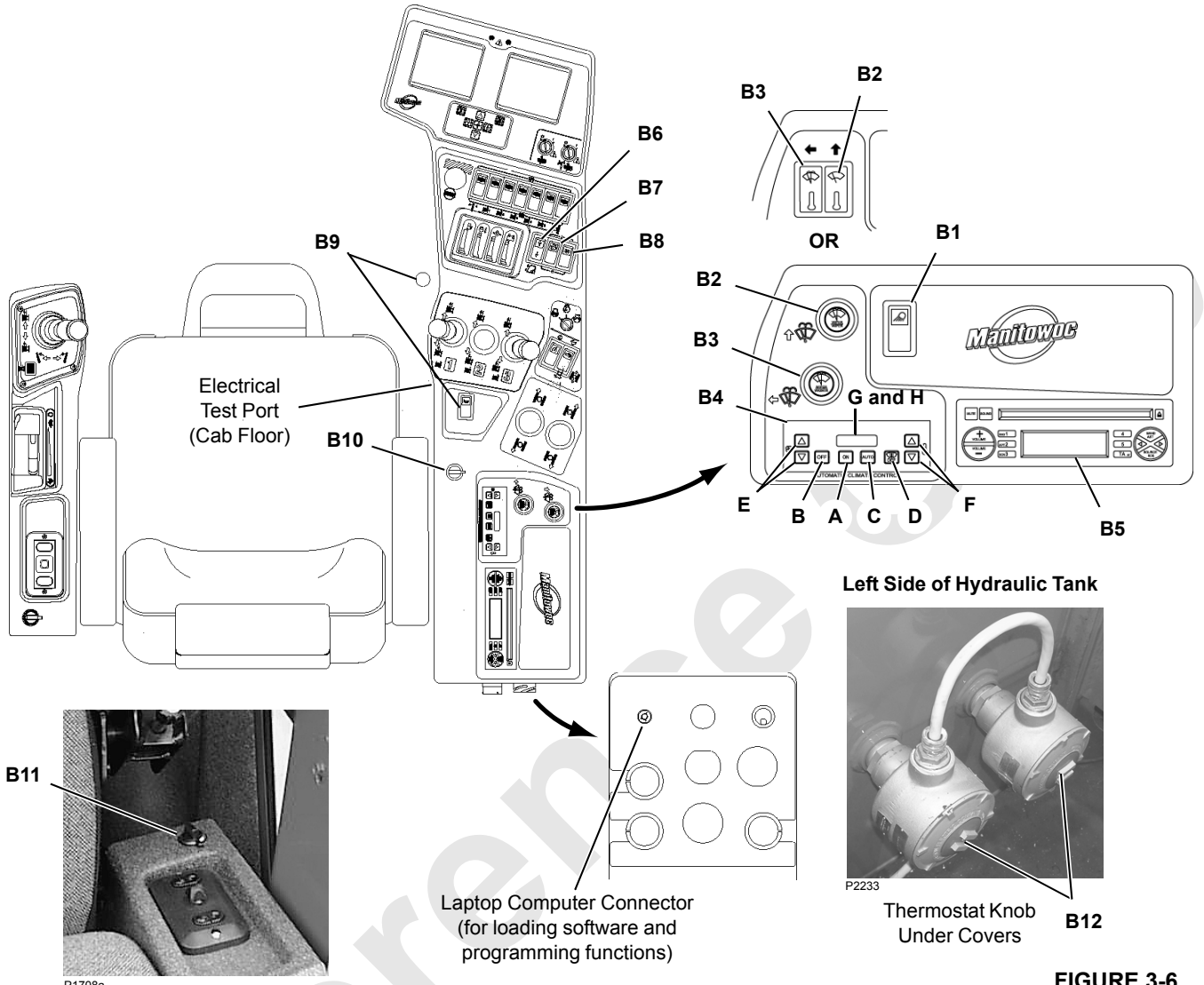

FIGURE 3-6

B – Accessory Controls

See [Figure 3-6](#) for accessory controls.

B1. Crane Work or Drum Lights Switch

This switch controls four optional lights mounted on crane cab, rotating bed, and boom butt.

Press TOP of rocker to TURN ON lights.

Press BOTTOM of rocker to TURN OFF lights.

B2. Overhead Windshield Wiper Switch

B3. Front Windshield Wiper-Washer Switch

PAST PRODUCTION:

- Counterclockwise — OFF.

- Clockwise — INTERMITTENT depending how far knob is turned:
- Clockwise (1st detent) — LOW speed.
- Clockwise (2nd detent) — HIGH speed.
- PRESS front windshield wiper switch to SPRAY washer fluid onto front window.

CURRENT PRODUCTION:

- Toggle fully down — OFF.
- Toggle up — INTERMITTENT depending how far toggle is moved:
- Toggle fully up — HIGH speed.
- PRESS top end of front windshield wiper switch to SPRAY washer fluid onto front window.

NOTE: The windshield washer tank is mounted at rear of cab support. Fill the tank with a quality brand washing solution that **will not freeze during cold weather**.

B4. Climate Control

Provides cab temperature control from 55 to 95°F (13 to 35°C).

- A.** ON - Depress to turn on climate control system. The LED will illuminate and display the current temperature setting.
- B.** OFF - Depress to turn off climate control system.
- C.** AUTO - Depress to places system in fully automatic temperature control mode, to include fan speed. The system will adjust blower fan speed to the lowest setting necessary to maintain the selected cab temperature. A panel indicator light illuminates when this mode is on.
- D.** DEF (defrost) - Depress to energize the A/C system to allow for rapid de-humidification of cab. A panel indicator light illuminates when this mode is on.
- E.** FAN UP/DOWN - Overrides AUTO mode. Depress to increment fan speed up or down in 11 steps. The LED indicates the setting as a percent between HI and LO. The selected fan speed is maintained until changed or the AUTO mode is turned on.
- F.** TEMPERATURE UP/DOWN - Depress to raise or lower the temperature setting. The system maintains the cab temperature as close as possible to the selected temperature.
- G.** LED.
- H.** FAULT CODES - To display fault codes, press ON button three times. Any active fault codes are shown on the LED. Displayed fault codes are:
 - E00 — No Faults
 - E01 — Cab Sensor Shorted
 - E02 — Cab Sensor Open
 - E03 — Evaporator Probe Shorted
 - E04 — Evaporator Probe Open
 - E09 — Water Valve Shorted
 - E10 — Water Valve Open

To change the display temperature from Fahrenheit to Celsius or back, depress TEMPERATURE UP/DOWN buttons simultaneously.

B5. Radio/CD Player (optional)

See manufacturer's instructions.

B6. Cab Tilt Switch

PRESS and hold TOP of rocker to RAISE front of cab.

CENTER rocker to LOCK cab in position.

PRESS and hold BOTTOM of rocker to LOWER front of cab.



WARNING **Moving Cab Hazard!**

Warn personnel to stand clear of operator's cab while tilting.

- Personnel can lose balance and fall.
- Personnel can be crushed between cab and railing.

B7. Panel Lights Switch

Press TOP of rocker to TURN ON panel lights.

Press BOTTOM of rocker to TURN OFF panel lights.

B8. Dome Light Switch

Press TOP of rocker to TURN ON dome light.

Press BOTTOM of rocker to TURN OFF dome light.

B9. Horn Switches

Two horn switches are provided: one on the right console and one on the cab floor. Use either horn **when necessary to warn or signal personnel while the crane is being operated or serviced**.

On right console, PRESS and hold bottom of rocker to turn ON horn.

RELEASE rocker to turn OFF horn.

On cab floor, PRESS and hold down switch with right foot to turn horn ON.

RELEASE foot from switch to turn horn OFF.

B10. Cigarette Lighter

B11. 12 Volt Power Supply Receptacle

Provided for operation and charging a 12 volt cell phone or other appliance.

B12. Machinery Heaters

The hydraulic tank can be equipped with two thermostatically controlled heaters (120 or 240 volt) designed to keep the oil temperature 30°F (17°C) warmer than the ambient temperature.

To aid engine startup in cold weather, plug in the heaters at shutdown; unplug the heaters at startup.

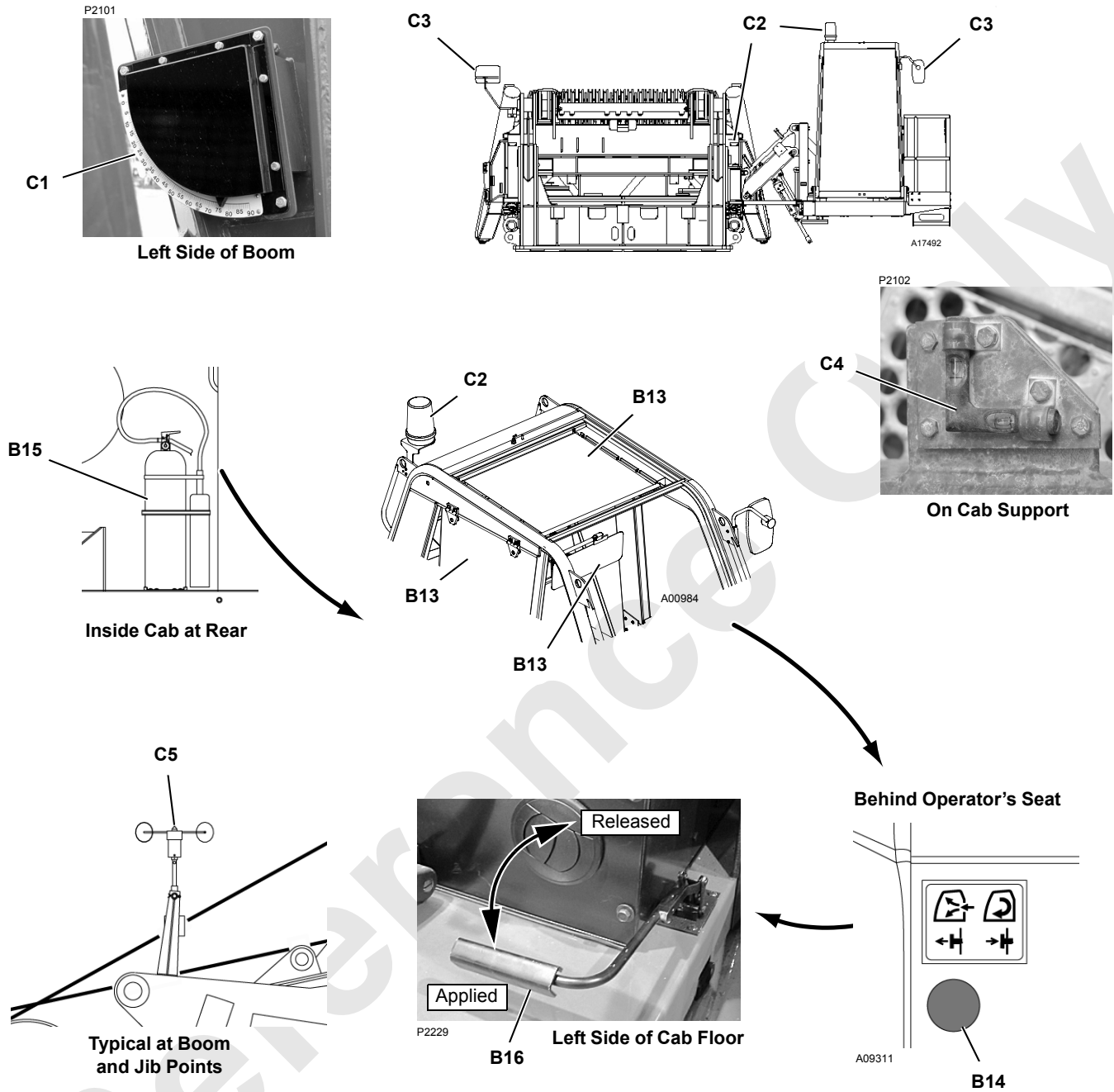

FIGURE 3-7

See [Figure 3-7](#) for the following accessory controls.

B13. Tinted Visor and Shade

A visor is provided for the front window and shades are provided for the roof and side windows. Position the visor and shades as desired to shade sunlight.

B14. Air Ventilation Knob

Pull knob OUT to circulate outside air in the cab.

Push knob IN to close outside air and circulate the existing air in the cab.

B15. Fire Extinguisher

One fire extinguisher is in operator’s cab behind seat. Foreign code requires another fire extinguisher be mounted on the crane.

B16. Cab Door Brake

Manual handle for locking cab door in any position. Push handle down to apply and pull up to release.

C – Indicators

See [Figure 3-7](#) for indicators.

C1. Boom Angle Indicator

Shows the angle of the boom in degrees above horizontal. The boom, luffing jib, and mast angles can be viewed on RCL display or Main display.

See [Figure 3-8](#) for identification of the various boom and luffing jib angles.

C2. RCL Alarm (optional)

The amber beacon rotates and the alarm sounds whenever the crane’s capacity is near an overload condition (when RCL system is ON).

C3. Rear View Mirrors

Adjustable rear view mirrors on operator’s cab and right side of rotating bed allow the operator to view rear of the crane. Mirrors can be rotated inward for shipping.

C4. Bubble Level

On past production cranes with upperworks jacking (S/N 16001032 and older), a bubble level is mounted on the cab support.

On current production cranes (S/N 16001118 and newer), a bubble level is mounted on the front of the carbody.

The bubble level indicates crane levelness from front to rear and from side to side as shown in [Figure 3-9](#).

Crane levelness can also be viewed in the Information Screen of the main display.

! WARNING
Overload Hazard!

Use boom angle indicator only as a guide to position boom near angle corresponding to radius for given load.

In all cases, radius must govern capacity. Exceeding radius given in capacity chart can result in tipping or structural damage.

! WARNING
Tipping Hazard!

Unless otherwise specified on capacity chart, all crane operations must be performed with the crane **level** to within one percent of grade in all directions – 1 ft in 100 ft (0,3 m in 30 m); otherwise, crane could tip.

A1298

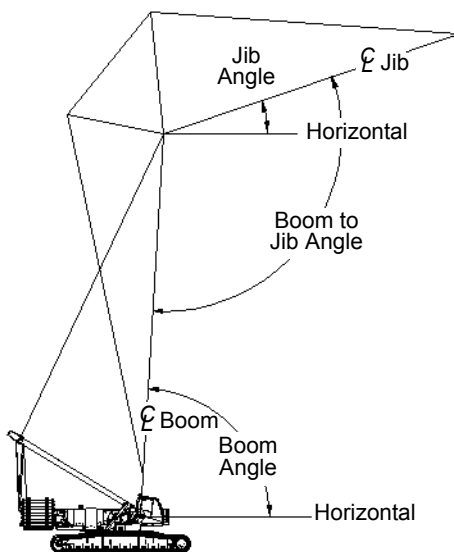

FIGURE 3-8

Centered bubble indicates level. One half of bubble off center indicates approximately one percent of grade out of level.

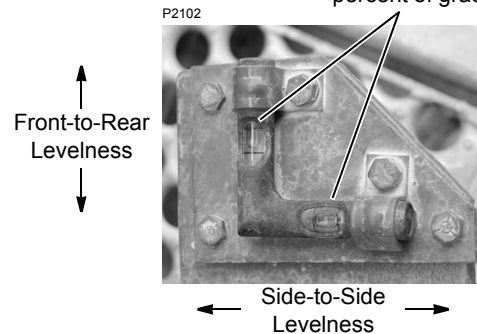

FIGURE 3-9

C5. Wind Speed Transmitter

Wind speed at the boom and jib points appears in the wind speed screen (see Main display later in this section).

A1297

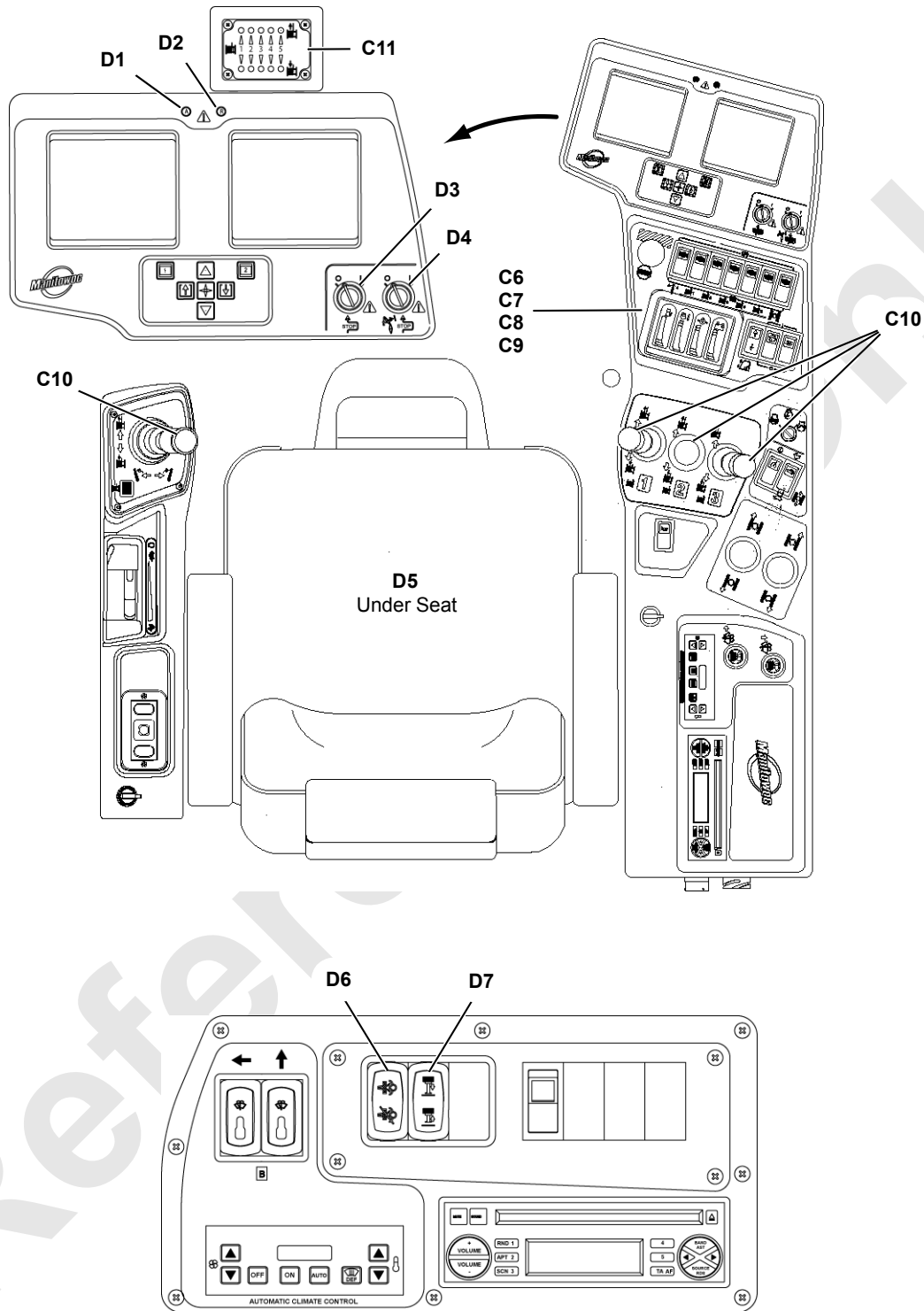

FIGURE 3-10

See [Figure 3-10](#) for the following indicators.

C6. Fuel Level

Indicates amount of fuel remaining in fuel tank.

C7. Engine Coolant Temperature

See engine manual for operating specifications.

C8. Engine Oil Pressure

See engine manual for operating specifications.

C9. Battery Voltage

Indicates condition of battery charging system.

C10. Drum Rotation Indicators

Pin-type actuators located under all drum handle covers. They move UP and DOWN to signal the operator, by feel, that the corresponding drum is turning. Indicator movement corresponds to drum speed.

C11. Drum Direction Indicators

Glow green to indicate the direction in which a drum is being operated.

D – Special Controls

See [Figure 3-10](#) for special controls.

D1. RCL Display and Indicator Lights

Displays load lifting information and alerts the operator to overload conditions. See separate Rated Capacity Indicator/Limiter Operation manual for detailed instructions.

D2. Main Display

Displays operating conditions, faults, and diagnostic information. See Main Display topic in this section for detailed instructions.

D3. Limit Bypass Switch



WARNING

When bypassing a limit, carefully follow instructions under Limit Devices topic in this section.

This switch bypasses the limits identified in [Table 3-2](#) or [Table 3-3](#) on current production cranes without luffing jib limit bypass switch (D4).

Insert key. Turn CLOCKWISE and hold to BYPASS (deactivate) reached operating limits. This position allows the functions to be operated beyond the limits.

RELEASE to ACTIVATE operating limits. This position allows the limits to stop the functions in the normal manner.

Remove key to prevent unauthorized operation.

D4. Luffing Jib Limit Bypass Switch

This switch bypasses the limits identified in [Table 3-2](#). This switch is not provided on current production cranes.

Insert Key. Turn CLOCKWISE to BYPASS corresponding limits. This position allows functions to be operated beyond the limits.

Turn COUNTERCLOCKWISE to ACTIVATE corresponding limits. This position allows limits to stop functions in the normal manner. **Key must be in this position for all normal operation. Otherwise, structural damage can occur.**

Remove key to prevent unauthorized operation.

D5. Seat Switch

Prevents crane from being operated until operator is seated.

When operator is not seated, all control handles are inoperable, all brakes are applied, and travel cruise is turned off.

D6. DPF Switch (Tier 4 Equipped)

NOTE: DPF = Diesel particulate filter (only on cranes with Tier 4 engine).

The DPF switch is a three position switch. Top position is momentary. Center and bottom position is maintained.

CENTER position is for NORMAL engine operation. Regeneration of the DPF will occur automatically.

Press TOP of rocker to START stationary regeneration. Release switch back to center position. Cummins ECM will control a DPF regeneration if necessary. It is normal for the DPF High Temperature lamp to illuminate.

Perform a stationary regeneration only if indicated by the DPF icon in the Tier 4 Engine Information Screen (see [page 3-55](#) in this manual for details).

NOTE: A guard over the top of the rocker prevents unintended regeneration.

Press BOTTOM of rocker to INHIBIT active regeneration. The amber LED in the rocker will glow.

Use INHIBIT only for special circumstances where it is desirable to disable active regeneration. Prolonged engine operation with INHIBIT on will cause the DPF to fill with soot. Too much soot could cause the engine to stop. If that occurs it will be necessary to clean the DPF before the engine can be restarted.

See Engine Manufacturer's Manual for additional information.

D7. BRS Jack Switch (Optional)

Refer to the separate Boom Raising System Manual for detailed operating instructions.

Table 3-2 Bypassable Limit Identification

This Table Applies Only to Cranes with Limit Bypass Switch (D3) and Luffing Jib Limit Bypass Switch (D4)			
Limit ⁵		Limit Bypass Switch (D3) (momentary key switch)	Luffing Jib Limit Bypass Switch (D4) ^{1, 2} (maintained key switch)
Boom Up	[55]	Yes or No ³	No
Block-Up (each drum)	[60]	Yes	Yes
Minimum Bail — (each drum)	[57]	Yes	No
Luffing Jib Maximum UP 1	[49]	Yes	Yes
Luffing Jib Maximum UP 2	[73]	No	No
Luffing Jib Maximum Down 1	[50]	4	4
Luffing Jib Maximum Down 2	[67]	No	No
Mast Too Far Forward	[66]	Yes	Yes
Rated Capacity Indicator/Limiter	[54]	Yes	Yes
MAX-ER [®] Mast Stop Limit Switch	[27]	No	No

¹ Use only for rigging.

² Luffing Jib Limit Bypass Switch (D4) is not provided on current production cranes.

³ The boom up limit cannot be bypassed on current production cranes. To determine if the boom up limit can be bypassed on your crane, perform the test given on [page 3-28](#) in this section.

⁴ When you reach luffing jib maximum down limit, operation does not stop. Fault 50 alarm comes on. You can lower luffing jib an additional 3° to luffing jib maximum down 2 limit.

⁵ Numbers in brackets [] are fault codes. See [Table 3-4](#) starting on [page 3-52](#).

Table 3-3 Bypassable Limit Identification

This Table Applies Only to Cranes without Limit Bypass Switch (D4)

Limit ⁸	Limit Bypass Switch (D3) (momentary key switch)		Limit Bypass Switch (D3) (momentary key switch) Luffing Jib Setup Mode On ¹		External Override Switch ²
	Non-CE ³	CE ³	Non-CE ³	CE ³	CE ³
Boom Up [55]	No	No	No	No	No
Block Up (each drum) [60]	Yes	Yes ⁶	Yes	Yes	No
Minimum Bail (each drum) [57]	Yes	No	No	No	No
Luffing Jib Maximum Up 1 [49]	Yes	No	Yes	Yes	No
Luffing Jib Maximum Up 2 [73]	Yes ⁴	No	Yes ⁴	Yes ⁴	No
Luffing Jib Maximum Down 1 [50]	Yes	No	Yes	Yes	No
Luffing Jib Maximum Down 2 [67]	Yes ⁵	No	Yes ⁵	No	No
Mast Too Far Forward [66]	Yes	Yes	No	No	No
Rated Capacity Indicator/Limiter [54]	Yes	Yes ⁶	Yes	Yes ⁶	Yes ⁷
MAX-ER [®] Mast Stop Limit Switch [27]	No	No	No	No	No

¹ Use only for rigging. See procedure described on [page 3-23](#) for Turning on Luffing Jib Setup Mode.

² See Rated Capacity Indicator/Limiter Operation Manual.

³ CE = Cranes that comply with 2010 European requirements (see NOTE below).

⁴ Only when boom is below 50°

⁵ When this limit is contacted, operation will stop and you will not be able to continue lowering luffing jib. See Luffing Jib Max Down 2 on [page 3-29](#) for detailed instructions.

⁶ Only if boom or luffing jib is below allowable angle given in Capacity Chart (while raising or lowering boom and luffing jib from or to ground level).

⁷ The speed of the crane functions is limited to 15% of their maximum speed for movements that increase load.

⁸ Numbers in brackets [] are fault codes. See [Table 3-4](#) starting on [page 3-52](#).

NOTE: Cranes meeting 2010 European requirements are equipped an RCI/RCL External Override Switch located outside the operator’s cab (see Rated Capacity Indicator/Limiter Operation Manual.)

Reference

THIS PAGE INTENTIONALLY LEFT BLANK

LUFFING JIB SETUP MODE

For cranes with software version FCN 2.654 and newer, the Luffing Jib Setup Mode must be turned on before the limits identified in the center two columns of [Table 3-3](#) can be bypassed.

NOTE: The software version of your crane is shown in the Manitowoc screen of the main display (see [Figure 3-35](#)).

1. Enter the function mode screen in the main display ([Figure 3-11](#)).

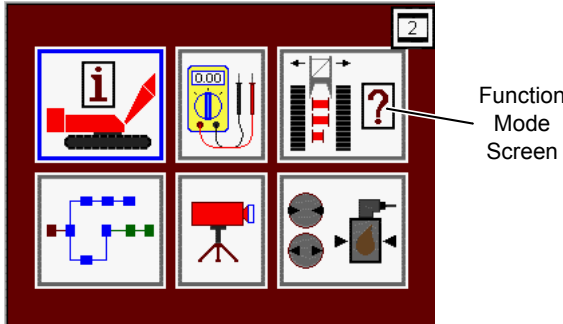

FIGURE 3-11

2. Scroll to and enter the setup screen ([Figure 3-12](#)).

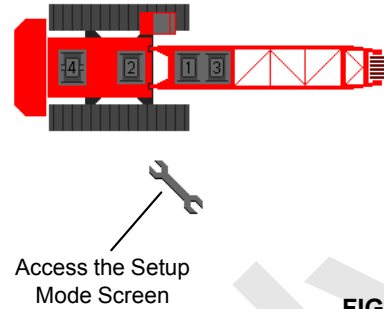

FIGURE 3-12

3. The screen shown in [Figure 3-13](#) will appear.

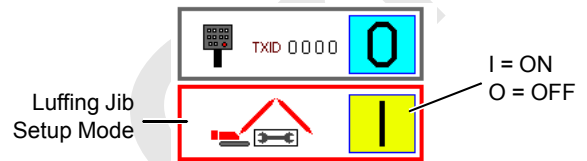

FIGURE 3-13

4. Turn the luffing jib setup mode on (or off when done with luffing jib setup).
5. Rotate limit bypass switch (D3) clockwise and release. The limits will remain bypassed for 10 seconds.
6. Move the desired control handle (luffing hoist, boom hoist, load drum) in the required direction. The limits will remain bypassed for as long as the handle is moved in either direction.
7. The limits will remain bypassed for 10 seconds after the control handle(s) is returned to off.

NOTE: When the luffing jib setup mode is on, the crane setup fault is turned on and the alarm in the cab sounds intermittently.

A02452

DRUM AND HANDLE IDENTIFICATION

Drum No.	Description
0	Rigging Winch (in boom butt)
1	Load Drum (in boom butt)
2	Load Drum
3	Load/Luffing Drum (in boom butt)
4	Boom/Mast Hoist
5	Boom Hoist - with MAX-ER® (in mast butt)

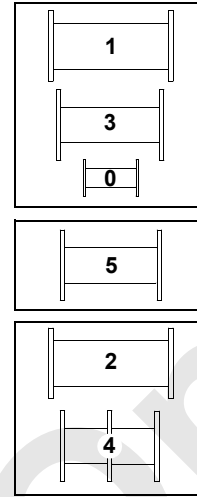

Boom Butt

Mast with MAX-ER® only

Crane

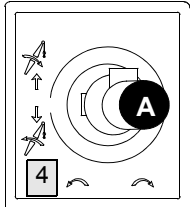

Left Console

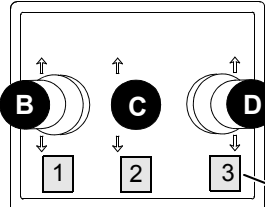

Right Console

Handle Display Lights (4)

Handle Options (Note 1)	HANDLE A Controls Drum	HANDLE B Controls Drum	HANDLE C Controls Drum	HANDLE D Controls Drum
Standard	4 - Boom Hoist	1 - Load Hoist	2 - Load Hoist	3 - Load Hoist
Rigging Winch	0 - Rigging Winch	1 - Load Hoist	2 - Load Hoist	3 - Load Hoist
Luffing Jib (Note 2)	3 - Luffing Hoist	1 - Load Hoist	2 - Load Hoist	4 - Boom Hoist
MAX-ER® Setup	4 - Mast Hoist	1 - Load Hoist	2 - Load Hoist	5 - Boom Hoist
MAX-ER® (Note 3)	5 - Boom Hoist	1 - Load Hoist	2 - Load Hoist	3 - Load Hoist
MAX-ER® w/Luffing Jib (Note 3)	3 - Luffing Hoist	1 - Load Hoist	2 - Load Hoist	5 - Boom Hoist

NOTE 1: Handle display lights show which drums are controlled by corresponding handles.

NOTE 2: Load/Luffing hoist (drum 3) and left travel are both controlled by the same pump. Only one system can be operated at a time.

NOTE 3: In MAX-ER® configuration, boom hoist (drum 5) is operable and mast hoist (drum 4) is inoperable.

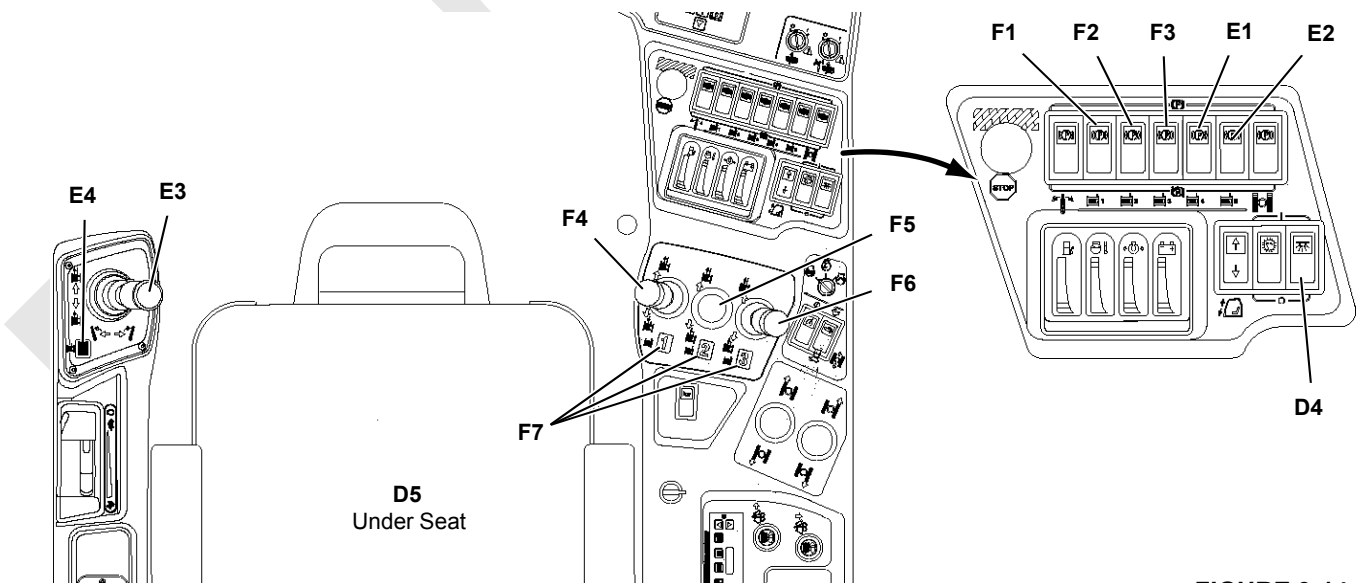

FIGURE 3-14

See [Figure 3-14](#) for drum and handle identification.

E – Boom/Mast Hoist Controls

The boom/mast hoist and swing are controlled by a dual-axis handle that allows both functions to be operated at the same time with one handle.

Boom/mast hoist has a spring-applied, hydraulically-released disc brake on one motor of the drum.

- Drum brake is released automatically when the handle is moved in either direction from off.
- Drum brake is applied automatically when handle is moved to off, engine is stopped (or power is lost for any reason), applicable operating limits are reached, applicable system faults occur, or selected park switch is turned on.

E1. Drum 4 (Boom/Mast Hoist) Park Switch

E2. Drum 5 (Boom Hoist) Park Switch

Press TOP of rocker to TURN ON park switch. With park switch on, boom/mast hoist handle is inoperable, drum brake is applied, and drum pawl is engaged.

Press BOTTOM of rocker to TURN OFF park switch. With park switch off, boom/mast hoist handle is operable, drum brake is applied and released in conjunction with handle movement, and drum pawl is disengaged.

E3. Drum 4 or 5 (Boom/Mast Hoist) Handle

Pull handle BACK to RAISE boom. Drum brake releases and speed increases in relation to handle movement.

Release handle to CENTER to STOP boom. Drum brake spring applies.

Push handle FORWARD to LOWER boom. The drum brake releases and speed increases in relation to handle movement.

NOTE: When the crane is configured with a luffing jib, boom/mast hoist handle D is the last load drum handle on right console. The luffing jib is then controlled with handle A.

E4. Drum Indicator

Drum number appears to indicate that boom/mast hoist is active.

F – Load Drum Controls

Each load drum has a spring-applied, hydraulically-released disc brake on motor at one end of drum.

For normal operation:

- Corresponding drum brake is released automatically when drum handle is moved in either direction from off.
- Corresponding drum brake is applied automatically when drum handle is moved to off.

NOTE: Drum brakes are applied automatically when engine is stopped (or power is lost for any reason), applicable operating limits are reached, applicable system faults occur, or drum park switch is turned on.

F1. Drum 1 Park Switch

F2. Drum 2 Park Switch

F3. Drum 3 Park Switch

Press TOP of rocker to TURN ON corresponding drum park switch. With drum park switch on, drum handle is inoperable, drum brake is applied, and (if equipped) drum pawl is engaged.

Press BOTTOM of rocker to TURN OFF drum park switch. With drum park off, drum handle is operable, drum brake is applied and released in conjunction with handle movement, and (if equipped) drum pawl is disengaged.

F4. Drum 1 Handle

F5. Drum 2 Handle

F6. Drum 3 Handle

The following description is for full-power operation.

Pull handle BACK to HOIST load. Drum brake releases and speed increases in relation to handle movement.

Release handle to CENTER to STOP load. Drum brake spring applies.

Push handle FORWARD to LOWER load. Drum brake releases and speed increases in relation to handle movement.

F7. Drum Indicator

Indicates the number of the drum that the corresponding handle will control. Drum operation can vary depending on crane configuration. See [Figure 3-14](#) for drum and handle identification.

A1297

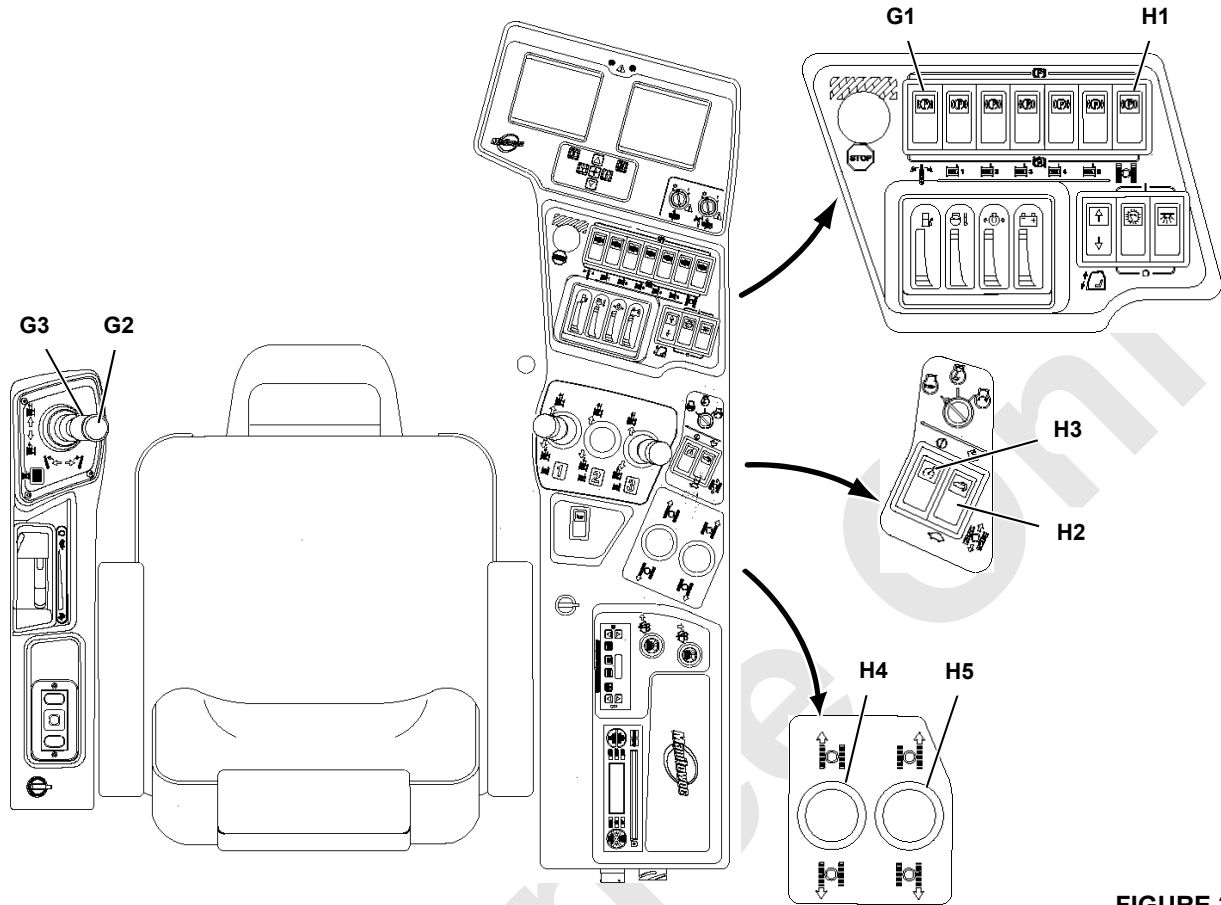

FIGURE 3-14

G – Swing Controls

See [Figure 3-14](#) for swing controls.

NOTE: Current production cranes do not have a swing lock on s/n 16001160 and newer.

Swing drive has a spring-applied, hydraulically-released disc brake and swing lock.

- Brake is released and the lock is disengaged during normal operation.
- Brake is applied automatically if power is lost, when swing holding brake switch is enabled, and when drum park switch is turned on.
- Swing lock is engaged only when drum park switch is turned on.

G1. Swing Park Switch

Press TOP of rocker to TURN ON swing park switch. With park switch on, swing handle is inoperable, swing brake is applied, and swing lock is engaged.

Press BOTTOM of rocker to TURN OFF swing park switch. With park switch off, swing handle is operable, swing brake is released, and swing lock is disengaged.

G2. Swing Handle

- Dual-axis handle allows the boom/mast hoist and swing to be operated at the same time with one handle.
- The swing alarm will beep to warn personnel when the rotating bed is swung.

Move handle to LEFT to SWING LEFT. Swing speed increases in relation to handle movement.

Release handle to CENTER to STOP. Swing speed decreases to off and rotating bed slows to a stop. Move handle in opposite swing direction to stop swing motion faster.

Press swing holding brake switch to hold the stopped rotating bed in position.

Move handle to RIGHT to SWING RIGHT. Swing speed increases in relation to handle movement.

G3. Swing Holding Brake Switch

Use the swing holding brake switch (on side of handle) to hold the rotating bed in position for short periods of time during the operating cycle. The swing brake will apply and the swing handle will be inoperable while the switch is pressed.

PRESS button to APPLY swing holding brake.

RELEASE button to RELEASE swing holding brake.

CAUTION**Swing Drive/Boom Damage!**

Do not apply swing holding brake or turn on swing park switch while swinging; brake will bring rotating bed to an abrupt stop. This action could cause damage to boom from side loading or damage to swing drive from shock loading. Bring rotating bed to smooth stop with swing handle and then apply swing holding brake or turn on swing park switch.

H – Travel Controls

See [Figure 3-14](#) for travel controls.

The crawlers have spring-applied, hydraulically-released disc brakes.

- Both crawler brakes release when either crawler handle is moved in either direction from off.
- Both crawler brakes apply when both crawler handles are moved to off.
- Both crawler brakes apply to hold the crane in position if power is lost for any reason.

H1. Travel Park Switch

Press TOP of rocker to TURN ON travel park switch. With travel park switch on, travel handles are inoperable and brakes are applied.

Press BOTTOM of rocker to TURN OFF travel park switch. With travel park switch off, travel handles are operable and brakes are applied and released in conjunction with handle movement.

H2. Travel Speed Selector

Press TOP of rocker to operate travel motors in HIGH speed. High speed operation provides the maximum available travel speed for traveling long distances.

Press BOTTOM end of rocker to operate travel motors in LOW speed. Low speed operation provides smoother starts and stops and more precise control of the travel motors than high speed.

In low speed, the travel motors operate at approximately 1/3 the speed of high speed.

NOTE: It is okay to change travel speed while traveling:

The travel motors will shift immediately from high to low when low speed is selected.

The travel motors will not shift from low to high when high speed is selected until:

- Engine speed is at high idle
- Hydraulic pressure is low enough to allow the motors to shift from low to high speed

H3. Travel Cruise Selector

The travel cruise selector allows the crawlers to be operated in either direction at a selected speed without the operator's hand on the crawler handles.

Move both crawler handles in either direction from off to select desired speed and direction of travel. Press top of rocker to turn ON travel cruise. Release handles to off. Crawlers continue to travel at selected speed and direction.

Slightly move either crawler handle in the opposite direction or press bottom of rocker to turn OFF travel cruise.

H4. Left Crawler Handle**H5. Right Crawler Handle**

The following directions of travel are with **front of rotating bed and front of carbody facing same direction.**

- Operator's cab is at front of rotating bed.
- Carbody and crawler control valve is at front of carbody. If front of rotating bed and front of carbody face in opposite directions, the crane will travel in the direction opposite handle movement.

Push handle FORWARD to travel FORWARD. Brakes release and speed increases in relation to handle movement.

Release handle to CENTER to STOP traveling. Brakes spring apply.

Pull handle BACK to travel in REVERSE. Brakes release and speed increases in relation to handle movement.

The swing/travel alarm beeps to warn personnel when the crane is traveled.

J – Winch Controls**Rigging Winch Mode**

See Rigging Winch Operation in Section 4 of the Operator Manual.

LIMIT DEVICES

See [Table 3-2](#) and [Table 3-3](#) to determine which limit bypass switch bypasses a given limit.

Boom Up Limit

Automatically stops the boom when it is raised to the following maximum angles:

PAST PRODUCTION

- 83° for boom with or without fixed jib (without luffing jib) when boom up limit **can be bypassed**.
- 87° for boom with luffing jib when boom up limit **can be bypassed**.

CURRENT PRODUCTION

- 84° for boom with or without fixed jib (without luffing jib) when boom up limit **cannot be bypassed**.
- 88° for boom with luffing jib when boom up limit **cannot be bypassed**.

The boom can be lowered after the limit is contacted.



WARNING

Falling Boom/Jib Hazard!

If you bypass the boom up limit for any reason, DO NOT allow physical boom stops to bottom out. Boom butt could be damaged, causing boom and jib to fall over backwards.

Crush Hazard!

Maintain constant communication between operator and assistant during the following steps.

Stay clear of moving parts.

LIMIT BYPASS TEST: Perform the following test to determine if the boom up limit on your crane can be bypassed or not:

1. Lower the boom onto blocking at ground level.
2. Have an assistant push the boom stop rod in to trip the boom up limit switch open.
3. Rotate limit bypass key (D3) to the bypass position and hold.
4. Try to boom up SLOWLY — do not raise the boom any higher than necessary to perform the test:
 - a. If the boom rises, your boom up limit can be bypassed.
 - b. If the boom does not rise, your boom up limit cannot be bypassed.

5. The test is complete: release the limit bypass key and the boom stop rod to the normal operating positions.

Block-Up Limit

Automatically stops the boom or luffing hoist from lowering and the load drums from hoisting if the load contacts a block-up limit switch.

The load on the corresponding drum can be lowered and the boom or luffing jib can be raised after a block-up limit switch is contacted.

The appropriate limit bypass switch must be turned to the bypass position before a load can be hoisted above the limit.



WARNING

Two-Blocking Hazard!

If it is necessary to hoist a load above block-up limit, do so slowly with extreme caution to prevent two-blocking.

Do not hoist load above minimum block clearance given in Range Diagram (see Capacity Chart Manual).

Do not use limit bypass switch to lower boom or luffing jib after block-up limit is contacted; two-blocking could occur, causing load to fall.

Luffing Jib Up Limit

Two luffing jib up limits are provided:

- **JIB MAXIMUM UP 1** (maximum working angle): this programmed limit automatically stops the luffing jib when the boom to jib angle is 169°.

The appropriate limit bypass switch must be turned to the bypass position to allow the jib to be raised an additional 1.5° to JIB MAXIMUM UP 2 limit.

- **JIB MAXIMUM UP 2** (maximum angle): automatically stops the luffing jib when the boom to jib angle is 170.5°.

This limit can be bypassed only when the boom is below 50° (during luffing jib raising and lowering procedure).



WARNING

Falling Boom/Jib Hazard!

Proceed slowly when operating the luffing jib above the JIB MAXIMUM UP 1 limit.

Do not raise luffing jib above JIB MAXIMUM UP 2 limit. Structural damage will occur, possibly causing boom and luffing jib to be pulled over backwards.

The luffing jib can be lowered after either limit is contacted.

NOTE: For cranes meeting 2010 European Requirements and with crane software version FCN 2.654 and newer, the luffing jib cannot be lowered after JIB MAXIMUM UP 2 limit is contacted until the limit switch is reset.

When the limit is contacted, operation will stop and the jib up prompt (shown to right) will appear on the main display.



Once the prompt appears, release the control handle to off and press the confirm button (shown to right) to reset the limit switch. The luffing jib can then be lowered.

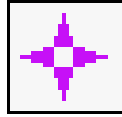

Luffing Jib Down Limit

Two luffing jib down limits are provided:

- **JIB MAXIMUM DOWN 1** (minimum working angle):
For PAST PRODUCTION cranes (prior to crane software version FCN 2.654), this programmed limit does not stop operation. It only activates Fault 50 alarm when the boom to jib angle is 70°.
For CURRENT PRODUCTION cranes (with software version FCN 2.654 and newer) this programmed limit stops operation when the boom to jib angle is 70°.
- **JIB MAXIMUM DOWN 2** (minimum angle): automatically stops the luffing jib when the boom to jib angle is 67°.

NOTE: For cranes with software version FCN 2.654 and newer, the JIB MAXIMUM DOWN 2 limit can be bypassed if the limit switch malfunctions. If the limit switch stops the luffing jib before it reaches the minimum angle given in the Luffing Jib Raising Procedure Chart, proceed as follows:

- Release the control handle to off.
- Turn the bypass switch to the bypass position.
- Lower the luffing jib slowly until it is at the specified minimum angle. Monitor the angle in the working screen of the RCI/RCL display.



WARNING

Falling Boom/Jib Hazard!

Do not lower luffing jib below minimum angle given in Luffing Jib Raising (and lowering) Procedure Chart. Structural damage could result, possibly causing boom and luffing jib to collapse.

The luffing jib can be raised after either limit is contacted.

NOTE: For cranes meeting 2010 European Requirements and with crane software version FCN 2.654 and newer, the luffing jib cannot be raised after JIB MAXIMUM DOWN 2 limit is contacted until the limit switch is reset.

When the limit is contacted, operation will stop and the jib down prompt (shown to right) will appear on the main display.



Once the prompt appears, release the control handle to off and press the confirm button (shown to right) to reset the limit switch. The luffing jib can then be raised.

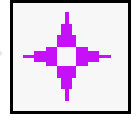

Minimum Bail Limit

Automatically stops the corresponding drum from lowering when there are three wraps of wire rope remaining on the drum.

The load can be raised after the limit is contacted.

The appropriate limit bypass switch must be turned to the bypass position before the load can be lowered below the limit.



WARNING

Falling Load Hazard!

When lowering load below minimum bail limit, do so slowly with extreme caution. Do not lower load to point where less than three full wraps of wire rope are on drum; wire rope could be pulled out of drum allowing load to fall.

MAX-ER[®] Mast Stop Retracted

Applies to software version M002066 and newer. Fault #27 will be active when Node-6 is not configured correctly for crane operation even when MAX-ER[®] is not attached. Shorting plug must be connected to W66P8 whenever mast stop cylinder is not present. Shorting plug must be connected to port W6 of Node-6 whenever cable W66 is not present. See Section 4 for detailed Node-6 configuration.

SEAT CONTROLS

CAUTION**Avoid Damage!**

Disconnect electric cord from rear of left console before you remove seat from operator's cab.

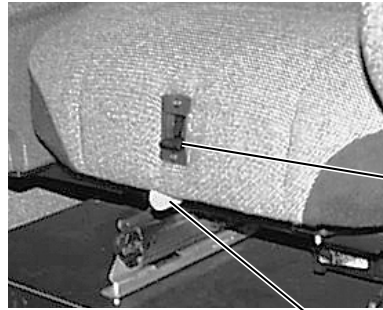

P1743

BACKREST

- Move switch up to release backrest.
- Use body weight to adjust backrest.
- Release switch to lock position of backrest.

**WARNING****Moving Load Hazard!**

Operator, be aware that backrest is spring loaded. If you get out of seat to adjust backrest, it will spring forward.

To prevent backrest from springing forward into control handles and activating crane functions, park all crane functions before getting out of seat.

SEAT FORE-AFT

- Push lever to left to unlock.
- Use body weight to slide seat to desired position.
- Release lever and make sure it is latched to lock seat in position.

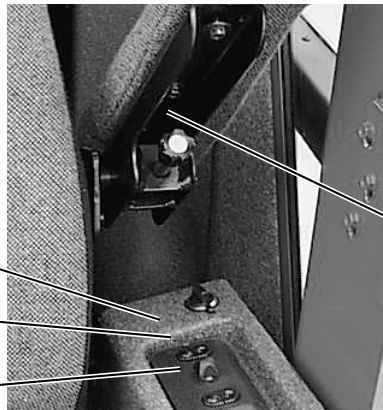

P1708a

SEAT HEIGHT AND POSITION

- Move rear switch up or down to raise or lower seat rear.
- Move center switch to raise/lower seat and move it forward/backward.
- Move front switch up or down to raise or lower seat front.

ARMREST

Turn knob clockwise to raise armrest or counterclockwise to lower armrest.

Left Side of Seat Under Armrest

FIGURE 3-15

PREPARING CRANE FOR OPERATION



WARNING

Read Capacity Charts!

Do not attempt to operate the crane without first reading and understanding capacity charts.

Crane must be rigged and operated according to instructions given in capacity charts and rigging guides.

Unless otherwise specified in capacity charts, all crane operations must be performed with the crane level to within 1% of grade in all directions — 1 ft in 100 ft (0,3 m in 30 m); otherwise, the crane could tip.

Do not operate the crane, to include raising boom from ground level, if wind exceeds limits given in Capacity Charts. Contact your local weather station for wind velocity.

Failing to comply with Capacity Chart requirements can result in tipping or structural failure of boom or luffing jib.

Moving Load Hazard!

Operator must select proper crane capacity chart before operating.

Unexpected drum motion or improper limit responses can result if wrong capacity chart is selected.

Limit bypass switches must be in “activate” position and all limits with which the crane is equipped must be operational before operating the crane. See Service Manual supplied with your crane for adjustment procedures.

Avoid injuring personnel in operating area!

Sound horn to alert personnel that operation is about to begin.

Moving Machinery Hazard!

To avoid injuring personnel or damaging crane and property:

- Do not start engine if warning or out-of-order sign is present at start controls.
- Check that all controls are off so crane and load do not move when engine is started.
- Check that all personnel are clear of the crane before starting engine. **Sound horn to alert personnel.**

CAUTION

Avoid Machinery Damage!

Before operating the crane at start of each shift, perform preventive maintenance checks and lubrication requirements listed in Sections 5 and 6.

Adjust operator's seat as shown in [Figure 3-15](#).

OPERATION

Engine Startup

Read and understand starting instructions in Engine Operation and Maintenance Manual provided with the crane.

1. If used, unplug or turn off engine block heater, engine oil pan heater, hydraulic tank heaters and any other crane heaters.

NOTE: Manitowoc recommends the use of heaters (engine, hydraulic tank, etc.) to aid startup when the ambient temperature will be 32°F (0°C) and below.

CAUTION

Pump Damage!

Do not start engine until hydraulic tank shutoff valve is open; otherwise, pumps could cavitate and be damaged.

2. Open hydraulic tank shutoff valve at rear of hydraulic tank (see [Figure 3-16](#)).
3. Turn ignition switch to RUN position.

NOTE: All indicator lights, operating limit buzzer, and system fault beeper should come on for two to three seconds when ignition switch is in RUN position; if not, replace defective parts.

4. If necessary in cold weather, disengage engine clutch as shown in [Figure 3-17](#). This step will disconnect the pumps from the engine and aid in cold weather startup.

CAUTION

Avoid Engine Clutch Damage!

Observe the following precautions for engine clutch:

- **Decrease engine speed to idle** before engaging or disengaging clutch.
- Do not run engine longer than twenty minutes with clutch disengaged.
- Disengage and engage clutch several times monthly with engine running.

5. Turn ignition switch to START.

CAUTION

Starter Motor Damage!

If engine does not start after 30 seconds of cranking, wait a few minutes so starter motor cools before trying again.

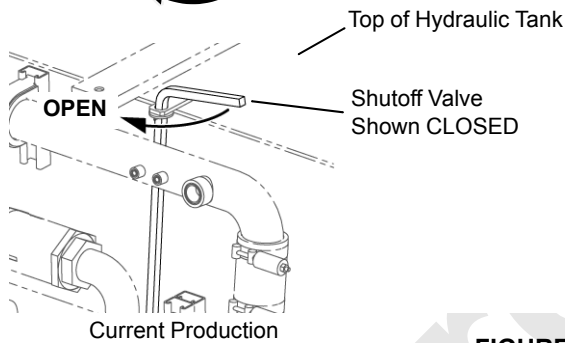
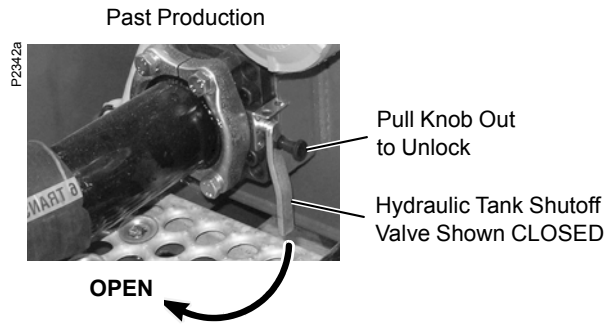
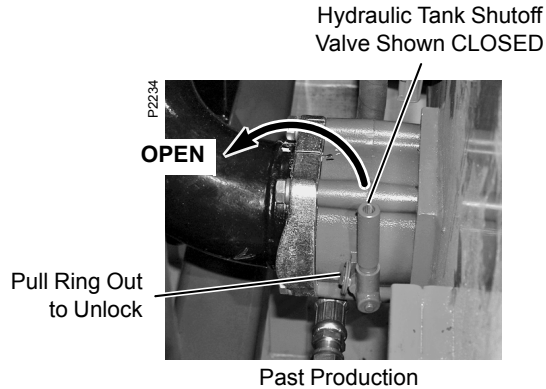

FIGURE 3-16

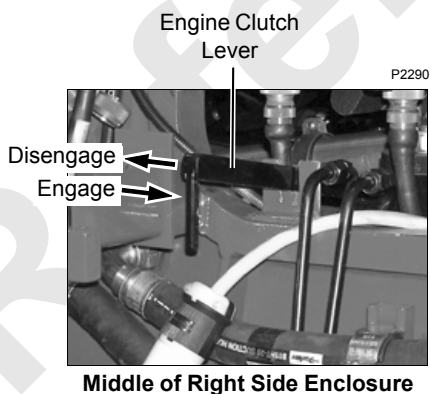

FIGURE 3-17

NOTE: If the engine does not start, check to see if the engine emergency stop switch or the remote control stop switch is depressed. If so, pull it out.

6. Increase engine speed as necessary to keep engine running after it starts.
7. If engine clutch is disengaged, decrease engine speed to low idle and engage engine clutch within 20 minutes after starting engine.

NOTE: The engine clutch may be engaged when the temperature of the hydraulic oil is above 0°F (-18°C).

The hydraulic tank heaters are designed to keep the temperature of the oil in the tank at a minimum of 0°F (-18°C).

8. Run engine at low idle until hydraulic oil temperature is higher than 65°F (18°C). Otherwise, the hydraulic fluid temperature fault will remain on.

NOTE: It is normal for engine and crane faults to appear when the engine is started. The faults should go away as soon as engine oil pressure and hydraulic oil temperature rise to normal (if no other faults exist).

CAUTION

Machinery Damage!

Do not operate the crane when engine and crane faults exist. If faults do not go away soon after engine is started or come on during operation, immediately proceed as follows:

- Determine fault on Main display, Information screen
 - Land loads, if possible, and park all functions
 - Move all control handles to off
 - Stop engine
 - Correct cause of fault
-

9. Select crane configuration and capacity charts on RCL display, Configuration screen. The load drums and hoist drums are inoperable until this step is performed.

CAUTION

Mast Assist Damage!

Prevent damage to mast assist arms and cylinders during cold weather:

- Do not attempt to lower live mast with boom hoist/mast hoist until temperature of hydraulic oil is 60°F (16°C).
- Once oil is at specified temperature, fully extend and retract mast assist cylinders twice to fill cylinders with warm oil.

Cylinders and arms will bend under weight of mast if this precaution is not taken.

CAUTION

Machinery Damage!

Continuous operation with hydraulic oil temperature above 180°F (82°C) can result in damage to hydraulic components. Troubleshoot hydraulic system if oil temperature exceeds 180°F (82°C).

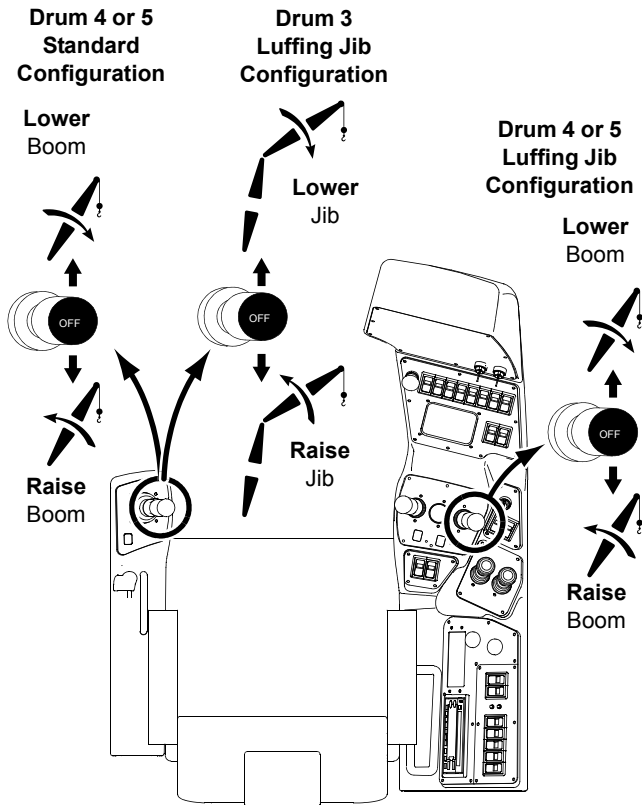

FIGURE 3-18

Boom/Mast Hoist Operation

See [Figure 3-18](#) for boom/mast hoist operation.

In standard configuration the boom/mast hoist handle is on the left console. When the crane is configured with a luffing jib, boom/mast hoist handle is the last load drum handle D on right console.

CAUTION

Avoid Rigging Damage!

Check that boom/mast hoist wire rope is reeved through all sheaves and spooled properly onto drum before raising boom from ground.

- See Boom Rigging Drawing in Section 4 for wire rope and reeving specifications.
- See Wire Rope Installation in Section 4 for instructions on attaching wire rope to boom.

1. Select crane configuration and capacity charts on RCL display, Configuration screen.
2. Turn off Drum 4 or Drum 5 park switch.

CAUTION

Avoid Boom or Jib Damage!

Do not turn on drum park switch while raising or lowering boom; brake will bring boom to an abrupt stop. This action could cause shock load damage to boom and jib. Bring boom to a smooth stop with handle and then turn on drum park switch.

3. Increase engine speed to desired RPM with hand throttle. Depress foot throttle to momentarily increase engine speed when more power is required.
4. See [Figure 3-18](#). Push boom/mast hoist handle FORWARD from off to LOWER boom or pull handle BACK from off to RAISE boom.



WARNING

Avoid Two-Blocking Hazard!

Pay out load lines while lowering boom. Load may contact boom point or jib point sheaves if this step is not taken. Wire rope or other parts could break allowing load to fall.

5. As boom nears desired angle, slowly move handle toward off to decrease speed. Then move handle to off to stop boom and hold it in position and brake will apply.

NOTE: Besides a boom up limit, a physical boom stop cushions boom raising between approximately 78° and the maximum angle. The boom stop also provides a physical stop at 90°.

6. Turn on park switch if boom angle will not be changed.

CAUTION

Avoid Rigging Damage!

When lowering boom to ground:

- If equipped, disconnect fixed jib stop before jib point contacts ground.
- If equipped, remove upper boom point before upper point contacts ground.
- If equipped, disengage luffing jib stop at specified boom to luffing jib angle (see Luffing Jib Rigging Guide).

Luffing Hoist Operation

See [Figure 3-18](#) for Luffing hoist operation.

When the crane is configured with a luffing jib (Drum 3), the multi-function handle on left console controls the luffing jib drum (See [Figure 3-18](#)).



WARNING

Avoid Death or Serious Injury!

Read and understand instructions in Luffing Jib Rigging Guide before attempting to raise or lower luffing jib to or from ground.

Use extreme care when operating luffing hoist and boom hoist at the same time. Maximum or minimum operating radius will be reached quickly when operating both hoists at the same time.

CAUTION

Avoid Rigging Damage!

Check that luffing hoist wire rope is reeved through all sheaves and spooled properly onto Drum 3 before raising boom and jib from ground.

- See Jib Rigging Drawing in Luffing Jib Operator Manual for wire rope and reeving specifications.
- See Wire Rope Installation in Section 4 of this manual for instructions on attaching wire rope to luffing hoist drum.

1. Select luffing jib configuration and capacity charts on RCL display, Configuration screen.
2. Turn off Drum 3 park switch.

CAUTION

Avoid Boom or Luffing Jib Damage!

Do not turn on Drum 3 park switch while raising or lowering luffing jib; brake will bring luffing jib to an abrupt stop. This action could cause shock load damage to boom and jib. Bring luffing jib to smooth stop with control handle and then turn on Drum 3 park switch.

3. Increase engine speed to desired RPM with hand throttle. Depress foot throttle to momentarily increase engine speed when more power is required.
4. See [Figure 3-18](#). Push luffing hoist handle (Drum 3) on right console FORWARD from off to LOWER luffing jib or pull handle BACK from off to RAISE luffing jib.



WARNING

Avoid Two-Blocking Hazard!

Pay out load lines while lowering luffing jib. Load may contact luffing jib point sheaves if this step is not taken. Wire rope or other parts could break allowing load to fall.

5. As luffing jib nears desired angle, slowly move luffing hoist handle toward off to decrease speed. Then move handle to off to stop luffing jib and hold it in position and brake will apply.
6. Turn on Drum 3 park switch if luffing jib angle will not be changed.

CAUTION

Avoid Luffing Jib Damage!

When lowering boom and luffing jib to ground, disengage luffing jib stop at specified boom to luffing jib angle (see Luffing Jib Rigging Guide).

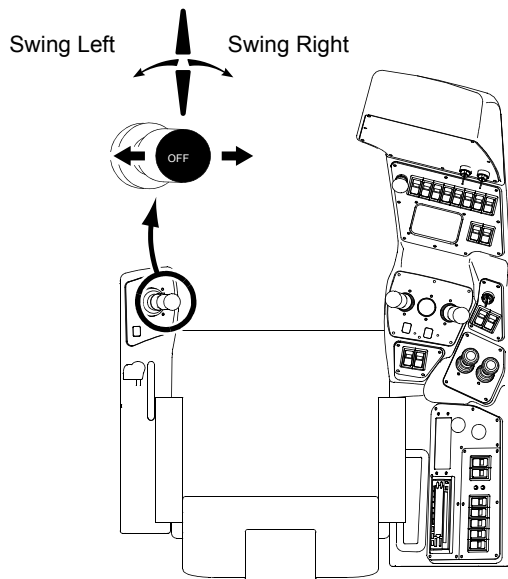

FIGURE 3-19

Swing Operation

See [Figure 3-19](#) for swing operation.

! WARNING Tipping Hazard!

Prevent the crane from tipping; adhere to any swing limitations given in capacity charts.

! DANGER! Moving Crane Hazard!

Counterweights can strike personnel in area of swing path! Warn personnel to stay clear of swing path. Sound horn prior to swinging.

1. Turn off swing park switch.

CAUTION

Avoid Boom/Swing Drive Damage!

Do not apply swing holding brake or turn on swing park switch while swinging; brake will bring rotating bed to an abrupt stop. This action could cause damage to boom and luffing jib from side loading or damage to swing drive from shock loading. Bring rotating bed to a smooth stop with swing handle and then apply swing holding brake or turn on swing park switch.

2. Increase engine speed to desired RPM with hand throttle. Press foot throttle to momentarily increase engine speed when more power is required.
3. See [Figure 3-19](#). Push swing handle to LEFT from off to SWING LEFT or pull handle to RIGHT from off to SWING RIGHT.
4. Start swing motion with a smooth acceleration. Continue handle motion to swing at desired speed.

Swing speed and torque can be adjusted on Main display, Function Mode screen to meet operator comfort.

If equipped with optional swing limits, adjust switches to stop rotating bed at desired position in either direction.

5. Stop swinging by releasing swing handle to off. Swing speed will decrease to off and rotating bed will coast to a stop. If a faster stop is desired, move swing handle past off to opposite swing direction.
6. Once rotating bed stops, apply swing holding brake to hold rotating bed in position for short periods during operating cycle.

To hold rotating bed in position for long periods, turn on swing park switch.

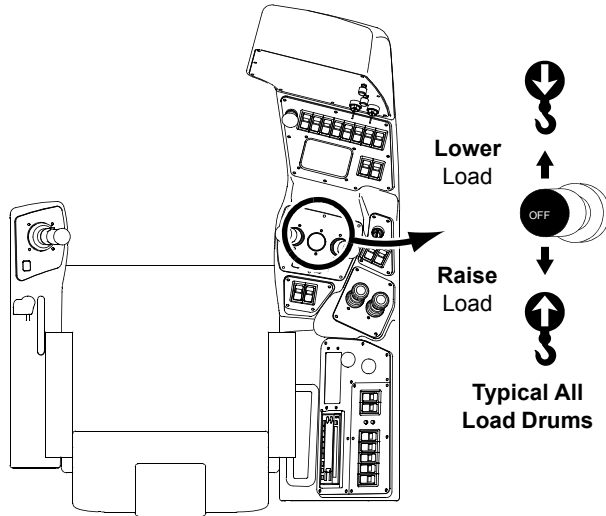

FIGURE 3-20

Load Drum Operation

See [Figure 3-20](#) for load drum operation.

NOTE: See Drum and Lagging Chart in Capacity Chart Manual for drum identification.

! WARNING

Falling Load Hazard!

Prevent load on unused drums from falling. Turn on drum park switch for drums not in use.

1. Select crane configuration and capacity charts on RCL display, Configuration screen.
2. Turn off drum park switch for drum to be operated.

CAUTION

Avoid Boom or Luffing Jib Damage!

Do not turn on drum park switch while raising or lowering load; brake will bring load to an abrupt stop. This action could cause shock load damage to boom, luffing jib, and load line. Bring load to a smooth stop with drum handle and then turn on drum park switch.

3. Increase engine speed to desired RPM with hand throttle. Depress foot throttle to momentarily increase engine speed when more power is required.
4. Pull drum handle (Drum 1, 2, or 3) BACK from off to RAISE load or push handle FORWARD from off to LOWER load.
5. As load nears desired position, slowly move drum handle toward off to slow down load. Then release handle to off to stop load and hold it in position and drum brake will apply.

Travel Operation



WARNING

Tipping Hazard!

Travel surface must be firm and uniformly supporting.

For **traveling with load**, grade must not exceed 1% in any direction.

For **traveling without load**, grade in direction of travel must not exceed 30%; grade from side to side must not exceed 2%, measured at boom hinge pins. For all travel on grades, see Maximum Allowable Travel Specifications Chart in Capacity Chart Manual.

Failing to comply with above specifications can result in tipping.

Moving Crane Hazard!

Know position of rotating bed with relation to front of carbody before traveling. An accident can result if crane travels opposite of intended direction.

Flying Object Hazard!

Excessive dirt build-up at tumbler and front roller ends of crawlers can result in excessive tension in tread connectors. Tread connectors can break if over tensioned, causing treads to fly apart unexpectedly with dangerous force.

CAUTION

Crawler Damage!

Avoid damage to crawler components (treads, rollers, frames)!

Use care to prevent dirt from piling up at tumbler and front roller ends of crawlers when turning on soft surfaces:

- Bring crawlers to a complete stop before changing travel direction.
- Turn a few degrees. Then slowly travel forward or reverse so dirt falls away from crawlers. Continue this procedure until desired turn has been made.
- Avoid sharp turns ([Figure 3-22](#)) if possible.
- Make gradual turns ([Figure 3-23](#)) or counter-rotate ([Figure 3-24](#)) whenever possible so both crawlers are always powered.
- Clean crawlers often.
- Keep crawler treads properly adjusted.

CAUTION

Boom Damage!

Avoid shock loading boom and rigging!

- Perform all travel functions — starting, turning, stopping — slowly and smoothly.

1. Before traveling:
 - a. Plan travel route. It must be free of ground and overhead constructions.
 - b. Check crawlers for proper adjustment.
 - c. Warn personnel to stand clear of travel area. **Do not travel without a signal person.**
2. Position boom at or above boom angle given on capacity chart when **traveling with load**.
3. Travel with boom in-line with crawlers except when swinging is necessary while traveling. Travel with boom facing direction of travel.
4. For **traveling with load**, carry load as close to ground as possible; stabilize load with taglines.

For **traveling without load**, carry load block and weight ball low enough that they cannot swing into boom or jib. If desired, tie off load block at front of rotating bed.
5. Increase engine speed to desired RPM with hand throttle. Depress foot throttle to momentarily increase engine speed when more power is required.
6. Select desired travel speed, low or high.

NOTE: The following directions of travel are with **front of rotating bed and front of carbody facing the same direction**.

- Operator's cab is at front of rotating bed.
- Carbody/crawler control valve is at front of carbody.

If the front of the rotating bed and the front of the carbody face in opposite directions, the crane will travel in the direction opposite of handle movement.

- 7. To TRAVEL STRAIGHT (Figure 3-21), move both crawler handles same amount in desired direction from off.

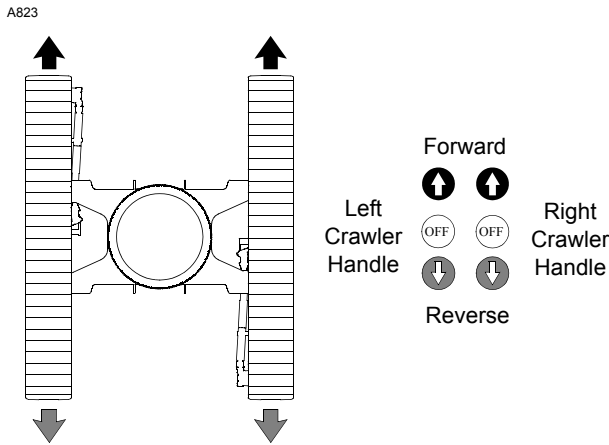

FIGURE 3-21

- 8. To make a SHARP LEFT TURN (Figure 3-22), move right crawler handle to front from off and leave left crawler handle in off; crane will pivot about left crawler.
- 9. To make a SHARP RIGHT TURN, reverse step 8.

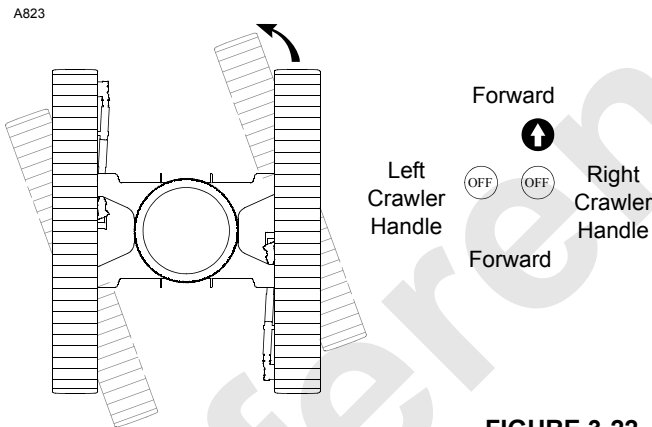

FIGURE 3-22

- 10. To make a GRADUAL LEFT TURN (Figure 3-23), move both crawler handles to front from off, but move right crawler handle farther to front than left crawler handle; right crawler will turn faster than left crawler.

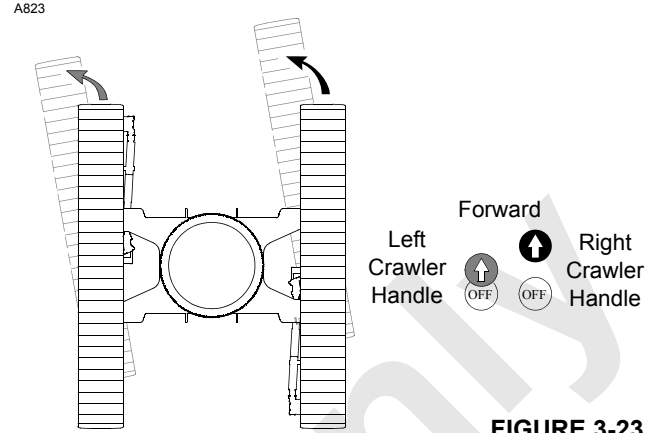

FIGURE 3-23

- 11. To make a GRADUAL RIGHT TURN, reverse step 10.
- 12. To COUNTER-ROTATE LEFT (Figure 3-24), move right crawler handle to front from off and move left crawler handle to rear from off.

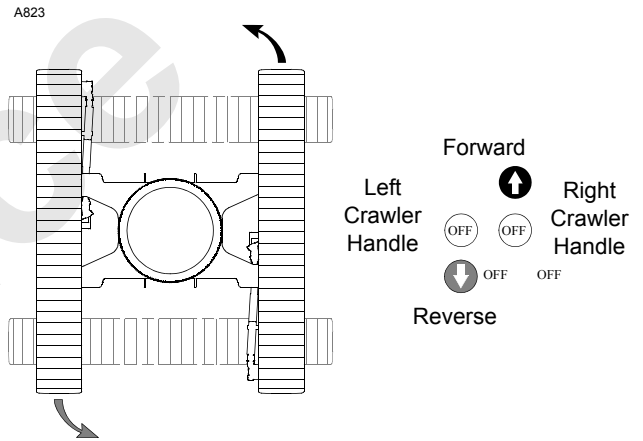

FIGURE 3-24

- 13. To COUNTER-ROTATE RIGHT, reverse step 12.
- 14. Slowly move both crawler handles to off to stop traveling and to hold the crane in position.
- 15. Turn on travel park switch.

STOPPING ENGINE/ LEAVING CRANE UNATTENDED



WARNING

Moving Load/Tipping Crane Hazard!

Operator shall not leave operator's cab until crane, loads, and boom have been secured against movement.

Changing weather conditions including but not limited to: wind, ice or snow accumulation, precipitation, flooding, lightning, etc. should be considered when determining the location and configuration of a crane when it will be left unattended.

1. Travel crane onto a level surface; **do not leave crane unattended on a grade.**
2. Turn on travel park switch.
3. Swing rotating bed to desired position. Then turn on swing park switch.
4. Lower all loads to ground.
5. Turn on drum park switch for each load drum.
6. If possible, lower boom and luffing jib onto blocking at ground level and turn on boom park switch.

If the boom and luffing jib cannot be lowered, as determined by a qualified designated person, they must be securely fastened from movement by wind or other outside forces (see Wind Conditions in Capacity Chart Manual).

NOTE: The designated person shall be familiar with the job site limitations, the crane configuration, and the expected weather conditions.

7. Check that all control handles are off.
8. Decrease engine speed to idle.

Allow engine to idle for three to five minutes so it cools evenly.
9. Stop engine.
10. Remove all keys from cab to **prevent unauthorized operation.**
11. Lock operator's cab windows and door to **prevent unauthorized entry.**

REMOTE CONTROLS



WARNING

Read Instructions!

Avoid death or serious injury to personnel and damage to crane:

- Read Crane Assembly and Disassembly Instructions in Section 4 before operating remote controls.
-

General

The following instructions identify and describe operation of the remote controls used for crane assembly and disassembly. Disregard any control not equipped on your crane.

This crane has two types of remote controls:

- **Electronic** crane setup remote control:
 - Wireless remotes are shown in [Figure 3-25](#)
 - Wired Remote controls are shown in [Figure 3-26](#)

- **Manual** carbody remote control shown in [Figure 3-33](#)

Remote Control Priority

The following instructions apply only to Crane Serial Number 16001128 and newer.

The swing and travel alarm will sound continuously when a function is being operated with any of the following controls:

- Carbody Manual Remote Controls — Priority 1
- Crane Setup Remote Control — Priority 2
- Wheeled MAX-ER[®] Setup Remote Control — Priority 3
- Hanging MAX-ER[®] Setup Remote Control — Priority 4

Additionally on cranes meeting 2010 European Requirements with crane software version FCN 2.654 and newer:

- No two remote controls can be operated at the same time, each has an operating priority as indicated above.
- If you try to operate two remote controls at the same time, the remote control with the higher priority will operate. The other remote control will be disabled (turned off).

Wireless Remote Controls

P1976



Remote Control Stored on Shelf Behind Seat in Cab

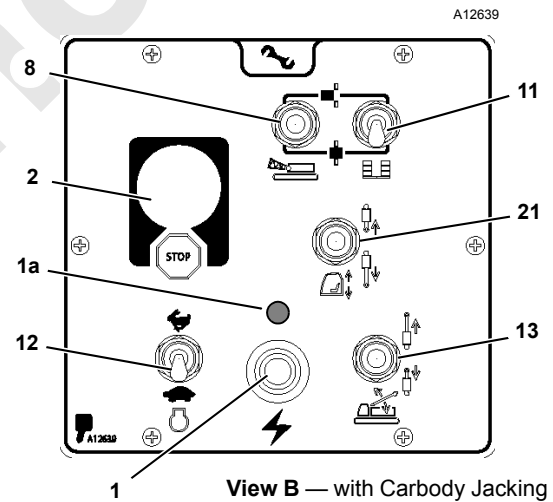
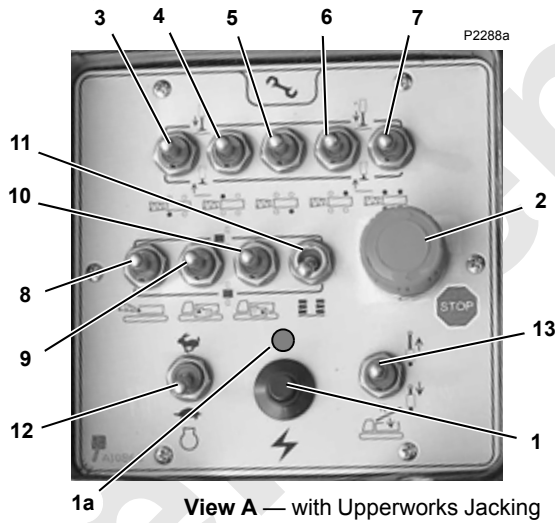

Item numbers in this figure correspond to the component numbers under the topic [Crane Setup Remote Controls Operation](#) on [page 3-45](#)

FIGURE 3-25

Wired Remote Controls

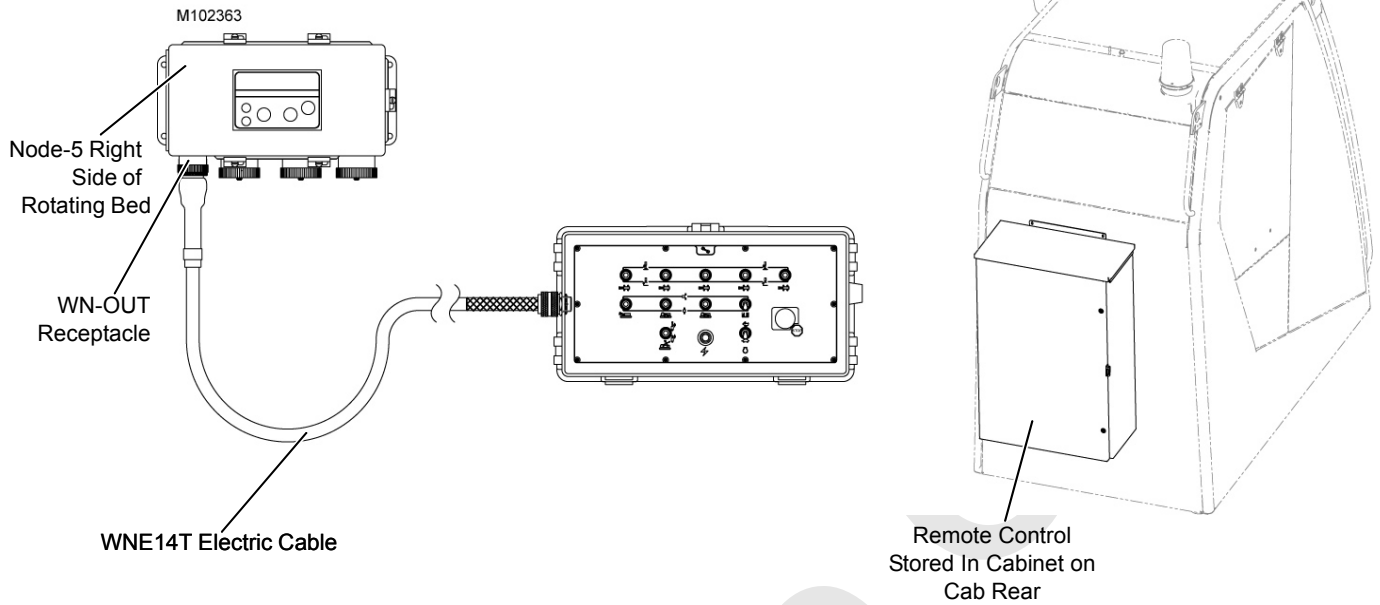

Item numbers in this figure correspond to the component numbers under the topic [Crane Setup Remote Controls Operation](#) on [page 3-45](#)

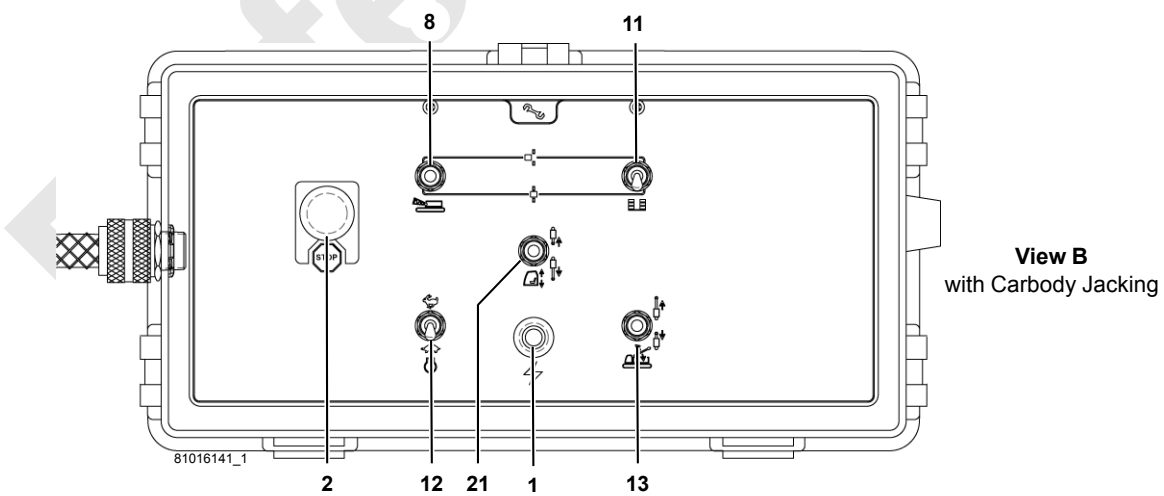
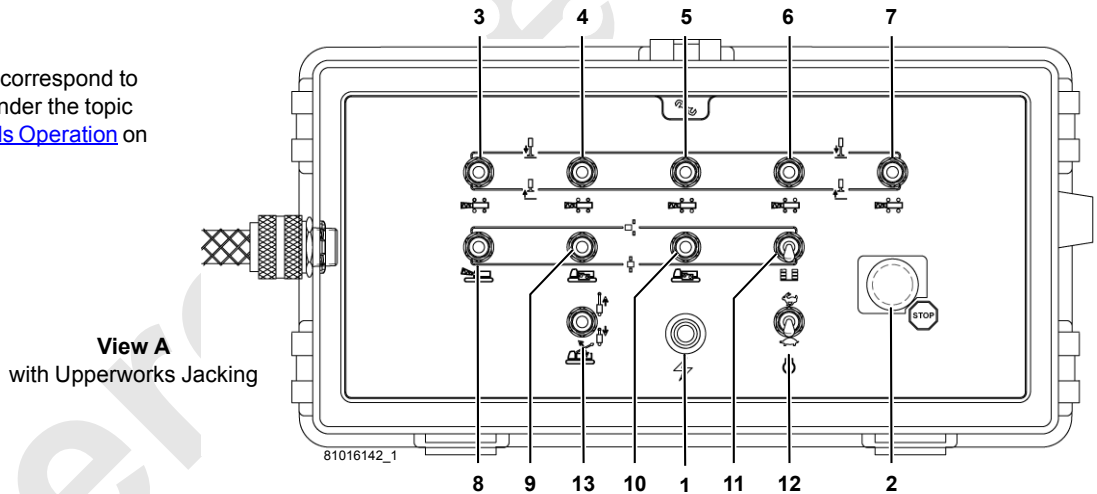

FIGURE 3-26

Crane Setup Remote Control Activation

Wireless Remote Control

The wireless remote control can be operated in any mode.

A slight delay is normal from the time a remote toggle switch is enabled to the time the corresponding function operates.

To turn on the remote control, proceed as follows:

1. Enter the function mode screen in the main display (Figure 3-27).

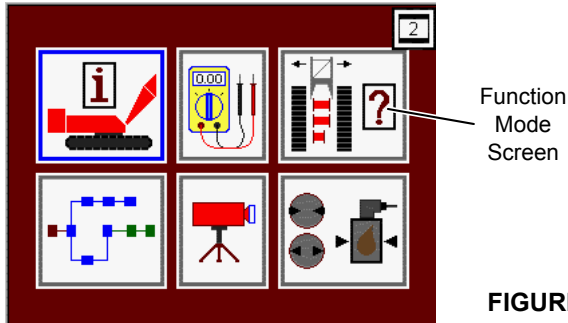

FIGURE 3-27

2. Scroll to and enter the setup screen (Figure 3-28).

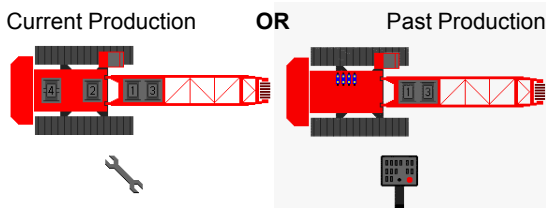

FIGURE 3-28

3. The screen in Figure 3-29 will appear.

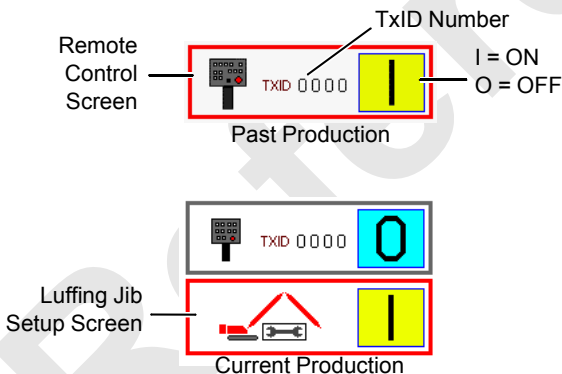

FIGURE 3-29

4. Verify the TXID number on the screen matches the number on top of the remote control. If not, enter the proper number.
5. Hold down the power button on the remote control.

6. Scroll up or down to turn on the remote control.
7. Continue to hold down the power button on the remote control until the remote control ON prompt (shown to right) flashes in the display. This could take 5-10 seconds.



The flashing prompt indicates the remote control is communicating properly.

8. Exit the remote control data box to save the setting.
9. The remote control remains on (remote control ON prompt remains in display) until it is turned off.
10. Reverse the steps to turn off the wireless remote.

Wired Remote Control

To turn on the remote control, proceed as follows:

Set-up remote control can be operated in any mode.

A slight delay is normal from the time a remote toggle switch is enabled to the time a corresponding function operates.

To operate set-up remote control, proceed as follows:

1. Remove remote control from container on rear of cab.
2. Disconnect electric cable (WNE14T) from WN-OUT receptacle on NODE 5 (see Figure 3-26).
3. Connect electric cable from wired remote to WN-OUT receptacle on NODE 5
4. Enter the function mode screen in the main display (Figure 3-30).

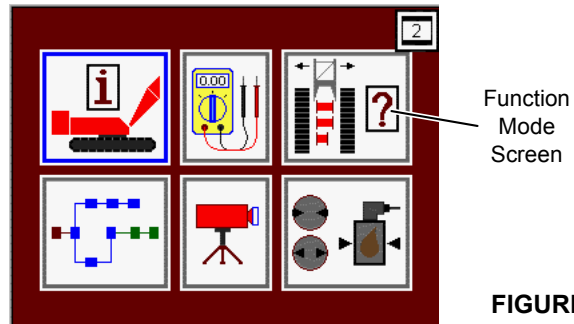

FIGURE 3-30

5. Scroll to and enter the setup screen (Figure 3-31).

Current Production

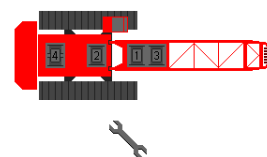

FIGURE 3-31

6. In function mode screen, enter the remote control data box (Figure 3-32).



14-COM-3-23

Remote Control
ON

FIGURE 3-32

7. Scroll up or down to turn on (I) remote control.
8. Remote control ON prompt remains in display until it is turned off.
9. Exit remote control data box to save setting.
10. Hold down power button on remote control.
11. Move selected switch up or down to operate function.
12. Reverses the steps to turn off the wireless remote.

Crane Setup Remote Controls Operation

For wireless remotes, see [Figure 3-25](#) for the following items. For wired remotes, see [Figure 3-26](#) for the following items.

1–Power Switch

DEPRESS button to TURN ON battery power to remote controls.

RELEASE button to TURN OFF battery power to remote controls.

1a–Power Light (Wireless Remotes Only)

The light glows amber when power is on.

2–Stop Switch

DEPRESS knob to STOP the engine and all remote controlled functions in an emergency only — for example: if a function does not stop when the control is released to off or any other uncontrolled motion of a function is observed.

Always use ignition switch in cab to stop engine for normal operating conditions.

Beware — when knob is pushed down, engine stops and any function being operated comes to an abrupt stop.

NOTE: The knob must be pulled UP to RESTART the engine and operate remote controlled functions.

3–Left Front Jacking Toggle Switch

4–Right Front Jacking Toggle Switch

5–Left Rear Jacking Toggle Switch

6–Right Rear Jacking Toggle Switch

7–All Jacking Toggle Switch

WARNING Moving Part Hazard!

To avoid serious crushing injury:

- Keep feet clear of moving jacks.
- Warn all personnel to stay clear of jacks while they are being extended.

Tipping Hazard!

- Keep the crane as level as possible while jacking. Do not allow the crane to get more than 4.5° out of level while jacking to prevent crane from collapsing due to structural failure of jacks.

Move selected toggle UP and hold to EXTEND jacking cylinder.

Release toggle to CENTER to STOP jacking cylinder.

Move selected toggle DOWN and hold to RETRACT jacking cylinder.

Use the ALL toggle to operate all four jacking cylinders at the same time in the selected direction.

CAUTION Machinery Damage!

To avoid damage to jacking cylinders, fully retract them before traveling.

NOTE: On cranes with crane software version FCN 2.654 and newer with upperworks jacking (remote control shown in View A [Figure 3-25](#)):

- The travel and swing alarm will sound while jacking with any switch on the remote control.
- If the crane is out of level approximately 3° to 4-1/2°, jacking will continue. The swing and travel alarm will sound at a lower pitch than normal to alert the operator and fault 4 will appear in the fault screen of the main display (see [Table 3-4](#)).
- If the crane is out of level more than 4-1/2°, jacking will stop. The ALL switch will be inoperable, the swing and travel alarm will sound at a lower pitch than normal to alert the operator, and fault 43 will appear in the fault screen of the main display (see [Table 3-4](#)).
- Level the crane using the individual jacking switches.

8-Boom Pins Switch



WARNING

Falling Load Hazard!

To prevent boom or boom butt from falling off the crane:

- Do not disengage boom hinge pins until boom butt is properly supported on stands at ground level. Boom/boom butt could fall off the crane.
- Read Boom Rigging Guide in Section 4 of this Manual.

Move toggle UP and hold to ENGAGE boom hinge pins.

Release toggle to CENTER to STOP pins.

Move toggle DOWN and hold to DISENGAGE boom hinge pins.

9-Front Rotating Bed Pins Switch

10-Rear Rotating Bed Pins Switch

Move selected toggle UP and hold to ENGAGE rotating bed pins.

Release toggle to CENTER to STOP.

Move selected toggle DOWN and hold to DISENGAGE rotating bed pins.

11-Counterweight Pins Switch

Move toggle DOWN and hold to DISENGAGE counterweight pins. Counterweight pins return to ENGAGED position when toggle is released.

12-Engine Speed Switch

The engine speed switch allows the operator to select high or low engine idle speed from a remote position. Speed of operation (jacks and pins) depends on toggle switch movement and engine speed. To provide adequate speed for some items, engine should be operated at high idle.

Place toggle UP to operate engine at HIGH idle (approximately 1,500 RPM maximum).

Place toggle DOWN to operate engine at LOW idle.

13-Mast Switch

Move toggle UP and hold to RAISE live mast arms with mast cylinders.

Release toggle to CENTER to STOP mast cylinders. Valves on the cylinders lock them in position.

Move toggle DOWN and hold to LOWER live mast arms with mast cylinders.

Read Crane Assembly and Disassembly in Section 4 for live mast raising and lowering instructions.

14-Cab Raise/Lower Switch

Lowers the cab out of working position or raises the cab into working position.

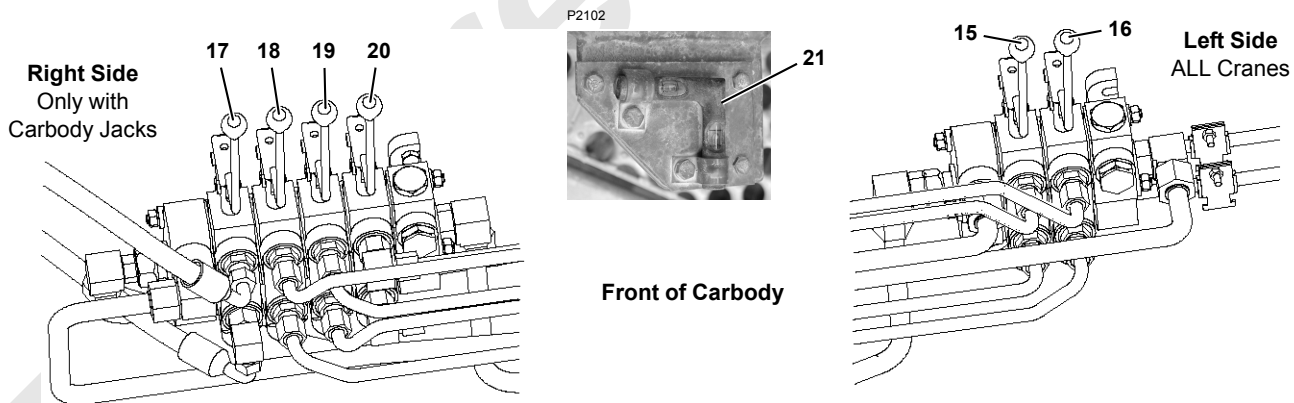

FIGURE 3-33

Carbody Remote Controls Operation

The speed at which the jacks and pins operate depends on control handle movement and engine speed. To provide adequate engine speed, operate engine at mid to high idle.

All control handles are spring returned to off.

See [Figure 3-33](#) for the following items.

15–Right Crawler Pin Handle

16–Left Crawler Pin Handle

Pull selected crawler pin handle DOWN to ENGAGE crawler pins.

Release handle to CENTER when pins are fully engaged.

Push selected crawler pin handle UP to DISENGAGE crawler pins.

NOTE: Carbody jacking is provided as an option to allow the carbody, adapter frame, rotating bed and cab to be transported as one unit.

17–Right Front Carbody Jack Handle

18–Right Rear Carbody Jack Handle

19–Left Rear Carbody Jack Handle

20–Left Front Carbody Jack Handle



WARNING

Moving Part Hazard!

To avoid serious crushing injury:

- Keep feet clear of moving jacks.
- Warn all personnel to stay clear of jacks while they are being extended.

Tippling Hazard!

- Keep the crane as level as possible while jacking. Do not allow the crane to get more than 3° out of level while jacking to prevent crane from collapsing due to structural failure of jacks. Monitor carbody level while jacking.

Push handle TOWARD carbody to LOWER carbody (retract jack).

Release handle to CENTER to stop jack. Valves on the jack lock it in position.

Pull handle AWAY from carbody to RAISE carbody (extend jack).

CAUTION

Machinery Damage!

To avoid damage to carbody jacks, fully retract jacks before traveling.

21–Carbody Level

Indicates crane levelness from front to rear and from side to side while jacking carbody (see item [C4. Bubble Level](#) on [page 3-17](#)).

Wireless Remote Battery Replacement

The wireless remote control is powered by two AA size batteries in the control handle. The battery status is shown on Main display, CAN Bus screen. The wireless icon displays the following:

- 16 and 32 On — 75% and up battery charge
- 32 On, 16 Off — 50% to 75% battery charge
- 32 Off, 16 On — 25% to 50% battery charge
- Both Off — 0% to 25% battery charge

To replace batteries:

1. Remove end cap at bottom of control handle.
2. The seal gasket must remain in place.
3. Remove old batteries.
4. Replace with two AA Lithium type batteries, if possible.

NOTE: Alkaline AA type batteries can be substituted, but battery life is reduced.

DISPLAYS

Display Controls

See [Figure 3-34](#) for the following procedure.

The Menu screens for the RCI and crane are displayed with select buttons. Use the following controls to operate the display screens.

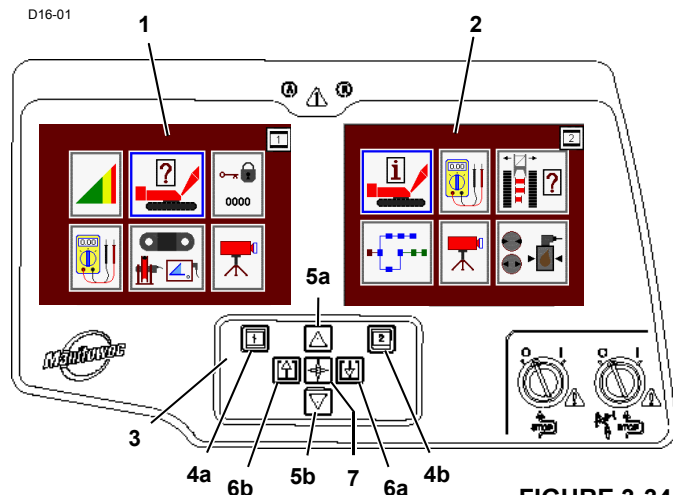

1 – Rated Capacity Indicator (RCI) Display

Rated Capacity Indicator/Limiter (RCI) display is on the left side of front console. (See RCI document for operation.)

2 – Main Display

The main display is on the right side of the front console (these screens are described in this section).

3 – Display Touchpad Controls

Contains all the screen controls required to operate the RCI display and Main display screens.

4 – RCI Select Buttons

- 4a. Select Screen 1 (RCI)
- 4b. Select Screen 2 (Main Display)

5 – Select Buttons

Use the green select touchpad buttons to select screen images, icons or data boxes, and values or icons within data boxes.

- 5a. Select Scroll Up
- 5b. Select Scroll Down

6 – Enter/Exit Buttons

Use the red touchpad buttons to enter (6a) or exit (6b) a screen or to change the screen's operating *level*.

6a. Enter Button

6b. Exit Button

Use Enter button (6a) to enter a screen or go to the next level. Use Exit button (6b) to exit a screen or level.

7 – Confirm Button

Use the purple Confirm touchpad button to start certain test routines from the screen and to confirm data when required.

Display Brightness and Color Contrast

To adjust the display brightness and contrast, proceed as follows:

1. Depress the desired Display button (4a or 4b) and the Confirm button (7) at the same time.
2. Release the Confirm button (7) first and then release the Display Select button (4a or 4b).
3. Press the top Select button (5a) to lighten the display, or press the bottom Select button (5b) to darken the display.
4. Press the Enter button (6a) to increase color intensity, or press the Exit button (6b) to decrease the color intensity.
5. Press the Confirm button (7).

Restore Factory Default Display Settings

This procedure only applies to cranes with program number 16000 FCN 2.039 and newer.

1. Select the screen to adjust by holding the Confirm button (7) and the desired Display Select button (4a or 4b).
2. Release the Confirm button first (7) and then release the Display Select button (4a or 4b).
3. Press both the Select Scroll Up (5a) and Select Scroll Down (5b) buttons at the same time.
4. Press the Confirm button (7)
5. The selected Display (1 or 2) is reset to factory default settings.

Blank Display.

If a display goes blank on cranes with program number 16000 FCN 2.039 and newer, try the following procedure to restore the display. **Do not return a display to Manitowoc until this procedure has been tried.**

1. Press the desired Display button (4a or 4b) and the Confirm button (7) at the same time.
2. Release the Confirm button (7) first and then the Display button (4a or 4b).







3. Press Select buttons (5a and 5b) at the same time to return to the factory default display settings.
4. Press the Confirm button (7).

Main GUI Display Format

The basic components for the Main GUI display format are the Information screen, Diagnostic screens, Function Mode screens, CAN Bus screen, Camera screens, and Pressure Test and Calibration screens. The appearance and function of each screen depends on the screen *level*. Some screen levels show icons and/or data boxes that can be selected to change parameters and/or to enter different screen levels.

Screen Prompts

Screen prompts can appear on a selected screen if a fault condition exists or to prompt or confirm certain operator actions when required by the system. Prompt descriptions and icons are shown below.

- The RCL Display is item 1 and the Main Display is item 2. 
- The yellow alert symbol is displayed if a system fault occurs. See Information screen topic in this section to access faults. 
- The purple confirm prompt appears when the operator must start certain test routines from the screen and to confirm data when required. 
- The wireless remote symbol is displayed when the hand-held wireless remote is enabled. 
- The engine stopped symbol is displayed when engine is stopped. 
- On cranes with software version FCN 2.654 and newer, the data logger icon is displayed for 60 seconds at startup if there is a problem with the data logger (most likely caused by the real time clock). 

A graphic picture of the Manitowoc logo is displayed at crane startup (see [Figure 3-35](#).) The Manitowoc screen displays the following program items:

- Model/ Program Number (example: 16000 FCN 1.012)
- Con Number (example: 009 000 000 008)
- Screen Program Number (example: GUI 2.007)



D16-02

FIGURE 3-35

Menu Screen

See [Figure 3-36](#) for the following procedure.

The Menu screen is the **base** screen for the crane system. All other screens must be entered from this screen. Exiting from any screen will return to the Menu screen.

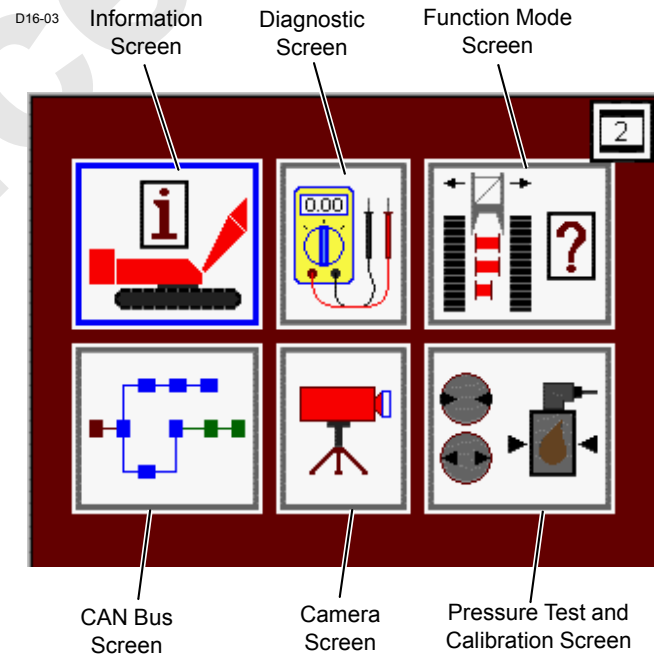

D16-03

FIGURE 3-36

The Menu screen shows six screen icons:

1. Information Screen icon
2. Diagnostic Screen icon
3. Function Mode Screen icon
4. CAN Bus Screen icon
5. Camera Screen icon

6. Pressure Test and Calibration Screen icon

The Menu screen operates on one **level** only.

- Use Select buttons to highlight icon that represents the screen to be entered. Press the Enter button to go to selected screen.
- To return to Menu screen, press Exit button until Menu screen appears.

Information Screen

See [Figure 3-37](#) for the following procedure.

Information screen shows all the general crane information required for viewing during normal operation. The screens contain three data boxes which may be individually tailored to show the information items appropriate for the current crane application.

The Information screen operates on three **levels**:

Level 1— Selected data box highlighted blue. Use Select buttons to highlight the data box to change.

Level 2 — Selected data box highlighted red. Use Select buttons to choose the information item to be shown in the highlighted data box.

Level 3 — Selected data box highlighted green (if applicable). Use Select buttons to alter the information displayed in the highlighted data box.

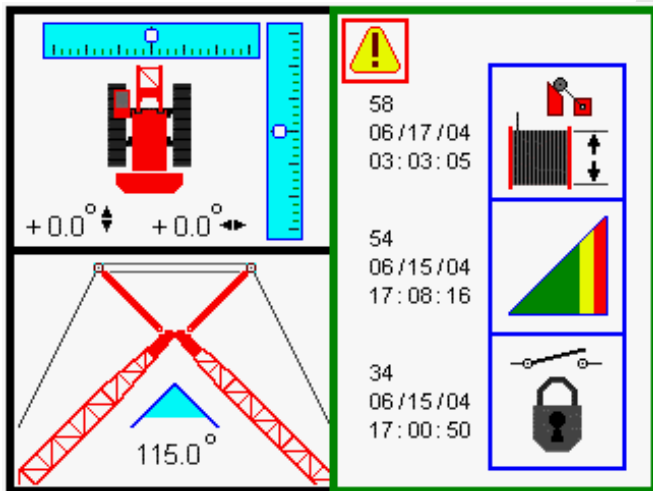
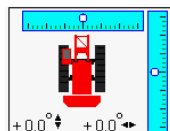

FIGURE 3-37

The crane information items currently available (if equipped) for the two smaller data boxes on the left side of the screen are as follows:

Crane Level

Crane level icon displays the crane level condition forward to rear and side to side. Unless otherwise specified in capacity



charts, all crane operations must be performed with crane level to within one 1% of grade in all directions — 1 ft in 100 ft (0,3 m in 30 m); or crane could tip.

Boom to Luffing Jib Working Angle

Boom to luffing jib icon displays the boom to jib working angle between center line of boom and center line of luffing jib.

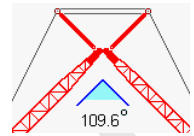

Wind Speed Indicator

Wind speed icon displays the steady wind speed and maximum gust wind speed. The indicator is reset with Confirm button in **level 3**.

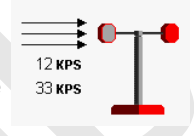

Mast Angle

Mast angle icon displays the mast angle in degrees mast is positioned above transport position.

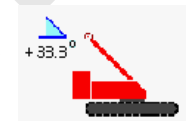

Hydraulic Tank

Hydraulic tank icon displays the tank fluid level in percent and temperature in degrees.

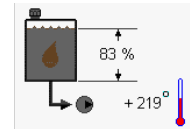

Battery

Battery icon displays the active battery voltage.

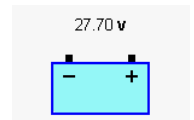

Pump Drive

Pump drive icon displays the oil pressure and temperature of pump drive cooling system.



MAX-ER® Icons

MAX-ER® counterweight lift position and telescopic beam extend icons are not shown. See MAX-ER® Operator Manual for complete MAX-ER® attachment information.

The crane information items currently available (if equipped) for the large data box on the right side of the screen are as follows:

Engine

Engine data box displays the following engine items:

- Engine coolant temperature should be below 204°F (96°C).
- Engine oil pressure should be above 15 psi (1.03 bar).
- Engine speed in RPM, 1050 RPM low idle 1,800 RPM high idle

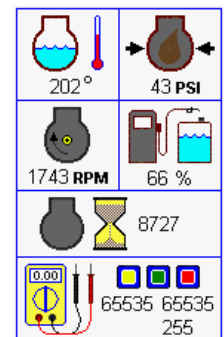

- Fuel level in percent of fuel in main tank
- Engine hours displays the total number of hours engine has been run.
- Diagnostic box with engine manufacturer’s fault code/ flash code. See engine Owners Manual for description of fault codes.

MAX-ER® (Optional)

MAX-ER® data box displays the MAX-ER® wheel position icons (not shown). See MAX-ER® Operator Manual for complete MAX-ER® attachment information.

Faults

The fault data box displays the fault icon with the fault number, date, and time of day listed in the order they occurred.

When one or more faults are enabled, an alarm turns on to warn the operator. The yellow alert symbol is displayed on active screen if a fault occurs. You must go to Information screen to identify the fault. When the fault data box is selected, the screen scrolls through the current faults one icon at a time. The fault history goes back in time to review past faults.

Press the Enter button to access **level 2** and use Select buttons to view past fault history. Press the Exit button to exit the fault screen. The alarm turns off when the cause of fault is corrected. Depending on the configuration, not all listed faults are active (see faults in [Table 3-4](#)).

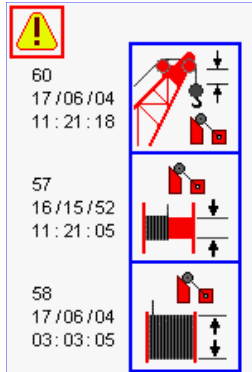

[Table 3-4](#) lists all the faults that can appear in the fault screen. **Some of the fault items shown in [Table 3-4](#) may not be on your crane.**

Faults indicated with an asterisk (*) **will** stop crane operation in the direction of the fault. **Corrective action must be taken before continuing crane operation.** The other faults **will not** stop crane operation. **Correct all faults as soon as possible.**

Tier 4 Engine

This data box displays the following Tier 4 engine icons:

- Engine fault prompt
- DPF regeneration in progress
- DPF regeneration inhibited
- High exhaust temperature
- Diagnostic data with engine light and fault code. Amber warning light: service soon; red warning light: service immediately. See Engine Manufacturer’s Manual for detailed instructions.

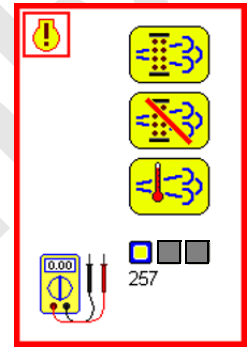









WARNING

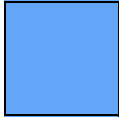

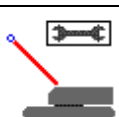
High Exhaust Temperatures!

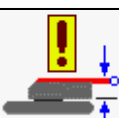



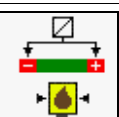
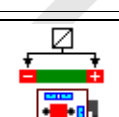
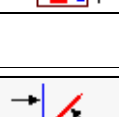

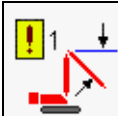
Active DPF Regeneration can occur at low engine idle as well as during crane operation. This may result in high exhaust temperature. Always keep personnel well away from the exhaust to prevent injury and possible death.

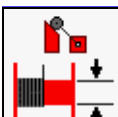
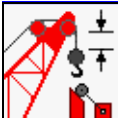
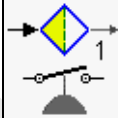
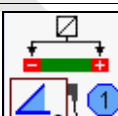
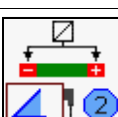
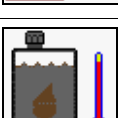
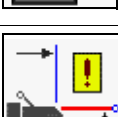
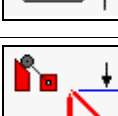

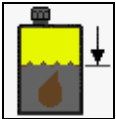

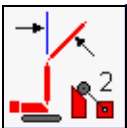
See [page 3-55](#) for details on engine prompts.

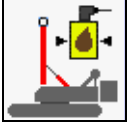
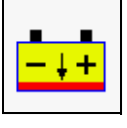
Table 3-4. Faults (*=optional)

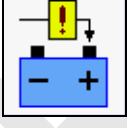
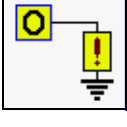
Item	Description
	0-No Fault.
	4-Out of Level (cranes with software version FCN 2.654 and newer) — Indicates that the crane is approximately 3° to 4-1/2° out of level while jacking upperworks with setup remote control.
	6-Setup Mode — Indicates setup mode is on: Liftcrane Mast Capacities Chart selected in configuration screen of RCL or luffing jib setup mode, if applicable, is on.
	10-Engine Fault* — See engine data box on Information screen. See engine Owners Manual for diagnostics fault codes.
	13-Mast 2 Degree Fault* — Stops down movement of live mast when lowering to transport position. Complete mast lowering manually with hand-held wireless remote.
	27-Mast Stop Retracted* — applies to software version M002066 and newer. MAX-ER® lift and boom hoist up will be disabled. This fault cannot be bypassed. This fault will also activate if Node-6 electric cables are not connected properly.
	30-Hydraulic Fan — Indicates a short in the fan circuit or the pressure senders (transducers) are out of range. Fault 41 (Transducer Voltage) or Fault 84 (Digital Output Disable) should light at the same time, indicating the problem.
	34-Function Parked* — Function inoperable because it is parked. Turn indicated park switch off or sit down in operator's seat.
	41-Transducer Voltage — Indicates a pressure transducer is not within the allowable range, high or low.
	43-Out of Level Sensor (cranes with software version FCN 2.654 and newer) — Indicates the crane is approximately 4-1/2° out of level while jacking upperworks with ALL switch on setup remote control. Relevel the crane with individual jacking switches on remote control.
	49-Jib Maximum Up 1* — Program limit stops luffing jib when jib is raised to maximum working angle. Lower luffing jib. Can bypass this limit to raise jib to Maximum Up 2 limit.

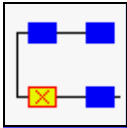
Item	Description
	50-Jib Maximum Down 1* — Program limit activates fault alarm. Operation does not stop. You can lower luffing jib an additional 3° to Luffing jib maximum down 2 limit (67).
	54-Rated Capacity Indicator/Limiter* — Stops all drums. Land load or raise boom/jib.
	55-Boom Up* — Limit switch stops boom in up direction. Move boom in lowering direction.33
	57-Minimum Bail* — Limit switch stops drum (x) from lowering or down direction. Move drum in hoisting or up direction.
	60-Block Up Limit* — Limit switch stops load drum and boom. Lower load or raise boom.
	61-Filter 1 — Filter is dirty or plugged. 62-Filter 2 — Replace element or clean filter.
	63-Boom Angle Sensor — Boom angle sensor is out of normal range (0.15 to 4.85 Volts).
	64-Jib Angle Sensor — Luffing jib angle sensor is out of normal range (0.15 to 4.85 Volts).
	65-Hydraulic Fluid Temperature — Fluid temperature in hydraulic tank is below 65°F (18°C) or above 180°F (82°C).
	66-Mast Too Far Forward* — Live mast is below 156°. Raise live mast. Further lowering is not intended - mast will fall .
	67-Jib Maximum Down 2* — Limit switch stops luffing jib when jib is lowered to minimum angle. Raise luffing jib.

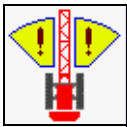
Item	Description
	69-Hydraulic Reservoir Level— Hydraulic oil at caution low level indicated on tank gauge. Fill tank.
	70-Engine Coolant Temperature — Engine coolant temperature above 205°F (96°C).
	71-Engine Oil Pressure — Oil pressure below 7.25 psi (0.5 bar).
	73-Jib Maximum Up 2* — Limit switch stops luffing jib when jib is raised to maximum angle. Lower luffing jib. Cannot bypass this limit.
	75-Low Fuel Level — Five percent fuel remaining in tank. Fill tank as soon as possible to prevent engine stoppage.
	77-Mast System — Boom/mast hoist inoperable in both directions. Determine cause of fault and correct.
	78-Battery Low — Battery voltage below 18 volts. Determine cause of fault and correct.
	80-Invalid Configuration*— Make sure selected RCL configuration for load drums is correct.
	81-Wireless System — Wireless load link sensing fault. See wireless link information in separate Rated Capacity Indicator/Limiter manual.
	83-Alternator — Engine alternator is not generating a charge to the battery.
	84-Digital Output Disabled — Digital output signal has a short circuit between computer node and output device. See CAN Bus screen or Diagnostic screen information to identify problem component.

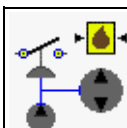
Item	Description
	85-CAN Communication — One or more computer nodes are not communicating correctly. See CAN Bus screen to identify node(s).
	86-Boom Range Limiter* — Up or down range limiter is tripped. Move boom in direction away from limit.
	87-Swing Range Limiter* — Right or left range limiter is tripped. Swing rotating bed in direction away from limit.
	88-Engine Shutdown* — Remote emergency stop shut down switch is pushed. Pull switch up to reset and allow engine to start.
	89-Super Charge Pressure— Pressure switch that monitors hydraulic fluid to main pumps is open.

Diagnostic Screen

Diagnostic screens show a graphic of hydraulic circuit and status of all pumps, motors, valves, and switches that apply to crane function selected.

This view-only screen operates on two **levels**:

Level 1— Image of overall crane shown. Use Select buttons to highlight individual crane functions.

Level 2 — Shows Diagnostic screen for highlighted crane functions.

The yellow alert symbol is displayed if a system fault occurs. Go back to Information screen to identify the fault.

Diagnostic Screen Component Icons

Each Diagnostic screen component icon is identified and described in the following paragraphs.

Control Handle

Displays system control handle command in percent from neutral with +raise and –lower for drums, +right and –left for swing, and +forward and –reverse for travel.



Variable Closed-Loop Pump

Pump command from neutral (0%) to +/-% of full displacement for drums, swing, and travel.

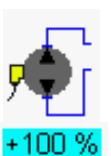

Gear Pump

Accessory pump or system charge pump.



Variable Closed-Loop Motor

Displays motor command with 0% maximum displacement and 100% minimum displacement.



Closed Loop Variable Motor with Remote Pilot

Displays two-speed motor with remote pilot. This motor type is used for shifting motor speeds automatically when selected.

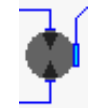

System Pressure Sender

Displays hydraulic pressure (psi/bar).



DIN Electrical Connector

DIN electrical connector changes to yellow when selected item is enabled. The yellow short to ground icon or open circuit icon indicates a circuit fault that must be serviced immediately.

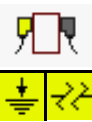

NOTE: Variable outputs may show a yellow icon all the time.

Drum Speed

Displays drum speed in revolutions per minute (RPM). Drum direction is also shown.

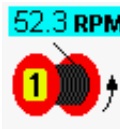

Swing Status

Displays status of swing. Swing right (shown) or swing left arrow is yellow when swing is enabled. Swing speed is shown in revolutions per minute (RPM).



Track Symbol

Shows travel function. Travel (shown right) is yellow when function is operating.

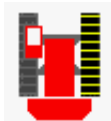

Valve Status

Displays status of a valve.

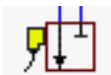

Pilot Valve

Displays status of an external piloted valve.

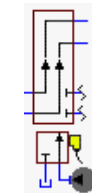

Disc Brake

Displays disc brake status— applied or released (shown).

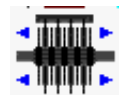

Swing Lock (Past Production)

Displays swing lock status — disengaged (shown) or engaged.

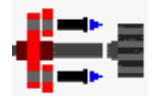

Drum Pawl

Displays pawl status — engaged or disengaged (shown).



Mast Angle

Displays mast angle in degrees mast is positioned above transport position.



Mast Raise Status

Displays command state of mast raise cylinders.



Cab Tilt Status

Displays command state of cab tilt cylinder — cab up/out or down/in (shown).



Rigging Winch Status

Displays command state of rigging winch — haul in or pay out (shown) line.



Counterweight Pin Status

Displays command state of counterweight pin cylinders — extended (shown) or retracted.



Boom Hinge Pin Status

Displays command state of boom hinge pin cylinders — extended (shown) or retracted.



Rotating Bed Pin Status

Displays command state of rotating bed pins — extended or retracted (shown).



Engine Cooling Fan Status

Displays command state of engine cooling fan (shown on).



Crane on Jacks Symbol

Displays image of crane on jacks. Front view icon also shown on Diagnostic screen.



Jack Status

Displays command state of a jack cylinder. Left rear jack extended shown.



Remote Control: Wireless and Wired

Displays remote control status by indicating which switches are closed.

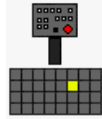

Each control switch corresponds to a number (see [Table 3-5](#)). Switch numbers are 1 through 8 in row one, 9 through 16 in row two, 17 through 24 in row three and 25 through 32 in row four. Not all switch numbers are used. Switch number 14 (Left Front Jack - Extend) is enabled in example shown.

Table 3-5 Wireless Remote Switch Identification

No.	Description	No.	Description
1	Engine Low Speed	16	Right Front Jack - Extend
2	Engine High Speed	17	Left Rear Jack - Retract
7	Boom Pins - In	18	Left Rear Jack - Extend
8	Boom Pins - Out	19	Right Rear Jack - Retract
9	Front Adapter Pins - In	20	Right Rear Jack - Extend
10	Front Adapter Pins - Out	21	All Jacks - Retract
11	Rear Adapter Pins - In	22	All Jacks - Extend
12	Rear Adapter Pins - Out	24	Counterweight Pins - Out
13	Left Front Jack - Retract	25	Mast Lower
14	Left Front Jack - Extend	26	Mast Raise
15	Right Front Jack - Retract	27	Remote Stop

Tier 4 Engine Diagnostic Information

Engine Prompt

Yellow engine alert symbol is displayed if a Tier 4 engine fault occurs. Go to the Tier 4 Information Screen to determine the fault.



DPF Icon

Normally grayed out, displays one of three conditions in color if regeneration inhibit switch

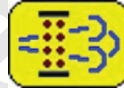

is on (see [page 3-19](#) and Engine Manufacturer's Manual for additional information):

- ON when DPF is starting to fill. Turn off regeneration inhibit switch. No immediate action is required.
- FLASHING when DPF is nearly full. The operator may sense a reduction in power. Turn off regeneration inhibit switch. No immediate action is required.
- FLASHING and red engine light ON. The DPF is full. The operator will notice a significant reduction in engine power. Turn off regeneration inhibit switch and perform a stationary regeneration immediately (see Engine Manufacturer's Manual for procedure).

DPF Regeneration Inhibited Icon



ON when active regeneration has been stopped by pressing the regeneration inhibit switch. Excessive use of regeneration inhibit will result in the need to service or replace the DPF.

High Exhaust System Temperature (HEST) Icon



ON when higher than normal exhaust temperatures exist due to DPF regeneration.



WARNING

High Exhaust Temperatures!

Active DPF Regeneration can occur at low engine idle as well as during crane operation. This may result in high exhaust temperature. Always keep personnel well away from the exhaust to prevent injury and possible death.

Drum Diagnostic Screens

Select drum icon in screen **level 1** as shown [Figure 3-38](#). Press Enter button to go to **level 2**.

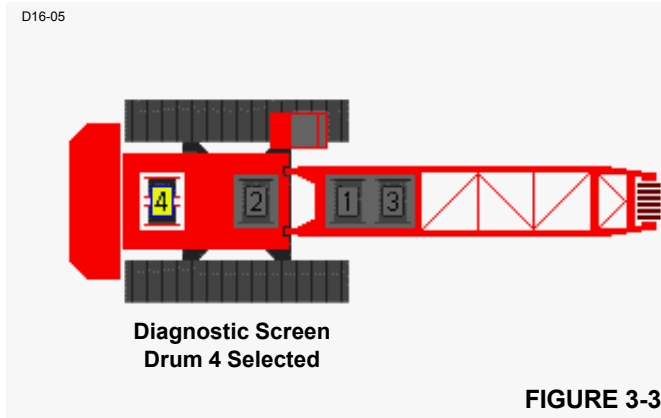

FIGURE 3-38

In the drum example shown in [Figure 3-39](#), drum 4 function is shown hoisting **up**. A single pump is shared with drum 5 and is connected to drum 4 through a diverting valve. A second pump could also power drum 4 shown connected to the left track through upper diverting valve.

NOTE: Mast hoist drum 5 is only selected when the crane is configured with a MAX-ER®.

For load drums 1 or 2, drum 2 pump is dedicated to the drum 1 motor through diverting valve when drum 1 is selected. The opposite is true when drum 2 is selected. Both drums can be operated at the same time but would operate at one half speed.

For load drum 3, the left travel pump is dedicated to operate drum 3 motor through diverting valve when drum 3 is selected. Drum 3 is inoperable when traveling. Drum 3 can be configured as load drum or luffing jib.

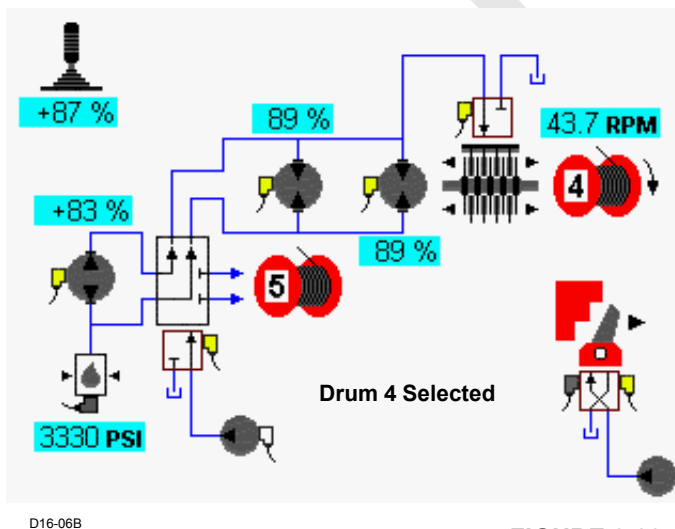

FIGURE 3-39

Swing Diagnostic Screen

Select swing icon in screen **level 1** as shown in [Figure 3-40](#). Press Enter button to go to **level 2**.

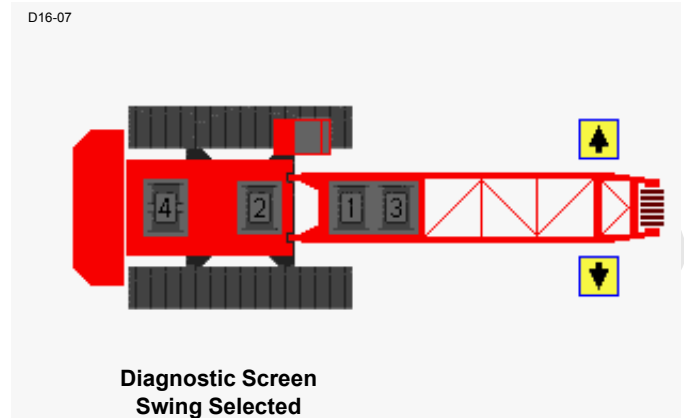

FIGURE 3-40

Swing system icons are displayed in [Figure 3-41](#). The example shows how the swing function might appear when swinging right. Circular arrow symbols near each pressure sender indicate which sender monitors swing right and left pressures.

NOTE: The example in [Figure 3-41](#) is for past production cranes with swing lock. See section one of the service/maintenance manual for current production swing diagnostic screen with swing lock removed.

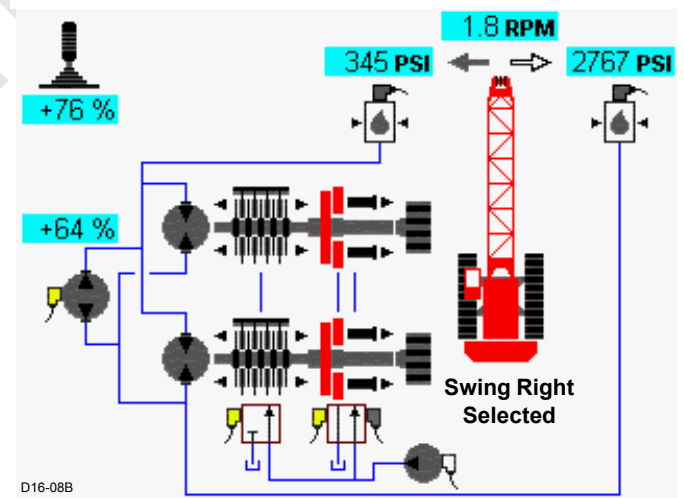
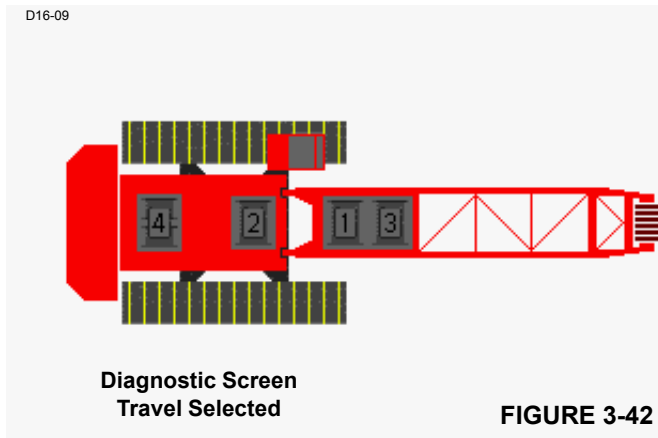

FIGURE 3-41

Travel Diagnostic Screen

Select travel icon in screen **level 1** as shown in [Figure 3-42](#). Press Enter button to go to **level 2**.



In travel system example shown in [Figure 3-43](#), the left travel pump is dedicated to operate drum 3 through diverting valve if drum 3 is selected. The right travel pump is dedicated to operate drum 4 through diverting valve if drum 4 is selected under certain conditions when drum 5 is also configured.

NOTE: When crane travel is enabled, drum 3 is disabled.

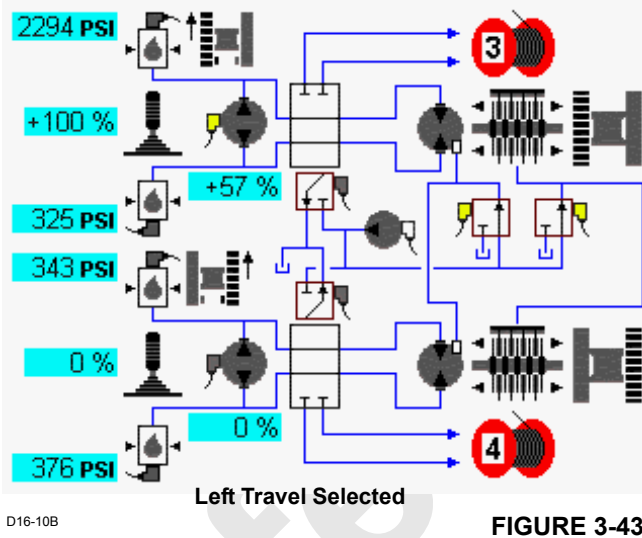

Jacking Accessory Diagnostic Screen

Select crane carbody with jacking icon in screen *level 1* as shown in [Figure 3-44](#). Press Enter button to go to *level 2*

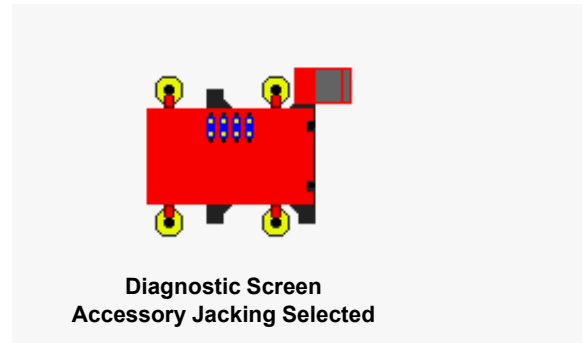

At jacking accessory diagnostic screen component icons are displayed as shown in [Figure 3-45](#). In the following example, all jack switch on wireless remote is selected. The crane on jacks icons indicate crane level status.

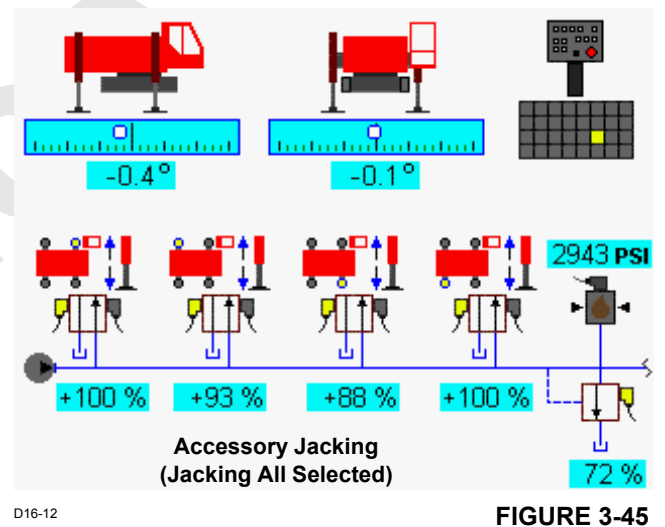

Pins and Fan Accessory Diagnostic Screen

Select crane, pins, and engine fan icon in screen *level 1* as shown in [Figure 3-46](#). Press Enter button to go to *level 2*.

3

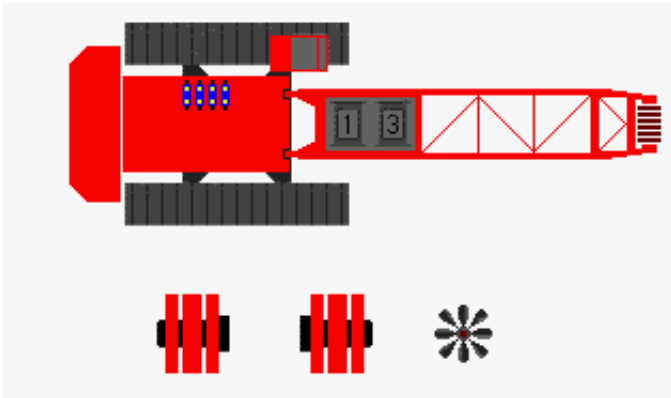

FIGURE 3-46

D16-13

For counterweight pins, boom hinge pins, front/rear rotating bed pins, and engine fan screen see [Figure 3-47](#). In the following example, the left front rotating bed pin on wireless remote is selected. Engine fan status is also shown.

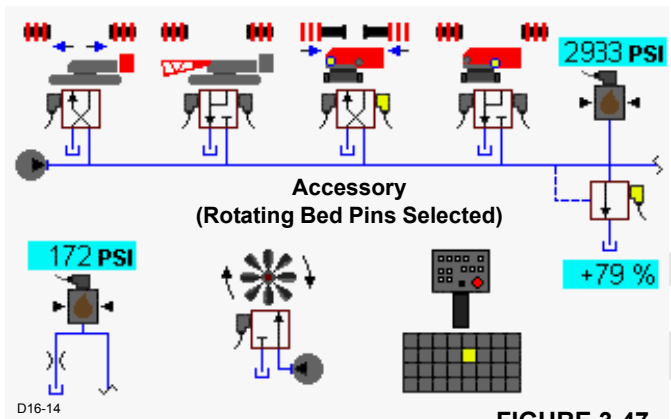

FIGURE 3-47

D16-14

Cab Tilt, Rigging Winch, and Mast Accessory Diagnostic Screen

Select cab tilt, rigging winch, and mast icon in screen **level 1** as shown in Figure 3-48. Press Enter button to go to **level 2**.

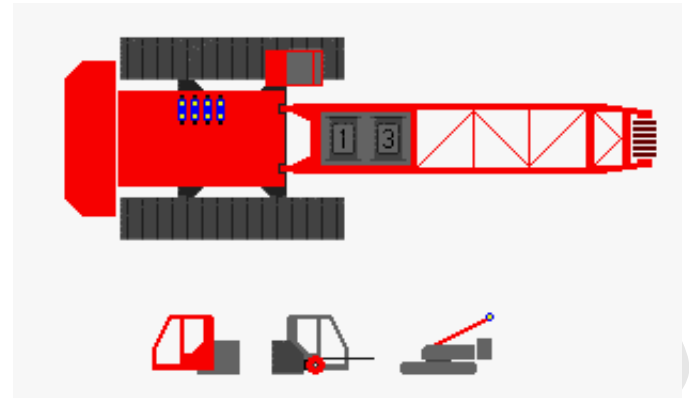

FIGURE 3-48

D16-15

For cab tilt, rigging winch, and mast raising cylinders screen see [Figure 3-49](#). In the following example, the mast raising cylinders in up direction on wireless remote is selected.

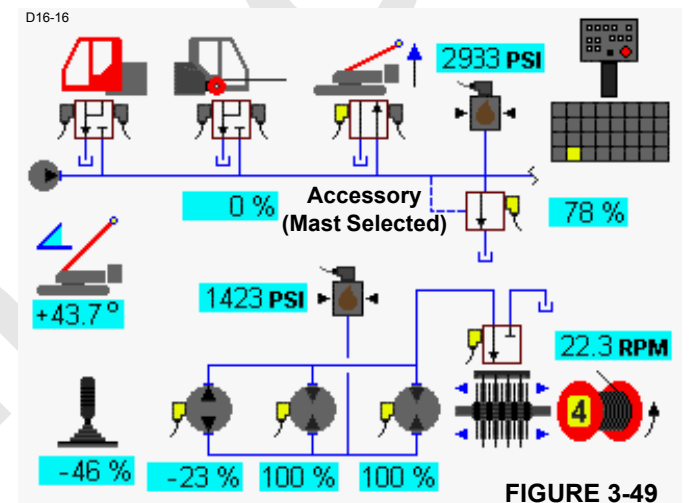

FIGURE 3-49

MAX-ER[®] Diagnostic Screen

Select MAX-ER[®] (optional) icon in screen **level 1** and press enter button to go to **level 2**. See MAX-ER[®] Operator Manual for complete MAX-ER[®] attachment information.

Function Mode Screens

See [Figure 3-50](#) for the following procedure.

The Function Mode screens are used to enable/disable modes and set operating parameter for the individual crane functions. This screen operates on four **levels**.

Level 1— Image of overall crane shown. Use Select buttons to highlight individual crane functions.

Level 2 — Shows the function mode screen for highlighted crane function. The selected mode or limit data box is highlighted blue. Use Select buttons to choose a mode or limit data box.

Level 3 — The selected mode or limit data box highlighted red. Use Select buttons to enable/disable a mode or to set a limit.

Level 4 — The selected mode or limit data data box highlighted green. Use Select buttons to adjust the value shown in data box.

To enable/disable modes or to set operating parameters for the individual crane functions:

1. Press Enter or Exit buttons as required to go to **level 1**. Use Select buttons to highlight desired crane function.
2. Press Enter button to go to **level 2**. Use Select buttons to choose the mode or limit data box to access. Press Enter button to go to **level 3**.
3. Use Select buttons to enable/disable mode or to adjust operational parameter.
4. Press Enter button to go to **level 4** if required. Use Select buttons to adjust operational parameter.
5. Press the Exit button as required to return to a previous level or to the Menu screen.

The yellow alert symbol is displayed if a system fault occurs. See Information screen to access faults.

On (1) and **off** (0) icons in some data boxes indicate and enable the electrical status of item.

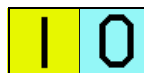

Drum Functions

Select drum functions 1 through 5 from screen shown below.

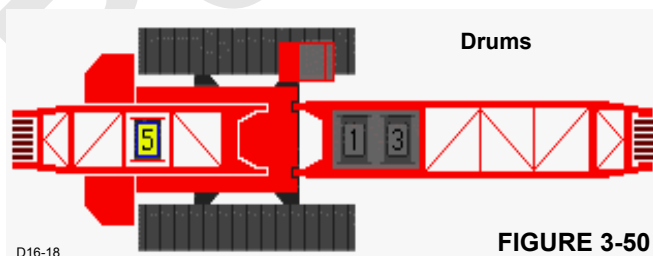

D16-18

FIGURE 3-50

Swing Functions

Select swing functions from screen shown below.

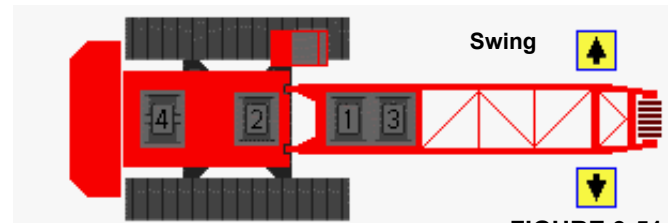

D16-18A

FIGURE 3-51

Travel Functions

Select travel functions from screen shown below.

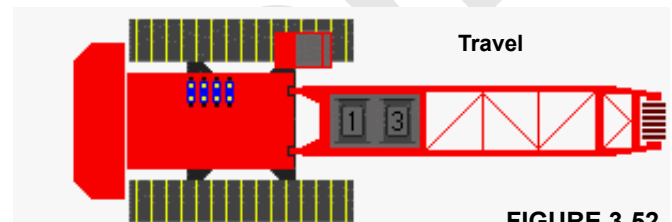

D16-18B

FIGURE 3-52

Setup Remote Functions

Select setup remote function from screen shown below.

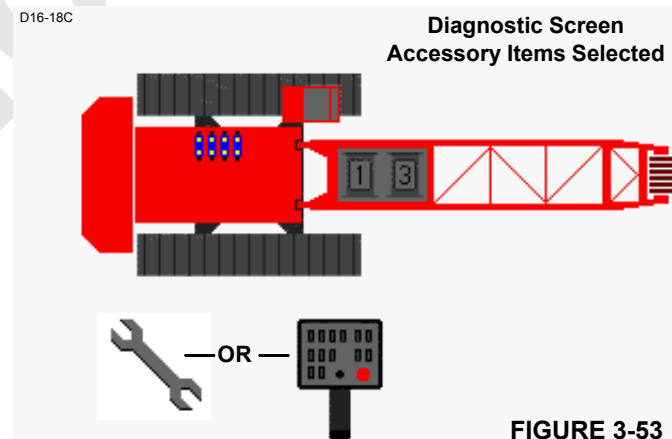

D16-18C

FIGURE 3-53

MAX-ER® Functions

Select MAX-ER® functions from MAX-ER® attachment screen. See MAX-ER® Operator Manual for complete MAX-ER® attachment information.

Drum, Swing or Track Speed Limits

See [Figure 3-54](#) in the following procedure.

Drum, swing, and crawler speeds can be selected. In **level 3**, the value shown in these data boxes can be adjusted with the Select buttons to limit the function speed between 25% and 100% of maximum capability.



FIGURE 3-54

Swing Pressure Limit

See [Figure 3-55](#) for the following procedure.

In **level 3**, the value shown in this data box can be adjusted with the Select buttons to limit swing pressure between 25% and 100% of maximum capability.



FIGURE 3-55

Rigging Winch Mode

See [Figure 3-56](#) for the following procedure.

In **level 3**, use the Select buttons to enable or disable rigging winch for the selected drum function. The rigging winch mode data box **shown disabled** will not appear in the function mode screen unless this feature is available.

When rigging winch is enabled, the computer selects control handle (selected handle display light is 0). If rigging winch is enabled for drum 4, the computer selects a load drum handle to control winch.

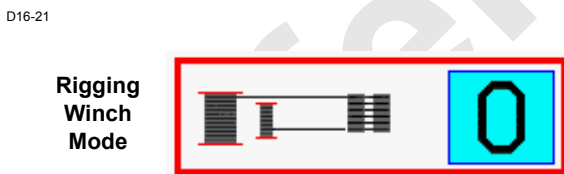

FIGURE 3-56

Boom or Swing Motion Limiter Mode

See [Figure 3-56](#) for the following procedure.

NOTE: Motion limiter mode data boxes do not appear unless the crane has this option.

In **level 3**, use the Select buttons to enable or disable the motion limiter mode. When in **level 3** with the motion limiter mode enabled, the controller monitors and stores the maximum right/left or up/down angles during operation. After exiting **level 3**, these angles are used to limit boom or swing motion.

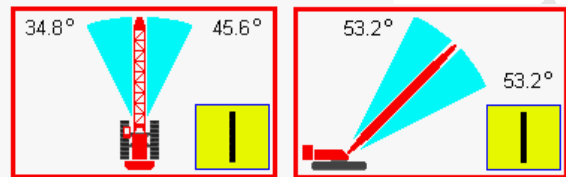

FIGURE 3-57

Setup Remote Control Mode

To turn on the crane setup remote control, see procedure under Crane Setup Remote Controls topic on [page 3-43](#).

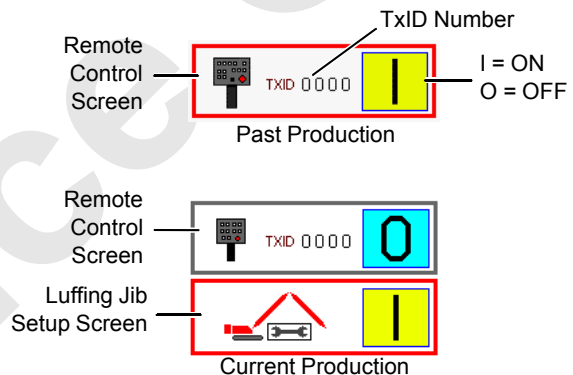

FIGURE 3-58

Fan Function

See [Figure 3-59](#) for the following procedure.

NOTE: Tier 4 equipped cranes only.

The fan speed can be set above a minimum 50% of rated speed in increments of 5% (to 55%, 60%, 65%, etc.). **This minimum is pre-set by the manufacturer and should only be adjusted by the manufacturer.**



FIGURE 3-59

Reference Only

THIS PAGE INTENTIONALLY LEFT BLANK

CAN Bus Screen

See [Figure 3-60](#) for the following procedure.

The CAN (Controller Area Network) bus diagnostic screen is for technicians. The screen displays CAN bus packet and node information, engine status, history status, and boom status. Any node that is yellow indicates that communication is lost to that node.

The CAN Bus screen operates on two **levels**:

Level 1 — Packet number data box highlighted blue

Level 2 — Packet number data box highlighted red

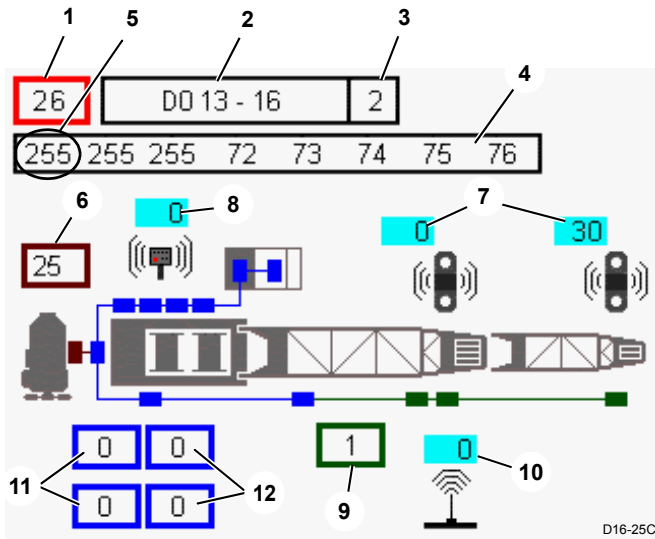

Item	Description	Item	Description
1	Packet Number	7	Drum Load Links
2	Packet Type	8	Remote Status
3	Packet Node Number	9	Boom Node Status
4	Packet Banks (8)	10	Wireless Receiver Status
5	Bank 1 Total	11	Crane Status
6	Engine Node Status	12	Crane History

FIGURE 3-60

Packet Information

The top row of the screen contains CAN Bus packet number (26). Enter the desired packet number in the first data box by using Select buttons.

Packet type (DO) is displayed on top middle data box.

Related node (2) is displayed in top last data box.

Packet contents are displayed in the eight banks under the row. Packet content and format depends on packet type. Many packets are not easily interpreted by those other than factory technical personnel and their content is not discussed in this publication.

Each individual input/output is assigned a number (identifier) in the binary system (powers of two). The identifiers of all inputs/outputs that are ON (active) for each bank are added for a total of 0 – 255. The number displayed for each bank is the **sum** of all identifiers that are ON in that bank. Each possible ON/OFF combination per bank has a unique total.

To determine the status of an individual digital input or output, you need to know the CAN packet number (see [Table 3-7](#) and [Table 3-8](#)). For example: **Drum 1 Brake** has a packet number of **CAN26-1-64**.

The first part of the Code Number (**26**) indicates that the individual input or output is located in **packet 26** of the CAN communications.

The second part of the Code Number (**1**) indicates the **bank** where the individual information is shown on the CAN screen.

The third part of the Code Number (**64**) is the item **identifier**.

Determine status of the individual input/output by checking the total in bank 1 (255). Find 255 in the numbered column of [Table 3-9](#) - Bank Identifier Numbers. In the corresponding row the identifier numbers that are ON in the bank are shaded. In the above example if **64** is shaded the **Drum 1 Brake** is ON.

Digital Output Disable Fault

See [Figure 3-60](#) for the following procedure.

The control system is capable of detecting an open or short circuit in most of the system's digital outputs. When **Fault 84-Digital Output Disable** is shown in fault section of Information screen, check for DOD fault in packets 36 through 41:

1. Scroll through packet numbers 36 through 41.
2. Banks 1, 2, and 3 of CAN bus screen should display number 255.
3. If a number less than 255 is displayed in banks 1, 2, and 3, use the Bank Identifier Numbers in [Table 3-9](#) to determine which bit(s) are **off**.
4. Use [Table 3-6](#) - Digital Output Disable, to determine what outputs are not working.
5. Investigate indicated outputs for short to ground, short to shield or other problem.

Engine Node Status

Engine displays node bus status that is for factory use only. Communication number should be under 64. See engine manufacturers manual for engine fault code information.

Crane Status

Two crane status banks on the left side display crane errors. Crane status banks should display zero.

The number displayed in the crane status top bank corresponds to the numbered communication errors listed below:

- 0 — Crane status normal.
- 1 — Node-2 is not communicating.
- 2 — Node-3 is not communicating.
- 4 — Node-4 is not communicating.
- 8 — Node-5 is not communicating.
- 16 — Node-7 is not communicating.
- 32 — Bin node is not communicating.
- 64 — Wireless remote is not communicating.
- 128 — Engine node is not communicating.

NOTE: Bottom crane status bank is not used at this time.

Crane History

Top crane history bank displays errors since power was cycled.

NOTE: Bottom crane history bank is not used at this time.

Load Link Status

The load link sensor icons indicate the selected load sensor operating status. The selected link sensor is operating normal if blue antenna icon is displayed. The following numbers indicate the type of communication error:

- 4 — is a calibration fault.
- 8 — is RF (radio frequency) state. The selected link sensor is not communicating.
- 64 — is a sign on error.

128 — indicates a RF (radio frequency) communication error.

Drum load link and wireless remote battery status displays:

- 16 and 32 On — 75% and up battery charge
- 32 On, 16 Off — 50% to 75% battery charge
- 32 Off, 16 On — 25% to 50% battery charge
- Both Off — 0% to 25% battery charge

Wireless Receiver Status

Wireless receiver status displays boom top and wireless receiver communication. The following numbers indicate the type of communication:

- 0 — Communication error.
- 1 — Boom top transmitter working.
- 2 — Rotating bed receiver working.

Boom Node Status

The boom node status displays boom top node and jib node communication. Zero is displayed if there is a communication error. Boom data box indicates what boom nodes may be available on the bus:

- 0 — No communication.
- 1 — is boom top node.
- 2 — is luffing jib node.
- 4 — is fixed jib node.
- 128 — indicates a node is present that is not currently identified.

Table 3-6 Digital Output Disable

CAN Packet Number	Item Description (Node Number)
36-1-1	Cab Base RCL Beacon (N2)
36-1-2	Handle (H4) Rotation Indicator (N2)
36-1-4	Handle (H2) Rotation Indicator (N2)
36-1-8	Front Wiper Switch (N2)
36-1-16	Overhead Wiper Switch (N2)
36-1-32	Handle (H3) Rotation Indicator (N2)
36-1-64	Handle (H1) Rotation Indicator (N2)
36-1-128	Handle Displays; Seat Switch (N2)
36-2-1	Travel 2-Speed; Travel Cruise Switch (N2)
36-2-16	Limit Bypass and Rigging Limit Switches (N2)
36-2-128	Drum Park Switches (N2)
36-3-64	Foot Throttle Output (N2)
37-1-1	Cab Tilt Up Solenoid (N3)
37-1-2	Cab Tilt Down Solenoid (N3)
37-1-4	Rear Rotating Bed Pins - Extend (N3)
37-1-8	Rear Rotating Bed Pins - Retract (N3)
37-1-16	Boom Hinge Pin – Extend (N3)
37-1-32	Boom Hinge Pin – Retract (N3)
37-1-64	Left Side RCL Capacity Alarm (N3)
37-1-128	Load Hoist (Drum 2) LS Motor Control (N3)
37-2-1	Boom/Mast Hoist (Drum 4) Pawl – Out (N3)
37-2-2	Boom/Mast Hoist (Drum 4) Pawl – In (N3)
37-2-4	Left Side Swing/Travel Alarm Solenoid (N3)
37-2-8	Accessory Proportional Relief Solenoid (N3)
37-2-16	Pump 4 Control – Drum 1/Drum 2 (N3)
37-2-32	Pump 4 Control – Drum 1/Drum 2 (N3)
37-2-64	Pump 3 Control – Drum 4/Drum 5 (N3)
37-2-128	Pump 3 Control – Drum 4/Drum 5 (N3)
37-3-1	Pump 6 Control – Drum 2/Drum 1 (N3)
37-3-2	Pump 6 Control – Drum 2/Drum 1 (N3)
37-3-4	Pump 2 Control – Left Travel/Drum 3 (N3)
37-3-8	Pump 2 Control – Left Travel/Drum 3 (N3)
37-3-16	Pump 1 Control – Right Travel/Drum 4 (N3)
37-3-32	Pump 1 Control – Right Travel/Drum 4 (N3)
37-3-64	Pump 5 Control – Swing (N3)
37-3-128	Pump 5 Control – Swing (N3)
38-1-1	Load/Luffing (Drum 3) Brake Sol. (N6)
38-1-2	Load/Luffing (Drum 3) RS Motor Cont. (N6)
38-1-8	Load/Luffing (Drum 3) Pawl In (N6)
38-1-16	Load/Luffing (Drum 3) Pawl Out (N6)
38-1-64	Load Hoist (Drum 1) Brake Solenoid (N6)
38-1-128	Load Hoist (Drum 1) LS Motor Control (N6)
38-2-1	Load Hoist (Drum 1) RS Motor Control (N6)
38-2-2	Load Hoist (Drum 1) Min. Bail Limit Sw. (N6)
38-2-4	Boom Hoist (Drum 5) Brake Solenoid (N6)
38-2-8	Boom Hoist (Drum 5) LS Motor Control (N6)
38-2-16	Boom Hoist (Drum 5) RS Motor Control (N6)
38-2-32	Boom Hoist (Drum 5) Pawl – In (N6)
38-2-64	Boom Hoist (Drum 5) Pawl – Out (N6)
39-1-1	Counterweight Pins Disengage (N4)
39-1-2	Drum 1 to Drum 2 Diversion Solenoid (N4)
39-1-4	Drum 2 to Drum 1 Diversion Solenoid (N4)
39-1-8	Drum 4 to Drum 5 Diversion Solenoid (N4)
39-1-16	Left Travel to Drum 3 Diversion Sol. (N4)
39-1-32	Right Travel to Drum 4 Diversion Sol. (N4)
39-1-64	Boom/Mast Hoist (Drum 4) Brake (N4)
39-1-128	Boom/Mast Hoist (Drum 4) Motor Cont. (N4)
39-2-4	Left Front Jack Solenoid - Extend (N4)
39-2-8	Left Front Jack Solenoid - Retract (N4)
39-2-16	Right Front Jack Solenoid - Extend (N4)
39-2-32	Right Front Jack Solenoid - Retract (N4)
39-2-64	Left Rear Jack Solenoid - Extend (N4)
39-2-128	Left Rear Jack Solenoid - Retract (N4)
39-3-1	Right Rear Jack Solenoid - Extend (N4)
39-3-2	Right Rear Jack Solenoid - Retract (N4)
39-3-4	Rigging Winch - Spool In (N4)
39-3-8	Rigging Winch - Spool Out (N4)
39-3-16	Mast Raising Cylinders – Extend (N4)
39-3-32	Mast Raising Cylinders – Retract (N4)
39-3-64	Front Rotating Bed Pins - Retract (N4)
39-3-128	Front Rotating Bed Pins - Extend (N4)
41-1-1	Boom/Mast Hoist (Drum 4) Motor Cont. (N5)
41-1-2	Engine Cooling Fan/Acc Enable Solenoid (N5)
41-1-8	Right Side RCL Capacity Alarm (N5)
41-1-64	Load Hoist (Drum 2) RS Motor Control (N5)
41-1-128	Load Hoist (Drum 2) Brake Solenoid (N5)
41-2-1	Right Side Swing/Travel Alarm (N5)
41-3-2	Travel Brake Release Solenoid (N5)
41-3-4	Travel Two Speed Solenoid (N5)
41-3-8	Swing Brake Release Solenoid (N5)
41-3-16	Swing Lock – In (N5) (Past Production)
41-3-32	Swing Lock–Out (N5)(Past Production)
41-3-64	Swing Bearing Grease Motor (N5)
41-3-128	Crawler Track Grease Motor (N5)

Digital Output Reference Chart

Table 3-7 Digital Outputs

CAN Packet Number	Item Description (Node Number)	CAN Packet Number	Item Description (Node Number)
CAN24-1-1	Cab Base RCL Beacon (N2)	CAN26-2-32	Boom Hoist (Drum 5) Pawl – In (N6)
CAN24-1-2	Handle (H4) Rotation Indicator (N2)	CAN26-2-64	Boom Hoist (Drum 5) Pawl – Out (N6)
CAN24-1-4	Handle (H2) Rotation Indicator (N2)	CAN27-1-1	Counterweight Pins Disengage (N4)
CAN24-1-8	Front Wiper Switch (N2)	CAN27-1-2	Drum 1 to Drum 2 Diversion Solenoid (N4)
CAN24-1-16	Overhead Wiper Switch (N2)	CAN27-1-4	Drum 2 to Drum 1 Diversion Solenoid (N4)
CAN24-1-32	Handle (H3) Rotation Indicator (N2)	CAN27-1-8	Drum 4 to Drum 5 Diversion Solenoid (N4)
CAN24-1-64	Handle (H1) Rotation Indicator (N2)	CAN27-1-16	Left Travel to Drum 3 Diversion Sol. (N4)
CAN24-1-128	Handle Displays; Seat Switch (N2)	CAN27-1-32	Right Travel to Drum 4 Diversion Sol. (N4)
CAN24-2-1	Travel 2-Speed; Travel Cruise Switch (N2)	CAN27-1-64	Boom/Mast Hoist (Drum 4) Brake (N4)
CAN24-2-16	Limit Bypass and Jib Up Limit Switches (N2)	CAN27-1-128	Boom/Mast Hoist (Drum 4) Motor Cont. (N4)
CAN24-2-128	Drum Park Switches (N2)	CAN27-2-1	Pump 7 Control – Accessory Pump (N4)
CAN24-3-64	Foot Throttle Output (N2)	CAN27-2-4	Left Front Jack Solenoid - Extend (N4)
CAN25-1-1	Cab Tilt Up Solenoid (N3)	CAN27-2-8	Left Front Jack Solenoid - Retract (N4)
CAN25-1-2	Cab Tilt Down Solenoid (N3)	CAN27-2-16	Right Front Jack Solenoid - Extend (N4)
CAN25-1-4	Rear Rotating Bed Pins - Extend (N3)	CAN27-2-32	Right Front Jack Solenoid - Retract (N4)
CAN25-1-8	Rear Rotating Bed Pins - Retract (N3)	CAN27-2-64	Left Rear Jack Solenoid - Extend (N4)
CAN25-1-16	Boom Hinge Pin – Extend (N3)	CAN27-2-128	Left Rear Jack Solenoid - Retract (N4)
CAN25-1-32	Boom Hinge Pin – Retract (N3)	CAN27-3-1	Right Rear Jack Solenoid - Extend (N4)
CAN25-1-64	Left Side RCL Capacity Alarm (N3)	CAN27-3-2	Right Rear Jack Solenoid - Retract (N4)
CAN25-1-128	Load Hoist (Drum 2) LS Motor Control (N3)	CAN27-3-4	Rigging Winch - Spool In (N4)
CAN25-2-1	Boom/Mast Hoist (Drum 4) Pawl – Out (N3)	CAN27-3-8	Rigging Winch - Spool Out (N4)
CAN25-2-2	Boom/Mast Hoist (Drum 4) Pawl – In (N3)	CAN27-3-16	Mast Raising Cylinders – Extend (N4)
CAN25-2-4	Left Side Swing/Travel Alarm Solenoid (N3)	CAN27-3-32	Mast Raising Cylinders – Retract (N4)
CAN25-2-8	Accessory Proportional Relief Solenoid (N3)	CAN27-3-64	Front Rotating Bed Pins - Retract (N4)
CAN25-2-16	Pump 4 Control – Drum 1/Drum 2 (N3)	CAN27-3-128	Front Rotating Bed Pins - Extend (N4)
CAN25-2-32	Pump 4 Control – Drum 1/Drum 2 (N3)	CAN29-1-1	Boom/Mast Hoist (Drum 4) Motor Cont. (N5)
CAN25-2-64	Pump 3 Control – Drum 4/Drum 5 (N3)	CAN29-1-2	Engine Cooling Fan/Acc Enable Solenoid (N5)
CAN25-2-128	Pump 3 Control – Drum 4/Drum 5 (N3)	CAN29-1-8	Right Side RCL Capacity Alarm (N5)
CAN25-3-1	Pump 6 Control – Drum 2/Drum 1 (N3)	CAN29-1-64	Load Hoist (Drum 2) RS Motor Control (N5)
CAN25-3-2	Pump 6 Control – Drum 2/Drum 1 (N3)	CAN29-1-128	Load Hoist (Drum 2) Brake Solenoid (N5)
CAN25-3-4	Pump 2 Control – Left Travel/Drum 3 (N3)	CAN29-2-1	Right Side Swing/Travel Alarm (N5)
CAN25-3-8	Pump 2 Control – Left Travel/Drum 3 (N3)	CAN29-2-2	Drum 2 Minimum Bail (N5)
CAN25-3-16	Pump 1 Control – Right Travel/Drum 4 (N3)	CAN29-3-2	Travel Brake Release Solenoid (N5)
CAN25-3-32	Pump 1 Control – Right Travel/Drum 4 (N3)	CAN29-3-4	Travel Two Speed Solenoid (N5)
CAN25-3-64	Pump 5 Control – Swing (N3)	CAN29-3-8	Swing Brake Release Solenoid (N5)
CAN25-3-128	Pump 5 Control – Swing (N3)	CAN29-3-16	Swing Lock – In (N5) (Past Production)
CAN26-1-1	Load/Luffing (Drum 3) Brake Sol. (N6)	CAN29-3-32	Swing Lock–Out (N5)(Past Production)
CAN26-1-2	Load/Luffing (Drum 3) RS Motor Cont. (N6)	CAN29-3-64	Swing Bearing Grease Motor (N5)
CAN26-1-8	Load/Luffing (Drum 3) Pawl In (N6)	CAN29-3-128	Crawler Track Grease Motor (N5)
CAN26-1-16	Load/Luffing (Drum 3) Pawl Out (N6)	CAN129-1-1	System Operation Alarm (N1)
CAN26-1-32	Load/Luffing (Drum 3) Min. Bail Limit (N6)	CAN129-1-4	RCL Warning L.E.D. (N1)
CAN26-1-64	Load Hoist (Drum 1) Brake Solenoid (N6)	CAN129-1-32	RCL Caution L.E.D. (N1)
CAN26-1-128	Load Hoist (Drum 1) LS Motor Control (N6)	CAN129-1-64	Displays 1 and 2 (N1)
CAN26-2-1	Load Hoist (Drum 1) RS Motor Control (N6)	CAN129-2-2	Drum Handle Display H1 (N1)
CAN26-2-2	Load Hoist (Drum 1) Min. Bail Limit Sw. (N6)	CAN129-2-8	Drum Handle Display H3 (N1)
CAN26-2-4	Boom Hoist (Drum 5) Brake Solenoid (N6)	CAN129-2-16	Drum Handle Display H4 (N1)
CAN26-2-8	Boom Hoist (Drum 5) LS Motor Control (N6)	CAN129-2-64	Drum Handle Display H2 (N1)
CAN26-2-16	Boom Hoist (Drum 5) RS Motor Control (N6)		

CAN Packet Number	Item Description (Node Number)	CAN Packet Number	Item Description (Node Number)
MAX-ER®			
CAN-28-1-1	Counterweight Lift Cylinder Extend (N7)	CAN-28-2-64	Right Front Jacking Cylinder Extend (N7)
CAN-28-1-2	Counterweight Lift Cylinder Retract (N7)	CAN-28-2-128	Right Front Jacking Cylinder Retract (N7)
CAN-28-1-64	Telescopic Beam Cylinder Extend (N7)	CAN-28-3-1	Right Rear Jacking Cylinder Extend (N7)
CAN-28-1-128	Telescopic Beam Cylinder Retract (N7)	CAN-28-3-2	Right Rear Jacking Cylinder Retract (N7)
CAN-28-2-1	Telescopic Beam Hinge Pin In (N7)	CAN-28-3-4	Right Wheel Steering Clockwise (N7)
CAN-28-2-2	Telescopic Beam Hinge Pin Out (N7)	CAN-28-3-8	Left Wheel Steering Counter-Clock. (N7)
CAN-28-2-4	Left Front Jacking Cylinder Extend (N7)	CAN-28-3-16	Right Wheel Steering Clockwise (N7)
CAN-28-2-8	Left Front Jacking Cylinder Retract (N7)	CAN-28-3-32	Right Wheel Steering Counter-Clock. (N7)
CAN-28-2-16	Left Rear Jacking Cylinder Extend (N7)	CAN-28-3-64	Left Wheel Brakes (N7)
CAN-28-2-32	Left Rear Jacking Cylinder Retract (N7)	CAN-28-3-128	Right Wheel Brakes (N7)

Digital Input Reference Chart

Table 3-8 Digital Inputs

CAN Packet Number	Item Description (Node Number)	CAN Packet Number	Item Description (Node Number)
CAN43-1-1	Handle (H4) Direction Signal (N2)	CAN129-3-4	Load Hoist (Drum 2) Park Switch (N1)
CAN43-1-2	Handle (H3) Direction Signal (N2)	CAN129-3-16	Load Hoist (Drum 2) Park Switch (N1)
CAN43-1-4	Swing Holding Brake Switch (N2)	CAN129-3-64	Travel Park Switch (N1)
CAN43-1-8	Swing Handle Direction Signal (N2)	CAN129-3-128	Cab Tilt Up Switch (N1)
CAN43-1-32	Boom Raise Cylinder Retract	CAN129-4-1	Display Enter Switch (N1)
CAN43-1-128	Boom Raise Cylinder Extend	CAN129-4-2	Confirm Switch (N1)
CAN43-2-1	Left Track Direction Signal (N2)	CAN129-4-4	Limit Bypass Switch (N1)
CAN43-2-2	Handle (H1) Direction Signal (N2)	CAN129-4-8	Display Scroll Up Switch (N1)
CAN43-2-4	Handle (H2) Direction Signal (N2)	CAN129-4-16	Jib Up Limit Bypass Switch (N1)
CAN43-2-8	Right Track Direction Signal (N2)	CAN129-4-32	Display Scroll Down Switch (N1)
CAN45-1-4	Super Charge Pressure Switch (N3)	CAN129-4-64	Travel Cruise Switch - On (N1)
CAN45-1-64	Hydraulic Charge Filter Alarm Switch (N3)	CAN129-5-1	Seat Switch (N1)
CAN45-1-128	Hydraulic Return Filter Alarm Switch (N3)	CAN129-5-2	Cab Tilt Down Switch (N1)
CAN47-1-8	Load/Luffing (Drum 3) Minimum Bail Limit (N6)	CAN129-5-4	DPF Regen Inhibit
CAN47-1-128	Load Hoist (Drum 1) Minimum Bail Limit (N6)	CAN129-5-8	Air Conditioning Compressor Clutch On (N1)
CAN51-1-64	Left Front Jacking Cylinder Limit (N7)	CAN129-5-16	DPF Regen Initiate
CAN51-1-128	Left Rear Jacking Cylinder Limit (N7)	CAN129-5--32	Engine Run/Start (N1)
CAN53-1-8	Maximum Boom Angle Limit Switch (N5)	CAN129-5-128	Boom/Mast Hoist (Drum 4) Park Switch (N1)
CAN55-1-128	Drum 2 Minimum Bail Limit (N5)	CAN129-6-4	Display 1 (N1)
CAN86-6-64	Block Up Limit Luffing/Fixed Jib Upper Pt. (N21)	CAN129-6-8	Travel 2-Speed Switch (N1)
CAN86-6-128	Block Up Limit Luffing Jib Lower Point (N21)	CAN129-6-16	Display 2 (N1)
CAN112-6-64	Block Up Limit Boom Lower Point (N20)	CAN129-6-32	Swing Park Switch - On (N1)
CAN112-6-128	Block Up Limit Boom Upper Point (N20)	CAN129-6-64	Display Exit Switch (N1)
CAN129-3-1	Boom Hoist (Drum 5) Park Switch (N1)	CAN129-6-128	Load/Luffing (Drum 3) Park Switch (N1)

Table 3-9 Bank Identifier Numbers

	1	2	4	8	16	32	64	128
1	■							
2		■						
3	■	■						
4			■					
5	■							
6		■						
7	■	■						
8				■				
9	■							
10		■						
11	■	■						
12				■				
13	■	■						
14			■					
15	■	■						
16					■			
17	■	■						
18					■			
19	■	■						
20			■					
21	■	■						
22				■				
23	■	■						
24					■			
25	■	■						
26			■					
27	■	■						
28					■			
29	■	■						
30			■					
31	■	■						
32					■			
33	■	■						
34			■					
35	■	■						
36					■			
37	■	■						
38					■			
39	■	■						
40			■					
41	■	■						
42					■			
43	■	■						

	1	2	4	8	16	32	64	128
44								
45	■							
46		■						
47	■	■						
48					■			
49	■	■						
50					■			
51	■	■						
52			■					
53	■	■						
54					■			
55	■	■						
56					■			
57	■	■						
58			■					
59	■	■						
60					■			
61	■	■						
62			■					
63	■	■						
64					■			
65	■	■						
66					■			
67	■	■						
68			■					
69	■	■						
70					■			
71	■	■						
72					■			
73	■	■						
74			■					
75	■	■						
76					■			
77	■	■						
78					■			
79	■	■						
80					■			
81	■	■						
82			■					
83	■	■						
84					■			
85	■	■						
86					■			

	1	2	4	8	16	32	64	128
87	■	■						
88								
89	■	■						
90								
91	■	■						
92								
93	■	■						
94								
95	■	■						
96								
97	■	■						
98								
99	■	■						
100								
101	■	■						
102								
103	■	■						
104								
105	■	■						
106								
107	■	■						
108								
109	■	■						
110								
111	■	■						
112								
113	■	■						
114								
115	■	■						
116								
117	■	■						
118								
119	■	■						
120								
121	■	■						
122								
123	■	■						
124								
125	■	■						
126								
127	■	■						
128								
129	■	■						

Dark shaded boxes indicate ON; white boxes OFF.

Table 3-9 Bank Identifier Numbers (continued)

	1	2	4	8	16	32	64	128
130								
131								
132								
133								
134								
135								
136								
137								
138								
139								
140								
141								
142								
143								
144								
145								
146								
147								
148								
149								
150								
151								
152								
153								
154								
155								
156								
157								
158								
159								
160								
161								
162								
163								
164								
165								
166								
167								
168								
169								
170								
171								
172								

	1	2	4	8	16	32	64	128
173								
174								
175								
176								
177								
178								
179								
180								
181								
182								
183								
184								
185								
186								
187								
188								
189								
190								
191								
192								
193								
194								
195								
196								
197								
198								
199								
200								
201								
202								
203								
204								
205								
206								
207								
208								
209								
210								
211								
212								
213								
214								
215								

	1	2	4	8	16	32	64	128
216								
217								
218								
219								
220								
221								
222								
223								
224								
225								
226								
227								
228								
229								
230								
231								
232								
233								
234								
235								
236								
237								
238								
239								
240								
241								
242								
243								
244								
245								
246								
247								
248								
249								
250								
251								
252								
253								
254								
255								

Dark shaded boxes indicate ON; white boxes OFF.

Camera Screen (Optional)

The camera screen (not shown) displays camera options and items for selecting and operating. The camera option includes up to three different cameras to monitor drum spooling and the area behind the crane.

Use Select buttons to select the camera screen on the Menu screen. Press Enter button to access the screen.

Use Select buttons to select desired camera view.

Press Exit button until Menu screen appears.

Pressure Test and Calibration Screen

The Pressure Test and Calibration Screen (see [Figure 3-61](#)) is used to initiate and monitor the four hydraulic test and calibration procedures described in this section.

The screen shows the pump commands and pressure levels for all primary crane functions. Use the data box in the upper left corner of the screen to select and start a specific test or calibration procedure.

Pressure Test and Calibration screen operates on two **levels**.

Level 1 — Test data box highlighted blue.

Level 2 — Test data box highlighted red. Use Select buttons to choose the test or calibration procedure.

All test and calibration procedures must be run at a particular engine speed. If a test is started at the wrong speed, the appropriate prompt shown below appears in the data box and the procedure is aborted.

Engine Off

The yellow engine pressure **0** icon indicates that the test must be run with engine off.

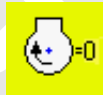

Engine Low Idle

The yellow engine pressure **down arrow** icon indicates that the test must be run with engine at low idle.



Engine High Idle

The yellow engine pressure **up arrow** icon indicates that the test must be run with engine at high idle.



The yellow open circuit icon indicates a circuit fault that must be serviced immediately.



The yellow short to ground icon indicates a circuit fault that must be serviced immediately.



Pressure Sender Test

See [Figure 3-61](#) for the following procedure.

The pressure sender test calculates the zero-pressure output level for each pressure sender. Pressure sender null (0) must be within 0.65 to 1.35 volts.

Perform this test when:

- A new pressure sender is installed.
- A new controller node that monitors pressure senders is installed.
- A new master node or master node software is installed.
- Pressure readings are noticeably in error.

Be aware that if there is any residual pressure in the system during the calibration process, the display pressure reading in the cab may not reflect actual system pressure. See Note on [page 3-70](#).

Test pressure senders as follows:

1. Stop engine and turn ignition switch to **run** position. Push Enter button to go to Pressure Test and Calibration screen from Menu screen.
2. Press Enter button to go to **level 2**. Use Select buttons to show PRESSURE SENDER icon in data box.
3. Press Confirm button to start test.
4. Test starts and percent of completion is displayed in data box.
5. When test is complete, pressure sender icon reappears in data box.



Pressure senders must show a signal within a specified range during this test. Any sender signal out of this range is highlighted yellow. Troubleshoot failed senders to determine cause of fault.

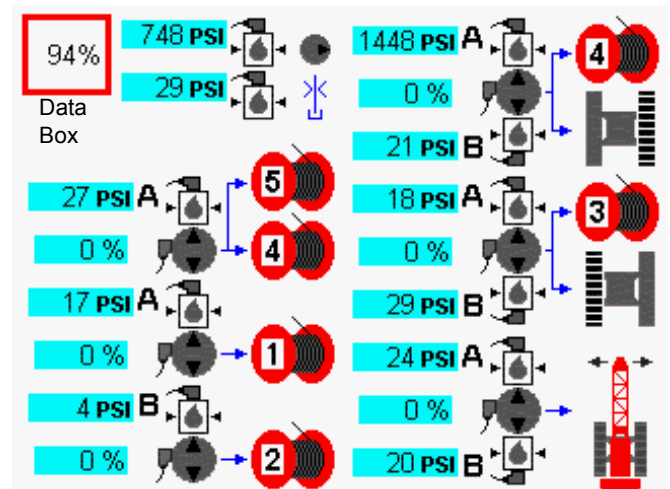

D16-26AA

FIGURE 3-61

NOTE: The cause of a failed pressure sender test or faulty display pressure reading may not be the pressure sender. The cause of the fault could be trapped air or hydraulic pressure in the system during the pressure sender test.

Before replacing a pressure sender, do the following:

- Perform pressure sender test.
- Attach an accurate hydraulic pressure gauge to the quick-coupler at the suspect pressure sender (see Section 2 of Service Manual).
- If pressure appears on the gauge, bleed the corresponding system so the gauge reads zero pressure.
- Repeat pressure sender test and check pressure on the display with the engine running at idle — the display reading and the gauge reading should be the same.
- Before replacing a pressure sender, check the signal voltage at the sender. It should be 1.00 volt against ground at 0 psi.

Control Calibration

See [Figure 3-62](#) for the following procedure.

Control calibration calculates the pump threshold command level for all drum and swing functions. The allowable range is 5 to 25% pump command signal for the hoist pumps and 2.5 to 20% in each direction for the swing pump(s).

Perform this calibration when:

- A new pump or motor is installed in a drum or swing function.
- A new master node or master node software is installed.
- Operation indicates threshold is in error.
 - Excessive handle motion or time required to initiate motion.

- Inability to smooth start motion.

Calibrate controls as follows:

1. Apply **all** park brakes and start engine. Set engine speed at **high idle**.
2. Press Enter button to go to Pressure Test and Calibration screen from Menu screen.
3. Press Enter button to go to **level 2**. Use Select buttons to show CONTROL CALIBRATION icon in data box. 
4. Press Confirm button to start test.
5. Calibration starts and percent of completion is displayed in data box.
6. When calibration is complete, control calibration icon reappears in data box.

Pump threshold command levels must be within a specified range during this test. Any pump requiring a threshold command level outside this range is highlighted yellow. Troubleshoot failed circuit to determine cause of fault.

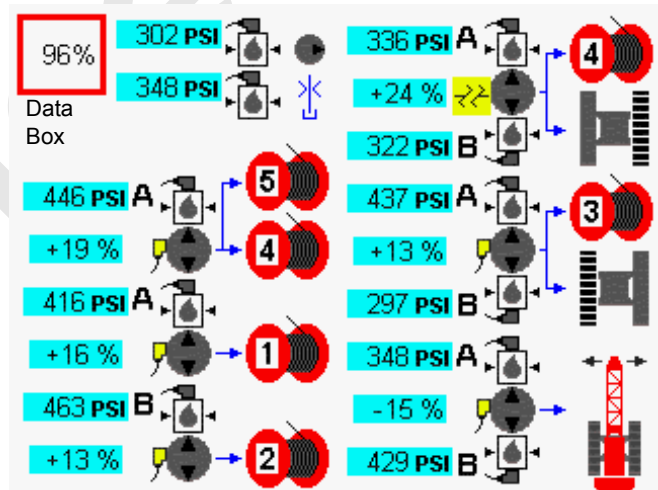

D16-27B

FIGURE 3-62

High Pressure Test

See [Figure 3-63](#) for the following procedure.

The high pressure test checks the ability of all primary crane functions to reach and hold high pressure. This test generally is used only as a shop procedure on new cranes. It can also be used as a quick way to test hydraulic components in primary hydraulic circuits.

CAUTION: Only perform this high pressure test when absolutely necessary and then only by a qualified service technician.



WARNING
High Pressure Hazard!

This test generates maximum pressure in the main hydraulic circuits. Defective brakes may allow unintended motion during test. Move the crane to an area where such motion is not a hazard.

We recommend an observer to monitor functions the operator cannot see.

Be prepared to stop engine if unintended motion occurs.

Test high pressure as follows:

1. Apply **all** park brakes and start engine. Set engine speed at **high idle**.
2. Press Enter button to go to Pressure Test and Calibration screen from Menu screen.

3. Press Enter button to go to **level 2**. Use Select buttons to show HIGH PRESSURE icon in data box. 
4. Press Confirm button to start test.
5. Test starts and percent of completion is displayed in data box.
6. When test is complete, high pressure icon reappears in data box.
7. Maximum pressure levels must be reached within a specific pump command range during this test. Any pump requiring a command in excess of this range or failed completely to generate maximum pressure is highlighted yellow. Troubleshoot failed circuit to determine cause of fault.

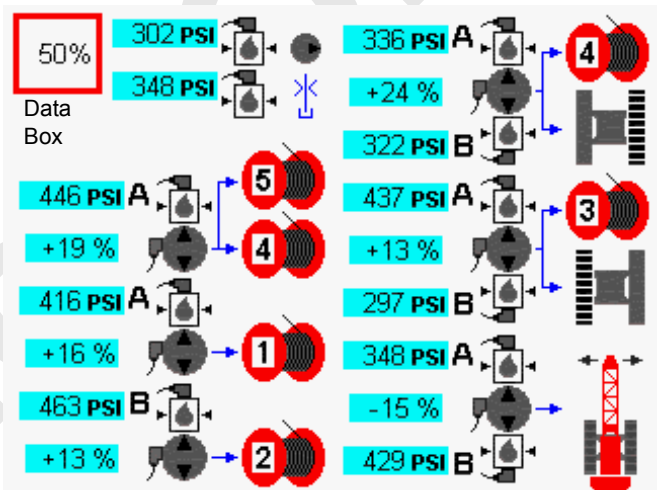

D16-28B

FIGURE 3-63

Charge Pressure Test

See [Figure 3-64](#) for the following procedure.

The charge pressure test checks the ability of all primary crane functions to build proper charge pressure. This test generally is used only as a shop procedure on new cranes. It can also be used as a quick way to test hydraulic components in primary hydraulic circuits. Charge pump pressure must be within 275 to 400 psi (19 to 27 bar).

Test charge pressure as follows:

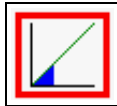
1. Apply **all** park brakes and start engine. Set engine speed at **low idle**.
2. Press Enter button to go to Pressure Test and Calibration screen from Menu screen.
3. Press Enter button to go to **level 2**. Use Select buttons to show LOW PRESSURE icon in data box. 
4. Press Confirm button to start test.
5. Test starts and percent of completion is displayed in data box.
6. When test is complete, charge pressure icon reappears in data box.

Charge pressure levels must be within a specified range during this test. Any pump that failed to maintain charge

pressure within a specified range is highlighted yellow. Troubleshoot failed circuit to determine cause of fault.

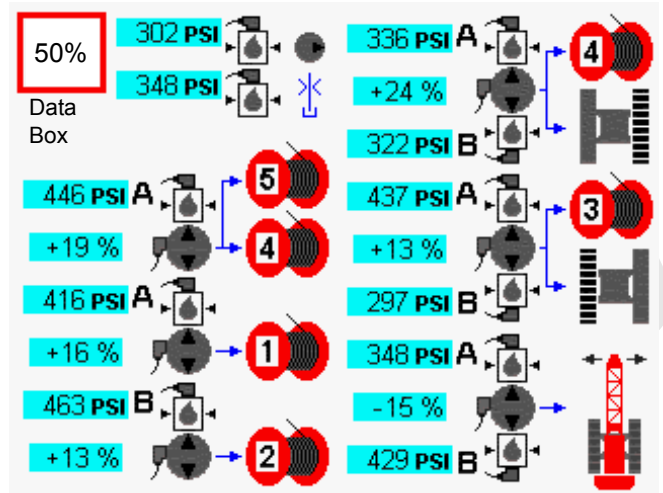

FIGURE 3-64

D16-29B

WIND CONDITIONS

Wind adversely affects lifting capacity and stability as shown in [Figure 3-65](#). The result could be loss of control over the load and crane, even if the load is within the crane's capacity.



WARNING

Tipping Crane Hazard!

Judgment and experience of qualified operators, job planners, and supervisors shall be used to compensate for affect of wind on lifted load and boom by reducing ratings or operating speeds, or a combination of both.

Failing to observe this precaution can cause the crane to tip or boom and/or jib to collapse. Death or serious injury to personnel can result.

Wind speed (to include wind gusts) must be monitored by job planners and supervisors.

The wind speed at boom or jib point can be greater than wind speed at ground level. Also be aware that the larger the sail area of the load, the greater the wind's affect on the load.

As a general rule, ratings and operating speeds must be reduced when:

Wind causes load to swing forward past allowable operating radius or sideways past either boom hinge pin.

For wind conditions specific to this crane, see Wind Conditions Chart at the end of this section or, if applicable, see wind conditions in Capacity Charts provided with crane and attachments.

A910

Forward stability is affected by wind on the rear of the boom. Wind applies a force to the boom and load that adds to the crane's overturning moment. This action has the same effect as adding load to the hook.

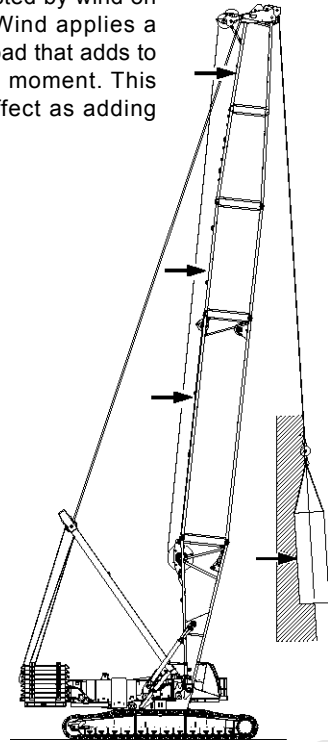

The wind's affect on the rear of the load increases load radius. This condition can result in an overload hazard, possibly causing the crane to tip or the boom to collapse.

To avoid this hazard, reduce operating speeds and load (see Wind Conditions Chart at end of this section or see wind conditions in Capacity Charts if applicable).

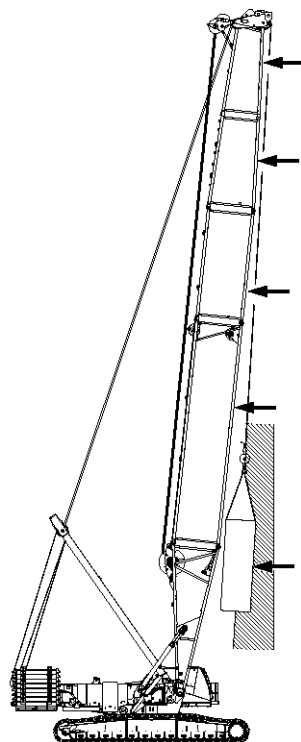

Backward stability is affected by wind on the front of the boom. This condition is especially dangerous when the boom is at or near the maximum angle when operating without load.

Wind forces on the front of the boom reduce the normal forward tipping effect of the boom. The crane can tip or the boom can collapse if this condition is not avoided.

The boom can buckle and collapse if the load contacts the boom.

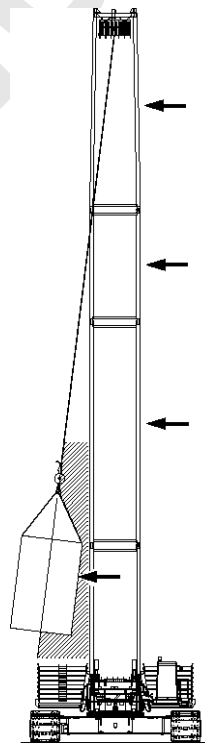

Boom strength is affected the most when the wind acts on the side of the boom.

The wind's affect on the side of the load can cause the load to swing out past the boom hinge pin. This condition can result in excessive side load forces on the boom, possibly causing the crane to tip or the boom to collapse.

To avoid this hazard, reduce operating speeds and load (see Wind Conditions Chart at end of this section or see wind conditions in Capacity Charts if applicable).

FIGURE 3-65

PREPARATION FOR COLD WEATHER

Crane Limitations

The static load carrying limitations of the steels used in Manitowoc cranes is not affected by cold weather. Manitowoc's capacity charts are acceptable for use in cold weather.

Dynamic loads (impact and shock) can affect the steels used in Manitowoc cranes when operating in cold weather. Dynamic loads are created by traveling, sudden application and release of load, and duty-cycle operations.

To prevent possible damage to the crane and its attachment when operating during cold weather Manitowoc recommends:

- At -5 to -22°F (-21 to -30°C) — Avoid impact or shock loading of crane and attachment. Operations involving hydraulic cranes should be conducted with regard to potential failure of hydraulic components.
- At -23 to -40°F (-31 to -40°C) — De-rate crane by 40% for all lift operations. Halting all lifts should be considered. Duty-cycle operation is prohibited.
- Below -40°F (-40°C) — All operation (lift and duty-cycle) is prohibited except in extreme emergencies, and then only with approval from a competent engineer who has de-rated the crane accordingly.

Wire Rope

Wire rope manufacturers indicate that wire rope will not become brittle in temperatures down to -30°F (-34°C). Lubrication may be a problem during extreme cold weather as normal wire rope lubricants may harden and chip off leaving the rope without lubrication.

Consult your wire rope supplier for recommended cold-weather lubricants.

Cold Weather Starting Aid

Engine startup at temperatures below 40°F (4°C) requires the use of a cold weather starting aid.



DANGER

Engine Explosion Hazard!

The crane engine has an air intake pre-heater, do not spray any combustible starting aid (ether) into air intake.

Pre-heater will ignite ether causing a severe explosion and/or burns.

Coolant and Oil Pan Heaters

A 120 volt coolant and oil pan heater can be installed in the engine. The heaters use an electric heating element to heat the coolant and oil inside the engine when the crane is idle. Each heater has an extension cord for connecting to an owner furnished electric power supply. The coolant heater must be capable of maintaining the engine's coolant and oil temperatures between 40 to 50°F (4 to 10°C). Contact the nearest engine distributor for availability and installation of the heaters.

Engine heaters must be unplugged when engine is running to prevent cooling system from overheating.

Cooling System

The cooling system must be kept full and be protected from freezing at the lowest expected ambient temperature. See the engine manual for antifreeze recommendations.

A mixture of 40% antifreeze and 60% water provides freeze protection to -35°F (-37°C). A mixture of 60% antifreeze and 40% water provides freeze protection to approximately -60°F (-51°C). 100% antifreeze will freeze at -10°F (-23°C).

Battery

To provide maximum cranking power and to prevent the battery from freezing, it must be kept fully charged (1.26 to 1.28 specific gravity) and warm when the crane is idle during cold weather.

It is recommended that the battery be stored indoors or heated with a battery heater when the crane is idle.

Be aware that:

- A battery with a 50% charge freezes at -16°F (-27°C). A battery with a 100% charge freezes at -70°F (-57°C).
- A battery with a 100% charge retains only 40% of its cranking power at 0°F (-18°C). At -20°F (-29°C), the same battery retains only 18% of its cranking power.

Engine Oil

See engine manufacturer's manual for recommendations.

Fuel Oil

See engine manufacturer's manual for recommendations.

Gear Oil

Hydraulic Cranes

Use a gear oil which meets MIL-L-2105C specification or API-GL-5 classification. Change to one of the following viscosities when the corresponding temperature range will be encountered:

- 75W-90 below: -10°F (-23°C)

- 80W-90 above: -10 to 100°F (-23 to 38°C)
- 85W-140 above: 100°F (38°C)

Hydraulic Oil

General

Optional thermostatically controlled heaters (120 or 240 volt) can be installed in the hydraulic tank to aid in cold-weather startup.

The heaters are designed to keep the oil temperature 30°F (17°C) warmer than ambient air temperature. Each heater has an extension cord for connecting to an owner furnished electric power supply.

Hydraulic tank heaters must be unplugged when engine is running to prevent hydraulic system from overheating.

Change the oil in the hydraulic system to ISO Grade 15 when the expected ambient temperature will remain at 32°F (0°C) or below.

Change the oil in the hydraulic system to ISO Grade 46 when the expected ambient temperature will remain above 32°F (0°C).

COLD WEATHER HEATER PACKAGE

General

The optional cold weather heater package is a 240 volt AC single phase power supply. The heaters preheat critical machinery and lubricant sumps during cold weather shutdown.

The 240 volt receptacle and circuit breaker panel is mounted on the rear of operator's cab (see [Figure 3-66](#)).

When operated in an arctic climate — outside temperature continuously below 0°F (-18°C) and -30°F (-34°C) — the crane should be equipped with the heaters identified in this section and lubricated with the lubricants listed in Section 5.

CAUTION

Machinery Damage!

Operating in an arctic climate without heaters can damage machinery during cold weather startup due to lack of lubrication.

Heater package described in this section may not provide adequate protection when operating below -30°F (-34°C). Contact Manitowoc dealer for recommendations.

Hydraulic Pump Damage!

To prevent damage to pumps, warm hydraulic oil to 60°F (16°C) minimum before operating the crane in an arctic climate.

Heaters

The heaters operate on 240 volt AC single phase electrical power supplied by a external power supply.

Past Production Cold Weather Package

The Past Production package includes the following heaters:

- Engine coolant (4000 watt)
- Engine oil sump (300 watt)
- Hydraulic oil tank right (two 500 watt)
- Hydraulic oil tank left (two 500 watt)
- Cab console (125 watt)
- Battery pad (two 75 watt, 240 volt)

Current Production Cold Weather Package

The Current Production package includes the following heaters:

- Engine coolant (4000 watt)
- Engine oil sump (300 watt)
- Hydraulic oil tank (2000 watt)
- Cab console (125 watt)
- Battery pad (two 75 watt, 240 volt)

Turning Heaters On

1. The external power supply must be disconnected. Then proceed as follows:
 - a. Check that main circuit breaker and each heater circuit breaker is off (see [Figure 3-66](#)).
 - b. Check that external power supply source is off.



WARNING

Electrocution Hazard!

Severe electric shock can cause death or serious injury. Crane owner/user shall make provisions for turning off electrical power supply before connecting power supply cord to crane.

- c. Connect external power supply cord to receptacle at rear of operator's cab.
- d. Turn on external power supply.
- e. Turn on main circuit breaker.
- f. Turn on each heater circuit breaker.

Turning Heaters Off

1. Turn off main circuit breaker.
2. Turn off each heater circuit breaker.

3. Perform the remaining steps only if power supply cord will be disconnected or electrical system is being serviced:
 - a. Turn off external power supply.
 - b. Unplug power supply cord from crane.

CIRCUIT BREAKERS

See Section 3 in the Service Manual for identification and location of circuit breakers used to protect crane's electric circuits.

Reference Only

PAST PRODUCTION COLD WEATHER PACKAGE

Item	Description
1	240 Volt Receptacle
2	Main Circuit Breaker
3	Engine Coolant Heater
4	Engine Oil Heater
5	Hydraulic Reservoir Heaters Left Side (2) or Top (1)
6	Hydraulic Reservoir Heaters Right Side (2)
7	Cab Front Console Heater
8	Battery Pad Heaters (2)
9	Circuit Breaker Load Center
9a	Circuit Breaker Decal (inside load center)

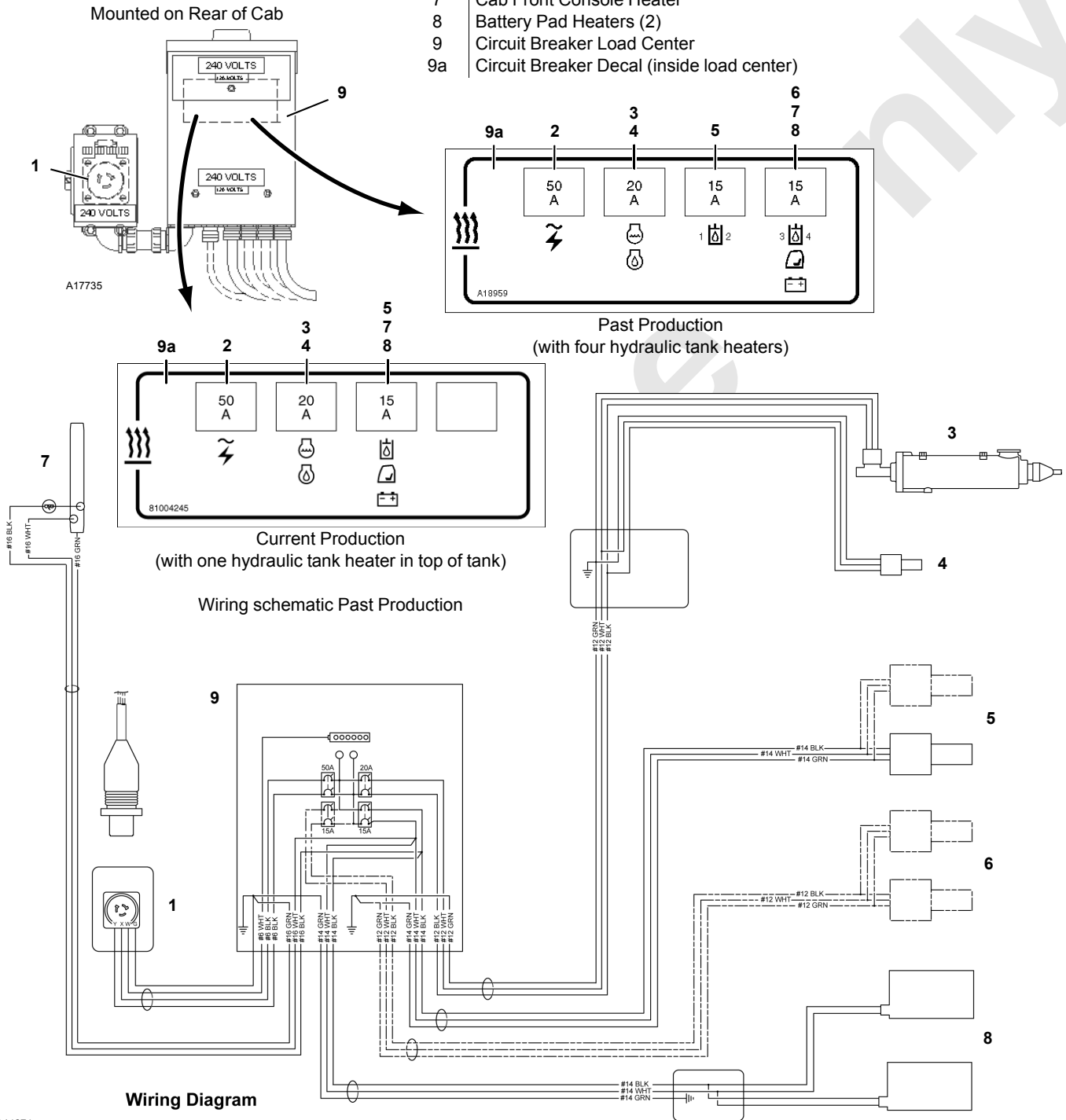

A14274

FIGURE 3-66

CURRENT PRODUCTION COLD WEATHER PACKAGE

Item	Description
1	240 Volt Receptacle
2	Main Circuit Breaker
3	Engine Coolant Heater
4	Engine Oil Heater
5	Hydraulic Reservoir Heater
6	Not Used
7	Cab Front Console Heater
8	Battery Pad Heaters (2)
9	Circuit Breaker Load Center
9a	Circuit Breaker Decal (inside load center)

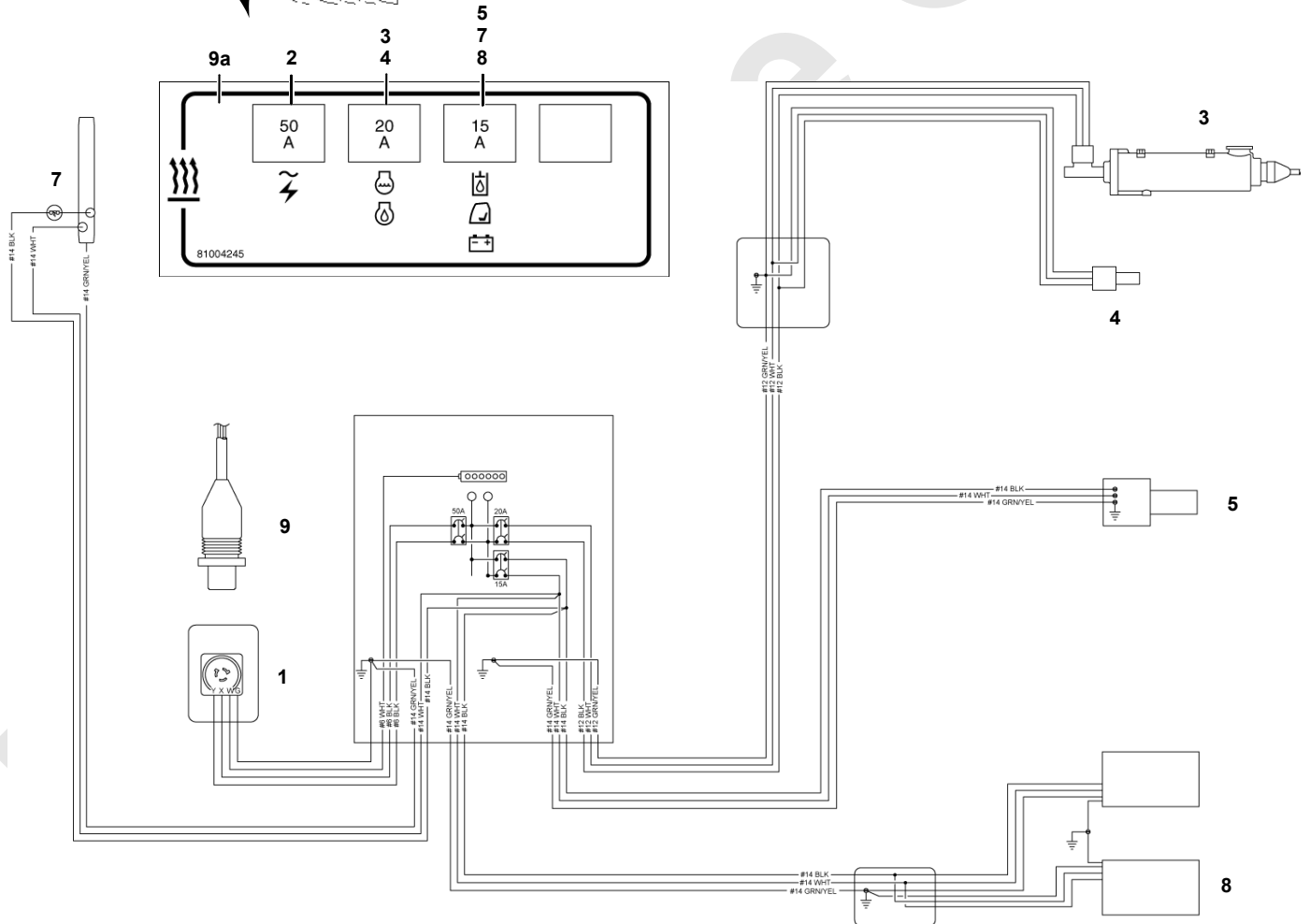
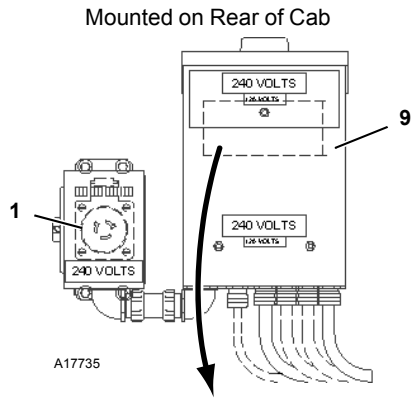

81004428_wire_diagram

FIGURE 3-67

THIS PAGE INTENTIONALLY LEFT BLANK

Reference Only

SECTION 4

SET-UP AND INSTALLATION

TABLE OF CONTENTS

Rigging Drawings	4-1
Liftcrane Mast Capacities	4-1
Optional Attachments	4-1
General Safety	4-1
Crane Orientation	4-1
Self-Erecting Equipment	4-1
Assist Crane Requirements	4-2
Assembly and Disassembly Notes	4-2
Assembly And Disassembly Area	4-2
Accessing Parts	4-2
Crane Weights	4-2
Handling Components	4-3
Retaining Connecting Pins	4-3
Pin and Connecting Hole Cleanliness	4-3
Hose and Cable Cleanliness	4-3
Cold Weather Mast Operation	4-3
Shipping Crane Components	4-6
Operating Controls	4-6
Pre-Start Checks	4-7
Engine	4-7
Gear Boxes	4-7
Hydraulic System	4-7
Starting Crane Engine	4-7
Crane Assembly	4-8
Install Exhaust Pipes (Past Production)	4-8
Remove Crane from Trailer	4-10
Raise Live Mast To Operating Position	4-13
Install Assembly Block	4-15
Handling Crawlers	4-17
Install Crawlers	4-19
Install First Crawler	4-19
Install First Crawler (continued)	4-21
Install Second Crawler	4-21
Install Counterweight	4-23
Install Carbody Counterweight	4-23
Install Crawler Platforms	4-25
Install Crawler Stairways	4-25
Install Crane Counterweight	4-27
Assemble Boom	4-29
Install Boom Butt	4-29
Remove Assembly Block	4-33
Connect Boom Butt to Boom	4-33
Node-6 Configuration with Mast Stop Limit Switch	4-36
Shipping Configuration (View A)	4-36
Working Configuration with Boom (View B)	4-37
Working Configuration with MAX-ER® (View C)	4-37
Crane Disassembly	4-37
Lower Boom	4-37
Disconnect Boom Butt from Boom	4-37
Install Assembly Block	4-38
Remove Boom Butt	4-38

Disassemble Boom	4-39
Remove Counterweight	4-39
Remove Crane Counterweight	4-39
Remove Carbody Counterweight	4-40
Remove Crawler Stairways	4-40
Store Crawler Platforms	4-40
Remove Crawlers	4-40
Remove First Crawler	4-41
Remove Second Crawler	4-41
Remove Assembly Block	4-41
Lower Live Mast To Shipping Position	4-42
Install Crane On Trailer	4-42
Remove Exhaust Pipes	4-42
Boom Ladder Assembly	4-45
General	4-45
Removing Ladders from Boom Butt	4-45
Installing Ladders on Boom Inserts	4-45
Storing Ladders in Boom Butt	4-45
Boom Rigging	4-46
Assist Crane Requirements	4-46
Blocked Crawler	4-46
Handling Components	4-46
Boom Assembly Drawing	4-46
Identifying Boom and Jib Components	4-47
Assemble Boom Sections	4-49
Connect Boom Straps	4-51
Install Intermediate Suspension	4-51
Install Standard Upper Boom Point	4-53
Install Extended Upper Boom Point	4-53
Install Load Line	4-58
Connect Boom Wiring	4-58
Perform Pre-Raising Checks	4-58
Boom Removal	4-58
Wire Rope Installation	4-62
Wire Rope Storage	4-62
Removing Wire Rope from Shipping Reel	4-62
Seizing and Cutting Wire Rope	4-62
Anchoring Wire Rope to Drum	4-63
Drum Guards	4-63
Winding Wire Rope onto Drum	4-65
Anchoring Wire Rope to Wedge Socket	4-67
Anchoring Wire Rope to Button Socket	4-67
Breaking in Wire Rope	4-67
Drum Kicker Adjustment	4-68
General	4-68
Adjustment	4-68
Pad Eye Usage for Wire Rope Reeving	4-68
General	4-68
Safety	4-68
Rigging Winch Operation	4-70
Selecting Rigging Winch Mode	4-70
Operating Rigging Winch	4-70
Free-Spool Operation	4-70
Power Operation	4-71
Reeving – Load Block	4-72
Load Block Identification	4-72
Wire Rope Specifications	4-72
Wire Rope Installation	4-72

Duplex Hook	4-72
Guide Sheaves and Drums	4-72
Load Block Reeving	4-72
Reeving – Live Mast	4-79
General	4-79
Wire Rope Specification	4-79

Reference Only

THIS PAGE INTENTIONALLY LEFT BLANK

SECTION 4

SET-UP AND INSTALLATION

RIGGING DRAWINGS

For boom and jib rigging drawings that apply to your crane, see the end of this section.

LIFTCRANE MAST CAPACITIES

Lifting capacities for the live mast are located at the end of this section.

OPTIONAL ATTACHMENTS

If applicable, instructions for optional attachments that apply to your crane are located at the end of this section.

GENERAL SAFETY

To prevent accidents that can result in death or injury during crane assembly and disassembly, comply with following general safety information and with specific safety information contained in assembly and disassembly steps.



WARNING

Avoid Death or Serious injury!

Read and understand setup and installation instructions in this section before attempting to assemble or disassemble the crane.



WARNING

Tipping/Overload Hazard!

Avoid tipping crane over or collapsing live mast:

- Assemble and disassemble the crane on a firm, level, uniformly supporting surface.
- Do not exceed swing limits and mast lifting capacities given in [Table 4-2](#).
- Keep the crane level when operating carbody jacks.



WARNING

Avoid Falling Off Crane and Boom!

It is necessary to climb onto the crane and boom during assembly and disassembly steps.

Use sturdy owner furnished ladders or an approved personnel hoist to gain access to areas which cannot be reached from ladders or steps provided with the crane.



WARNING

Moving Parts/Pinch Points!

Avoid death or crushing injury during crane assembly and disassembly:

- Assembly personnel — take every precaution to prevent injury when working near moving parts.
- Maintain communication between operator and assemblers to avoid accidents.
- Do not raise or lower live mast until all personnel are off the crane.
- Keep unauthorized personnel well clear of the crane.



WARNING

Falling Load Hazard!

To prevent lifting equipment from failing and load from dropping, crane owner/user shall verify the following prior to each lift:

- All lifting equipment (shackles, hooks, slings, blocks) has been properly maintained and is safe for use.
- All lifting equipment has a capacity equal to or greater than load to be lifted.

CRANE ORIENTATION

The terms RIGHT, LEFT, FRONT, REAR used in this section refer to the operator's right, left, front, and rear sides when seated in the operator's cab looking forward. Crawler pin handles on front of carbody.

SELF-ERECTING EQUIPMENT

The 16000 is equipped with the following self-erect components for assembly and disassembly:

1. Carbody jacks with pads for lifting the crane onto and off the trailer. The carbody jacks are also used to raise the crane during crawler repositioning.
2. Hydraulically actuated pins for connecting and disconnecting the crawlers to and from the carbody.
3. Hydraulically actuated arms for raising and lowering the live mast from and to the transport position.
4. Live mast which serves as a boom to install the crane's crawlers, carbody counterweights, and boom butt to handle other components as required.
5. 45 USt (41 t) load block and 4-leg sling with hooks for handling parts.

ASSIST CRANE REQUIREMENTS

An assist crane is required for handling and installing the following components:

- Crane (rotating bed) counterweight tray and boxes
- Catwalks and steps

See Crane Weights in Section 1 for weights of components.

ASSEMBLY AND DISASSEMBLY NOTES

The crane, boom, and jib must be assembled and disassembled by experienced personnel trained in erection and operation of construction cranes.

Read and become thoroughly familiar with the instructions in the applicable capacity charts, in this section, and in the rigging drawings at the rear of this section before attempting to assemble, operate, or disassemble the crane.

Contact your Manitowoc dealer for assistance if any procedure is not fully understood.

ASSEMBLY AND DISASSEMBLY AREA

Select an assembly/disassembly area that has a firm, level, uniformly supporting surface. Make sure the area is large enough to accommodate the crane and the selected boom length, movement of trucks with trailers, and movement of an assist crane.

Set carbody jack pads on a flat, firm foundation that will support the load placed on them. See [Table 4-1](#) for loadings.

Do not set the carbody jack pads in holes, on rocky ground, or on extremely soft ground.

If necessary, use wood blocking or steel plates under the carbody jack pads to properly distribute loading. The wood blocking or steel plates must be:

- Free of defects
- Strong enough to prevent being crushed or bent
- Of sufficient length and width to prevent settling under load

Contact Manitowoc Crane Care Lattice Team for ground bearing information.

Table 4-1
Carbody Jacks Load Data

Maximum load on each jack — 123,000 lb (55 792 kg)
Jack pad diameter — 30.5 in (775 mm)
Jack pad weight — 100 lb (45,4 kg)

ACCESSING PARTS

Some parts of the crane, boom, and jib cannot be reached from the ground. Take necessary precautions to prevent

slipping and/or falling off the crane or boom during assembly, disassembly, maintenance, or other work. ***Falling from any height could result in serious injury or death.***

Owner/user shall provide workers with approved ladders or aerial work platforms to access those areas of the crane, mast, boom, and jib that cannot be reached from ground or from steps, ladders, catwalks, and platforms provided by Manitowoc.

Adhere to local, state, and federal regulations for handling personnel and personnel fall protection.

Do not use top of mast or boom as a walkway.

Optional boom ladders (stored in boom first 40 ft [12 m] insert) are available from Manitowoc. If your crane has ladders, see the [Boom Ladder Assembly](#) instructions.

CRANE WEIGHTS

See Crane Weights in Section 1 for overall weight of the crane and individual weights of components.

HANDLING COMPONENTS

The major components are equipped with lifting lugs which are identified in the assembly and disassembly steps.

CAUTION

Personal Injury or Property Damage!

Ensure the boom straps remain properly secured in the shipping position to the boom insert or boom top during transportation loading or unloading and assembly or disassembly of the boom. Straps could shift or fall resulting in personal injury, property damage, or lacing damage if not properly secured.

When lifting lugs are not provided, use nylon lifting slings. If wire rope or chain slings are used, install protective covering (such as sections of rubber tire) between slings and component being lifted.

It is owner's/user's responsibility to ensure that all lifting slings, hooks, and shackles are in safe working order and capable of handling loads applied to them.

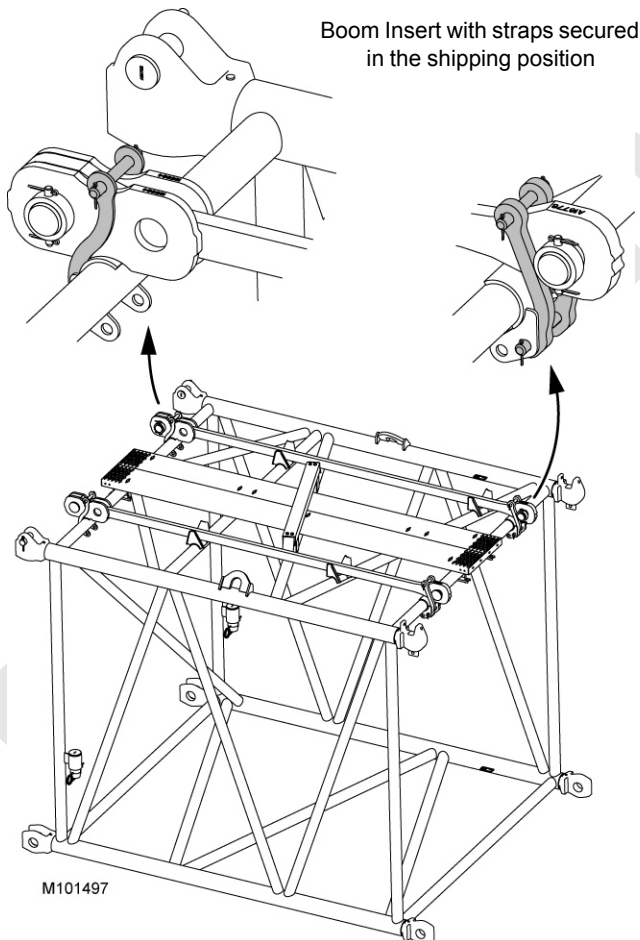

RETAINING CONNECTING PINS

Connecting pins are retained in various ways:

- Snap pins
- Quick-release pins
- Cotter pins
- Keeper plates with cap screws and lock washers

Do not operate the crane until all connecting pins are installed and properly retained.

PIN AND CONNECTING HOLE CLEANLINESS

To prevent dirt from damaging closely machined surfaces of pins and connecting holes:

- Thoroughly clean all pins and connecting holes.
- Apply a light coat of grease to all pins and connecting holes.

HOSE AND CABLE CLEANLINESS

To prevent dirt from entering the hydraulic systems or from damaging the electric connectors:

- Thoroughly clean the hydraulic fittings and the electric connectors before connecting them.
- Thoroughly clean the dust caps before attaching them to hoses, tubes, or cables.
- Do not drag the hydraulic hose fittings, the hydraulic hoses, the electric cable connectors, or the electric cables on the ground.

NOTE: Apply a light coat of silicone lubricant to the threads of all dust caps, couplers, and connectors to help in preventing the threads from seizing.

COLD WEATHER MAST OPERATION

The live mast, live mast cylinders, and live mast arms can be damaged when attempting to lower the live mast (to rear) during cold weather.

Do not attempt to lower the live mast with the mast hoist during cold weather until the following steps have been performed:

- Temperature of hydraulic oil warmed up to at least 60°F (16°C)
- Mast cylinders fully extended and retracted twice to fill cylinders with warm oil

Component Identification

Item	Description
1	Live Mast
2	Handling Pendant (Mast and Boom Butt)
3	Load Block — 45 USt (41 t)
4	4-Leg Chain Sling
5	Operator's Cab
6	Crawler Assembly
7	Rotating Bed Adapter Frame
8	Carbody
9	Carbody Jacks
10	Carbody Counterweight (both ends)
11	Live Mast Assist Arm (1 each side)
12	Rotating Bed
13	Boom Hoist
14	Crane (Rotating Bed) Counterweight
15	Boom Hoist Wire Rope

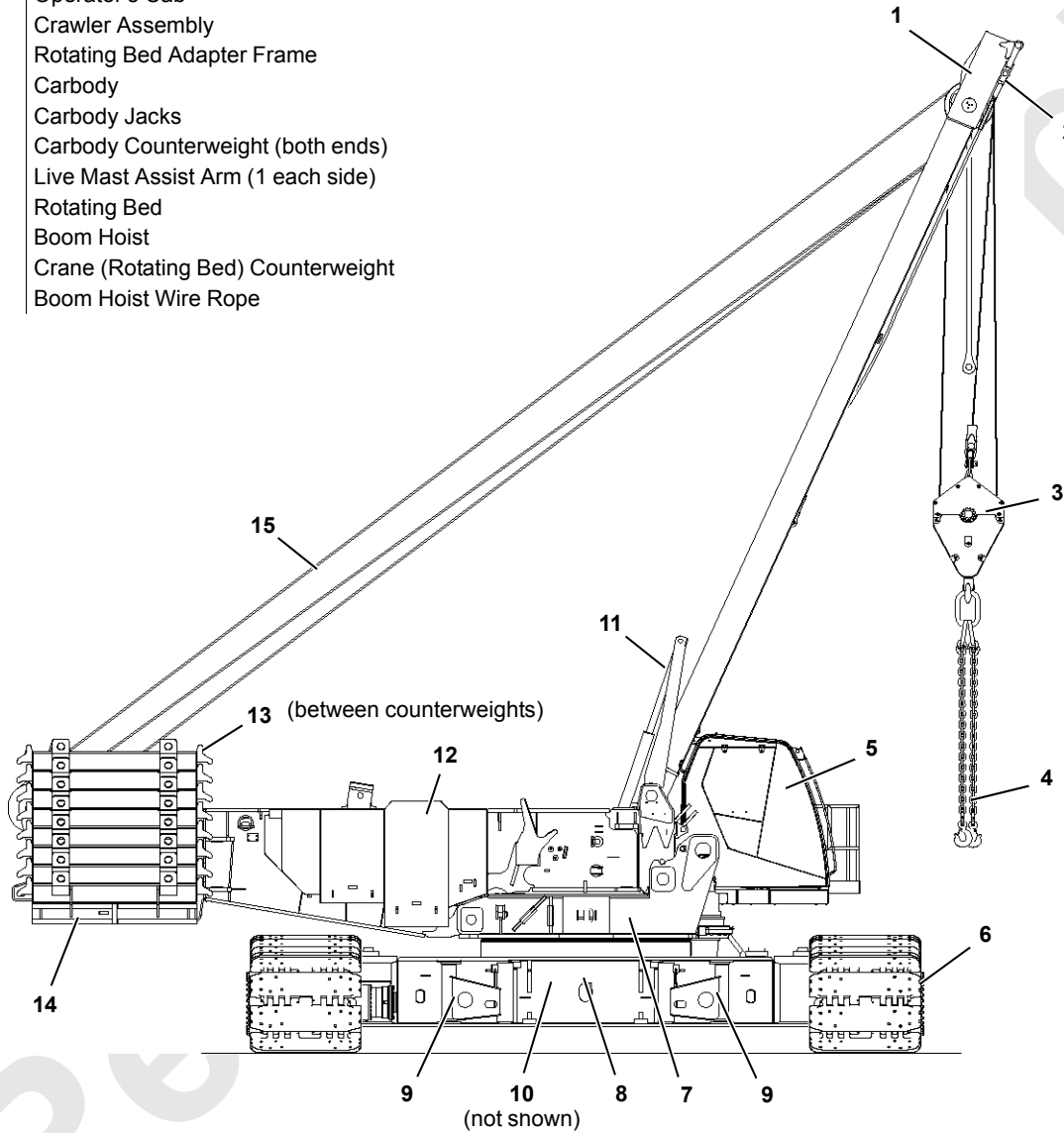

FIGURE 4-1

Table 4-2
Operating Limitations

See *Liftcrane Mast Capacities Chart* at the end of this section for detailed lifting capacities.

Crane Configuration	Swing	Max Capacity	Max Radius
<ul style="list-style-type: none"> Crane on carbody jacks (rotating bed, adapter frame, and carbody) Live mast raised or lowered (NOTE 1) No assembly block No crawlers No counterweight 	NO!		
<ul style="list-style-type: none"> Crane on carbody jacks (rotating bed, adapter frame, and carbody) Live mast in operating range (see Figure 4-9). Assembly block installed (NOTE 2) No crawlers installed (handling 1st crawler) No counterweight 	10° Either Side of Center See Figure 4-10 , View E	75,000 lb (34 019 kg)	20 ft (6,1 m)
<ul style="list-style-type: none"> Crane on carbody jacks (rotating bed, adapter frame, and carbody) Installing crawlers with mast No counterweight 	2nd Crawler Must be Lifted Over <i>Opposite</i> Side of 1st Crawler.		
<ul style="list-style-type: none"> Crane on crawlers Counterweight installed or removed Handling loads with live mast 	360°		

NOTE 1 Maximum mast angle = 156°

NOTE 2 Chain sling and 3-part line required

4-2

Rotating Bed/Adaptor/Carbody

- Length 43 ft, 6 in (13,26 m)
- Width 9 ft, 10 in (3,00 m)
- Height 10 ft, 6 in (3,20 m)
- Weight 143,260 lb (64 982 kg)

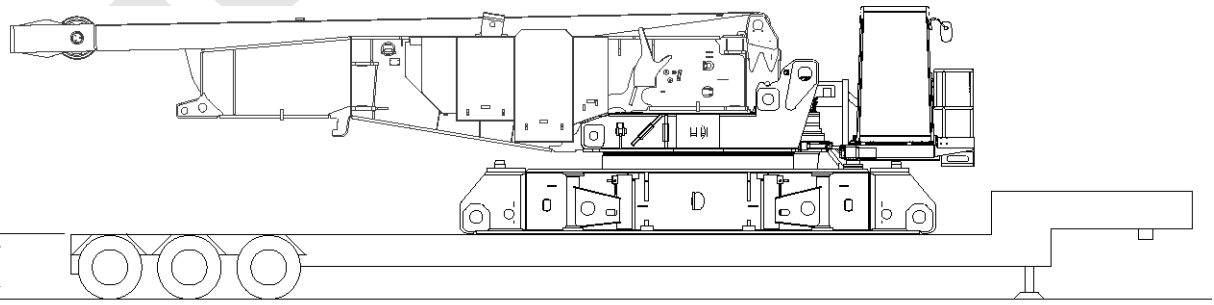

45 in (1 143 mm)
Maximum Deck Height

FIGURE 4-2

SHIPPING CRANE COMPONENTS

To ensure the crane's self-erecting system can load and unload the carbody and upperworks assembly, the trailer must meet the specifications given in [Figure 4-2](#).

It is the owner/user's responsibility to ensure the following:

- All trailer loads comply with local, state, and federal transportation requirements.
- **All crane components are properly blocked and secured so they cannot shift or fall off trailers.**
- To avoid damage to components:

Use nylon tie-downs to secure components as shown in [Figure 4-3](#), View A.

If chain tie-downs are used, install protective covering (such as sections of rubber tire) between the chain and component being secured as shown in [Figure 4-3](#), View B.

When securing boom sections, wrap tie-downs over chords — never over lacings. Keep tie-downs as close to blocking as possible (View A) to prevent bending the chords.

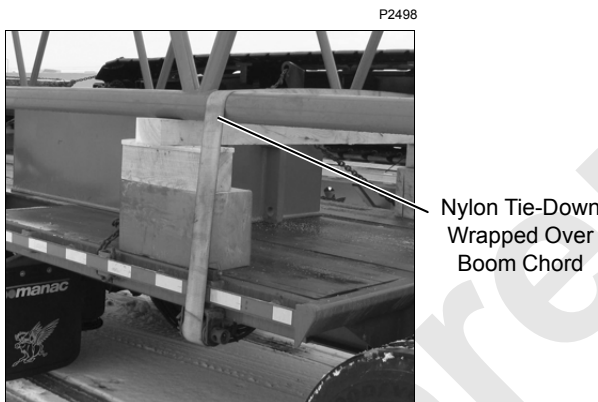

View A

Chain Tie-Down Wrapped Over Boom Chord

Protective Covering (section of rubber tire)

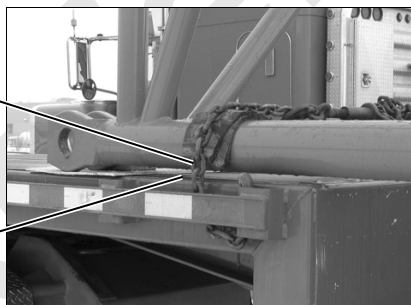

View B

FIGURE 4-3

OPERATING CONTROLS

To use the live mast as a boom for self-erecting the crane, the Liftcrane Mast Capacities Chart must be selected in the

Rated Capacity Indicator/Limiter (RCL/RCI) Configuration screen. See the RCI/RCL manual for instructions.

The boom hinge pins, upper counterweight cylinder pins, cab raise/lower cylinder, and mast assist cylinders are controlled by switches on the hand-held radio remote control ([Figure 4-4](#)). The remote control also selects engine speed.

The remote control must be turned on in the main display. See Remote Controls topic in Section 3 for remote control operating instructions.



Remote Control Stored in Rear of Operator's Cab

FIGURE 4-4

The carbody jacks are controlled by four manual handles at front of carbody ([Figure 4-7](#)).

The swing and travel alarm will sound if the rotating bed gets 3 degrees out of level. Operation will not stop, but the operator should use caution.

Operation will stop and the CRANE OUT OF LEVEL WHEN JACKING icon will appear on the fault screen if the rotating bed gets 4-1/2° out of level. The operator shall readjust the carbody jacks in the safe direction to continue operation.

CRANE OUT OF LEVEL WHEN JACKING

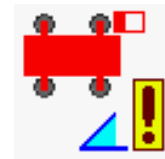

WARNING
Tipping Hazard!

Do not allow carbody to go more than 4-1/2° out of level while jacking.

Jacks could buckle allowing carbody and rotating bed to tip over.

PRE-START CHECKS

Make the following checks before starting the engine upon arrival at the assembly site. See Section 3 for starting instructions.

Engine

1. Check for leaks.
2. Check fuel, oil, and coolant levels.
3. Repair or refill as required.

Gear Boxes

1. Check for leaks.
2. Check levels.
3. Repair or refill as required.

Hydraulic System

1. Check for leaks.
2. Check level.
3. Repair or refill as required.
4. Make sure hydraulic shut-off valve is open.

STARTING CRANE ENGINE

The engine may not start (faults will occur) until terminator plugs are connected as shown in [Figure 4-5](#).

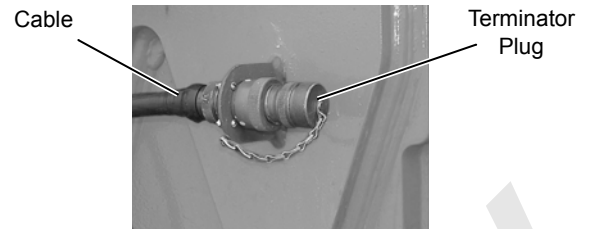

P2235

View A

On Right Outboard or
Inboard Side of Rotating Bed

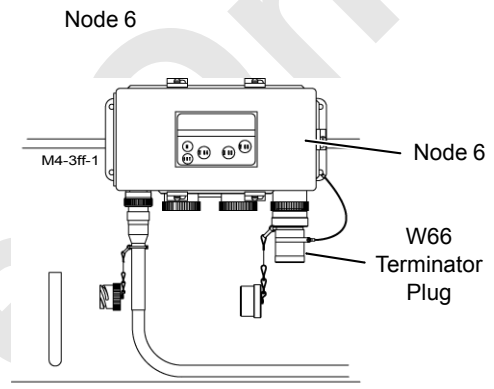

Node 6

M4-3F-1

Node 6

W66
Terminator
Plug

View B

On Front of Rotating Bed

FIGURE 4-5

CRANE ASSEMBLY

Install Exhaust Pipes (Past Production)

IMPORTANT Perform following steps before starting engine if equipped with Past Production (non-Tier 4) removable exhaust outlet pipes as shown in [Figure 4-6](#).

See [Figure 4-6](#) for the following procedure.

1. Remove rear enclosure panels (1, View A).
2. Unhook springs (4, View B) from clips (5) and remove both rain caps (3) from shipping position.
3. Store rain caps (3) in enclosure frame (View A).
4. Remove both exhaust pipes (2) from shipping position (View A).
5. Install both exhaust pipes (2) in working position (View B).
6. Connect springs (4, View B) to clips (5).
7. Install rear enclosure panels (1).

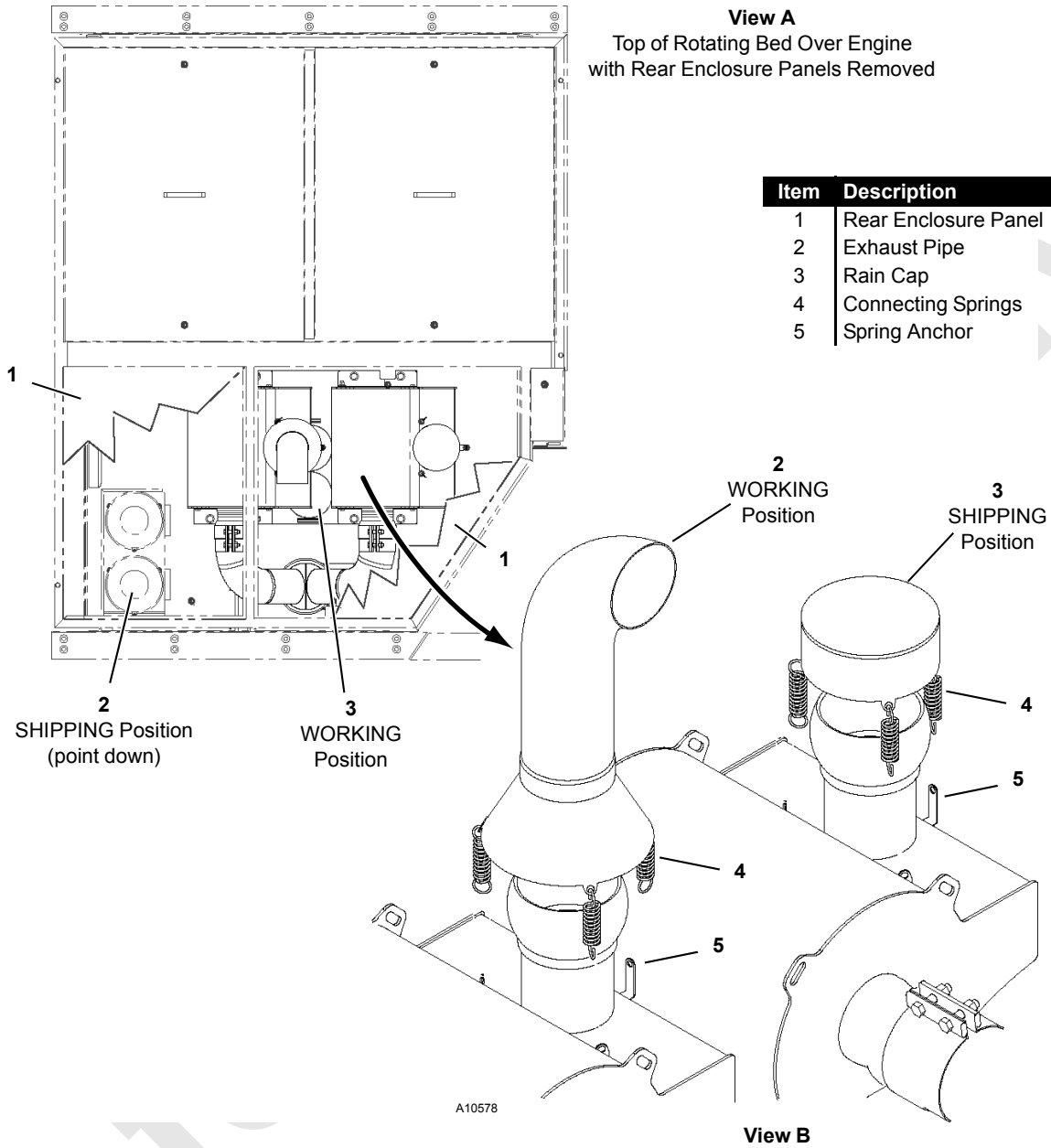

FIGURE 4-6

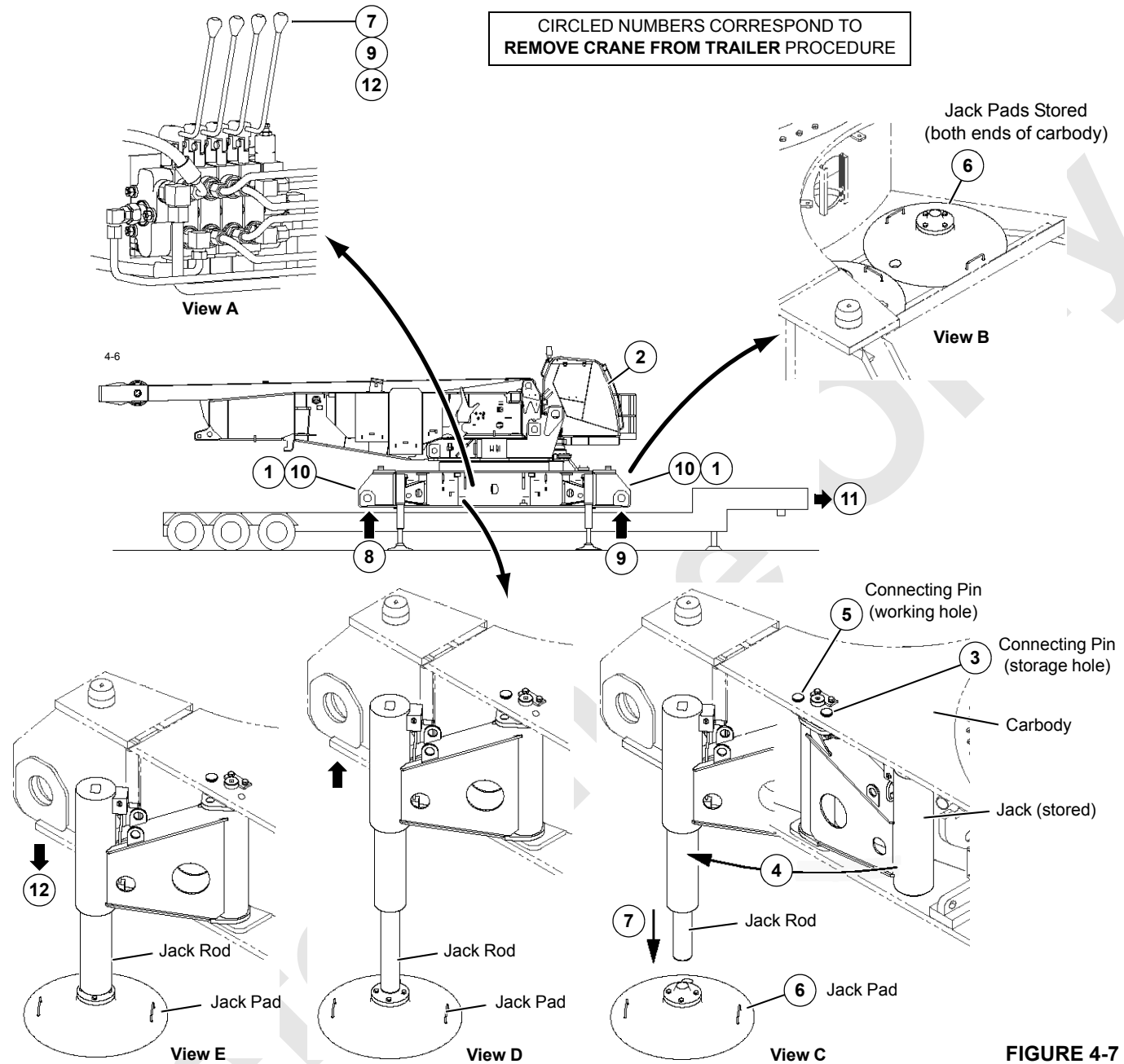

FIGURE 4-7

Remove Crane from Trailer

WARNING
Tipping Hazard!

Small diameter of jacking cylinders must be fully retracted before handling the first crawler, otherwise cylinders will be overloaded.

See [Figure 4-7](#) for the following procedure.

1. Untie crane from trailer.
2. Perform pre-start checks and start engine.

NOTE: It is normal for system fault alert and operating limit alert to come on when the engine is started.

The system fault alert should go off as engine oil pressure and hydraulic oil temperature rise to normal. If alert does not go off soon after start-up, determine fault, stop engine, and correct cause of fault (see Display Readings in Section 3).

3. Remove connecting pin from storage hole (View C).
4. Rotate jack out from storage position to working position (View C).
5. Install connecting pin in working hole (View C).
6. Remove jack pad from storage (View B) and place it on ground below jack rod (View C).

**WARNING****Moving Part Hazard!**

To avoid serious crushing injury — warn all personnel to stand clear of jacks.

Tipping Hazard!

Avoid tipping crane over — keep crane level while jacking.

NOTE: A 2-way level is provided near controls on front of carbody.

7. Extend jack rod (View C) with corresponding control on carbody (View A) until end of jack rod engages jack pad (View D).
 8. Repeat steps 3 - 7 for each jack.
 9. Using controls on front of carbody, extend carbody jacks fully to raise the crane off trailer. **Swinging is prohibited.**
 10. Remove blocking from between crane and trailer.
 11. Remove trailer. **Take extreme care not to hit jacks with trailer. Provide a signal person to give instructions to truck driver.**
 12. Retract jacks — keep the crane level — until carbody is approximately 22 to 25 in (559 to 635 mm) above ground and small diameter jack rod is fully retracted (View E).
- See [Figure 4-8](#) for the following procedure.
13. Rotate operator's cab to operating position:
 - a. Unpin cab strut from lug on adapter frame (View B).
 - b. Using cab raise/lower switch on remote control, raise cab to operating position (View A).
 - c. Rotate operator's cab 90° from shipping position.
 - d. Pin cab strut to lug on cab support (View A).
 - e. On top of cab (View A), move amber rotating beacon to operating (vertical) position and secure with screws provided. Install radio antenna.

4-7A

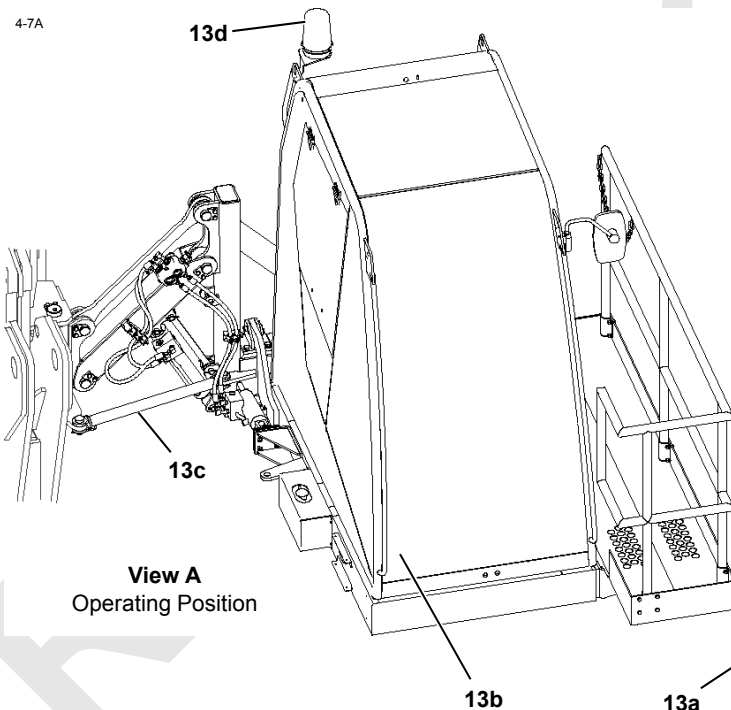

View A
Operating Position

4-7B

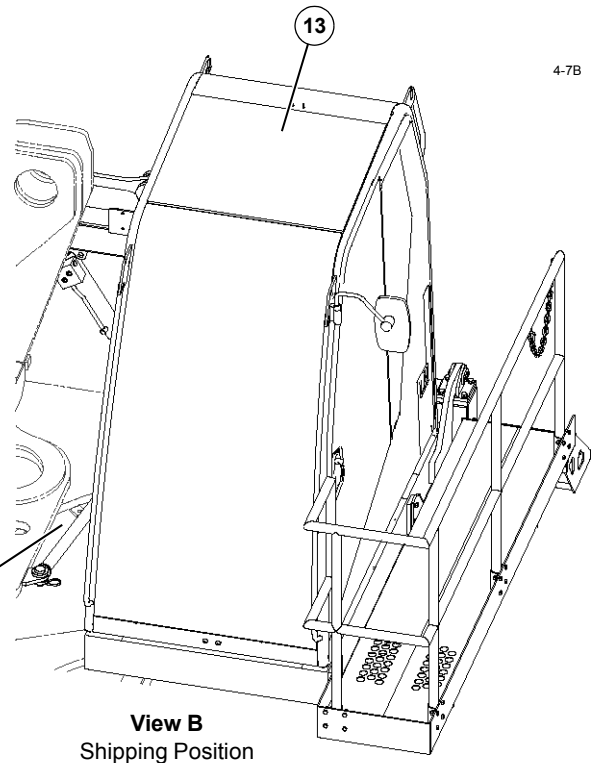

View B
Shipping Position

FIGURE 4-8

Item	Description
1	Live Mast
2	Mast Assist Arm and Cylinder
3	Boom Hoist
4	Boom Hoist Wire Rope

4-8

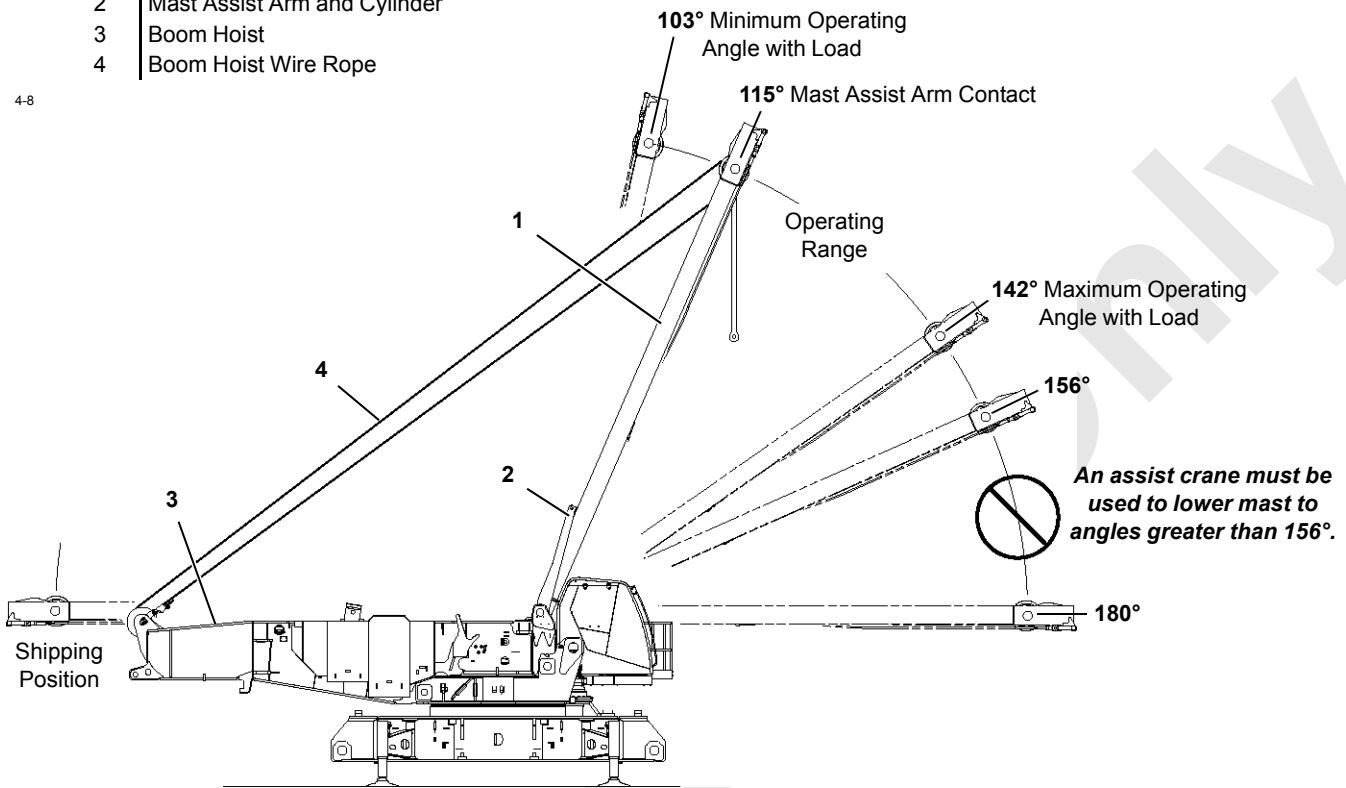

FIGURE 4-9

Raise Live Mast To Operating Position

See [Figure 4-9](#) for the following procedure.

The following controls are used to raise the mast. See Operating Controls in Section 3 for identification and operation of these controls.

- Go to rated capacity indicator/limiter configuration screen to select the Liftcrane Mast Capacities Chart.

The mast controls will not operate and the mast operating limits remain off until the Liftcrane Mast Capacities Chart is selected.

- MAST ARMS CONTROL raises and lowers the mast arms independently of the mast.
- BOOM HOIST CONTROL raises and lowers the mast while using mast as a boom.
- MAIN DISPLAY information screen monitors the mast operating angle and identifies mast faults.



WARNING

Falling Mast Hazard!

Prevent mast from falling over backwards or forward:

- Read and thoroughly understand mast raising instructions.
- Select Liftcrane Mast Capacities Chart in rated capacity indicator/limiter configuration screen before raising mast and using it as a boom. Mast operating limits remain off until this step is performed.

CAUTION

Mast Damage!

Make sure mast angle indicator is properly installed and calibrated prior to raising mast.

Mast can be damaged if angle indicator is not properly installed.

- Select Liftcrane Mast Capacities Chart.
- Monitor MAST ANGLE on main display information screen during raising procedure.
- Increase engine speed to desired RPM.
- Using mast switch on remote control, raise mast assist arms (2) until cylinders stall and stop.

NOTE: The following will occur if you don't do step 4 before step 5:

- Mast will not rise.
- Hazard warning buzzer will come on.

- Hazard warning symbol and MAST BELOW 2 DEGREES icon will appear on fault screen.

MAST 2 DEGREE
FAULT ICON

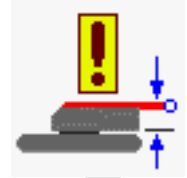

- BOOM DOWN with boom hoist control to raise live mast (1) to operating position.

Mast will rise as mast assist arm cylinders (2) extend automatically.

Mast assist arms will stop rising automatically when mast assist cylinders are fully extended (approximately 115°).

- Proceed to use mast as a boom with boom hoist control for remainder of self-erect assembly procedure.

See Liftcrane Mast Capacities Chart at the end of this section for detailed lifting capacities.

NOTE: The following will occur if the mast is lowered to 156°:

- Mast will stop lowering.
- Hazard warning buzzer will come on.
- Hazard warning symbol and MAST TOO FAR FORWARD icon will appear on fault screen.

MAST TOO FAR
FORWARD ICON

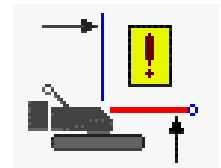

WARNING

Falling Mast Hazard!

Prevent mast from falling:

- Do not use limit bypass to lower mast below 156°. Mast will fall suddenly. **Connect an assist crane to end of live mast when it is necessary to lower it below 156°.**
- Do not lower mast assist arms until live mast is connected to boom rigging. Mast will fall over backwards if raised above 115° when arms are down.

4-9C
4-9D
A10740-18a
A10740-21

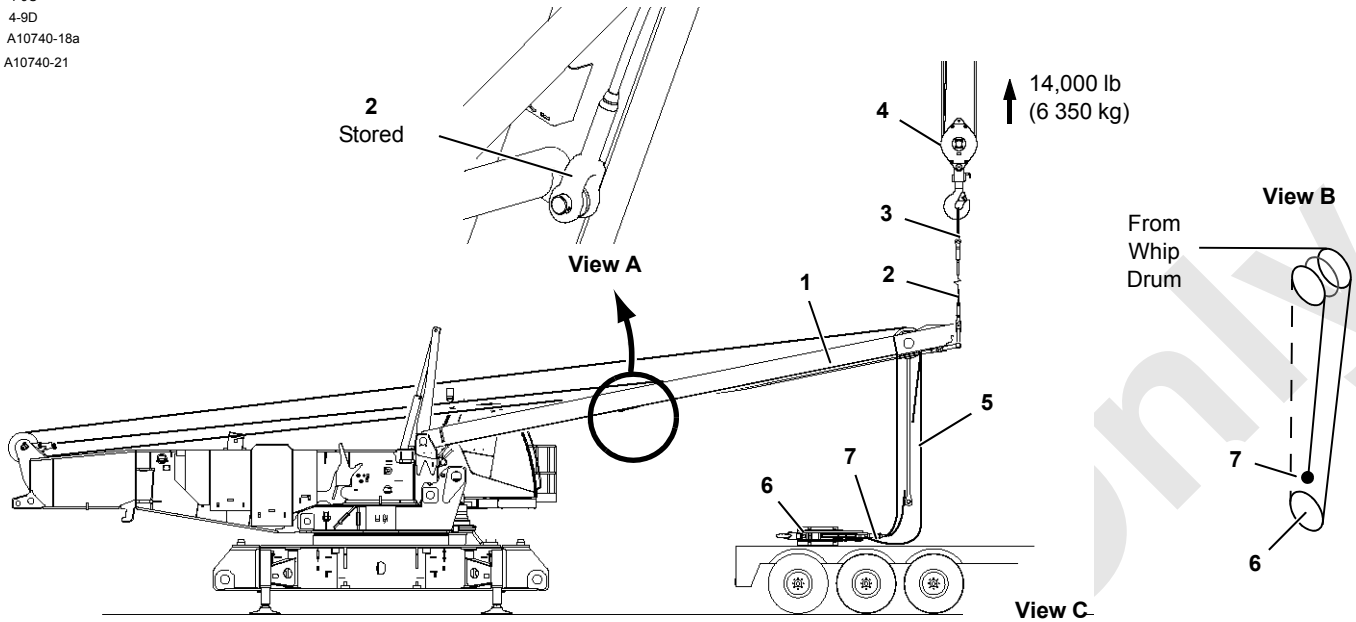

Component Identification

Item	Description
1	Live Mast
2	Handling Pendant
3	Owner-Furnished Nylon Slings
4	Assist Crane Load Block
5	Mast Straps
6	45 USt Load Block (41 t)
7	Button Socket
8	4-Leg Chain Sling

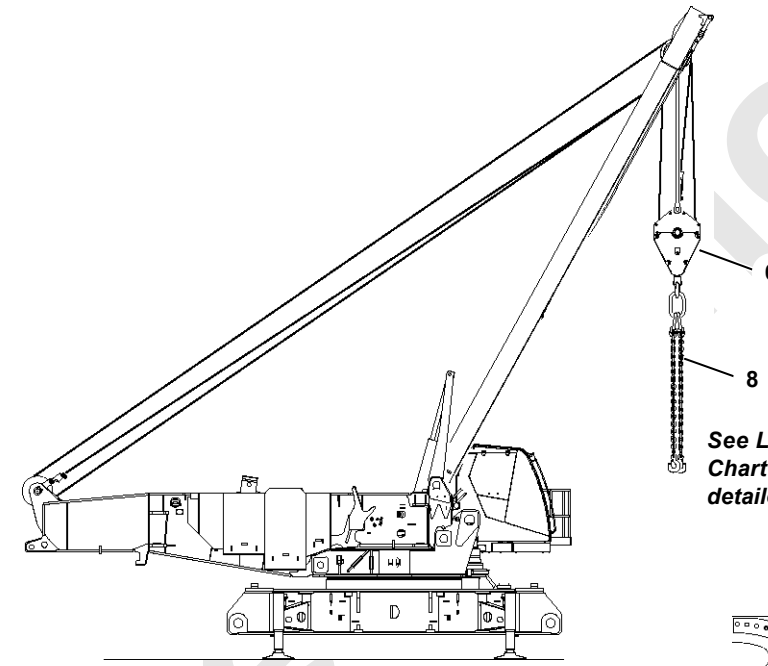

See *Liftcrane Mast Capacities Chart* at end of this section for detailed lifting capacities.

View D

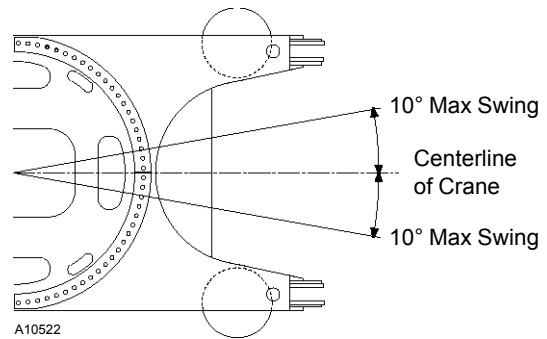

View E
While Handling First Crawler

FIGURE 4-10

Install Assembly Block

See [Figure 4-10](#) for the following procedure.



WARNING

Falling Mast Hazard!

Prevent mast from falling:

- Do not use limit bypass to lower mast below 156° until ***mast is supported with slings from assist crane.***
- Assist crane must lift 14,000 lb (6 350 kg).

1. Position trailer carrying assembly block (6) as shown in View C.
2. BOOM DOWN to lower mast (1) to approximately 160°.
3. Unpin handling pendants (2, View A) from mast and attach pendants to assist crane block (4) with nylon lifting slings (3).
4. Support mast with assist crane.
5. Lower mast to desired position with assist crane. Do not side load mast.

Use limit bypass switch to bypass mast limit and pay out boom hoist wire rope as mast is lowered with assist crane.



WARNING

Crush Hazard!

Do not stand or work under mast unless it is supported by assist crane.

CAUTION

Equipment Damage!

To prevent damage, guide mast straps (5) clear of trailer, as required.

6. Reeve wire rope from whip drum through sheaves in mast point and sheaves in assembly block (6, View B).
7. Anchor wire rope to button socket (7, View B) on load block (see [Wire Rope Installation](#)).
8. Connect 4-leg chain sling (8, View D) to assembly block.
9. Raise mast to at least 156° with assist crane. As mast is raised:
 - Pay out load line from whip drum.
 - Haul in wire rope on boom hoist.
10. Once mast is at or above 156°, support mast with boom hoist wire rope and disconnect handling pendants (2) from assist crane block.
11. Pin handling pendants to mast for storage (View A).
12. Haul in load line on whip hoist to lift assembly block off trailer.
13. Position mast in operating range (see [Figure 4-9](#)).

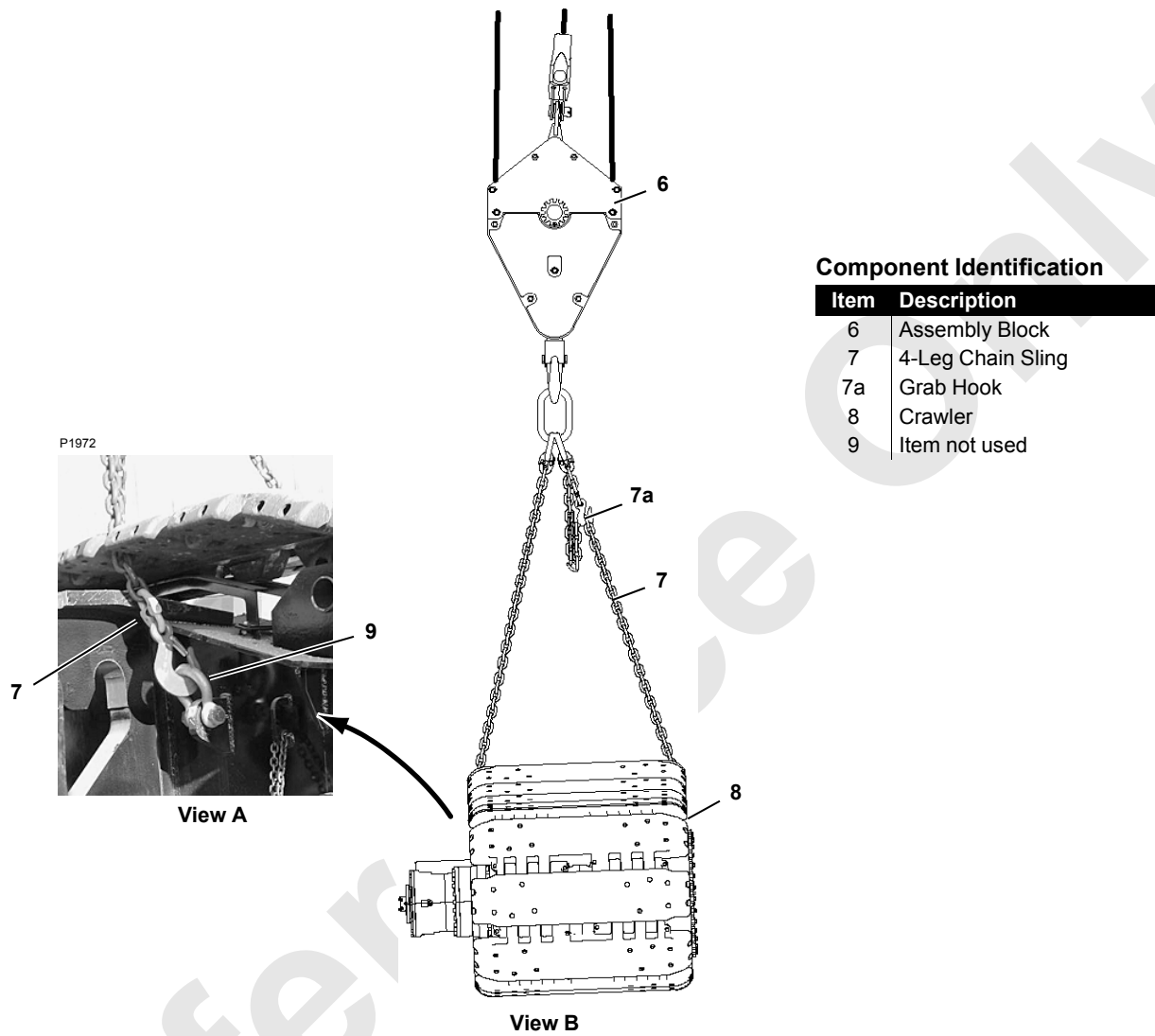

FIGURE 4-11

Handling Crawlers

See [Figure 4-11](#) for the following procedure.

1. Attach hooks from chain sling (7, View A and B) to four shackles (9) on crawler lifting lugs — two legs with grab hooks on outboard side.

2. Using grab hooks, shorten both outboard legs eleven chain links so crawler tips inward when lifted.
3. Position chains between crawler pads (View A).

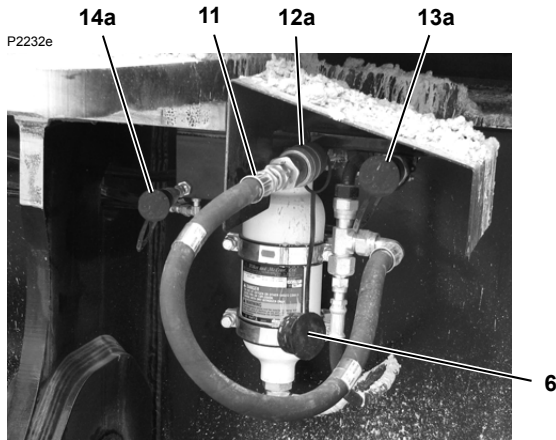

View A
CRAWLER SHIPPING ARRANGEMENT

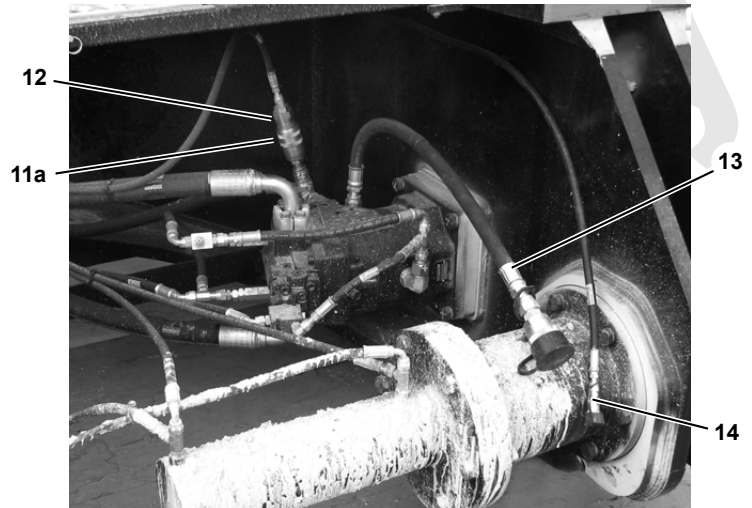

View B
CARBODY SHIPPING ARRANGEMENT

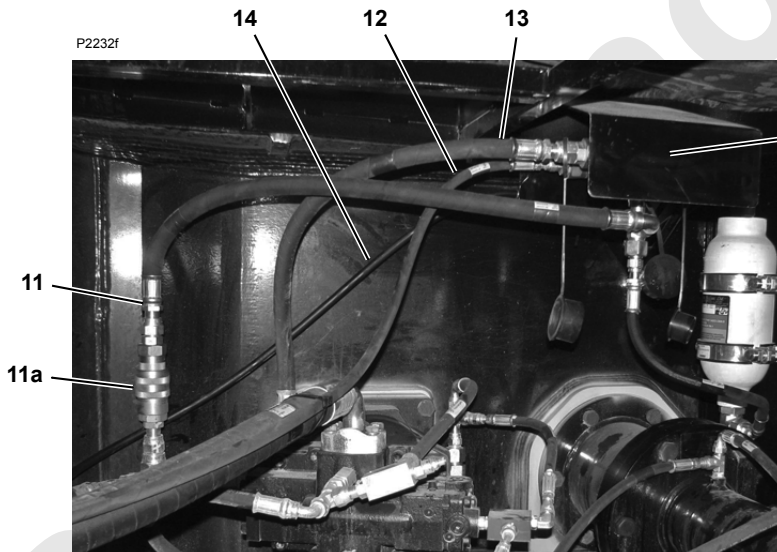

View C
CARBODY/CRAWLER WORKING ARRANGEMENT

12a and 13a
Under Guard

Component Identification

Item	Description
11	Hydraulic Hose
11a	Coupler
12	Hydraulic Hose
12a	Coupler
13	Hydraulic Hose
13a	Coupler
14	Grease Hose
14a	Coupler

FIGURE 4-12

4-10aa
4-10cc

See *Liftcrane Mast Capacities Chart* at end of this section for detailed lifting capacities.

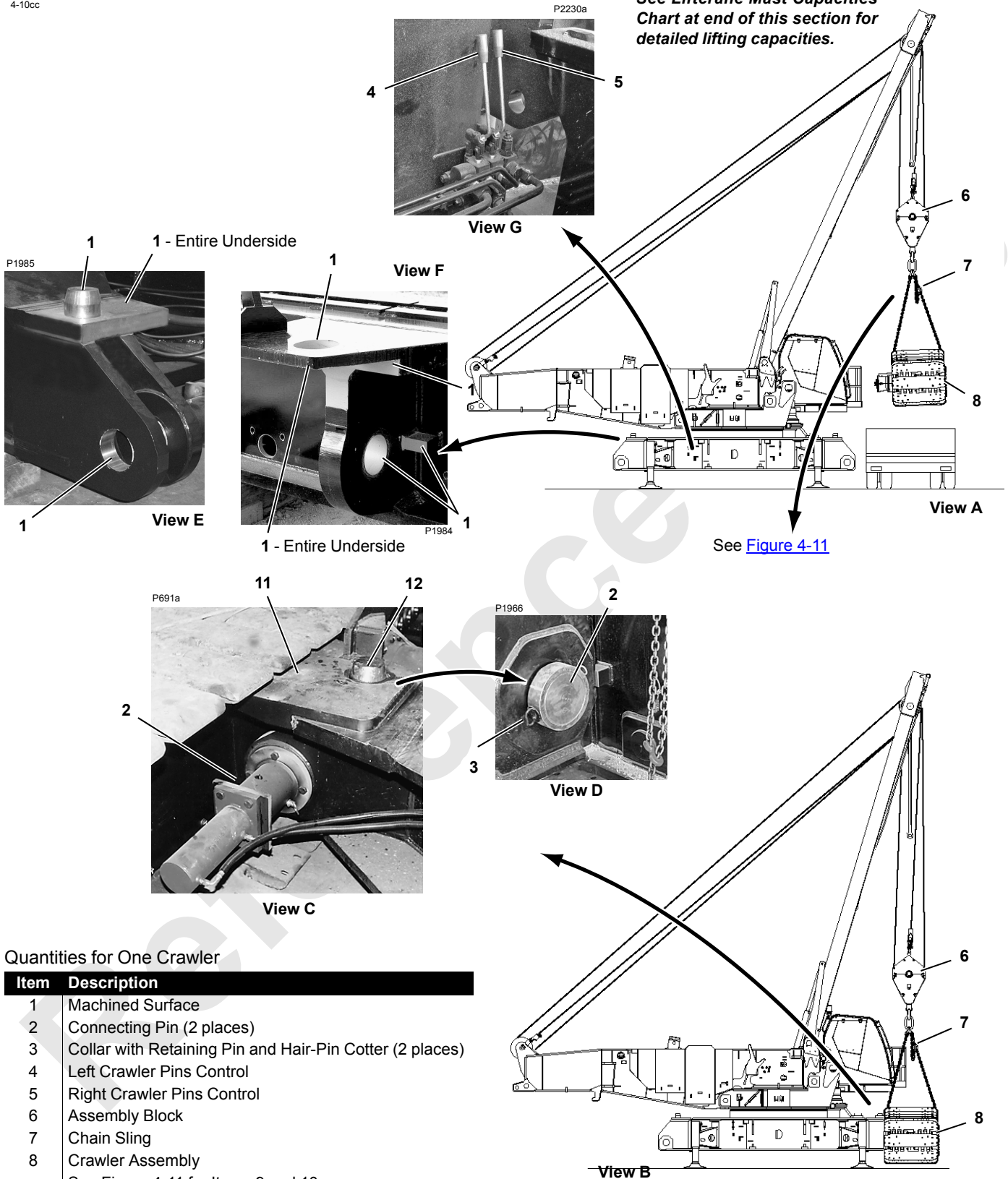

Quantities for One Crawler

Item	Description
1	Machined Surface
2	Connecting Pin (2 places)
3	Collar with Retaining Pin and Hair-Pin Cotter (2 places)
4	Left Crawler Pins Control
5	Right Crawler Pins Control
6	Assembly Block
7	Chain Sling
8	Crawler Assembly See Figure 4-11 for Items 9 and 10
11	Crawler Lug (2 places)
12	Fixed Pin (2 places)

FIGURE 4-13

Install Crawlers

The crane must be in the following configuration to install crawlers:

- Mast arms fully raised
- Liftcrane Mast Capacities Chart selected on rated capacity indicator/limiter display configuration screen
- Swing limited to 10° either side of center when handling first crawler ([Figure 4-10](#), View E)
- Mast operated within limits of Liftcrane Mast Capacities Chart at end of this section



WARNING

Tipping Hazard!

- Make sure the crane is level. Check 2-way level on front of carbody. Adjust carbody jacks as required.
- Do not exceed capacities given in Liftcrane Mast Capacities Chart when handling crawlers with mast. Crane will tip forward.

CAUTION

Parts Damage!

Avoid hitting carbody jacks with crawlers.

Install First Crawler

To prevent the crawler pads from sagging too much when the crawler is lifted, chains are installed between the crawler frames and pads (see [Figure 4-14](#), View F). Some sag must be allowed to prevent interference between carbody and crawler pads.

1. Thoroughly clean and grease all machined surfaces (1, [Figure 4-13](#), Views E and F) on carbody and crawler.

Failing to clean and grease machined surfaces may result in loud banging sounds when attempting to turn

crane while traveling. Though not harmful, operators may find the sounds disturbing.

Once the crawlers are installed, the drive shafts will be at opposite corners: drive shaft on left side to rear and drive shaft on right side to front.

2. Position trailer carrying crawler along desired side of crane (View A).
3. Disconnect hydraulic hoses (see [Figure 4-12](#)):
 - (11, View A) from coupler (12a)
 - (12, View B) from coupler (11a)

Move hoses out of the way so they do not interfere with crawler installation.

See [Figure 4-13](#) for the remaining steps.

4. Remove collars (3, View D) and retract crawler connecting pins (2) with crawler pins control (4 or 5, View G).

With crawler pins disengaged, grease them. See Section 5.

5. Attach hooks from chain sling (7, View A) to crawler as shown in [Figure 4-11](#).
6. Tilt operator's cab up, as required, so crawler does not hit cab.
7. Slowly hoist crawler clear of trailer.
8. Remove trailer.
9. Slowly lower crawler, mast up, and swing to engage holes in crawler lugs (11, View C) with fixed pins (12) in carbody.
10. Continue to lower crawler until handling chains slacken.
11. Using control handle (4 or 5, View G), engage crawler connecting pins (2, View D).
12. Install collars (3, View D) and retaining pins.
13. Unhook chain sling (7, View B) from crawler.

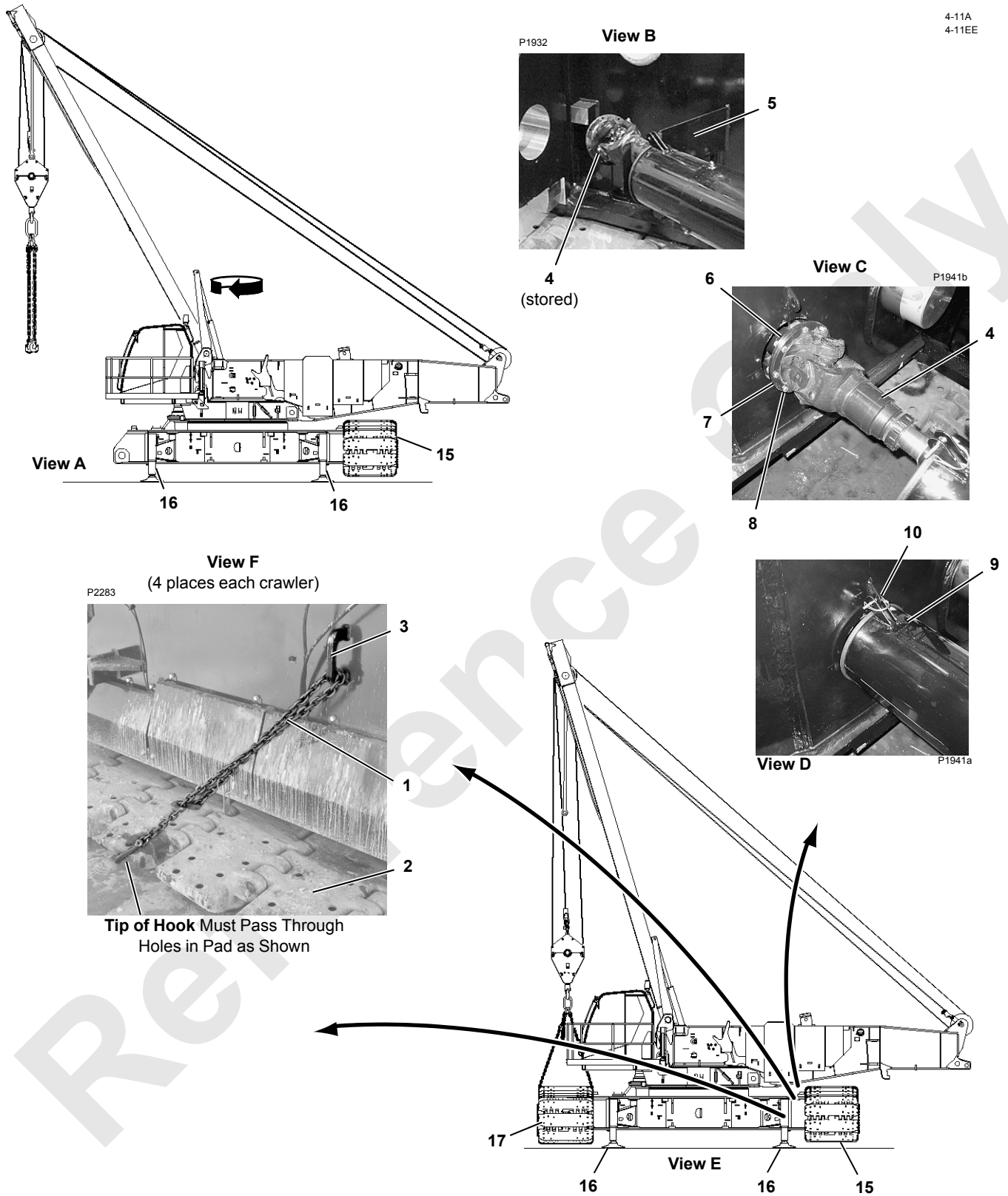

FIGURE 4-14

Legend for [Figure 4-14](#)

Item	Description	Item	Description
1	Chain with Hook	8	Flange Screw (8 each)
2	Crawler Pad	9	Drive Shaft Guard
3	Crawler Lug	10	Safety Pin
4	Crawler Drive Shaft	11-14	See Figure 4-12
5	Storage Bracket	15	Crawler Assembly (First Installed)
6	Drive Shaft Flange (Carbody)	16	Carbody Jacks
7	Drive Shaft Flange (Crawler)	17	Crawler Assembly (Second Installed)

Install First Crawler (continued)

14. Swing 180° (View A) to other side of crane before handling second crawler.



WARNING

Rotating Drive Shaft Hazard!

Crawler drive shaft rotates at high speed.

- Make sure crawler drive shaft is securely attached at both ends.
- Make sure guards are in place and securely attached at both ends during operation.
- Do not attempt to service drive shaft until the crane has been parked and engine stopped.

15. Lift crawler drive shaft (4, View B) off storage bracket (5), extend shaft, and align holes in drive shaft flanges (6 and 7, View C).

16. Apply Never-Seez™ or an equivalent anti-seizing compound to treads and under heads of flange screws (8, View C).

17. Insert flange screws (8) and torque to 75 ft-lb (102 N•m).

18. Slide drive shaft guard (9) over drive shaft and pin to carbody (View D).

19. Connect hydraulic hoses ([Figure 4-12](#), View C):

- (11) to coupler (11a)
- (12) to coupler (12a)
- (13) to coupler (13a)

20. Connect grease hose (14, [Figure 4-12](#), View C) to coupler (14a, View A).

Install Second Crawler

See [Figure 4-14](#) for the following procedure.



WARNING

Overload Hazard!

Swing crane 180° to opposite side before handling the second crawler. The second crawler cannot be lifted over the same side as the first crawler without **overloading** the jacks.

Tipping Hazard!

Do not allow assembly block to swing past inside edges of carbody jacks while installing second crawler. Crane will tip.

1. Repeat Install First Crawler steps 2 through 13 and 15 through 20 for second crawler.
2. Lower carbody until crawlers are on ground and then fully retract jacks.
3. Remove chains (1, View F) from between crawler pads (2) and crawler lugs (3) (four places each crawler). Store for future use.
4. Remove jack pads and store ([Figure 4-7](#), View C).
5. Position each carbody jack as follows:
 - a. Remove connecting pin ([Figure 4-7](#), View B).
 - b. Swing jacks in ([Figure 4-7](#), View A) and install connecting pin.

4-13A
A10786

Carbody Counterweight Identification

	Item	Description	Required Each End of Carbody	Weight Each lbs (kg)	Total Weight lbs (kg)
Series 1	No Carbody Counterweight				
Series 2	1	Center Box	1	30,000 (13 608)	60,000 (27 216)
Series 3	1	Center Box	1	30,000 (13 608)	120,000 (54 431)
	2	Side Box	2	15,000 (6 804)	

Legend

Item	Description
3	Lifting Lug (4 places each box)
4	Slot
5	Hook
6	Pin
7	Pin
8	Stairway (optional)
9	Pin (optional)

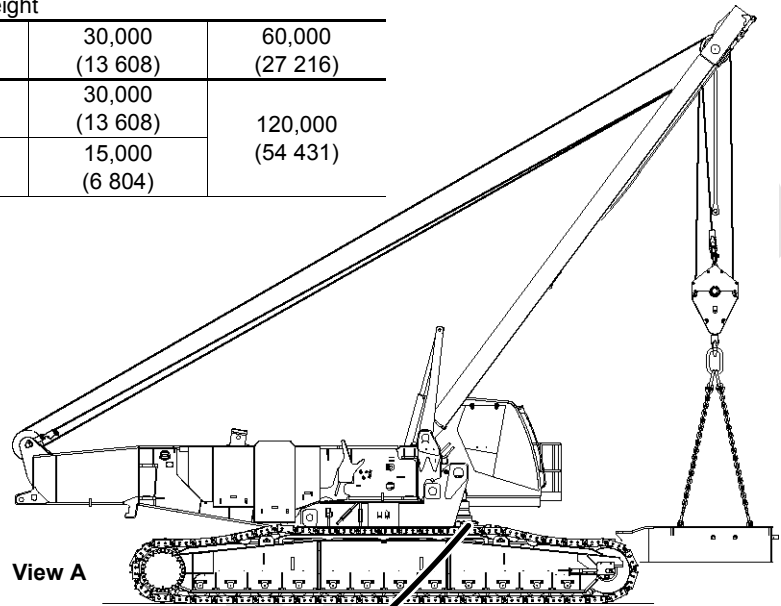

View A

See Liftcrane Mast Capacities Chart at end of this section for detailed lifting capacities.

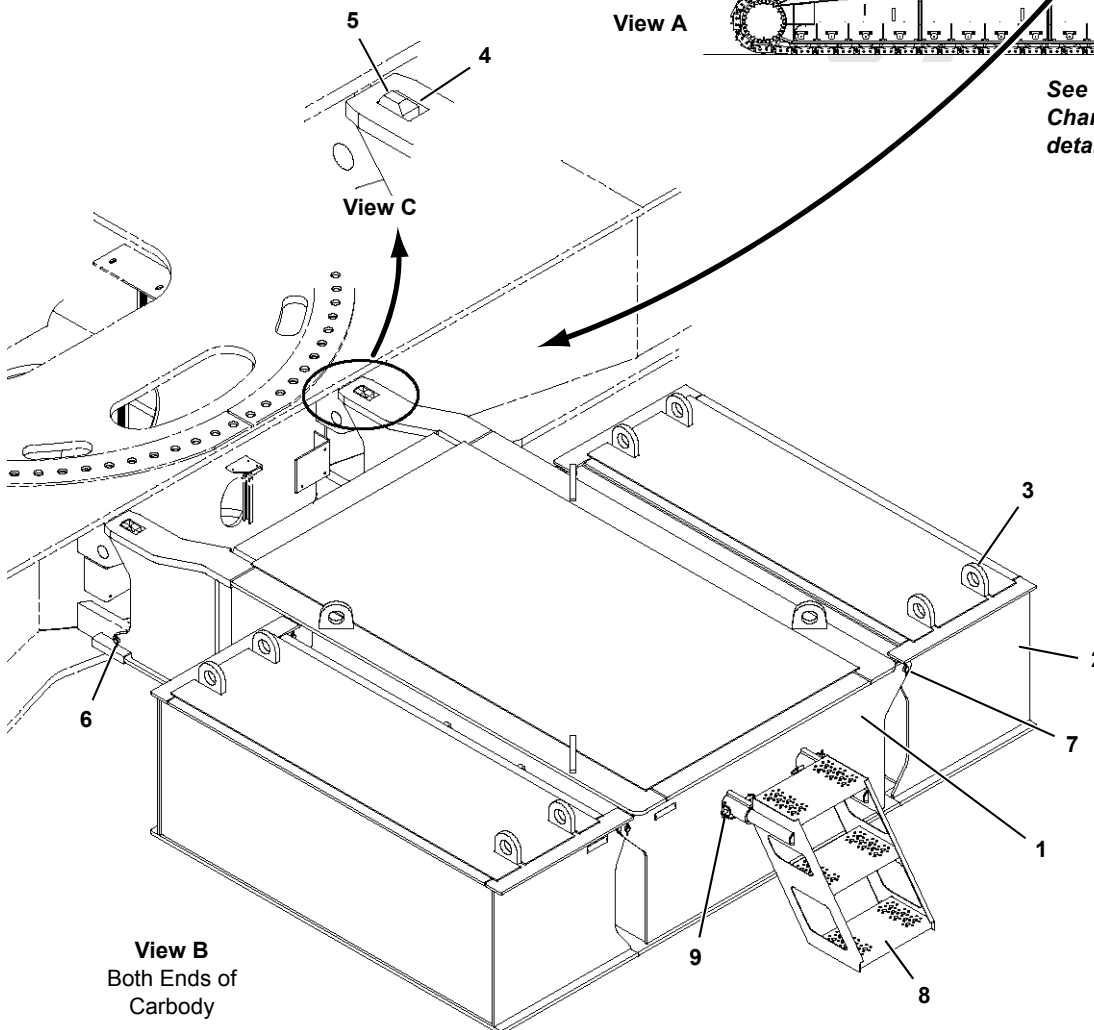

View B
Both Ends of Carbody

FIGURE 4-15

Install Counterweight

See [Figure 4-15](#) and [Figure 4-17](#) for identification of the counterweight used on the 16000 Series 1, 2, or 3.

Identification and installation of additional counterweight for the 16000 Series 4 and 5 are located in separate 16000 Wind Attachment manuals.



WARNING

Tipping Hazard!

To prevent the crane from tipping — install carbody counterweight before installing crane counterweight.

Install Carbody Counterweight

See [Figure 4-15](#) for the following procedure.

The carbody counterweight can be installed with the live mast. The crane must be in the following configuration to install the carbody counterweight:

- Mast assist arms fully raised. Mast will be at approximately 105° (assist arms supporting mast) when attaching carbody counterweights.
 - Liftcrane Mast Capacities Chart selected on RCL configuration screen
 - 360° swing permitted while handling counterweight
1. For **Series 2 and 3**, proceed as follows:
 - a. Attach crawler handling shackles to lifting lugs (3) on center box (1).
 - b. Attach legs of chain sling to shackles.
 - c. Lift center box into position at either end of carbody.
 - d. Boom, hoist, and swing as required to engage slots (4) in top of center box with hooks (5) on carbody as shown in View C.
 - e. Lower center box until bottom connecting holes line up.
 - f. Install pins (6, View B).
 - g. Disconnect chain sling and remove shackles.
 2. For **Series 3 only**, install each side box:
 - a. Attach crawler handling shackles to lifting lugs (3) on side box (2).
 - b. Attach legs of chain sling to shackles.
 - c. Lift side box (2) into position and pin to center box.
 - d. Disconnect chain sling and remove shackles.
 - e. Repeat steps for other side box.
 3. Repeat steps 1 and 2 at other end of carbody.
 4. Attach shackles to crawlers for storage.

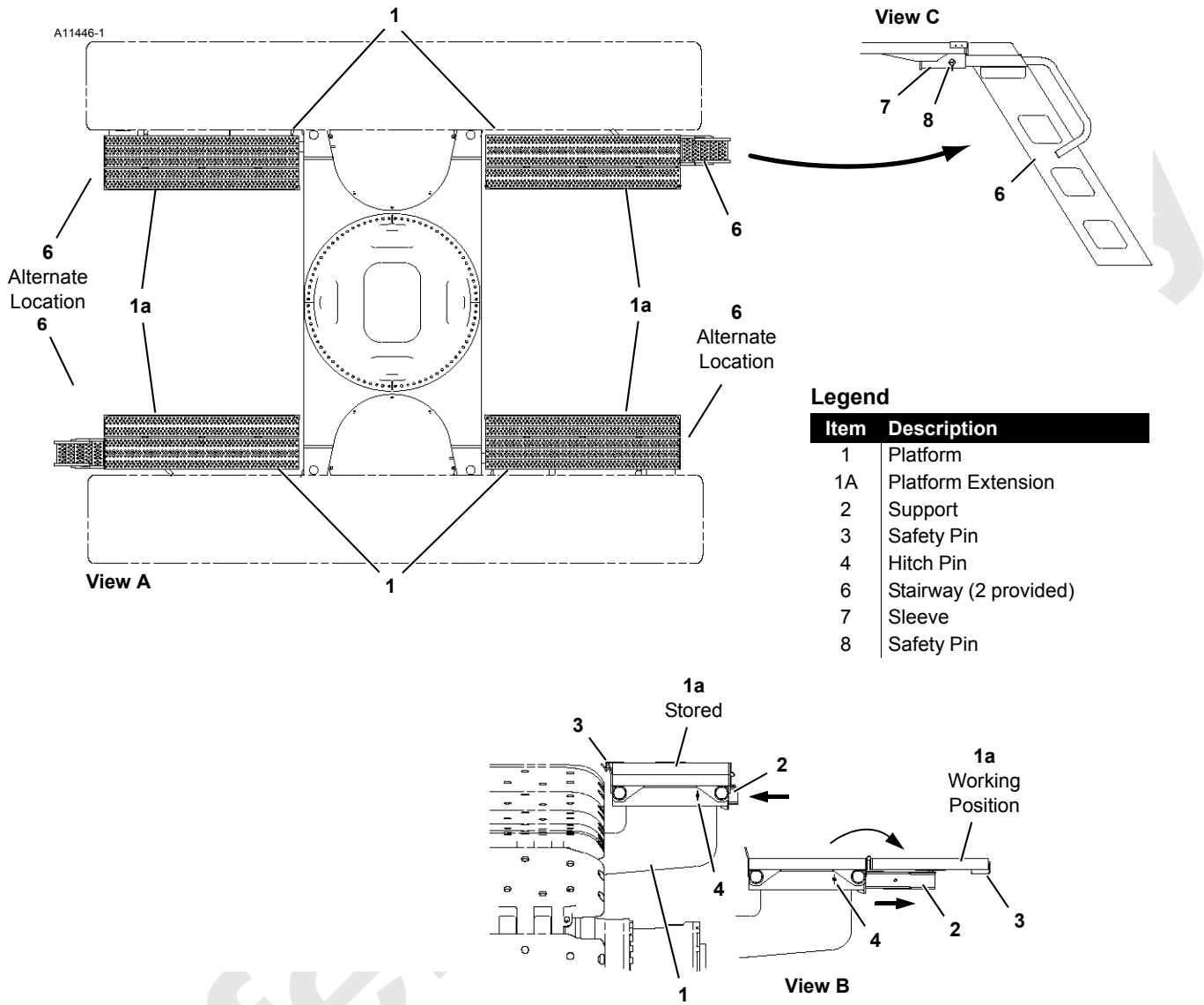

FIGURE 4-16

Install Crawler Platforms

See [Figure 4-16](#) for the following procedure.

The crawlers are equipped with platforms (1) as shown in View A.

Once the crawlers are installed, rotate platform extensions (1a, View b) to working position:

1. Remove hitch pins (4) and pull supports (2) out to working position.
2. Install hitch pins (4).
3. Remove safety pins (3) and rotate platform extensions (1a) to working position.
4. Install safety pins (3) in ends of platform extensions (1a).

Install Crawler Stairways

See [Figure 4-16](#) for the following procedure.

If the crawler stairways are not already installed, proceed as follows:

1. Using nylon slings from assembly block on live mast, lift stairway (6, View C) into position at desired corner of crawler platform (1).
2. Slide tubes at top of stairway through sleeves (7) on underside of platform.
3. Install quick-release pins (8) to lock stairway in place.
4. Repeat procedure for stairway at opposite corner.

NOTE: Stairways can be positioned at either end of either crawler to provide access that meets user needs.

A10787-2

Legend

Item	Description
3	Handling Pendant
4	Hydraulic Couplers
5	Hooks
6	Counterweight Pin
7	Hitch Pin
8	Adapter Plate
9	Lifting Sling (Owner Furnished)

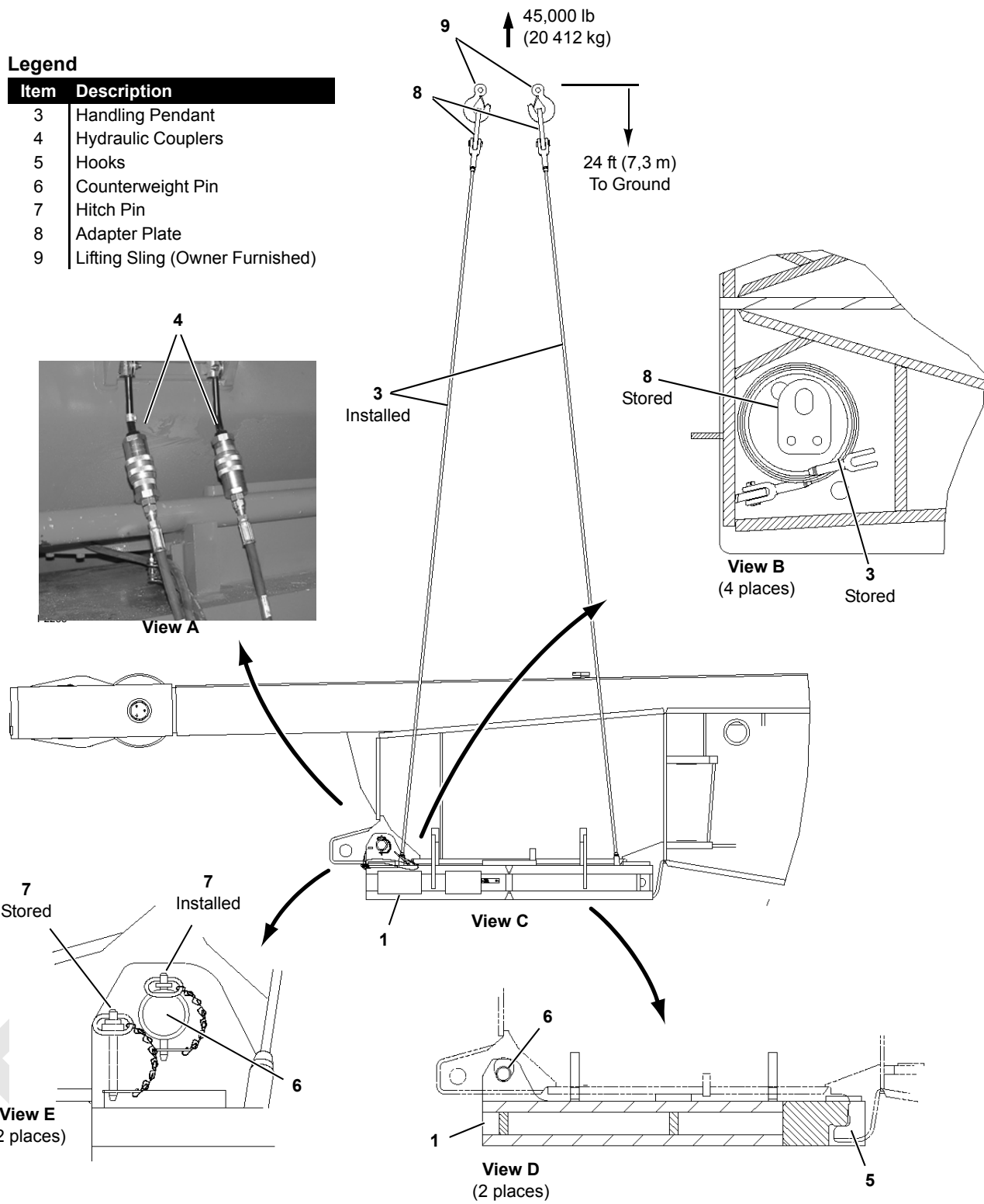

FIGURE 4-17

Install Crane Counterweight

The crane counterweight must be installed with an assist crane.

The mast can be fully lowered as shown [Figure 4-17](#) or forward of center as shown in [Figure 4-18](#).

See [Figure 4-17](#) for the following procedure.

1. Uncoil handling pendants (3, View B) with adapter plates (8, View B) from storage pockets in tray (1) and hook to lifting slings from assist crane (View C).

WARNING

Falling Load Hazard!

Pendants are designed to handle counterweight tray only. Do not attempt to lift tray with counterweight boxes installed. Pendants could break allowing counterweight tray and boxes to fall.

2. Lift counterweight tray into position at rear of crane and place tray on ground.
3. Connect hydraulic hoses from counterweight cylinders to couplers (4, View A) on rear of rotating bed.
4. Disengage counterweight pins (6) with switch on remote control. Pins will engage if switch is released.

5. Hoist, travel, boom, and swing as required with assist crane to guide counterweight tray into position under rear of rotating bed (View C).
6. Engage hooks (5, View D) in tray with hooks in rotating bed and align connecting holes.
7. Release switch on remote control to engage counterweight pins (6, View D).
8. Lower counterweight until it is supported by pins (pendants slacken).
9. Remove hitch pins (7, View E) from storage lugs and install in ends of counterweight pins (6).
10. Unhook handling pendants and adapter plates from lifting slings. Coil pendants and place adapter plates in storage pockets (View B).
11. Coil hydraulic hoses on tray for storage.
12. Do not disconnect hydraulic hoses from couplers on rotating bed. Due to thermal expansion, they could be difficult to reconnect.
13. Stack required counterweight side boxes (2, View F) one box at a time alternating from side to side.
 - First box each side must be centered on tray.
 - Lifting lugs and steps on each box center adjacent box
 - If your crane is luffing jib prepared, side box (2) with lugs (5) must be installed on top of each stack

Crane Counterweight Identification

	Item	Description	Total Required	Weight lbs (kg)	Total Weight lbs (kg)
Series 1	1	Tray	1	44,000 (19 958)	224,000 (101 605)
	2	Side Box	10	18,000 (8 165)	
Series 2	1	Tray	1	44,000 (19 958)	296,000 (134 265)
	2	Side Box	14	18,000 (8 165)	
Series 3	1	Tray	1	44,000 (19 958)	332,000 (150 595)
	2	Side Box	16	18,000 (8 165)	

Item	Description
3	Lifting Lug (4 each box)
4	Step (2 each box)
5	Lug (4 each top box)
6	Link (8, one top box)
7	Pin (4, one top box)

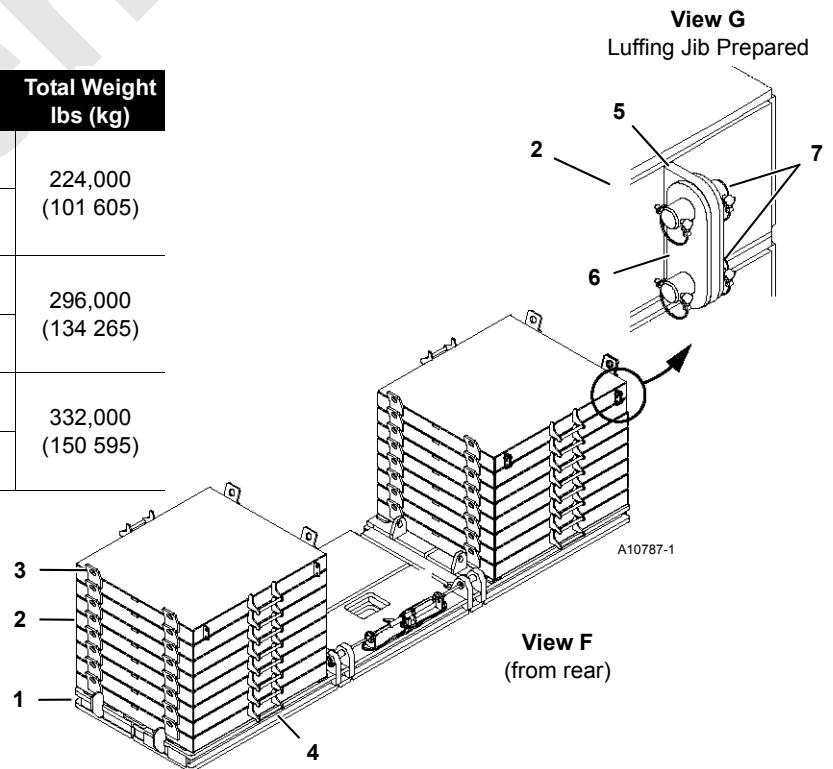

FIGURE 4-17 continued

A10787-1

Legend

Item	Description
1	Boom Butt
2	Wire Rope Guide
3	Lifting Lug
4	Pin with Cotter Pins
5a	Hoses
5b	Couplers in Boom Butt
5c	Couplers on Rotating Bed
6	Hinge Pin
7	Locking Pin
8	Shims

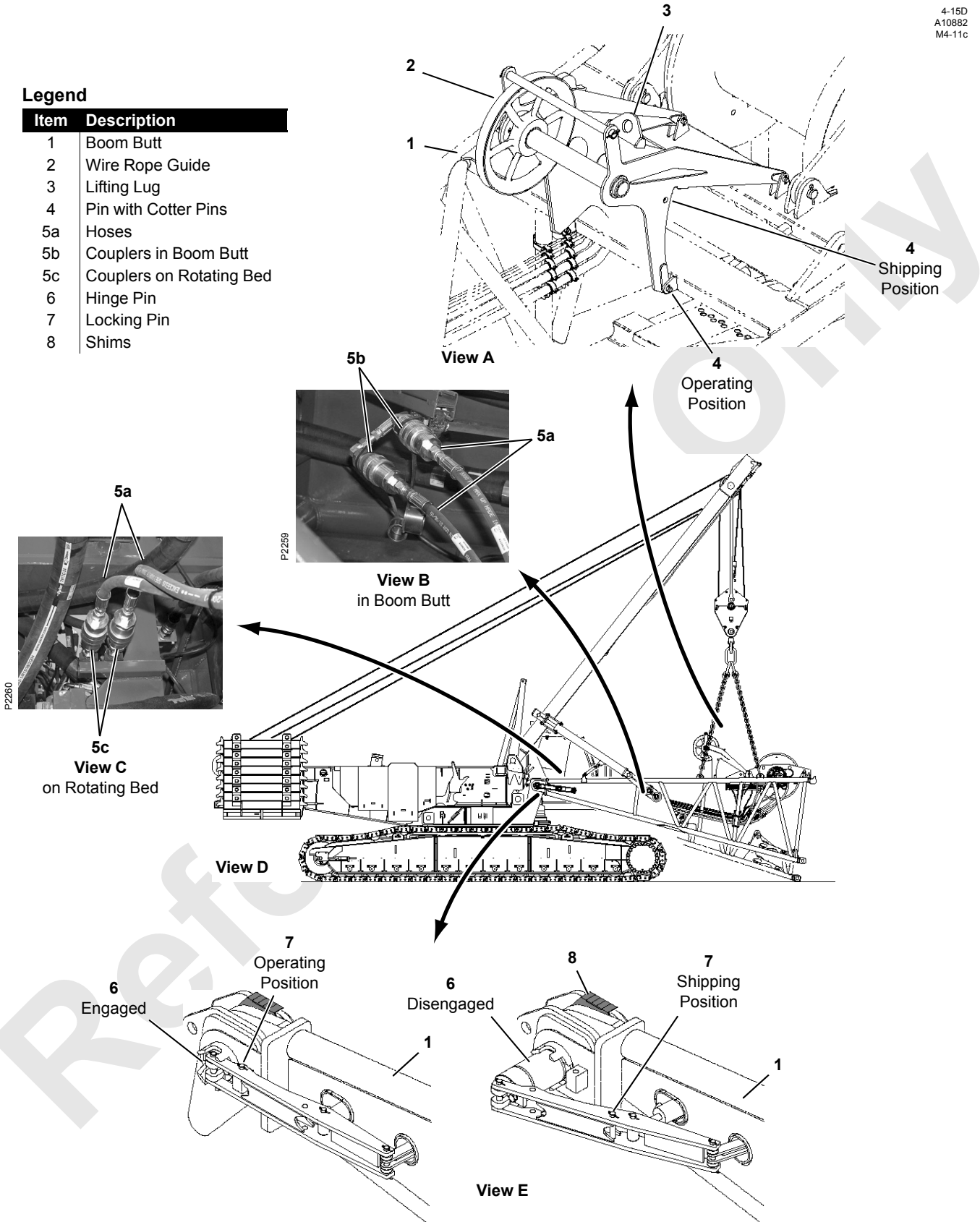

FIGURE 4-18

Assemble Boom

The boom can now be assembled using live mast.

See Boom Assembly later in this section for detailed instructions.

If a luffing jib will be installed, see separate instructions in Luffing Jib Operator Manual.

Install Boom Butt

See [Figure 4-18](#) for the following procedure.

1. Raise wire rope guide to operating position (View A):
 - a. Attach lifting sling to lifting lug (3, View A) on wire rope guide (2).
 - b. Support wire rope guide so pins (4) are loose and remove pins.
 - c. Raise wire rope guide from shipping position to operating position.
 - d. Install pins (4).
 - e. Disconnect lifting sling.
2. Attach lifting slings to lifting lugs in top chords of boom butt as shown in View D.

Adjust length of slings so butt is horizontal when lifted.

3. Lift butt into position at connecting holes in front of rotating bed (View D).
4. Disconnect hydraulic hoses (5a, View B) from couplers (5b) in boom butt.

Thoroughly clean couplers to prevent dirt from entering hydraulic system.

5. Connect hydraulic hoses (5a, View C) to couplers (5c) on left side of rotating bed.
6. Using setup remote control, disengage boom hinge pins (6, View F).
7. Position butt so connecting holes in butt line up with connecting holes in rotating bed.
8. Center butt between rotating bed lugs and check side play. If total side play is greater than 5/64 in (2 mm), install shims (8, View E) as follows:
 - a. Install thickest shim possible between inboard side of butt and rotating bed lug on both sides of crane.

Shim tabs must face inward and rest on rotating bed lugs.

- b. Install next thickest shim possible between inboard side of butt and first shim on both sides of crane.
 - c. If possible, install thinnest shim between inboard side of butt and second shim on both sides of crane.
9. Using setup remote control, engage boom hinge pins.
 10. Remove locking pins (7, View E) from shipping position and install in working position.
 11. Lower butt onto ground.
 12. Disconnect slings.
 13. Disconnect hydraulic hoses (5a, View C) from couplers (5c) on rotating bed and connect to couplers (5b, View B) in butt.

CAUTION

Boom Hinge Pin Damage!

Step [13](#) must be performed to relieve trapped pressure in boom hinge pin cylinders. Otherwise, damage to parts can occur.

14. Hold retaining bar (2, [Figure 4-19](#), View D) down and remove safety pin (3) from one end of bar.
15. Slowly raise retaining bar (2) and rotate hydraulic hoses forward.
16. Repin retaining bar for storage.
17. Remove dust covers from couplers on boom butt and from couplers and hydraulic hoses on rotating bed.

Thoroughly clean couplers to prevent dirt from entering hydraulic system.

18. Connect hydraulic hoses and couplers on rotating bed to couplers on boom butt as shown in [Figure 4-19](#).

NOTE: These are straight line connections. No hoses will cross when hoses are correctly connected.

On current production cranes, the hoses and couplers between the boom butt and rotating bed have numbered tags. To ensure proper connection, match the numbers on the tags.

Coupler-assist tool ([Figure 4-19](#), View A) can be used to connect the large couplers.

THIS PAGE INTENTIONALLY LEFT BLANK

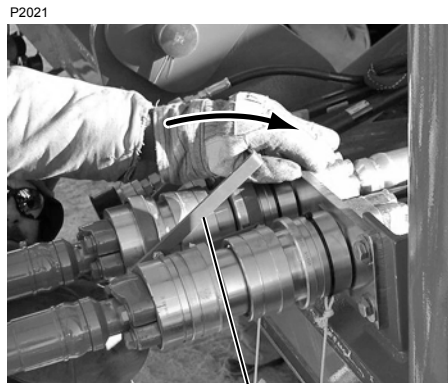

View A

Legend

Item	Description
1	Coupling Assist Tool
2	Retaining Bar
3	Safety Pin
4	Motor Pilot
5	Anti-Cavitation
6	High Pressure
7	Case Drain

Views B and C are from Crane Looking Forward

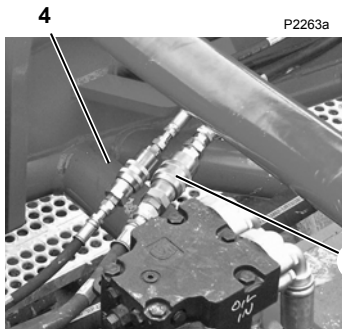

View B

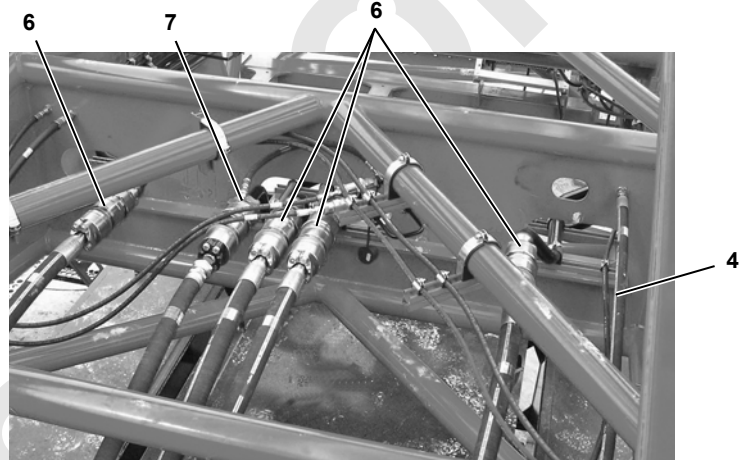

View C

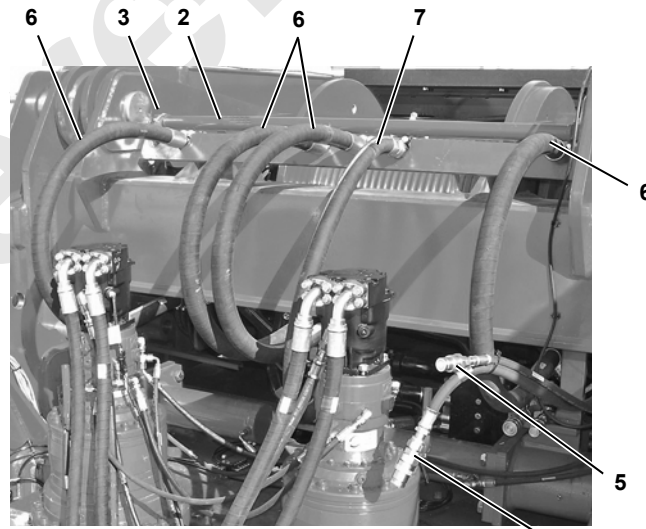

View D
From Front

4

FIGURE 4-19

4-17B
4-17C
4-17F

Legend

Item	Description
1	Trailer
2	Boom Butt
3	Mast
4	Chain Sling
5	Assembly Block
6	Handling Pendant
7	Assist Crane Load Block
8	Nylon Sling
9	Mast Strap
10	Hooked Connector
11	Fixed Pin
12	Pin with Safety Pin

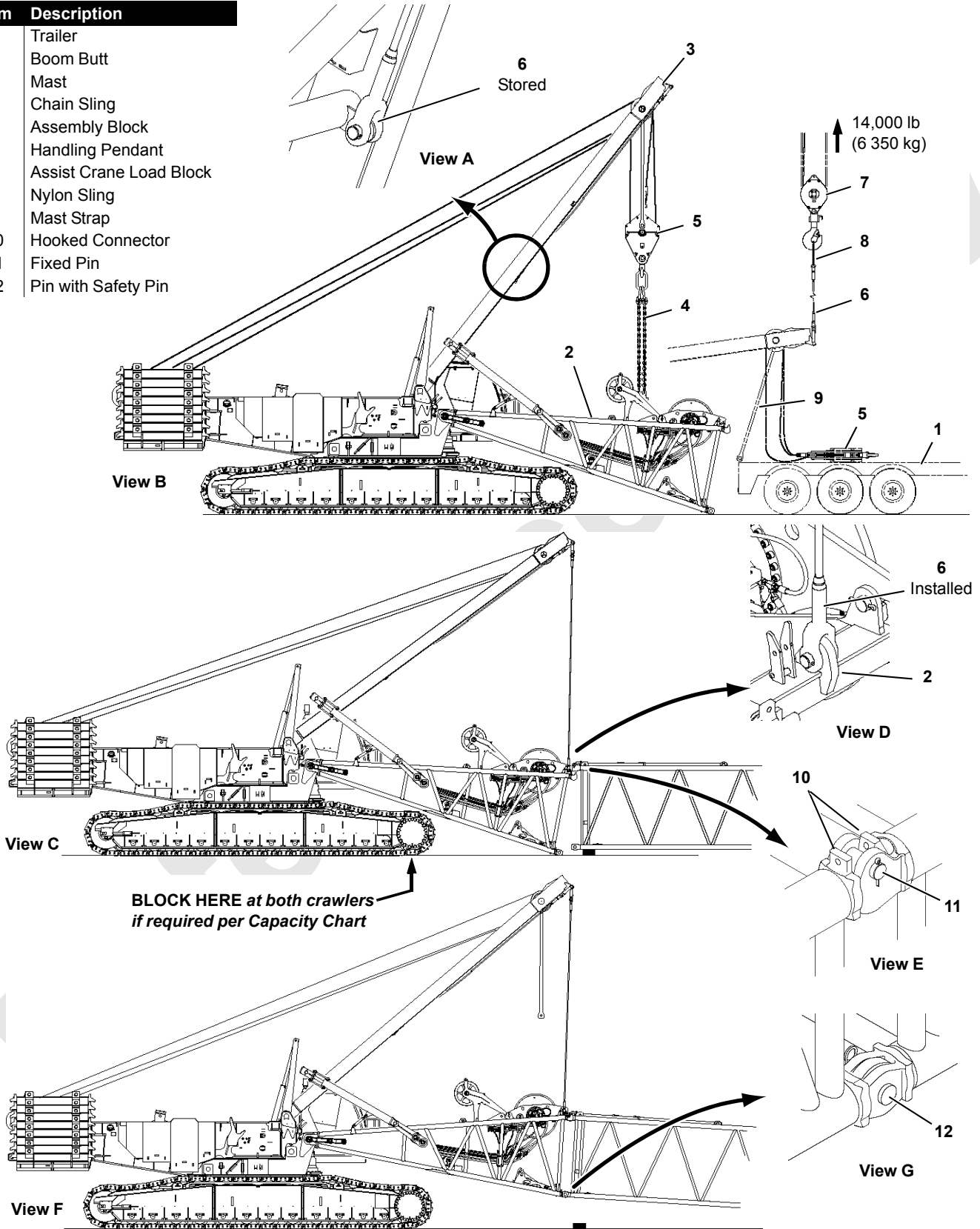

FIGURE 4-20

Remove Assembly Block

See [Figure 4-20](#) for the following procedure.



WARNING

Falling Mast Hazard!

Prevent mast from falling:

- Do not use limit bypass to lower mast below 156° until **mast is supported with slings from assist crane.**
- Assist crane must lift 14,000 lb (6 350 kg).

1. Position trailer (1, View B) or other means of transport in front of boom butt (2) as shown. Or, lower assembly block onto ground and remove with assist crane.
2. BOOM DOWN to lower mast (3) to approximately 150°.
3. Guide slings (4) and assembly block (5) around end of boom butt as mast is lowered.
4. Unpin handling pendants (6, View A) from mast and attach pendants to assist crane block (7) with nylon lifting slings (8).
5. Support mast with assist crane.
6. Lower mast to desired position with assist crane. Do not side load mast.

Use limit bypass switch to bypass mast limit and pay out boom hoist wire rope as mast is lowered with assist crane.



WARNING

Crush Hazard!

Do not stand or work under mast unless it is supported by assist crane.

7. Lower assembly block (5, View B) onto trailer or ground. Guide mast straps clear of trailer, as required.
8. Remove wire rope from assembly block and mast and store wire rope on whip drum.

CAUTION

Lacing Damage!

Take necessary precaution while storing wire rope on drum so button end of rope does not fall and damage lacings in boom butt.

9. Raise mast to at least 150° with assist crane. As mast is raised haul in wire rope on boom hoist.
10. Once mast is at or above 150°, support mast with boom hoist wire rope and disconnect handling pendants (6) from assist crane block.
11. Position mast at approximately 140° (View C).

Connect Boom Butt to Boom

See [Figure 4-20](#) for the following procedure.

1. Pin handling pendants (6, View D) to lugs on boom butt (2).
2. Boom up to lift boom butt just clear of ground.
3. Position the crane so boom butt is in line with end of boom (View C).
4. Travel forward and boom down to align hooked connectors (10, View E) in boom butt with fixed pins (11) in adjacent insert.
5. See Capacity Chart to determine if crawlers must be blocked to raise assembled length of boom. **If blocking is required:**
 - a. Mark ground at front end of crawler — center of tumbler on one crawler and center of front roller on other crawler.
 - b. Disengage boom butt from insert and travel backwards approximately 4 ft (1,2 m).
 - c. Install required blocking at points marked in step 5a.
 - d. Repeat step 4.



WARNING

Falling Boom Hazard

Do not attempt to lift assembled boom with handling pendants. Handling pendants could break allowing boom to fall.

6. Boom up slowly (View F) until bottom connectors are lined up between butt and insert.
7. Install pins (12, View G).
8. Unpin handling pendants (6, View D) from boom butt and pin to mast (View A) for storage.

Legend

Item	Description
1a	Mast Strap
1b	Insert Strap
2	Links
3	Pin (shipping)
4	Link (shipping)
5	Pin, with Collar, Retaining Pin, and Cotter Pins
6	Terminator Plug with Sealing Cap
7	Electric Cable on Crane
8	Electric Cable From Boom
9	Electric Cable from Drum 1 on Boom
10	Electric Cable from Drum 3 on Boom

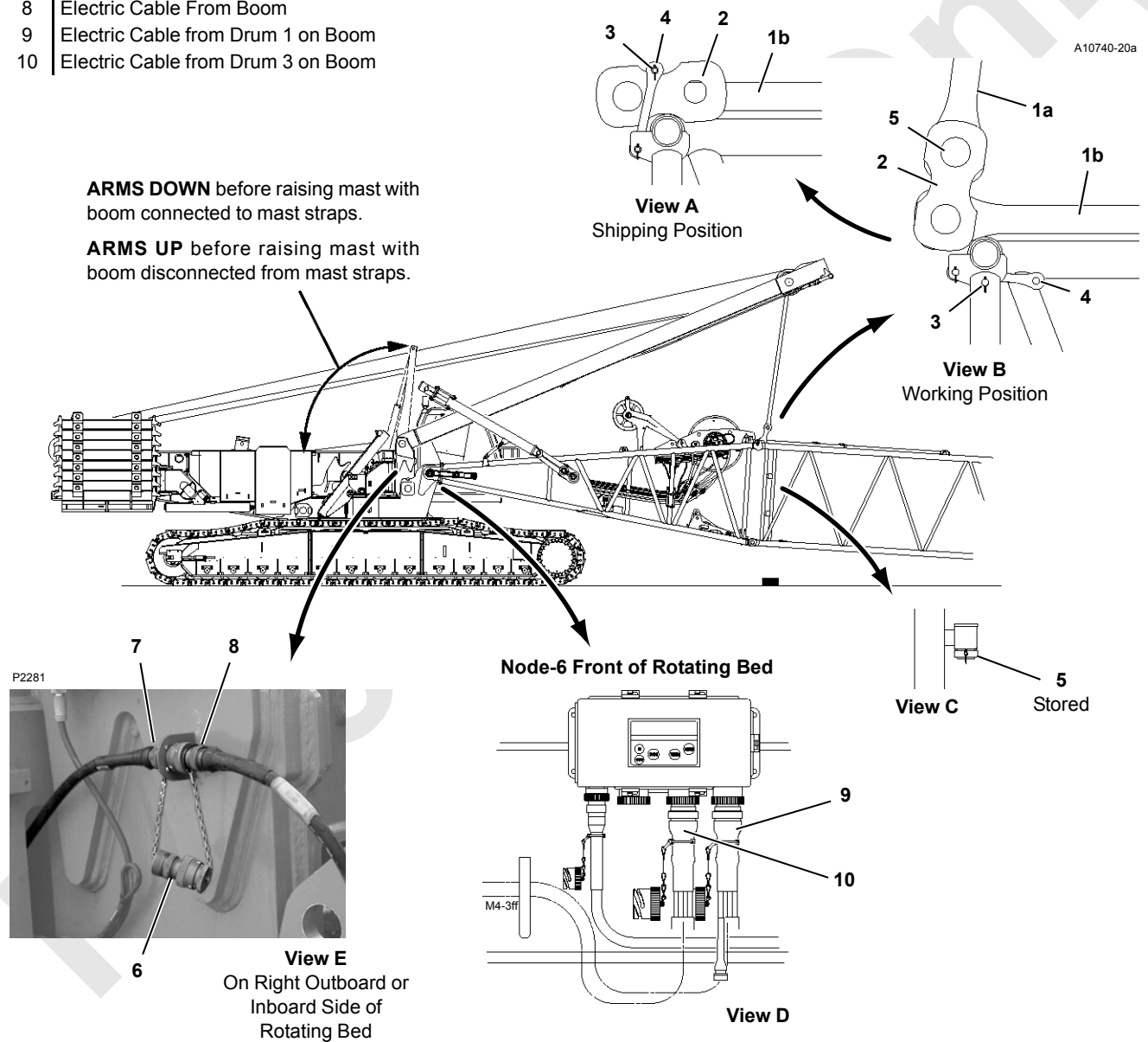

FIGURE 4-21

See [Figure 4-21](#) for the remaining steps.

9. Connect electric cable from crane to controller on boom butt:
 - a. Remove terminator plug (6, View E) from electric cable (3) on crane.
 - b. Connect electric cable (8) from boom butt to cable (3).
 10. Connect electric cables (9, View D) and (10 optional) from boom butt to node on front of rotating bed.
- NOTE:** For Node-6 electrical connections with Mast Stop Limit Switch, reference [Figure 4-22](#) for cranes with software version M002066 or newer.
11. Lower mast until ends of mast straps (1a) are approximately 18 in (457 mm) from boom.
 12. Connect mast straps (1a, View B) to insert straps (1b), as follows:
 - a. Remove pins (3, View A) and rotate links (4) to working position (View B).
 - b. Pin links (4, View B) in working position.

- c. Remove pins (5, View C) from storage.
- d. Rotate links (2, View A) up and pin to mast straps (1a) with pins (5, View B). Lower mast as required to align holes.



DANGER

Falling Mast/Boom Hazard!

Prevent mast and boom from falling:

- Fully lower mast arms before raising boom. *Mast can buckle and collapse if it contacts mast arms with a fully rigged boom.*
-
13. Fully lower mast arms using switch on remote control.
 14. Turn off and store setup remote control.
 15. Select proper capacity chart on configuration screen of RCL display.
 16. Boom can now be raised. **Perform Pre-Raising Checks.**

Node-6 Electrical Connections For MAX-ER With Mast Stop Limit Switch

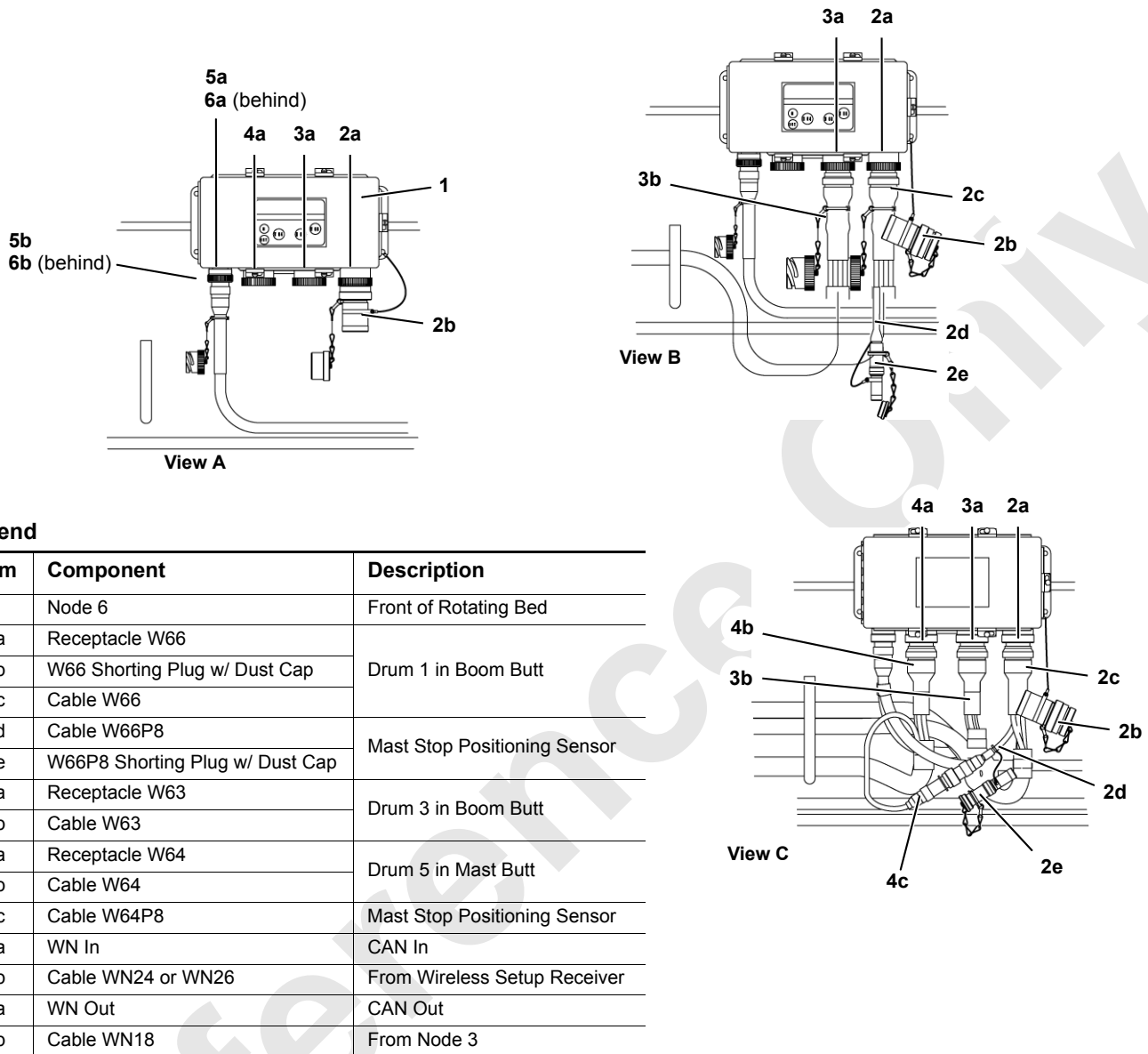

FIGURE 4-22

NODE-6 CONFIGURATION WITH MAST STOP LIMIT SWITCH

See [Figure 4-22](#) for the following procedure.

NOTE: The following Node-6 configurations only apply to MAX-ER® attachments with mast stop limit switch and crane software version M002066 or newer.

Shipping Configuration (View A)

1. Connect terminating plug (2b, View A) to Node-6 receptacle (2a).

Check the crane display to verify mast stop cylinder position sensor information screen is no longer available.

Working Configuration with Boom (View B)

1. Disconnect terminating plug (2b, View A) from receptacle (2a). Connect the sealing cap to the end of the terminating plug and let the terminating plug hang freely.
2. Connect electric cable (2c, View B) from the boom butt to receptacle (2a).
3. Connect terminating plug (2e, View B) to electric cable (2d).
4. If equipped with a luffing hoist, connect electric cable (3b, View B) to receptacle (3a).

Working Configuration with MAX-ER® (View C)

1. Disconnect terminating plug (2b, View A) from receptacle (2a). Connect the sealing cap to the end of the terminating plug and let the terminating plug hang freely.
2. Connect electric cable (2c, View B) from the boom butt to receptacle (2a).
3. Connect terminating plug (2e, View B) to electric cable (2d).
4. If equipped with a luffing hoist, connect electric cable (3b, View B) to receptacle (3a).
5. Disconnect terminating plug (2e, View B) from electric cable (2d). Connect the sealing cap to the end of the terminating plug and let the terminating plug hang freely.
6. Connect electric cable (4b, View C) from the mast butt to receptacle (4a).
7. Connect electric cable (2d, View C) to electric cable (4c).

CRANE DISASSEMBLY

Lower Boom

Perform steps 1 through 4 under Boom Removal topic to lower the boom and jib (if equipped).

Disconnect Boom Butt from Boom

1. Disconnect boom wiring:
 - a. Disconnect electric cable (8, [Figure 4-21](#), View E) (from boom) from electric cable (7) on crane.
 - b. Remove sealing cap and connect terminator plug (6, View E) to electric cable (7). Also see [Figure 4-5](#), View D.
 - c. Connect sealing cap to electric cable (8) and store electric cable (8) on boom butt.
 - d. Disconnect electric cables (9, [Figure 4-21](#), View D) and (10 optional) from node on front of rotating bed.

- e. Connect sealing caps to electric cables (9 and 10) and store the cables in the boom butt.
 - f. Disconnect electric cable from cable reel in butt at controller on boom butt and at controller on boom top.
 - g. Coil cable onto cable reel.
2. Disconnect mast straps from boom (see [Figure 4-21](#)):
 - a. Lower mast until straps (1b) for insert next to butt are resting on insert as shown in View B.
 - b. Unpin links (2, View B) from mast straps (1a) and store links (2) and straps (1b) as shown in View A.
 - c. Store pins (5) in pockets on insert (View C).
 3. Fully raise mast arms using switch on remote control.



DANGER

Falling Mast/Boom Hazard!

Prevent mast from falling:

- Fully raise mast arms before raising mast. Mast will fall over backwards if raised to vertical when arms are down.

4. Disconnect boom butt:

See [Figure 4-20](#) for the following procedure.



DANGER

Falling Boom Hazard

Do not remove bottom pins between butt and insert until handling pendants are connected and supporting boom. Boom will collapse.

- a. Unpin handling pendants (6, View A) from mast and pin to lugs on boom butt (View D).
- b. Boom up until handling pendants (6, View F) are just taut.



WARNING

Falling Boom Hazard

Do not attempt to lift assembled boom with handling pendants. Handling pendants could break allowing boom to fall.

- c. Remove pins (12, View G).

- d. Slowly boom down to lower boom onto blocking at least 6 in (152 mm) (View C).
 - e. Boom down until hooked connectors (10, View E) in boom butt disengage fixed pins (11) in adjacent insert.
 - f. Travel backward until crane is clear of boom and there is enough room to install assembly block.
 - g. Lower boom butt onto blocking.
 - h. Unpin handling pendants (6, View D) from boom butt.
6. Reeve wire rope from whip drum through sheaves in mast point and sheaves in assembly block (see [Figure 4-10](#), View B).
 7. Anchor wire rope to socket and wedge on load block (see [Wire Rope Installation](#)).
 8. Connect 4-leg chain sling (4) to assembly block.
 9. Raise mast to at least 156° with assist crane. As mast is raised:
 - Pay out load line from whip drum.
 - Haul in wire rope on boom hoist.

Install Assembly Block

See [Figure 4-20](#) for the following procedure.



WARNING Falling Mast Hazard!

Prevent mast from falling:

- Do not use limit bypass to lower mast below 156° until ***mast is supported with slings from assist crane.***

1. Position trailer carrying assembly block (5) at end of boom butt as shown in View B.
2. BOOM DOWN to lower mast (3) to approximately 160°.
3. Pin handling pendants (6) to assist crane block (7) with nylon lifting slings (8).
4. Support mast with assist crane.
5. Lower mast to desired position with assist crane. Do not side load mast.

Use limit bypass switch to bypass mast limit and pay out boom hoist wire rope as mast is lowered with assist crane.



WARNING Crush Hazard!

Do not stand or work under mast unless it is supported by assist crane.

CAUTION Equipment Damage!

To prevent damage, guide mast straps (9) clear of trailer, as required.

10. Once mast is at or above 156°, support mast with boom hoist wire rope and disconnect handling pendants (6) from assist crane block.
11. Pin handling pendants to mast for storage (View A).
12. Haul in load line on whip hoist to lift assembly block off trailer. ***Take every precaution to prevent block from swinging into end of boom butt and causing damage.***
13. Position mast in operating range (see [Figure 4-9](#)).

Remove Boom Butt

See [Figure 4-18](#) for the following procedure.

1. Lower wire rope guide to shipping position (View A):
 - a. Attach lifting sling from assembly block to lifting lug (3, View A) on wire rope guide (2).
 - b. Support wire rope guide so pins (4) are loose and remove pins.
 - c. Lower wire rope guide from operating position to shipping position.
 - d. Install pins (4).
 - e. Disconnect lifting sling.
2. Disconnect hydraulic hoses between boom butt and rotating bed (see [Figure 4-19](#)):
 - a. ***Thoroughly clean each coupler*** and connect dust covers to couplers to prevent dirt accumulation.
 - b. Unpin and move retaining bar (2) out of way.
 - c. Swing hydraulic hoses (6 and 7) rearward into notches on rotating bed (View D).
 - d. Pin retaining bar in position to retain hoses (View D).
3. Attach lifting slings from assembly block to lifting lugs in top chords of boom butt as shown in [Figure 4-18](#), View D.

4. Disconnect hydraulic hoses (5a, View B) from couplers (5b) in boom butt.

Thoroughly clean couplers to prevent dirt from entering hydraulic system.

5. Connect hydraulic hoses (5a, View C) to couplers (5c) on left side of rotating bed.
6. Remove locking pins (7, View E) from operating position and install in shipping position.
7. Attach hand-held taglines to butt so it can be stabilized when pins are disconnected.
8. Lift butt clear of ground (View D).



WARNING

Moving Load Hazard!

Warn personnel to stand well clear of boom butt. Butt may swing out away from crane when pins are disengaged.

9. Using setup remote control, disengage boom hinge pins (6, View E, [Figure 4-18](#)).
10. Stabilize butt with taglines and pull boom butt clear of rotating bed.
11. Using setup remote control, engage boom hinge pins (6, View E).
12. Disconnect hydraulic hoses (5a, View C, [Figure 4-18](#)) from couplers (5c) on rotating bed and connect to couplers (5b, View B) in butt.

CAUTION

Boom Hinge Pin Damage!

Step [12](#) must be performed to relieve trapped pressure in boom hinge pin cylinders. Otherwise, damage to parts can occur.

13. Lift butt onto transport vehicle.
14. Disconnect slings.

Disassemble Boom

The boom can now be disassembled using live mast.

See Lifcrane Mast Capacities Chart at the end of this section for lifting capacities.

Remove Counterweight



WARNING

Tipping Hazard!

To prevent the crane from tipping — remove crane counterweight before removing carbody counterweight.

Remove Crane Counterweight

The crane counterweight must be removed with an assist crane.

See [Figure 4-17](#) for the following procedure.

1. Remove counterweight side boxes (2, View F) one box at a time alternating from side to side.
2. Uncoil handling pendants (3, View B) from storage pockets in tray (1) and hook pendants to load block from assist crane (View C).



WARNING

Falling Load Hazard!

Pendants are designed to handle counterweight tray only. Do not attempt to lift tray with counterweight boxes installed. Pendants could break allowing counterweight tray and boxes to fall.

3. Hoist with assist crane until handling pendants are taut.
4. Remove hitch pins (7, View E) from counterweight pins (6) and install in storage lugs.
5. Disengage counterweight pins (6) with switch on remote control. Pins will engage if switch is released.
6. Travel, swing, and lower load as required with assist crane to disengage counterweight tray from hooks (5) in rotating bed (View D).
7. Lower counterweight tray onto ground at rear of crane.
Release switch on remote control to engage counterweight pins (6, View D) once tray is clear of holes.
8. Disconnect hydraulic hoses from counterweight cylinders at couplers (4, View A) on rear of rotating bed.
Coil hydraulic hoses on tray for storage.
9. Lift counterweight tray onto transport vehicle.
10. Unhook handling pendants from assist crane hook and coil pendants in storage pockets (View B).

**WARNING****Tipping Hazard!**

To prevent the crane from tipping — remove crane counterweight before removing carbody counterweight.

Remove Carbody Counterweight

See [Figure 4-15](#) for the following procedure.

General

The carbody counterweight can be removed with the live mast when the crane is in the following configuration:

- Mast assist arms fully raised. Mast will be at approximately 105° (assist arms supporting mast) when attaching carbody counterweights.
- Liftcrane Mast Capacities Chart selected on RCL configuration screen
- 360° swing permitted while handling counterweight
- Mast operated within limits of Liftcrane Mast Capacities Chart at the end of this section.

Removal

1. For **Series 3 only**, remove each side box:
 - a. Attach crawler handling shackles to lifting lugs (3) on side box (2).
 - b. Attach legs of chain sling to shackles.
 - c. Lift against side box until chain sling legs are taut.
 - d. Unpin side box from center box (store pins in side box holes).
 - e. Lift side box onto transport vehicle.
 - f. Disconnect chain sling and remove shackles.
 - g. Repeat steps for other side box.
2. For **Series 2 and 3**, proceed as follows:
 - a. Attach crawler handling shackles to lifting lugs (3) on center box (1).
 - b. Attach legs of chain sling to shackles.
 - c. Remove pins (6, View B). Store pins in center box holes once box is removed.
 - d. Boom, hoist, and swing as required to disengage slots (4, View C) in top of center box from hooks (5) on carbody.
 - e. Lift center box onto transport vehicle.
 - f. Disconnect chain sling and remove shackles.

3. Repeat steps 1 and 2 at other end of carbody.
4. Attach shackles to crawlers for storage.

Remove Crawler Stairways

See [Figure 4-16](#), View C for the following procedure.

If necessary, remove each crawler stairway as follows:

1. Attach nylon slings from assembly block on live mast to stairway (6).
2. Hoist as required to support stairway.
3. Remove quick-release pins (8). Store pins in platform holes once stairway is removed.
4. Slide stairway out of sleeves (7) on underside of platform.
5. Lift stairway onto transport vehicle and disconnect slings.

Store Crawler Platforms

See [Figure 4-16](#), View B for the following procedure.

1. Remove safety pins (3) from ends of platform extensions (1a).
2. Rotate platform extensions (1a) to stored position and install safety pins (3).
3. Remove hitch pins (4) and push supports (2) in.
4. Install hitch pins (4).

Remove Crawlers

The crane must be in the following configuration to remove crawlers:

- Mast arms fully raised
- Liftcrane Mast Capacities Chart selected on rated capacity configuration screen
- Mast operated within limits of Liftcrane Mast Capacities Chart at end of this section

**WARNING****Tipping Hazard!**

- Do not exceed capacities given in Liftcrane Mast Capacities Chart when handling crawlers with mast. Crane will tip forward.
- Make sure the crane is level. Check 2-way level on front of carbody. Adjust jacks as required.
- Do not swing 10° either side of center (see [Figure 4-10](#)).

CAUTION**Parts Damage!**

Avoid hitting carbody jacks with crawlers.

Remove First Crawler

See [Figure 4-14](#) for the following procedure.

Perform steps 1 through 4 at both crawlers.

1. Disconnect hydraulic hoses ([Figure 4-12](#)) between carbody and crawler:
 - Connect hose (11, View A) to coupler (12a).
 - Connect hose (12, View B) to coupler (11a).
 - Attach dust cap to end of hose (13, View B) and to coupler (13a). Secure hose to carbody for shipping.
2. Disconnect grease hose (14, [Figure 4-12](#), View C) between carbody and crawler.
 - Attach dust cap to end of hose and to coupler (14a).
 - Secure hose to carbody for shipping.
3. Disconnect crawler drive (see [Figure 4-14](#)):
 - a. Unpin drive shaft guard (9, View D) and slide guard back.
 - b. Support drive shaft (4, View C) and remove flange screws (8). Store screws in carbody flange holes once drive shaft is disconnected.
 - c. Retract crawler drive shaft and place on storage bracket (5, View B).
4. Attach chains (1, [Figure 4-14](#), View F) between crawler pads (2) and crawler lugs (3) (four places). Chains should be snug to prevent treads from sagging when crawler is lifted.
5. Perform steps 3 - 7 on [page 4-10](#) to deploy each carbody jack.

**WARNING****Moving Part Hazard!**

To avoid serious crushing injury — warn all personnel to stand clear of jacks.

Tipping Hazard!

Avoid tipping crane over — keep the crane level while jacking.

6. Using controls on front of carbody, extend carbody jacks until crawler treads are just clear of ground.
7. A 2-way level is provided near controls on front of carbody to aid in jacking.
8. Attach hooks from chain sling ([Figure 4-14](#), View E) to crawler as shown in [Figure 4-11](#).
9. Tilt operator's cab up, as required, so crawler does not hit cab.
10. Remove collars (3, [Figure 4-13](#), View D) and retract crawler connecting pins (2) with crawler pins control (4 or 5, View G).

**DANGER****Tipping Hazard!**

Do not allow assembly block to swing past inside edges of carbody jacks while removing first crawler. Crane will tip.

11. Slowly hoist and boom up or down as required to lift crawler clear of carbody.
12. Position trailer under suspended crawler.
13. Lower crawler onto trailer.
14. Disconnect chains from crawler and remove trailer.
15. Engage crawler pins and install collars (3, [Figure 4-13](#), View D).

Remove Second Crawler**WARNING****Tipping Hazard!**

To prevent the crane from tipping — limit swing to 10° either side of center when handling second crawler ([Figure 4-10](#), View E).

1. Swing 180° so assembly block from mast is centered over crawler.
2. Repeat steps 8 through 15 for other crawler.

Do not swing more than 10° either side of center when handling second crawler.

Remove Assembly Block

Follow instructions on [page 4-33](#).

Lower Live Mast To Shipping Position

See [Figure 4-9](#) for the following procedure.



WARNING

Falling Mast Hazard!

Do not raise mast to 115° until mast assist arms are fully raised. Mast will fall over backwards.

1. Select Liftcrane Mast Capacities Chart.
2. Increase engine speed to desired RPM.
3. If required, fully raise mast assist arms using mast switch on remote control.
4. BOOM UP with boom hoist control to lower live mast (1) to shipping position.
Mast assist arms will support mast as cylinders retract automatically.
5. Release boom hoist control once mast comes to rest on supports at rear of rotating bed.
6. Fully lower mast assist arms using mast switch on remote control.
7. Unpin cab strut from lug on cab support and rotate operator's cab 90° from operating position (View A).
 - a. With cab raise/lower switch on remote control lower cab to up to shipping position (View A).
 - b. Pin cab strut to lug on rotating bed (View A).
 - c. On top of cab, remove screws and move amber beacon to shipping (horizontal) position. Remove radio antenna.
8. Shut down engine.

Install Crane On Trailer

See [Figure 4-7](#) for the following procedure.

To install crane on trailer use the following steps:

1. Extend carbody jacks fully to provide clearance for trailer.

CAUTION

Equipment Damage!

Use extreme care not to hit jacks with trailer when backing trailer into position:

Provide a signal person to give instructions to truck driver.

2. Center transport trailer under carbody.
3. Slowly retract jacks to lower crane onto trailer.
4. Block both ends of the crane so it is firmly supported and fully retract jacks.
5. Store jack pads (View B).
6. Store each carbody jack as follows:
 - a. Remove connecting pin from working hole (View C).
 - b. Swing jack in.
 - c. Install connecting pin in storage hole (View C)
7. Rotate operator's cab to shipping position and secure with strut ([Figure 4-8](#)).

Remove Exhaust Pipes



WARNING

Burn Hazard!

Exhaust pipes are hot. Take every precaution to prevent being burnt when pipes are removed.

See [Figure 4-6](#) for the following procedure.

1. Remove rear enclosure panels (1, View A).
2. Unhook springs (4, View B) from clips (5) and remove both exhaust pipes (2) from working position.
3. Store exhaust pipes (2) in enclosure frame (View A).
4. Remove both rain caps (3) from working position (View A).
5. Install rain caps in shipping position and connect springs (4, View B) to clips (5).
6. Install rear enclosure panels (1).

Reference Only

THIS PAGE INTENTIONALLY LEFT BLANK

A13170

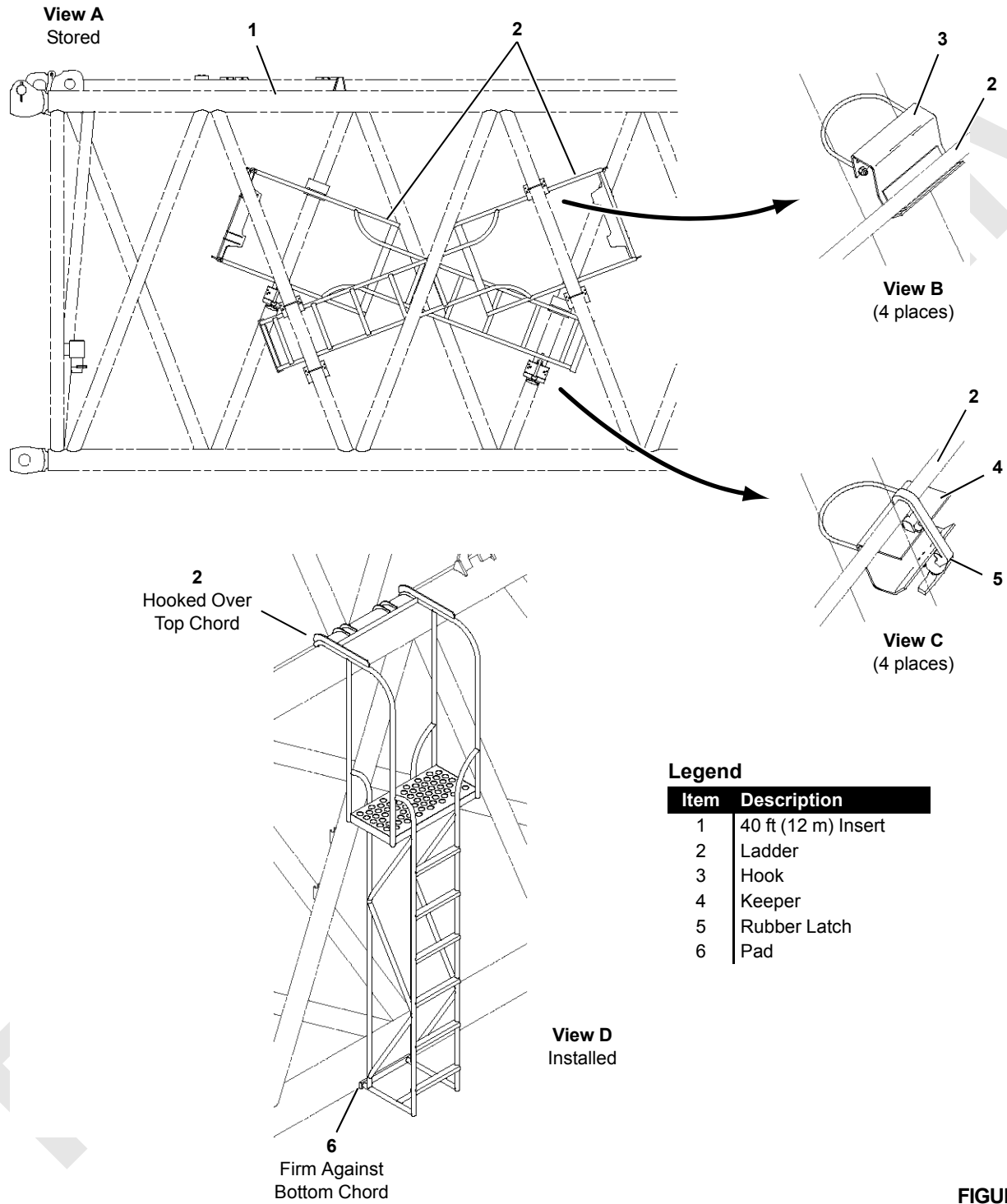

Legend

Item	Description
1	40 ft (12 m) Insert
2	Ladder
3	Hook
4	Keeper
5	Rubber Latch
6	Pad

FIGURE 4-23

BOOM LADDER ASSEMBLY

See [Figure 4-23](#) for the following procedure.



WARNING

To Prevent Serious Injury or Death:

- Limit load on ladder to 300 lb (136 kg).
- Avoid improper use. Ladder is intended for use only on Manitowoc #58 boom inserts. Any other use is prohibited.
- Use ladder for boom assembly/disassembly and maintenance only when boom is horizontal.
- Make sure ladder is properly secured to insert.
- Keep hands free of any objects while climbing ladder. Objects which cannot be carried in pockets or tool belts must be lifted into place onto ladder platform prior to climbing ladder.
- Stand only on platform. Do not stand on cross braces.

General

Two ladders (2) are stored inside 40 ft (12 m) heavy insert (1) as shown in View A. The ladders are designed for use in assembly/disassembly and maintenance of #58 boom sections and components. Each ladder weighs approximately 15 lb (6,8 kg).

Removing Ladders from Boom Butt

It is recommended that two people remove either ladder from the boom insert: one person inside the insert to unlatch and lift the ladder and another person outside the insert to help guide the ladder out of the insert. Use the following procedure:

1. Lower boom onto blocking at ground level. **Boom sections must be horizontal.**
2. Unhook rubber latches (5, View C).
3. Lift ladder (2) up and out of hooks (3, View C).
4. Guide ladder through lacings to outside of insert.

Installing Ladders on Boom Inserts

Lift ladder (2) to desired outside location on insert so ladder is securely hooked over backside of upper chord and lower pad (6) is firm against lower chord (View D).

Ladder must hang vertically against boom insert when in use.

Storing Ladders in Boom Butt

It is recommended that two people store either ladder in the boom insert: one person outside the insert to help guide the ladder into the insert and another person inside the insert to lift the ladder and latch it in position. Use the following procedure:



WARNING

Falling Load Hazard!

Ladders must be properly stored to prevent them from falling out of insert when boom is raised.

1. Hang ladder rails over hooks (3, View B) inside insert.
2. Pull rubber latches (5) tightly over lower rails and latch in keepers (4, View B).
3. Make sure ladder cannot move once latched.

BOOM RIGGING

Assist Crane Requirements

Either the live mast or an assist crane can be used to handle and assemble the boom section. See Crane Weights in Section 1 for the weights of boom sections.

Blocked Crawler

To prevent the crane from tipping, some boom and jib lengths must be raised and lowered over the end of blocked crawlers. See capacity charts for blocked crawler requirements and Crawler Blocking Diagram in Capacity Charts Manual for instructions.

Do not attempt to raise or lower boom from or to ground until crawlers are blocked, if required.

WARNING Tipping Hazard

Block ends of crawlers, if required, before you attempt to raise or lower boom from or to ground.

Handling Components

Handle boom and jib sections with care to avoid damaging lacings and chords. The boom and jib sections have lifting lugs designed to provide a balanced load and to prevent damage during lifting.

CAUTION

Personal Injury or Property Damage!

Ensure the boom remains properly secured in the shipping position to the boom insert or boom top during transportation loading or unloading and assembly or disassembly of the boom. Straps could shift or fall resulting in personal injury, property damage, or lacing damage if not properly secured.

WARNING Falling Load Hazard!

Lifting lugs on a particular boom or jib section are designed only for lifting that section only. Do not attempt to lift two or more boom or jib sections with lifting lugs only on one section. Lifting lugs may break allowing boom or jib sections to fall.

When lifting lugs are not used:

- **Lift against chords only, never against lacings.**
- Use nylon lifting slings. If wire rope or chain slings are used, install protective covering (such as sections of rubber tire) between slings and chords.

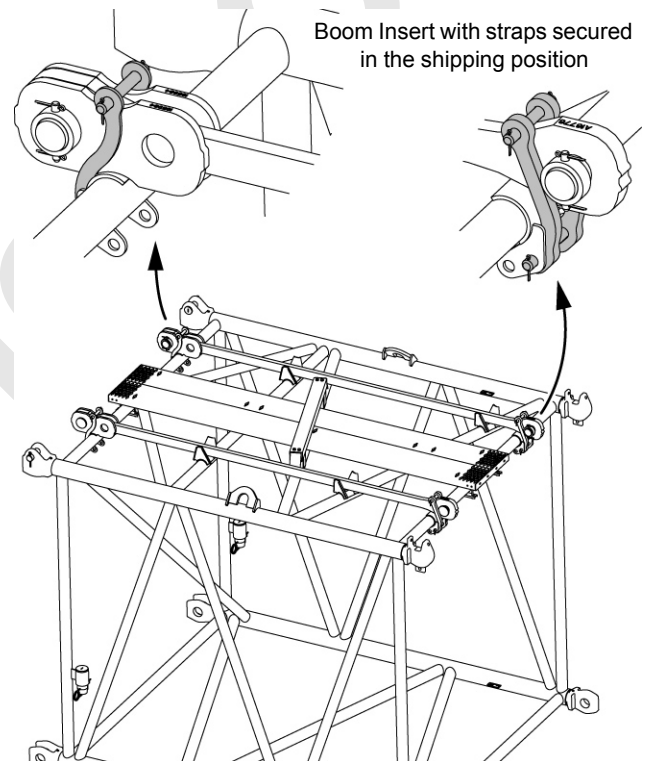

Boom Assembly Drawing

Boom sections (top, inserts, straps) must be assembled in proper sequence according to Boom Assembly Drawing at the end of this section.

WARNING

Collapsing Boom Hazard!

Boom can collapse if not assembled in correct sequence. Follow assembly sequence in Boom Assembly Drawing.

Identifying Boom and Jib Components

Boom and jib sections are marked for proper identification as shown in Views A and B, [Figure 4-24](#).

Boom and jib pendants are marked for proper identification as shown in View C, [Figure 4-24](#).

Boom straps and links are marked for proper identification as shown in View D, [Figure 4-24](#).

NOTE: The markings shown in [Figure 4-24](#) can vary depending on when your crane was produced and the original equipment manufacturer.

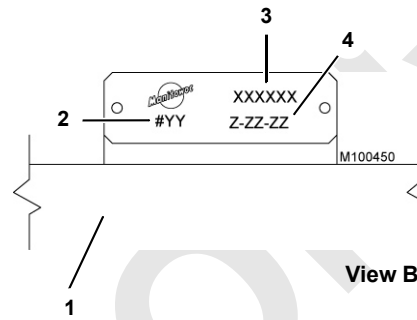
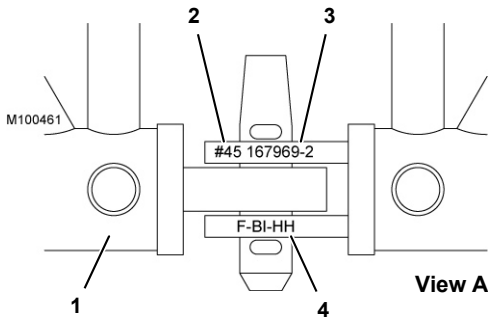

Item	Description
1	Boom or Jib Chord
2	Boom or Jib Number
3	Manitowoc Part Number
4	Manitowoc Manufacturing Code
5	Pendant
5a	Aluminum Tag (if equipped)
6	Manitowoc Purchase Order Number
7	Manufacturer's Number
8	Wire Rope Type
9	Diameter
10	Length
11	Set Number
12	Strap or Link

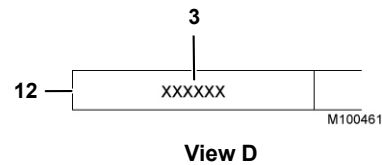
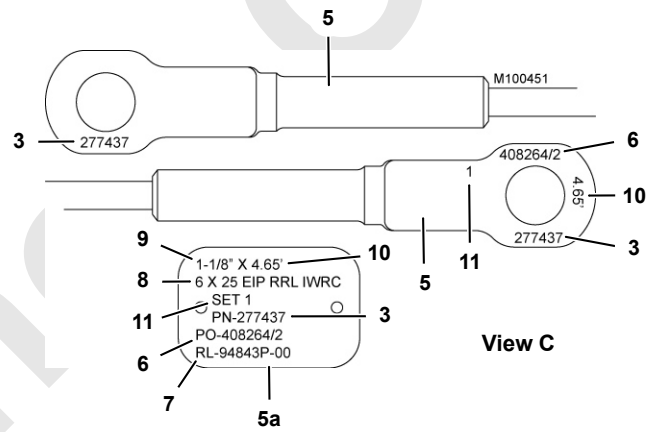
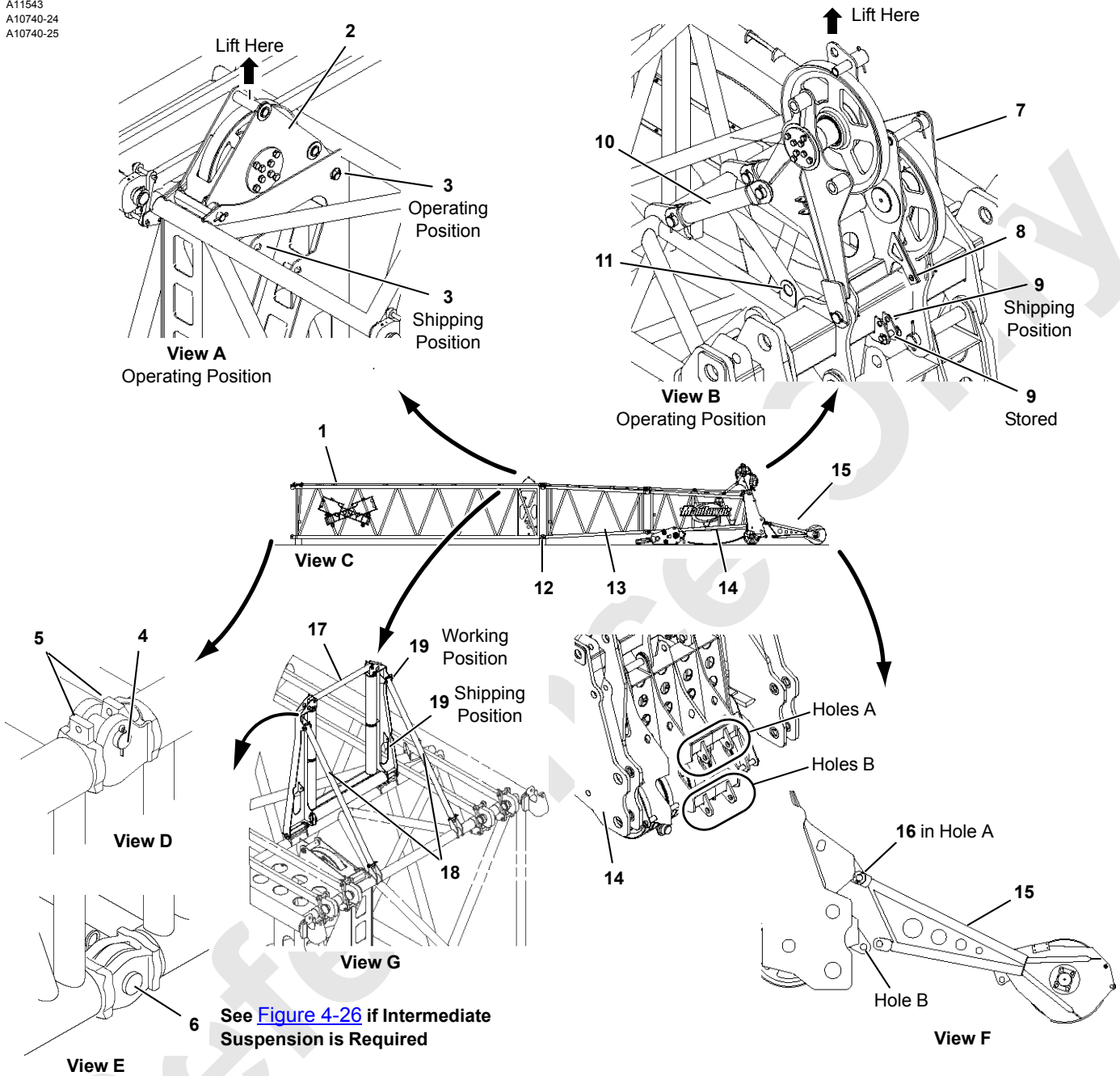

FIGURE 4-24

A11388
A11543
A10740-24
A10740-25



See [Figure 4-26](#) if Intermediate Suspension is Required

Item	Description	Item	Description
1	40 ft (12 m) Insert	11	Lug
2	Wire Rope Guide	12	Inserts
3	Pin with Snap Pins	13	Transition Insert
4	Fixed Horizontal Pin	14	Boom Top
5	Hooked Connector	15	Upper Boom Point Assembly
6	Bottom Connecting Pin	16	Pin with Snap Pins
7	Wire Rope Guide	17	Wire Rope Guide (Working Position)
8	Shipping Lug	18	Wire Rope Guide Struts
9	Pin with Snap Pins	19	Safety Pins
10	Strut		

FIGURE 4-25

**WARNING****Crushing Injury Hazard!**

Never work under or inside boom sections that are not securely blocked.

**WARNING****Falling Load Hazard!**

Luffing jib backstay straps can be stored on boom sections for shipping.

If jib will not be used, remove all jib backstay straps, links, and pins stored on boom sections.

Assemble Boom Sections

See [Figure 4-25](#) for the following procedure.

Boom sections must be assembled in proper sequence.

See Boom Assembly Drawing at the end of this section for assembly sequence.

1. If luffing jib will not be used, remove all jib backstay straps, links, and pins stored on boom sections.
2. Place 40 ft (12 m) heavy insert (1) on blocking approximately 6 in (152 mm) high. This insert has a sheave frame at top end of insert.

NOTE: Each boom section has four lifting lugs in top chords.

**WARNING****Pinch Point Hazard!**

Keep hands clear of openings in wire rope guide frame while raising or lowering wire rope guide in step 3.

3. If required for luffing jib or for auxiliary drum, raise wire rope guide (2, View A) to operating position:

- a. Attach a sling to rope guide pin.
- b. Support wire rope guide with hoist and remove pin (3) from shipping position.
- c. Raise wire rope guide to operating position and install pin (3).

4. Lift next insert into position and engage fixed horizontal pins (4, View D) in insert with hooked connectors (5) in adjacent insert.
5. Lower insert to horizontal and install both bottom connecting pins (6, View E).

NOTE: If intermediate suspension is required, standard bottom connecting pins (6) are replaced with longer connecting pins and links (see [Figure 4-26](#) and Boom Assembly Drawing).

6. Block under top end of insert.
7. Repeat steps 4 – 6 for each remaining insert (12) and for boom top (14).

NOTE: Transition insert (13) must be installed next to boom top (14).

8. Raise boom top wire rope guide (7, View B) to operating position:
 - a. Attach a sling to hole in rope guide.
 - b. Support wire rope guide with hoist and remove pin (9) from shipping position.
 - c. Raise wire rope guide to operating position.
 - d. Store pin (9).
 - e. Unpin struts (10) from storage lugs (11) and pin to wire rope guide.
9. Raise wire rope guide (17, View G) to working position:
 - a. Remove safety pins (19) from shipping position.
 - b. Rotate wire rope guide up to working position.
 - c. Support guide and secure to struts (18) with safety pins (19).

A11543-1
A11543-2

Collars Toward Inside
of Boom Sections

Luffing Jib Straps, Links, and all Hardware Must be
Removed if Luffing Jib is Not Used

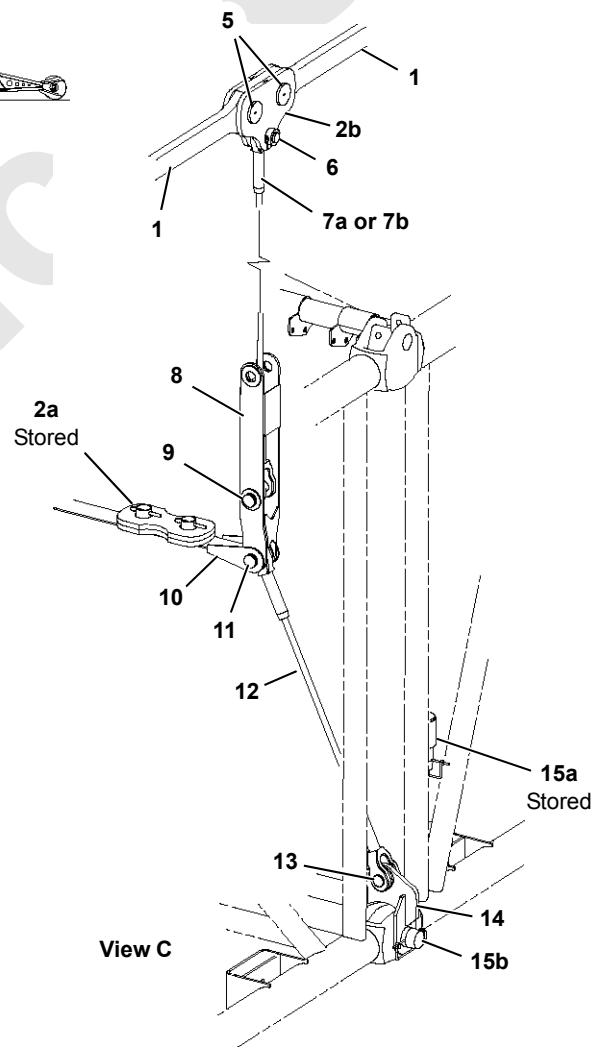
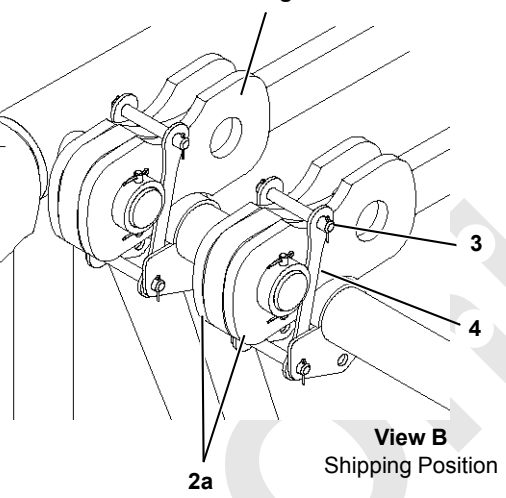
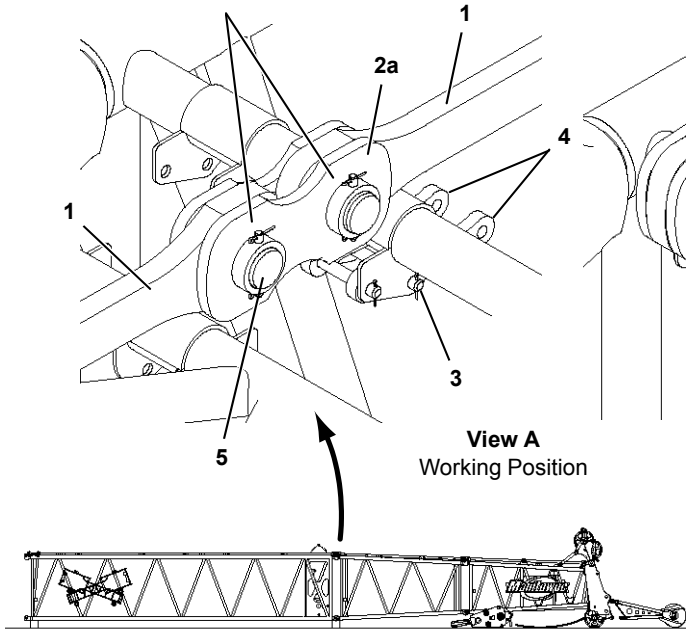

Legend

Item	Description
1	Strap
2a	Link (Standard)
2b	Link (Intermediate Suspension)
3	Pin (shipping)
4	Link (shipping)
5	Pin, with Collar, Retaining Pin, and Cotter Pins
6	Pin, with Collar, Retaining Pin, and Cotter Pins
7a	Pendant, 8 ft (2,4 m) Long
7b	Pendant, 8 ft, 7 in (2,6 m) Long
8	Adjustable Link
9	Pin
10	Link
11	Pin
12	Pendant
13	Pin
14	Link
15a	Pin (Standard)
15b	Pin, 7-3/4 in (197 mm) Long

NOTE: The intermediate suspension parts are stored in the boom butt and in the parts box supplied with the crane.

FIGURE 4-26

Connect Boom Straps

See [Figure 4-26](#) for the following procedure.

The boom straps and links are shipped on the boom sections as shown in View B.

1. Connect straps (1, View A) at top end of butt and each insert as follows:
 - a. Remove pins (3, View B) and rotate links (4) to working position (View A).
 - b. Pin links (4, View A) in working position.
 - c. Remove pin (5, View A) from end of each strap (1).
 - d. Rotate links (2a, View B) rearward and pin to adjacent strap with pin (5, View A).

NOTE: If intermediate suspension is required (see Boom Assembly Drawing), use links (2b, View C) in place of links (2a, View A).

Store links (2a) on link (10, View C).

NOTE: Intermediate suspension is required at locations specified in Boom Assembly Drawing.

1. If not already done, replace links (2a, View A) with links (2b, View C).

See View C for the remaining steps.

2. If not already done, remove and store standard pin (15a).
3. Using pin (15b), install link (14) and reconnect inserts.
4. Attach pendant (12) to link (14) with pin (13).
5. Connect pendant (12) and either adjustable link (8) or pendant (7a or 7b) to link (10) with pin (11).
6. If adjustable link (8) is required, pin pendant (7a or 7b) to adjustable link with pin (9).

Pin pendant to proper holes in adjustable link as specified in [Figure 4-27](#).

7. Pin pendant (7a or 7b) to links (2b) with pin (6).
8. Repeat steps 1 – 7 on other side of insert.

When boom is raised, boom straps will lift intermediate suspension into position and support inserts.

Install Intermediate Suspension

See [Figure 4-26](#) and [Figure 4-27](#) for the following procedure.

A13137

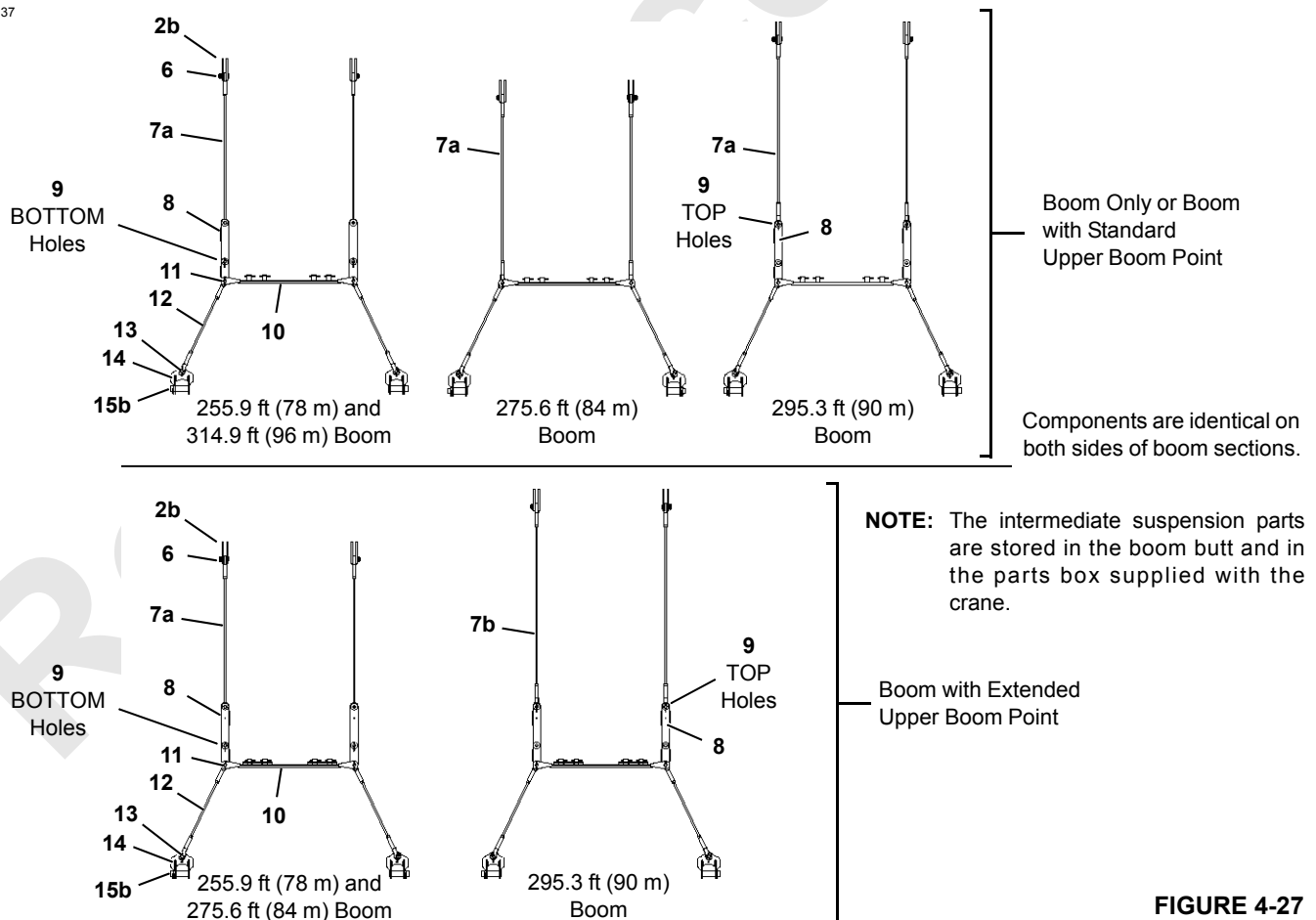
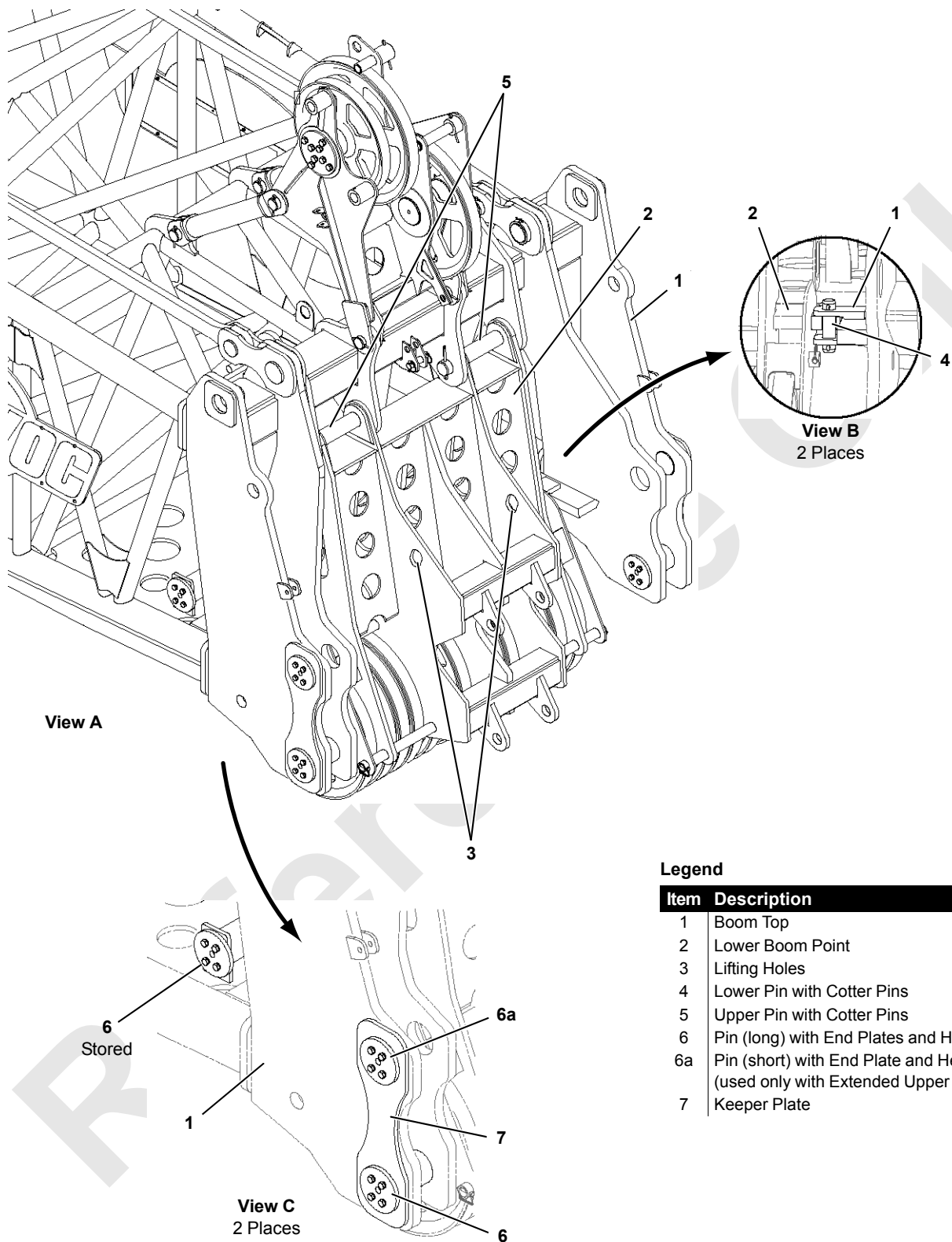

FIGURE 4-27

A11388-4,5,6



Legend

Item	Description
1	Boom Top
2	Lower Boom Point
3	Lifting Holes
4	Lower Pin with Cotter Pins
5	Upper Pin with Cotter Pins
6	Pin (long) with End Plates and Hex Screws
6a	Pin (short) with End Plate and Hex Screws (used only with Extended Upper Boom Point)
7	Keeper Plate

FIGURE 4-28

Install Standard Upper Boom Point

See [Figure 4-25](#), View F for the following procedure.

Do not install standard upper boom point if an extended upper boom point or luffing jib will be installed.

1. Using nylon lifting slings, lift upper boom point (15) into position at lower boom point.
2. Remove top pin (16) from holes in upper boom point.
3. Align upper holes (A) and install pin (16).
4. Rest upper boom point on ground.
5. Remove slings.
6. Slowly raise boom until bottom holes (B) are aligned.
7. Install pins (16) in holes (B).

CAUTION

Avoid Upper Boom Point Damage!

Do not rest weight of entire boom on standard upper boom point. Structural damage will occur.

Install Extended Upper Boom Point

See [Figure 4-28](#) for the following procedure.

1. Remove lower boom point, as follows:
 - a. Lower boom until sheaves in lower boom point (2) are just clear of ground.
 - b. Attach hooks from assist crane to lifting holes (3, View A) in lower boom point (2).
 - c. Remove lower pins (4, View B).
 - d. Hoist against lower boom point with assist crane until upper pins (5, View A) are loose and remove upper pins.
 - e. Swing lower boom point away from boom top and store.
 - f. Store pins (4 and 5) in lower boom point holes.
 - g. Lower boom top onto blocking at least 12 in (305 mm) high.
2. If installed, remove pins (6 or 6a, View C) with end plates and keeper plates (7) from boom top (1).

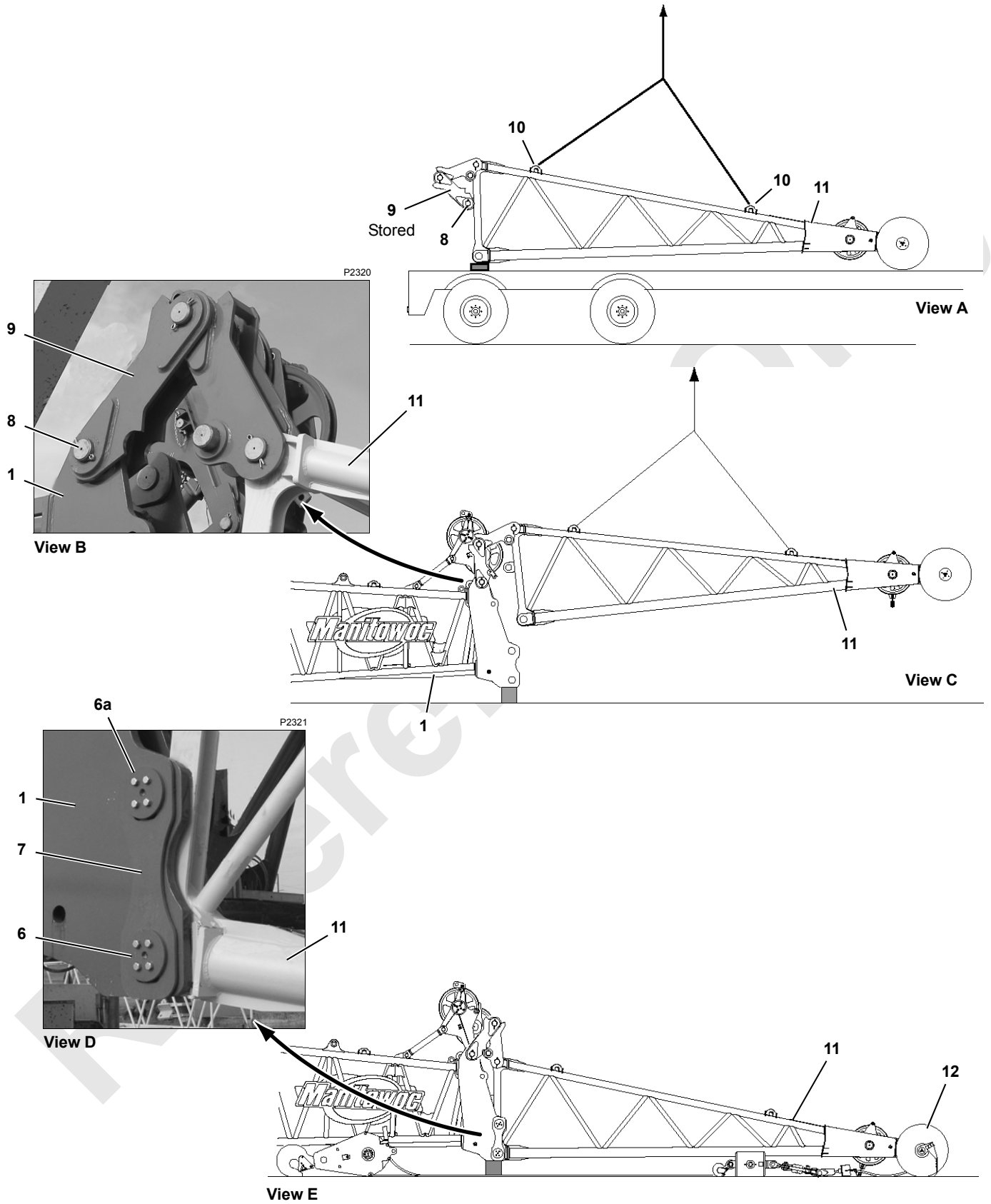

FIGURE 4-29

3. For past production units, proceed as follows:

See [Figure 4-29](#) for the following procedure.

- a. Remove pins (8, View A) to disconnect links (9) from storage position and rotate links (9) to vertical.
- b. Attach equal length lifting slings from assist crane to four lifting lugs (10, View A) on extended upper boom point (11).
- c. Lift extended upper boom point (11) off trailer and into position at boom top (1, View C).
- d. Align connecting holes in links (9, View B) with boom top (1) and install pins (8).
- e. Lower extended upper boom point until bottom holes are aligned.
- f. Install bottom pins (6, View D), keeper plates (7) and end plates.
- g. Lower upper boom point until rollers (12, View E) are on ground and disconnect lifting slings.

- h. If equipped with long top pins (6) in upper holes, store them with end plates ([Figure 4-28](#), View C).
- i. Install short top pins (6a, View D) and outboard end plates.
- j. Securely tighten end plate screws for pins (6 and 6a).
- k. As boom is raised, extended upper boom point rollers (12) will roll along ground until links unfold. Upper point will then lift off ground as boom is raised.

Make sure roller path is clear of obstructions.



Prior to raising boom, warn personnel to stand clear of extended upper boom point rollers.

Legend for [Figure 4-29](#)

Item	Description	Item	Description
1	Boom Top	9	Link
6	Pin (long) with End Plates and Hex Screws	10	Lifting Lug
6a	Pin (short) with End Plate and Hex Screws	11	Extended Upper Boom Point
7	Keeper Plate	12	Roller
8	Pin with Cotter Pins		

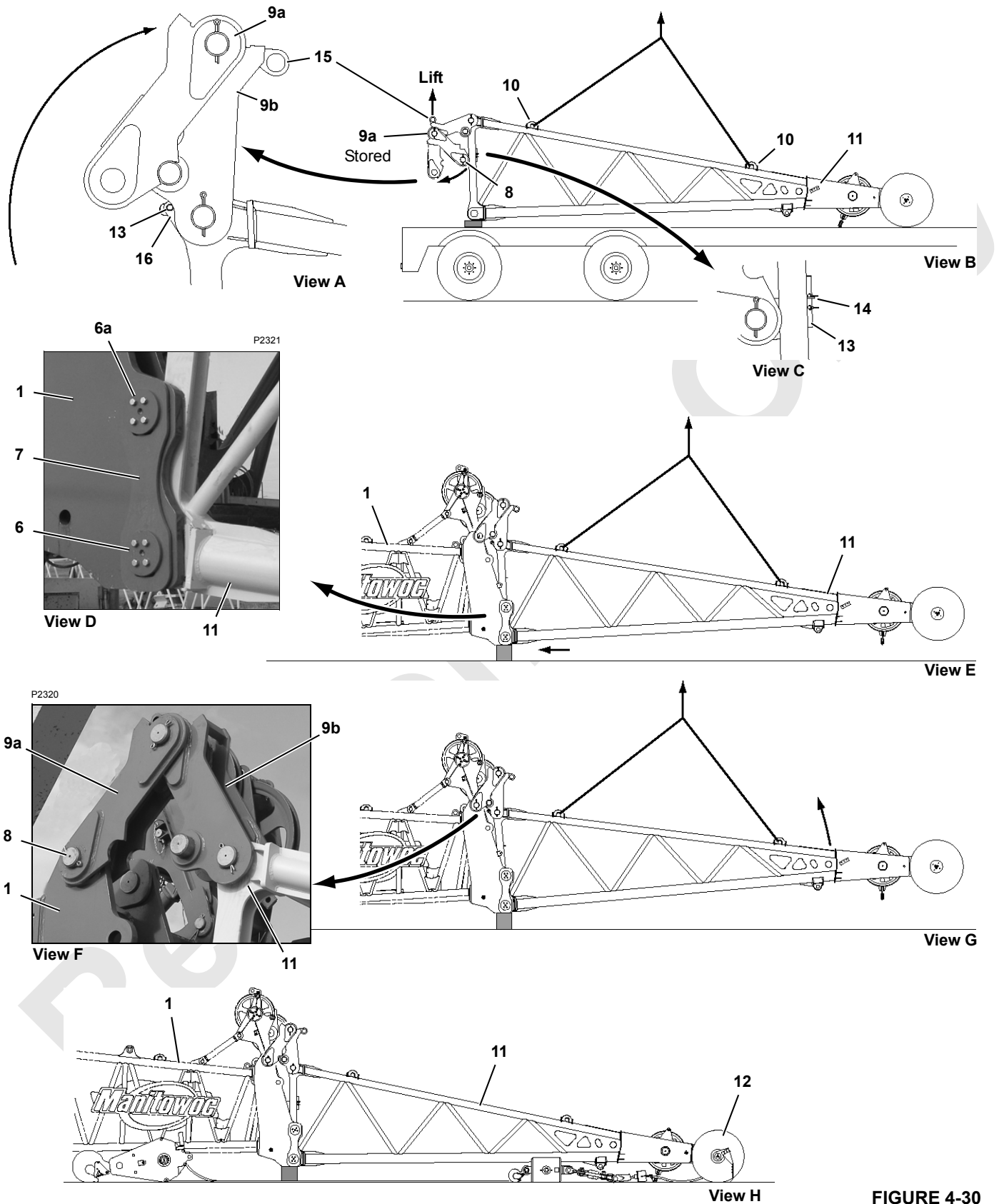

FIGURE 4-30

4. For current production units, proceed as follows:

See [Figure 4-30](#) for the following procedure.

- a. Remove pins (8, View B) to disconnect links (9a) from storage position and rotate links (9a) to vertical.
- b. Remove setup pins (13, View C) from storage lugs (14).
- c. Attach a lifting sling from assist crane to lifting lug (15, View A) on link (9b).
- d. Rotate links (9a and 9b, View A) up until setup pin (13) can be installed in setup lug (16).
- e. Install setup pin (13).
- f. Disconnect lifting sling.
- g. Repeat steps 4c – 4f at other set of links (9a and 9b).
- h. Attach equal length lifting slings from assist crane to four lifting lugs (10, View B) on extended upper boom point (11).
- i. Lift extended upper boom point (11) off trailer and into position at boom top (1, View E).
- j. If equipped with long top pins (6) in upper holes, store them with end plates (View C, [Figure 4-28](#)).
- k. Install bottom pins (6, View D), keeper plates (7), and end plates.

- l. Install short top pins (6a, View D) and outboard end plates.
- m. Securely tighten end plate screws for pins (6 and 6a).
- n. Rotate extended upper boom point up with assist crane (View G) to align connecting holes in links (9a, View F) with boom top (1).
- o. Install pins (8).
- p. Remove setup pins (13, View A) from setup lugs (16) and install pins in storage lugs (14, View C).
Do not perform step 4q until pins (13) are removed, or damage will result.
- q. Lower upper boom point until rollers (12, View H) are on ground and disconnect lifting slings.
- r. As boom is raised, extended upper boom point rollers (12) will roll along ground until links unfold. Upper point will then lift off ground as boom is raised.

Make sure roller path is clear of obstructions.



Prior to raising boom, warn personnel to stand clear of extended upper boom point rollers.

Legend for [Figure 4-30](#)

Item	Description	Item	Description
1	Boom Top	10	Lifting Lug
6	Pin (long) with End Plates and Hex Screws	11	Extended Upper Boom Point
6a	Pin (short) with End Plate and Hex Screws	12	Roller
7	Keeper Plate	13	Setup Pin with Snap Pins
8	Pin with Cotter Pins	14	Storage Lug
9a	Link	15	Lifting Lug
9b	Link	16	Setup Lug

Install Load Line

See [Load Block Reeving](#) instructions for proper routing and reeving of load lines.

Connect Boom Wiring

1. Install block-up limit components shown in [Figure 4-32](#) and in Boom Wiring and Limits Electrical Drawing at the end of this section.
2. Install wind speed indicator assembly if removed for shipping. Use star washers to attach mounting bracket to boom top to provide a good ground (see Wind Speed Assembly drawing at the end of this section).
3. Connect electric cables from cable reel in boom butt to node controller in boom butt and to wireless transceiver in boom top (see Boom Wiring and Limits Electrical Drawing at the end of this section).
4. Connect electric cables from block-up limit switches and wind speed transmitters to proper receptacles on boom and jib node controllers.
5. To protect electrical components:
 - a. Attach sealing caps to ends of all unused cables, unused receptacles, and unused terminator plugs.
 - b. If equipped, attach terminator plugs to unused receptacles.
6. Remove optional boom light from shipping position tube by loosening thumbscrew at base of light. Position on working position tube (see [Figure 4-31](#)) and tighten thumbscrew to secure. Connect boom light to electrical cable WCLE.

Shipping Position

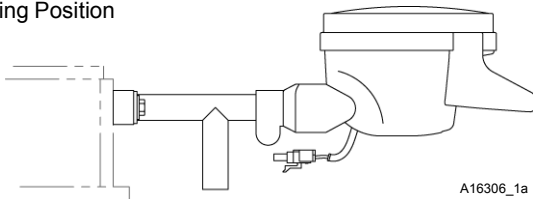

Working Position

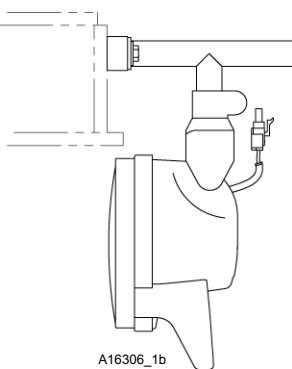

A16306_1a

A16306_1b

FIGURE 4-31

Perform Pre-Raising Checks

Perform following pre-raising checks and correct any defects before raising boom.

- Crane on firm, level surface.
- Crawlers blocked if required per Capacity Chart.
- All connecting pins installed and properly retained.
- Boom inserts installed in proper sequence.
- Boom straps installed in proper sequence.
- All jib backstay straps, links, and pins removed from boom sections (if luffing jib will not be used).
- All insert and strap connecting pins installed and properly retained.
- Mast arms fully lowered.
- Boom hoist wire rope spooled tightly onto drum and engaged with proper sheaves. Wire rope securely anchored to socket and wedge at mast.
- Load lines spooled tightly onto drums and engaged with proper sheaves. Load lines securely anchored to sockets at boom points or at load block and weight ball.
- All blocking, tools, and other items removed from boom.
- Electronic boom angle indicator properly installed and adjusted.
- Block-up limit control properly installed and operational.
- Rated Capacity Indicator/Limiter properly installed and operational.
- Proper capacity chart selected on configuration screen of RCL display.
- Automatic boom stop properly installed. Must be adjusted after boom is raised.
- Crane and attachment properly lubricated.
- Wind within allowable limits for operation.

Boom Removal

Boom removal is the reverse of installation.

WARNING Tipping Hazard!

Prevent the crane from tipping. Block ends of crawlers, if required per capacity chart, before raising or lowering boom from or to ground.

**WARNING****Crushing Injury Hazard!**

Boom inserts can collapse when connecting pins are removed. Block both ends of each boom insert before removing connecting pins.

Never work under or inside boom inserts that are not securely blocked.

1. Prepare crane and boom as follows:
 - a. Position the crane in disassembly area.
 - b. If required per capacity chart, travel front crawler rollers onto blocking (at boom end of crane).
See Crawler Blocking Diagram in Capacity Chart Manual for blocking requirements.
2. Lower boom to ground as follows:
 - **If equipped with a fixed or luffing jib**, see Jib Rigging Guide for procedure.
 - **If equipped with a standard upper boom point**, remove it (reverse assembly steps) before upper point contacts ground. **Upper point cannot support weight of boom.**
 - **If equipped with an extended upper boom point**, make sure ground is clear of obstruction so upper point rollers can roll freely as boom is lowered.

CAUTION**Pendant Damage!**

Use extreme care while lowering boom equipped with intermediate suspension. Boom straps can land on and crush intermediate suspension pendants.

**WARNING****Crushing Injury Hazard!**

Do not attempt to unpin straps until they are resting firmly in strap brackets.

3. Continue to lower boom onto blocking until boom straps are resting in brackets on boom inserts.
Push intermediate suspension pendants to inner side of boom as boom is lowered.
4. Remove and store intermediate suspension pendants, links and pins. Block under inserts before removing lower connecting pins.

5. Store insert straps and links.

NOTE: It is not necessary to remove the boom straps. The straps can be left on the inserts for shipping.

- a. Rotate links at front end of butt and inserts forward for storage ([Figure 4-26](#), View B).
- b. Rotate storage links (4, [Figure 4-26](#), View B) to shipping position and pin to secure links and straps.
6. Remove and store block-up limit components (see Boom Wiring and Limits Electrical Drawing at the end of this section).
7. Remove and store wind speed indicator assemblies so they cannot be damaged during shipping (see Wind Speed Assembly drawing at the end of this section).
8. Disconnect electric cables from cable reel in boom butt at node controller in boom butt and at wireless transceiver in boom top (see Boom Wiring and Limits Electrical Drawing at the end of this section).
9. Coil cable onto cable reel.
10. Disconnect electric cables between boom top and upper point or luffing jib.
11. To protect electrical components:
 - a. Attach sealing caps to ends of all unused cables, unused receptacles, and unused terminator plugs.
 - b. If equipped, attach terminator plugs to unused receptacles.
 - c. Disconnect optional boom working light from electrical cable WCLE. Loosen thumbscrew, remove from working position tube and secure in shipping position in boom butt (see [Figure 4-31](#)).
12. Disconnect load lines from load block and weight ball and spool load lines onto load drums.
13. Remove fixed jib or luffing jib if installed.
14. Remove extended upper boom point if installed (reverse assembly steps).
15. Lower wire rope guide (17, View G) to shipping position:
 - a. Support wire rope guide (17).
 - b. Remove safety pins (19) from struts (18).
 - c. Rotate wire rope guide down to shipping position and install safety pins (19).
16. Store boom top wire rope guide ([Figure 4-25](#), View B):
 - a. Attach a sling to hole in wire rope guide (7).
 - b. Support wire rope guide (7) with hoist.
 - c. Unpin struts (10) from wire rope guide and pin to storage lugs (11).

- d. Lower wire rope guide (7) to shipping position.
- e. Using pin (9) pin lug (8) to upper boom point.

! WARNING
Pinch Point Hazard!

Keep hands clear of openings in wire rope guide frame while lowering wire rope guide in step 17.

- 17. Store wire rope guide in 40 ft (12 m) heavy insert (Figure 4-25, View A):

- a. Attach a sling to rope guide pin.
- b. Support wire rope guide (2) with hoist and remove pin (3) from operating position.
- c. Lower wire rope guide to shipping position and install pin (3).

- 18. Disassemble boom sections.

- 19. Disconnect boom butt from boom. See [Remove Boom Butt](#).

NOTE: If shims are used, store shims on boom pins.

See Legend on [page 61](#)

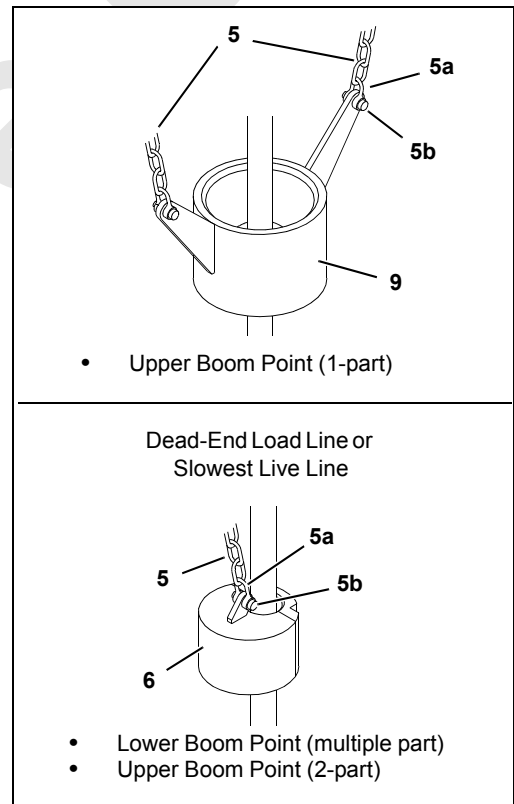
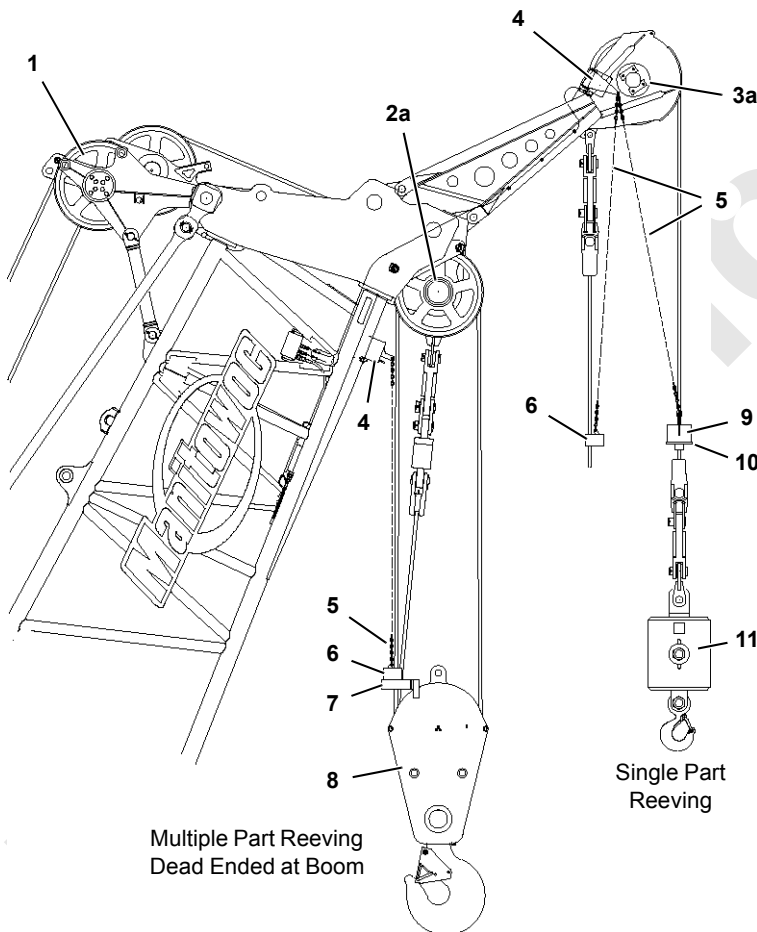

Location of Components at Boom Top Shown
Location of Components at Jib Tops is Similar

See Load Block Reeving Diagrams for Suggested Location of Weight with Multiple Part Reeving

FIGURE 4-32

Item	Description	Item	Description
1	Wire Rope Guide	5b	Pin
2a	Lower Boom Point	6	Weight
2b	Extended Upper Boom Point (lower sheaves)	7	Lift Plate
3a	Standard Upper Boom Point	8	Load Block
3b	Extended Upper Boom Point (upper sheave)	9	Weight
4	Block-Up Limit Switch	10	Lift Block
5	Chain	11	Weight Ball
5a	Shackle		

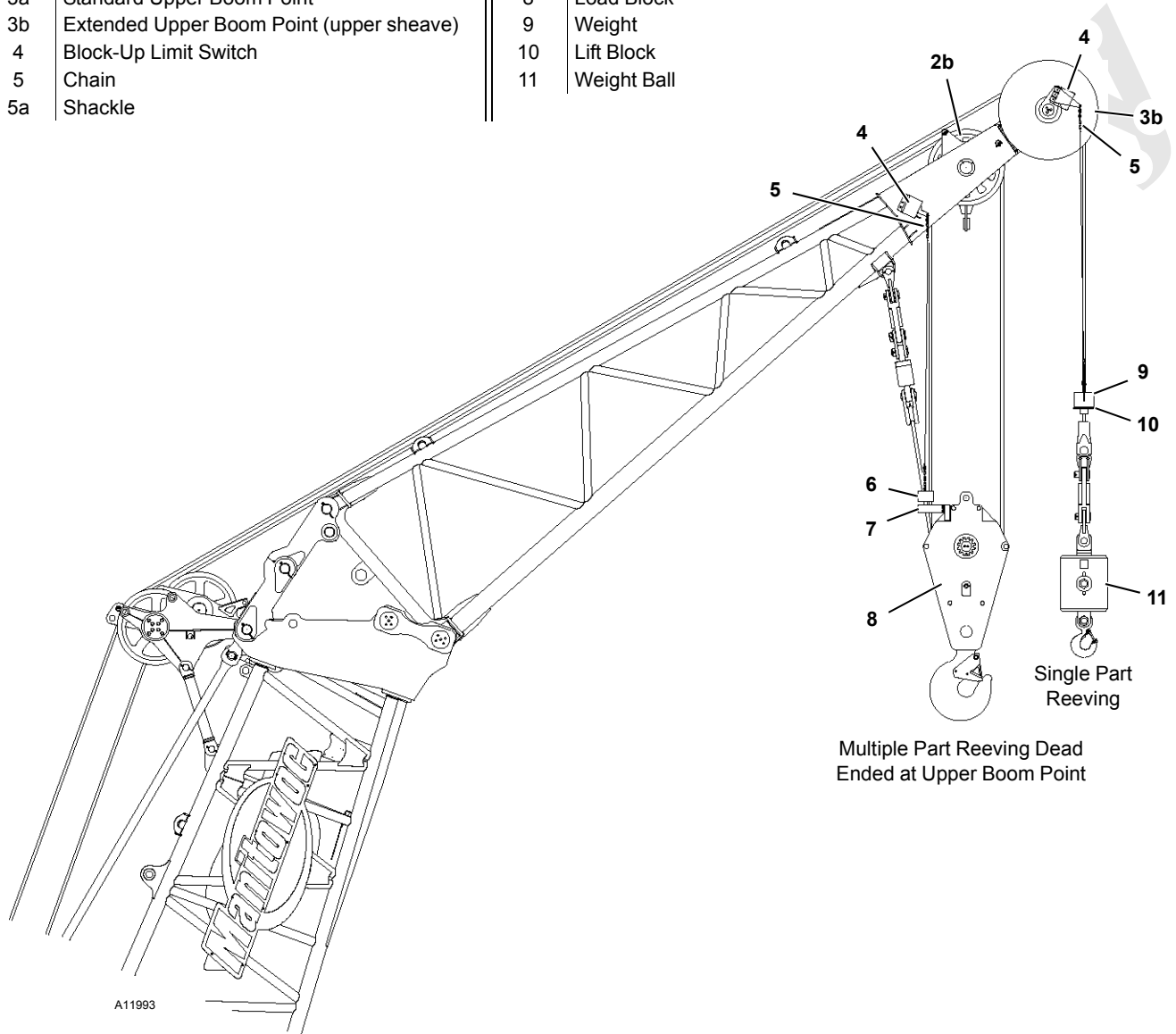

Multiple Part Reeving Dead Ended at Upper Boom Point

4

FIGURE 4-32 continued

WIRE ROPE INSTALLATION

NOTE: Wire rope manufacturer’s recommendations take precedence over information in this section.

Wire Rope Storage

Store wire rope in coils or on reels off the ground or floor in a clean and dry indoor location. If outdoor storage is necessary, the wire rope must be covered with a protective wrapper. Keep the wire rope away from acids, fumes, and other corrosives. Keep the wire rope away from heat that can dry out the lubricant. If the storage period will be long, lubricate the wire rope and perform periodic inspection given in this section at least monthly.

Removing Wire Rope from Shipping Reel

CAUTION!

Wire Rope Damage!

Shipping reel must rotate when wire rope is unwound. Attempting to remove wire rope from a stationary reel can result in a “kinked” wire rope, and wire rope will be ruined.

1. Mount wire rope shipping reel on a shaft supported at both ends by jacks or blocks as shown in [Figure 4-33](#).

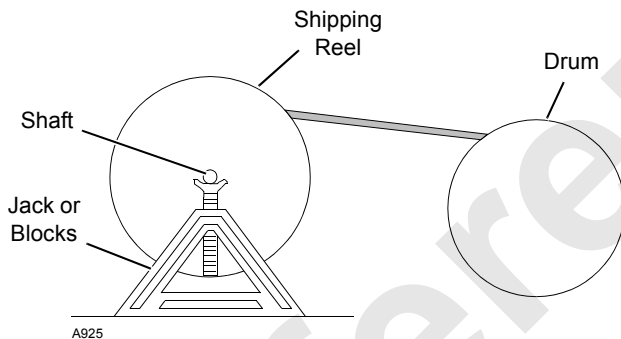

FIGURE 4-33

2. Provide a brake at shipping reel (see [Figure 4-34](#)) so wire rope can be wound tightly onto drum.

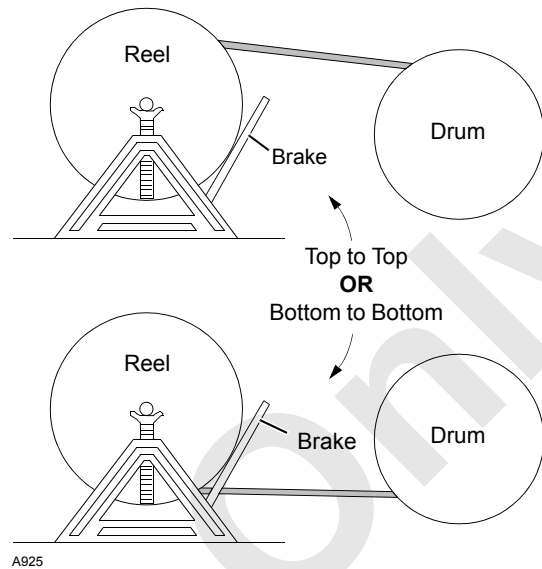

FIGURE 4-34

3. Avoid a reverse bend when winding wire rope onto drum: wind from top of reel to top of drum or from bottom of reel to bottom of drum as shown in [Figure 4-34](#).
4. Avoid dragging wire rope in dirt or around objects that can scrape, nick, cut, or crush wire rope.

Seizing and Cutting Wire Rope

Apply tight seizings of annealed wire to the ends of all wire rope. If not done, the rope wires and strands may slacken. This action will result in overloading of some strands and underloading of others. Bird caging and breakage of the wire rope can occur.

Before cutting wire rope, apply seizings on both sides of the point where the cut will be made. Then cut the wire rope with a torch, rope cutter, or abrasive cut-off wheel.

See [Figure 4-35](#) for:

- Number of seizings to be applied to the ends of wire rope and to both sides of the point where a cut will be made
- Proper application method: each seizing should be one rope diameter long.

Wire Rope Type	Seizings Required
Preformed	1
Non-preformed	3

Place free end of seizing wire in valley between two stands. Then wind seizing wire over free end as shown. Finally, twist and pull two ends of seizing wire together until seizing is tight.

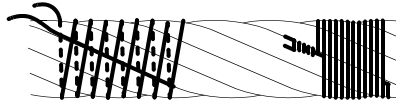

View A — Rope Diameter 1 in (25,4 mm) and Larger

Wind seizing wire around wire rope as shown. Then twist two ends of seizing wire together at center of seizing. Alternately twist and pull ends until seizing is tight.

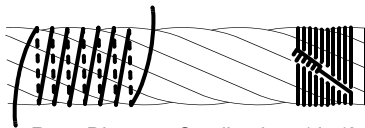

View B — Rope Diameter Smaller than 1 in (25,4 mm)

A925

FIGURE 4-35

Anchoring Wire Rope to Drum

See [Figure 4-36](#) for the following procedure.

Use the correct wedge part number for the size of wire rope being used; see parts drawing for the boom hoist drums or for the load drum shaft to obtain the correct part number.

1. Assemble wire rope and wedge to drum socket.
2. Tighten wedge, rapping back of wedge with a brass drift pin and hammer.

Drum Guards

The drums are equipped with guards which cover the dead-end sockets on the outside of the drum flanges.



WARNING

Moving Machinery Hazard!

Guards must be secured to drums during crane operation. When guards are removed for wire rope installation, use extreme care to prevent injury from a moving dead-end socket.



WARNING!

Falling Load Hazard!

Wire rope can be pulled out of drum if the following steps are not taken.

- Install straight wedge so corrugated side is against wire rope.
- Install wedge so end of wire rope extends past end of wedge, but not out of drum socket.
- Make sure seizing is not under wedge. Remove seizing if it interferes with assembly.

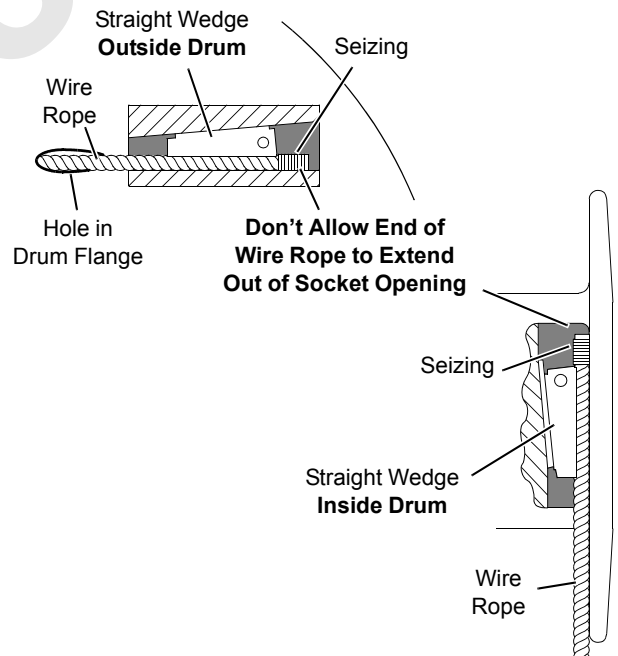

FIGURE 4-36

THIS PAGE INTENTIONALLY LEFT BLANK

Winding Wire Rope onto Drum

See Drum and Lagging Chart in Capacity Chart Manual for correct size of drum laggings, if used.

See Wire Rope Specifications Chart in Capacity Chart Manual for correct type, size, and amount of wire rope to be installed on load drums.

See Boom Assembly Drawing at the end of this section for correct type, size, and amount of wire rope to be installed on boom hoist drums.

1. Carefully inspect drums and all rope guides, rollers, and sheaves for defects that can cause wire rope to wear or be cut. If defects cannot be fixed, replace faulty parts.
2. Apply tension to wire rope as it is wound slowly onto drum.

First wrap must be tight against drum flange for approximately three-fourths of drum diameter (see [Figure 4-37](#)).

3. Tap adjacent wraps against each other with a soft metal or wooden mallet.

Use extreme care not to put twists or turns in wire rope; allow rope to assume its natural lay.

CAUTION!

Wire Rope Damage!

Voids or spaced wraps in first layer (see [Figure 4-37](#), View B) will permit movement and a wedging action with subsequent layers. Wedging action will cause crushing and abrasion of wire rope.

Never allow wire rope to “cross wind” on drums.

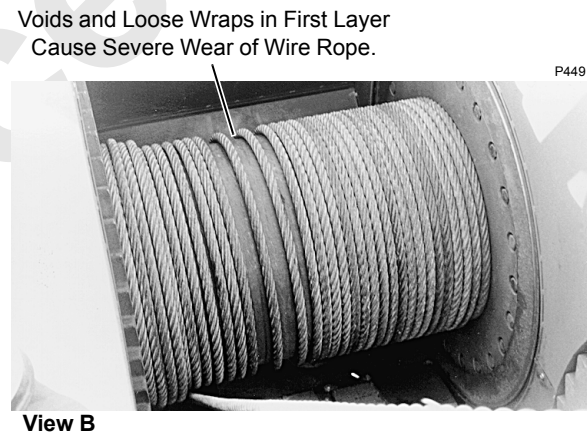
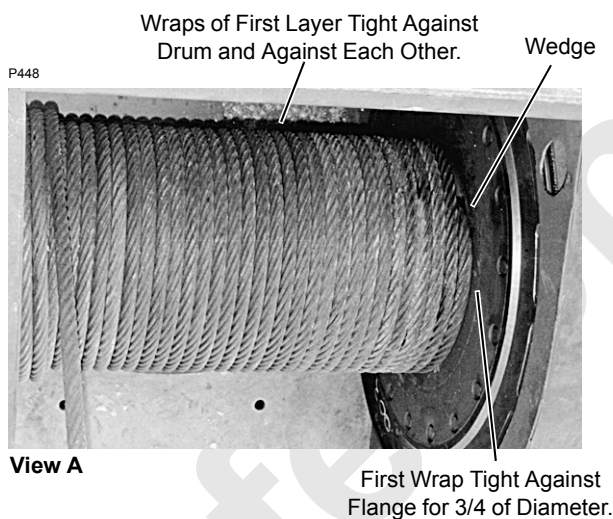

FIGURE 4-37

TL (Tail Length)

Standard 6 to 8 Strand Wire Rope

Minimum of 6 rope diameters, but not less than 6 in (152 mm).

Rotation Resistant Wire Rope

Minimum of 20 rope diameters, but not less than 6 in (152 mm).

T (Rope Clip Nut Torque)

inch (mm)	Wire Rope/Clip Size			
	7/8 (22,23)	1 (25,4)	1-1/8 (28,58)	1-1/4 (31,75)
	Torque			
* ft/lbs (kN/m)	225 (0,30)	225 (0,30)	225 (0,30)	360 (0,49)

* Tightening torque values shown are based on threads being clean, dry and free of lubrication.

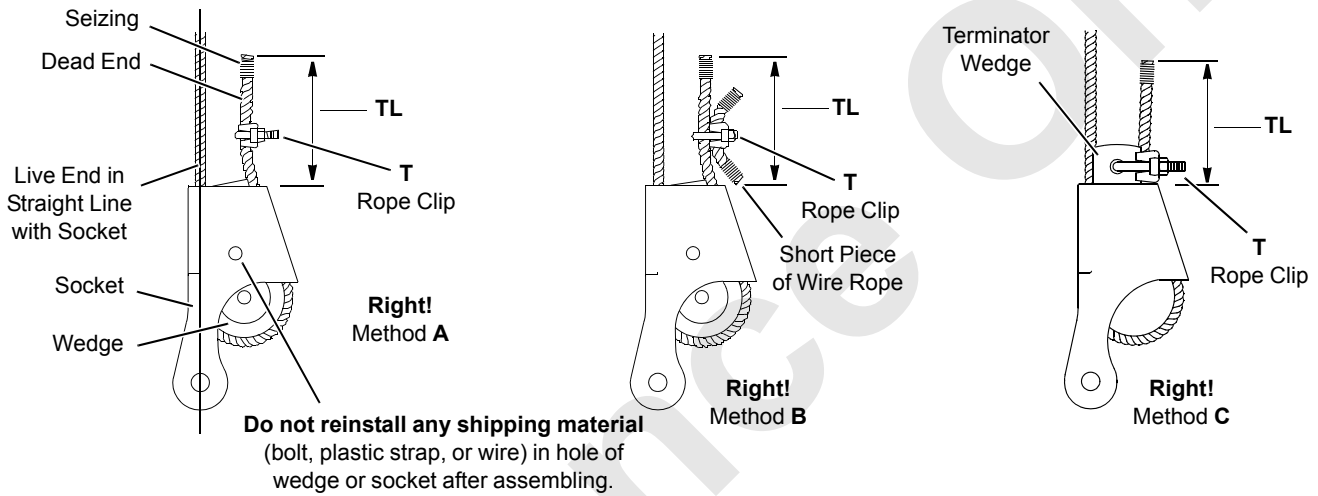

ALL ARE DANGEROUS AND PROHIBITED!

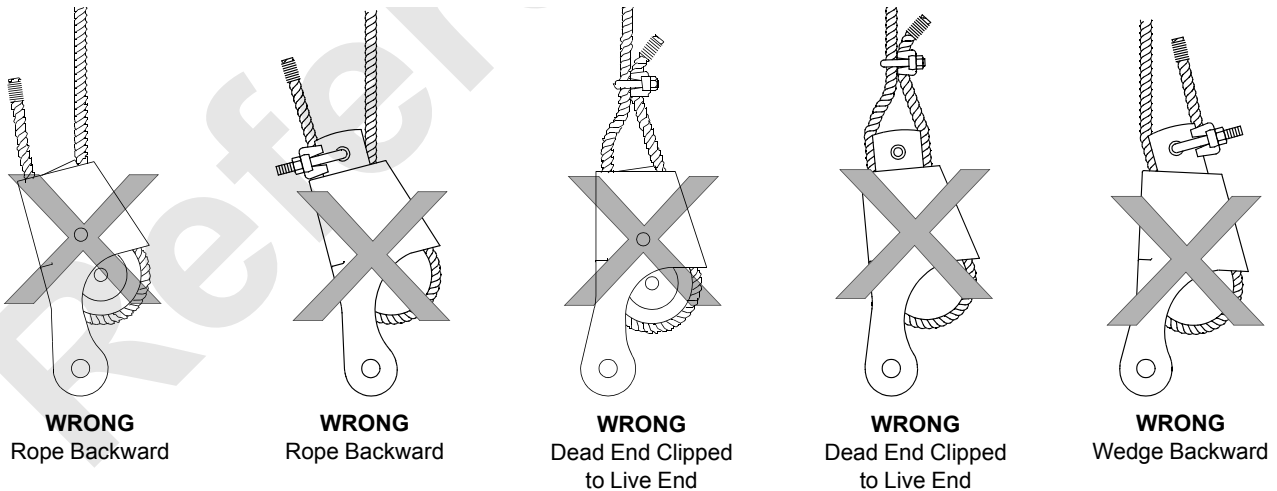

A925

FIGURE 4-38

Anchoring Wire Rope to Wedge Socket



WARNING

Falling Load Hazard!

- Inspect all parts prior to use. Do not use parts that are cracked or otherwise defective.
- Remove minor nicks, burrs, or rough edges from socket, wedge, or pin by lightly grinding. Do not reduce original dimensions by more than 10%.
- Do not reinstall shipping material (bolt, plastic strap or wire) in hole of wedge or socket after assembling. Discard these materials because they can prevent wedge from tightening in socket.
- Only use a wedge and socket which are correct size for wire rope being used. Do not mix and match parts from one assembly with parts from another assembly. Terminator™ socket and wedge has “go” and “no-go” holes to check for proper rope size.
- Attach wire rope clip to dead end of wire rope after assembling wire rope to wedge and socket.
- If dead end of wire rope is welded, seize end of wire rope and cut off weld before assembling to wedge and socket. Weld will not allow strands of wire rope to adjust around bend of wedge, resulting in high strands and wavy rope. This condition can seriously weaken attachment.

See [Figure 4-38](#) for the following procedure.

1. Assemble wire rope and wedge to socket so live end of wire rope is in a straight line with socket pin hole. **Do not assemble WRONG as shown.**
2. Allow dead end of wire rope to extend past end of socket amount shown.
3. Allow wire rope to assume its natural lay.
4. Pull against wedge and live end of wire rope enough to tighten wedge in socket.

Use a brass hammer to seat wedge and wire rope as deep into socket as possible.

5. Attach a wire rope clip to dead end of wire rope using one of the RIGHT methods shown. Rope clip will aid in preventing wire rope from being pulled out of socket.

NOTE: Use Right Method A only if wire rope clip is small enough to be securely tightened to dead end. Right Method C is only for a Terminator socket and wedge.

6. After socket is pinned in place, hoist load slowly so wedge seats tight. Do not shock load socket and wedge.

Anchoring Wire Rope to Button Socket



WARNING

Falling Load Hazard!

Wire rope can break if the following precaution is not observed:

- Do not attach dead end of wire rope to live end of wire rope with wire rope clip. Wire rope clip will transfer load from live side of wire rope to dead end, seriously weakening attachment.

See [Figure 4-39](#) for the following procedure.

1. Remove pin from socket.
2. Install button end of load line in socket.
3. Pin socket to anchor point.
4. Securely tighten locking screw.

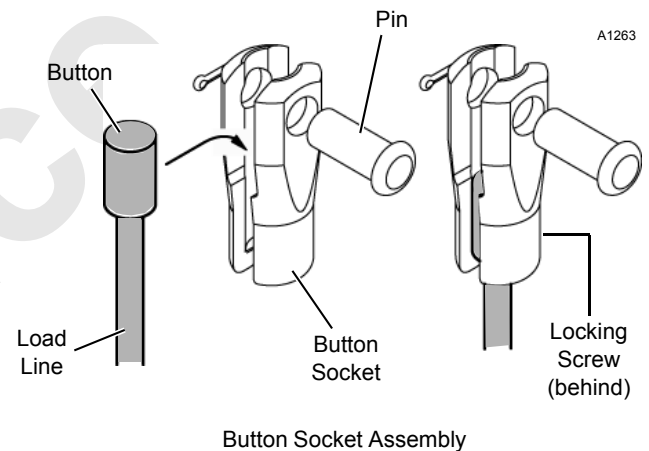

FIGURE 4-39

Breaking in Wire Rope

After installing a new wire rope, break it in by operating it several times under a light load and at reduced speed. This practice allows the wire rope to form its natural lay and the strands to seat properly.

NOTE: Wire rope will stretch during the break-in period, reducing the wire rope's diameter as the strands compact around the core.

The dead wraps of wire rope on the drum can become slack during operation, even if the utmost care is used during installation of the wire rope. This slackening is caused by the normal stretch that occurs in a new wire rope under tension and periodically throughout the wire rope's life from release of the load.

When slackness is noted, tightly wind the dead wraps of wire rope onto the drum. If left uncorrected, a wedging action with subsequent layers will occur, and the resultant abrasion may cause broken wires in the dead wraps.

DRUM KICKER ADJUSTMENT

General

A drum kicker (see [Figure 4-40](#)) is provided on both flanges of the main load drum (in boom butt) to improve wire rope spooling for long boom lengths with small fleet angles where the wire rope might stack up along either drum flange.

Observe the wire rope during initial break-in and periodically during operation. If the rope stacks up at either end of the drum, adjust the drum kickers.

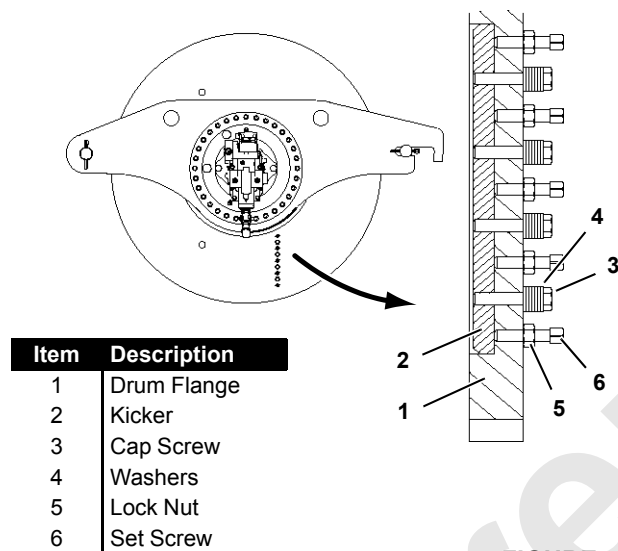

FIGURE 4-40

Adjustment

See [Figure 4-40](#) for the following procedure.

To move drum kickers (1) into the drum (take up space), proceed as follows:

1. Remove drum guard from both ends of drum.
2. Remove an equal number of washers (3) from both sides of kicker (1), one side at a time. Each washer allows kicker to move 0.098 in (2,5 mm).

3. Loosely reinstall cap screws (2) and remaining washers (3).
4. Loosen lock nuts (4) and adjust set screws (5) to move kickers (1) into drum.
5. Repeat steps 1-3 only enough to improve spooling. **Moving drum kickers in too far can cause premature wire rope wear.**
6. Securely tighten set screws (5) and lock nuts (4).
7. Reinstall drum guards.

PAD EYE USAGE FOR WIRE ROPE REEVING

See [Figure 4-41](#) for the following procedure.

General

Some rotation-resistant wire rope supplied by Manitowoc is equipped with a pad eye welded to the leading end of the wire rope or to the button on the end of the wire rope.

A rigging line can be attached to the pad eye to make it easier to reeve the load block.

Safety

1. Do not exceed approximate capacities listed in [Figure 4-41](#).
2. Make sure rigging line and attaching hardware (clips and rope connectors) are rated for the approximate capacities shown in [Figure 4-41](#).
3. Inspect pad eye prior to each use. **Replace it if:**
 - Any original dimensions have changed
 - Cracks or breaks exist in metal or weld



WARNING

Flying Part Hazard!

Pad eye on end of wire rope has been provided **for reeving purposes only**. Any other use is neither intended nor approved.

Pad eye can break and fly apart with considerable force if it is overloaded, not used properly, or not maintained properly.

A1189
A09310

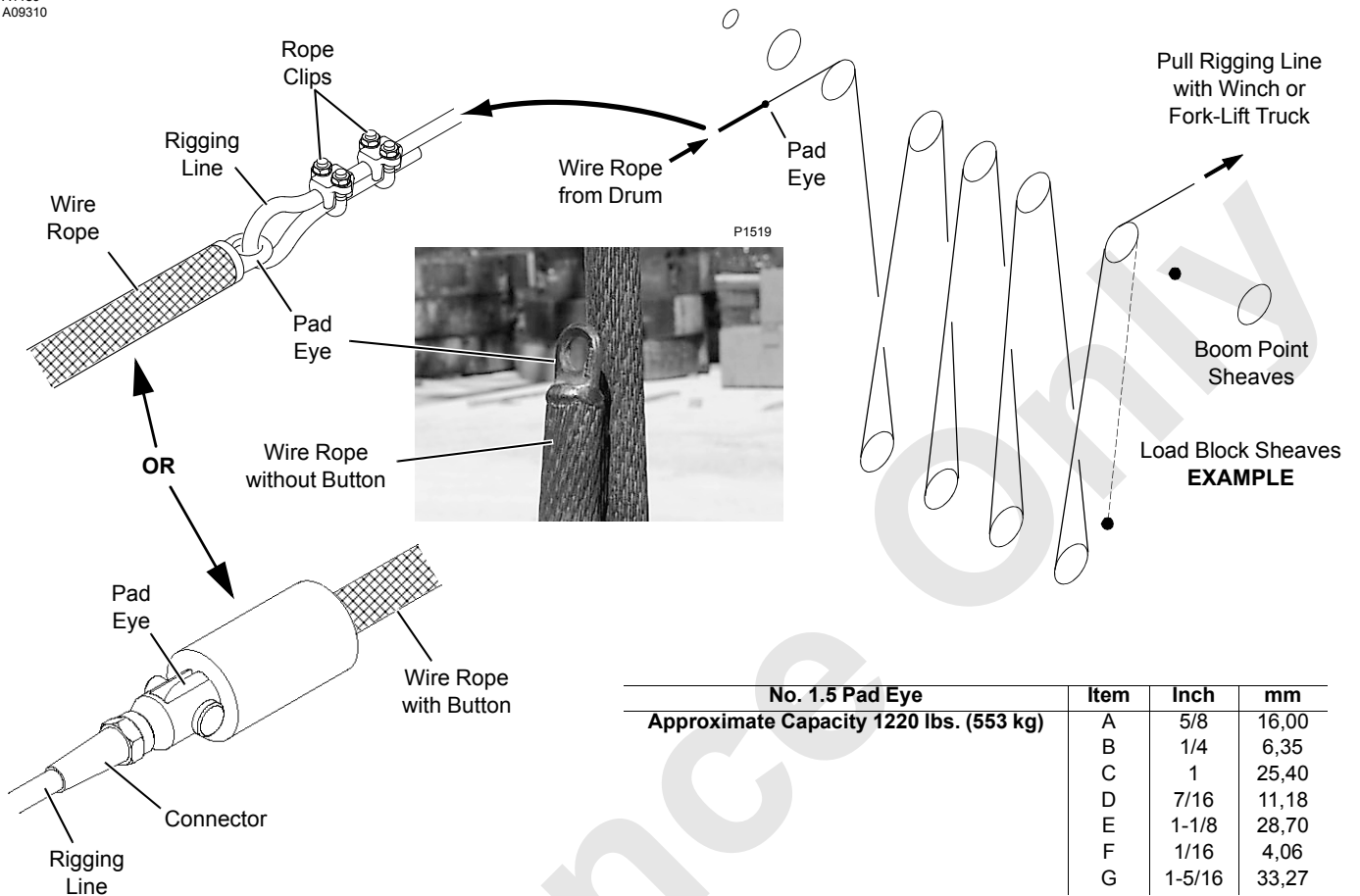

No. 1.5 Pad Eye			
Item	Inch	mm	
Approximate Capacity 1220 lbs. (553 kg)			
A	5/8	16,00	
B	1/4	6,35	
C	1	25,40	
D	7/16	11,18	
E	1-1/8	28,70	
F	1/16	4,06	
G	1-5/16	33,27	

No. 1 Pad Eye			
Item	Inch	mm	
Approximate Capacity 1220 lbs. (553 kg)			
A	3/8	9,65	
B	1/4	6,35	
C	7/8	22,40	
D	13/32	10,40	
E	7/8	22,40	
F	1/8	3,30	
G	1-1/32	25,40	

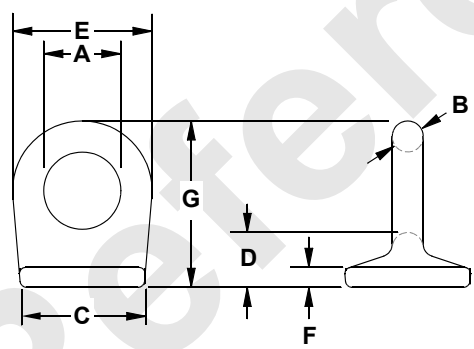

No. 2 Pad Eye			
Item	Inch	mm	
Approximate Capacity 2600 lbs. (1179 kg)			
A	3/4	19,05	
B	3/8	9,65	
C	1-1/16	26,92	
D	1/2	12,70	
E	1-1/2	38,10	
F	3/16	4,83	
G	1-5/8	41,26	

FIGURE 4-41

RIGGING WINCH OPERATION

If your crane is equipped with the optional rigging winch (Drum 0) see the Rigging Winch Assembly drawing at the end of this section for wire rope routing.

Selecting Rigging Winch Mode

See [Figure 4-42](#) and [Figure 4-43](#) in the following procedure.

TO TURN RIGGING WINCH MODE ON —

1. Go to Function Mode screen in main display.
2. In **level 2**, use the select buttons to enter selected drum screen options. Select rigging winch data box ([Figure 4-42](#)).

NOTE: The rigging winch data box will only appear if this feature is available.

3. In **level 3**, enter data box and use the select buttons to **turn ON** rigging winch.
4. The yellow box with “I” icon appears when winch is ON.

Rigging Winch Mode

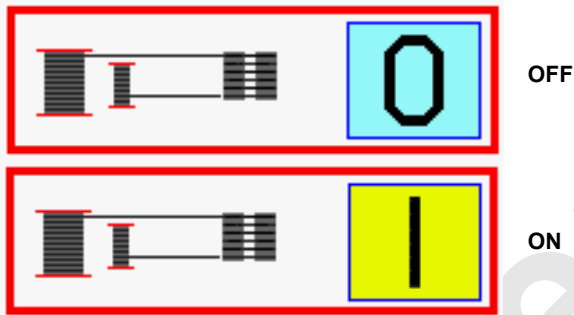

FIGURE 4-42

5. Drum 4 handle (boom hoist) will now control the rigging winch (Drum 0). “0” will appear in the indicator at the boom hoist handle.

TO TURN RIGGING WINCH MODE OFF —

1. Go to Function Mode screen in main display.
2. In **level 2**, use the select buttons to enter selected drum options screen. Select rigging winch data box ([Figure 4-42](#)).
3. In **level 3**, enter data box and use the select buttons to **turn OFF** rigging winch.

NOTE: The rigging mode will automatically turn OFF when power to the control system is turned off.

Operating Rigging Winch

Free-Spool Operation

The winch has a free-spool clutch which allows the drum barrel to be disconnected from the drive mechanism. This position allows the drum to be turned by hand.

Past Production [Figure 4-43](#):

TO TURN FREE-SPOOL ON —

1. Pull out locking pin (1) and hold.
2. Pull out knob (2).
3. Release locking pin (1).

TO TURN FREE-SPOOL OFF —

1. Pull out locking pin (1) and hold.
2. Push knob (2) in.
3. Release locking pin (1).

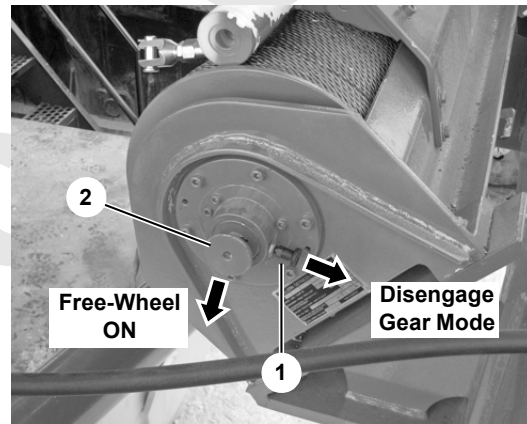

P2314

Item	Description
1	Locking Pin
2	Knob

FIGURE 4-43

Current Production [Figure 4-44](#):

TO TURN FREE-SPOOL ON —

1. Winch must be “at rest” and have no load on cable.
2. Rotate gear shifting lever (1) 90° up.

TO TURN FREE-SPOOL OFF —

1. Winch must be “at rest” and have no load on cable.
2. Rotate gear shifting lever (1) 90° down.

Current Production Rigging Winch

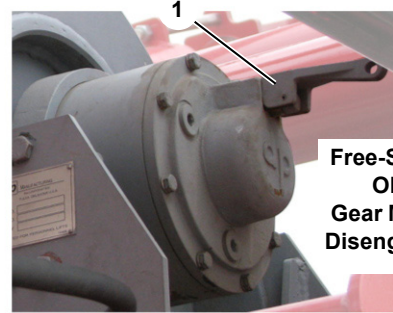
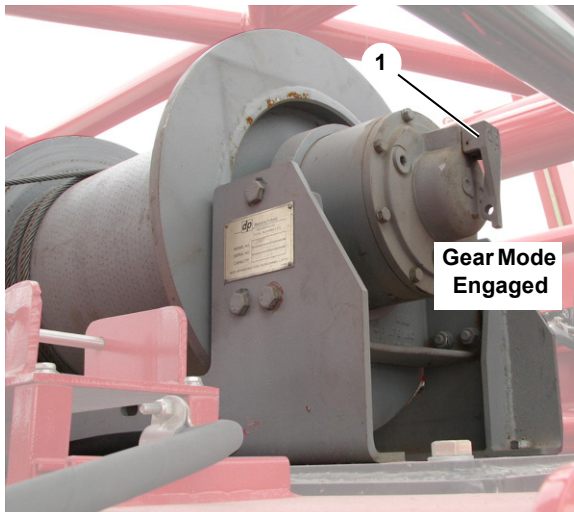

Item	Description
1	Gear Shifting Lever

M102484

FIGURE 4-44

Power Operation

1. Turn free spool off and engage gear mode.
2. Turn on rigging winch mode.
3. GEAR ENGAGEMENT — **slowly** rotate rigging winch 90° in pay out direction by moving Drum 0 control handle forward and then **stop** rotation. **Slowly** rotate drum approximately 90° in the pay in direction by pulling back on Drum 0 control handle to ensure gears are fully engaged.
4. Pay out rigging line by moving Drum 0 control handle forward.
5. Reeve rigging line through block and boom point and connect to desired load line as shown in Rigging Winch Assembly drawing at end of this section.
6. Use engine throttle to snug up rigging line prior to paying out load line from selected load drum. Faulty operation will result if there is slack in rigging line before engaging automatic part of operation.

NOTE: Use engine throttle to increase and decrease rigging winch line pull.

7. Use engine throttle speed to control line slack at rigging winch.
8. Move Drum 0 control handle to off and push corresponding load drum control handle forward to pay out load line. Rigging winch will haul in rigging line automatically.

NOTE: The stall line pull of the rigging winch is regulated with a proportional relief valve controlled by the crane's programmable controller.

CAUTION!

Avoid Rigging Winch or Wire Rope Damage!

Rigging winch will not automatically pay out line if selected load drum control handle is pulled back to hoist position.

Structural damage to winch or rigging line will occur!

If it is necessary to haul in load line on load drum when load line is connected to rigging line, proceed as follows:

- Pay out rigging line with Drum 0 control handle while hauling in load line with load drum control handle.
- Keep rigging line slacker than load line with engine throttle.

WARNING
Flying Object Hazard!

Do not attempt to disconnect rigging line from load line until lines are slack.

Lines could fly apart with explosive force and strike personnel.

9. Once load line is reeved through block and boom point:
 - a. Move load drum control handle to off.
 - b. Pay out rigging line to slacken load line by pushing Drum 0 handle forward.
 - c. Disconnect rigging line from load line.
 - d. Haul in rigging line for storage on rigging winch by pulling Drum 0 control handle back.

- e. Secure end of rigging line to boom for storage.
- f. Connect load line to dead-end socket. See instructions in this section.
- g. Turn OFF rigging winch mode.

REEVING – LOAD BLOCK

Load Block Identification

See the Boom Assembly Drawing at the end of this section for a complete list of load blocks and weight balls available for this crane.

WARNING Falling Load Hazard!

Use only a load block with a capacity equal to or greater than load to be handled.

Avoid overloading load block sheave bearings. Attach load to duplex hook so load hangs straight.

Load block can fail if overloaded, allowing load to fall.

Wire Rope Specifications

See Wire Rope Specifications chart in Capacity Chart Manual for the following load block reeving information:

- Parts of line required to handle desired load
- Wire rope length required for various boom lengths and parts of line
- Maximum spooling capacity of load hoists

Wire Rope Installation

See Wire Rope Lubrication in Section 5 for lubricating wire rope.

See [Wire Rope Installation](#) for instructions:

- Installing wire rope on drums
- Anchoring wire rope to drums

Duplex Hook

Attach the load so it is balanced equally on the hook. Lifting slings must be within angles given in [Figure 4-45](#) to achieve maximum hook capacity. The duplex hook has a hole to which an optional shackle can be attached as shown in [Figure 4-45](#).

WARNING Falling Load Hazard!

Limit load to be handled with shackle to capacity of load block or shackle, whichever is less.

Load block or shackle can fail if overloaded, allowing load to fall.

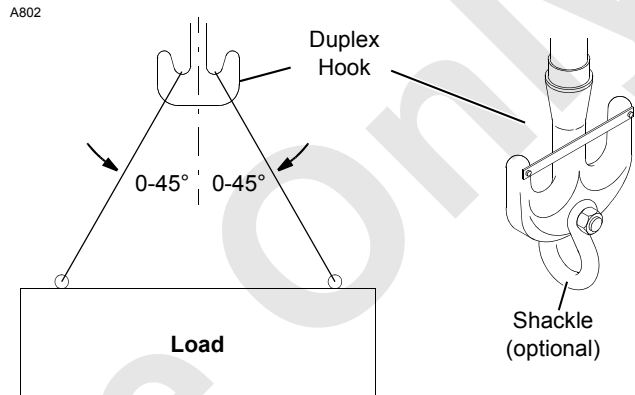

FIGURE 4-45

Guide Sheaves and Drums

See [Figure 4-46](#) for identification of the load drums and guide sheaves.

Once wire rope is routed through the guide sheaves, be sure to install rope guard pins, bars, and rollers to retain the wire rope on the sheaves. **Wire rope and sheaves can be damaged if rope is not properly retained on sheaves.**

Load Block Reeving

See [Figure 4-47](#) and [Figure 4-48](#) for dead-end locations and components in the lower and upper boom points.

See [Figure 4-49](#) for load block reeving. Reeving the load block in any manner other than shown can result in excessive block twist.

CAUTION

Wire Rope Damage!

Do not hoist load block closer to boom point than shown on Range Diagram in Capacity Chart Manual. Improper fleet angle or contact with other parts can damage wire rope.

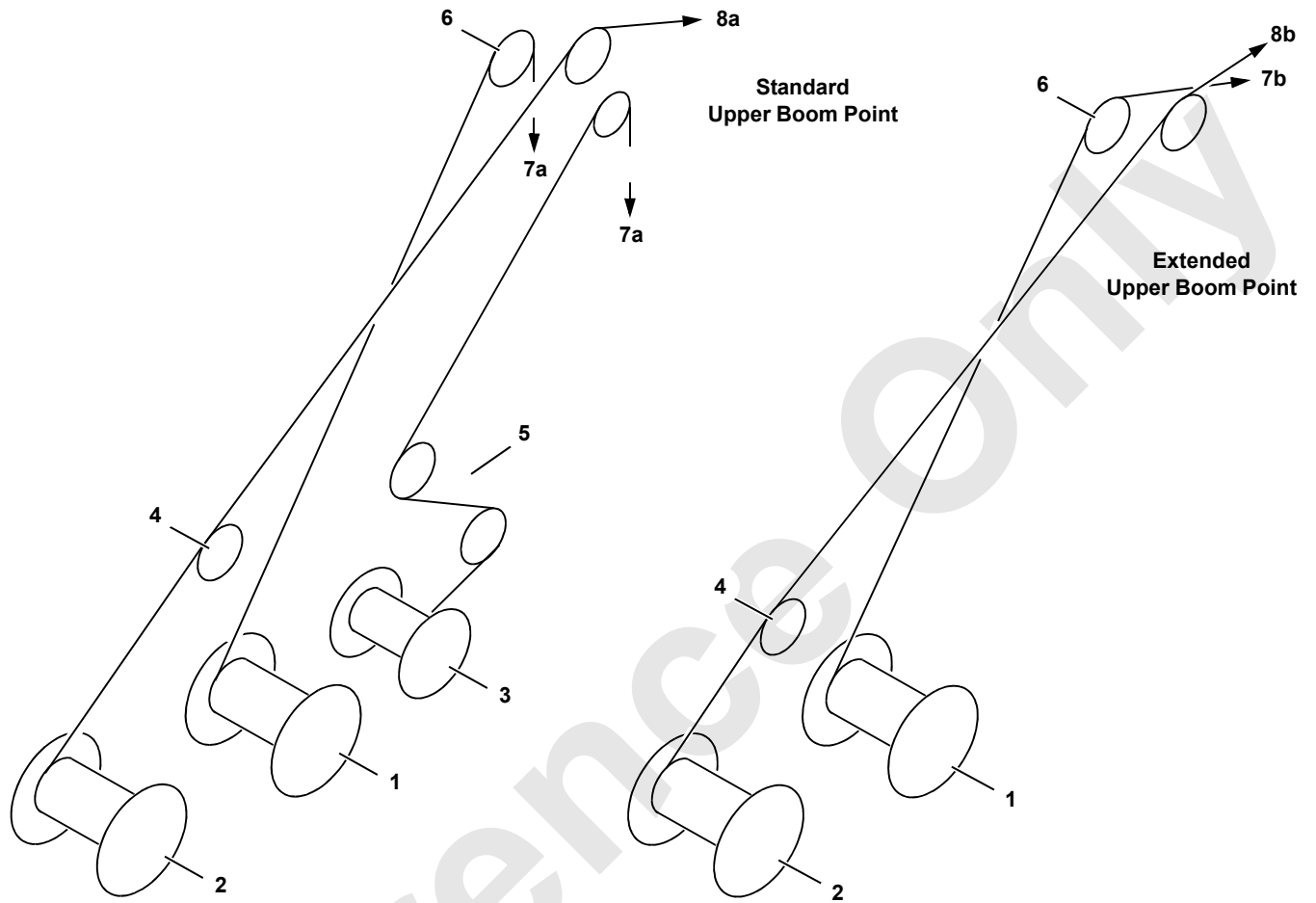

Item	Description
1	Main Hoist (Drum 1 in boom butt)
2	Whip Hoist (Drum 2 in crane)
3	Auxiliary Hoist (Drum 3 in boom butt)
4	Wire Rope Guide (on boom butt)
5	Wire Rope Guides (in insert)
6	Wire Rope Guide (on boom top)
7a	To Lower Boom Point
7b	To Extended Upper Boom Point (lower sheaves)
8a	To Standard Upper Boom Point
8b	To Extended Upper Boom Point (upper sheave)

NOTE: See Wire Rope Specifications Chart for line pull of drums. Drums 2 and 3 do not have same line pull as Drum 1.

Drum 2 has a high-speed option. This option does not increase line pull – only speed. High-speed is approximately 80% faster than standard speed (depending on load and layer).

FIGURE 4-46

A08493

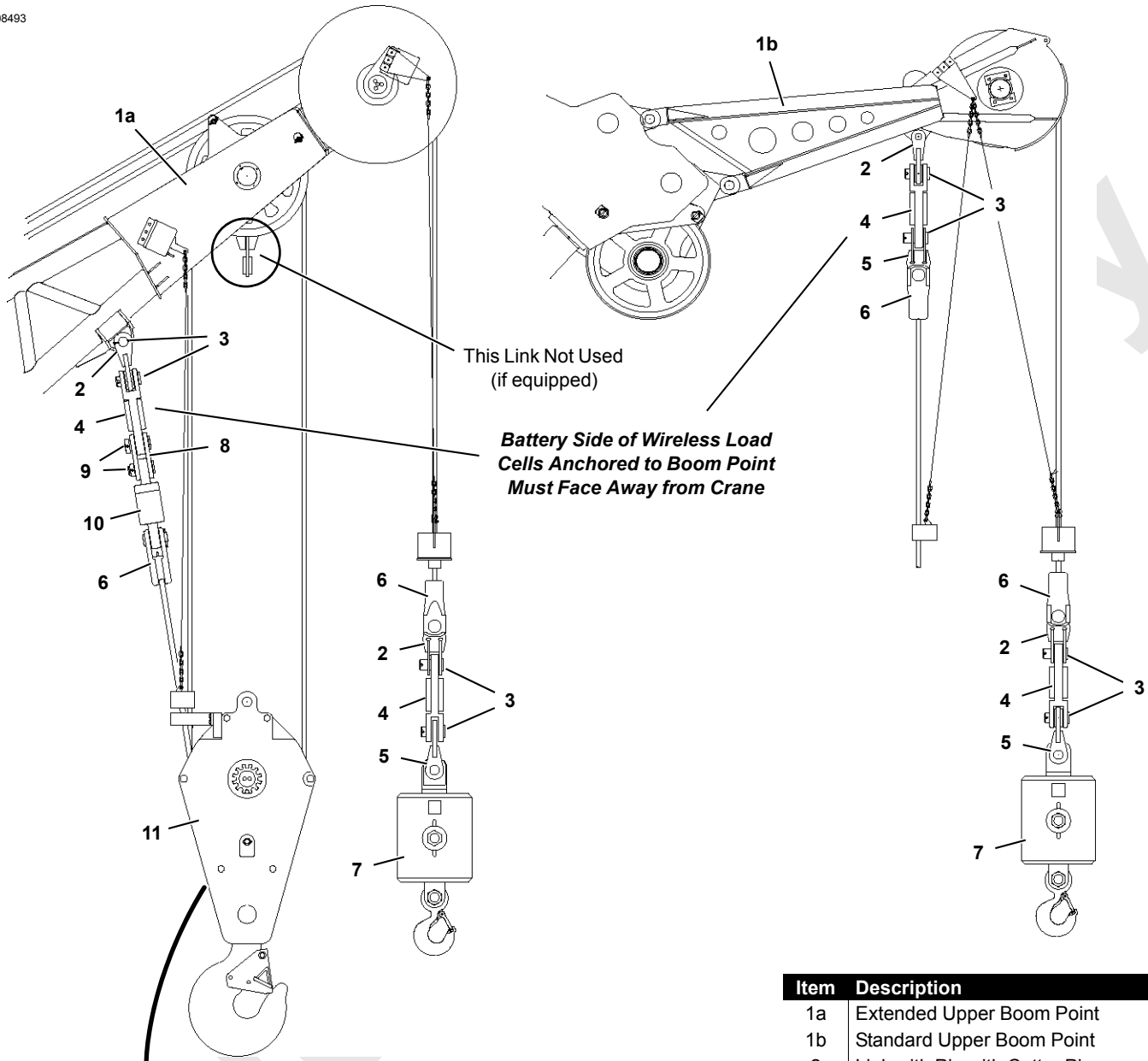

! WARNING

Avoid Death or Serious Injury!

Exercise care when block is standing in vertical position, as the potential for tipping exists. Potential causes of tipping are unstable work area, boom movement and the reeving process. If work area is unstable, lay block flat on side plate.

Item	Description
1a	Extended Upper Boom Point
1b	Standard Upper Boom Point
2	Link with Pin with Cotter Pin
3	Pin with Cotter Pin
4	Load Cell – 35,000 lb (13 063 kg)
5	Link
6	Button Socket – 1-1/8 in (28 mm) with Pin and Cotter Pin
7	Weight Ball
8	Links
9	Pin with Collar, Retaining Pin, and Cotter Pins
10	Swivel
11	Load Block

Figure 4-47



A11388

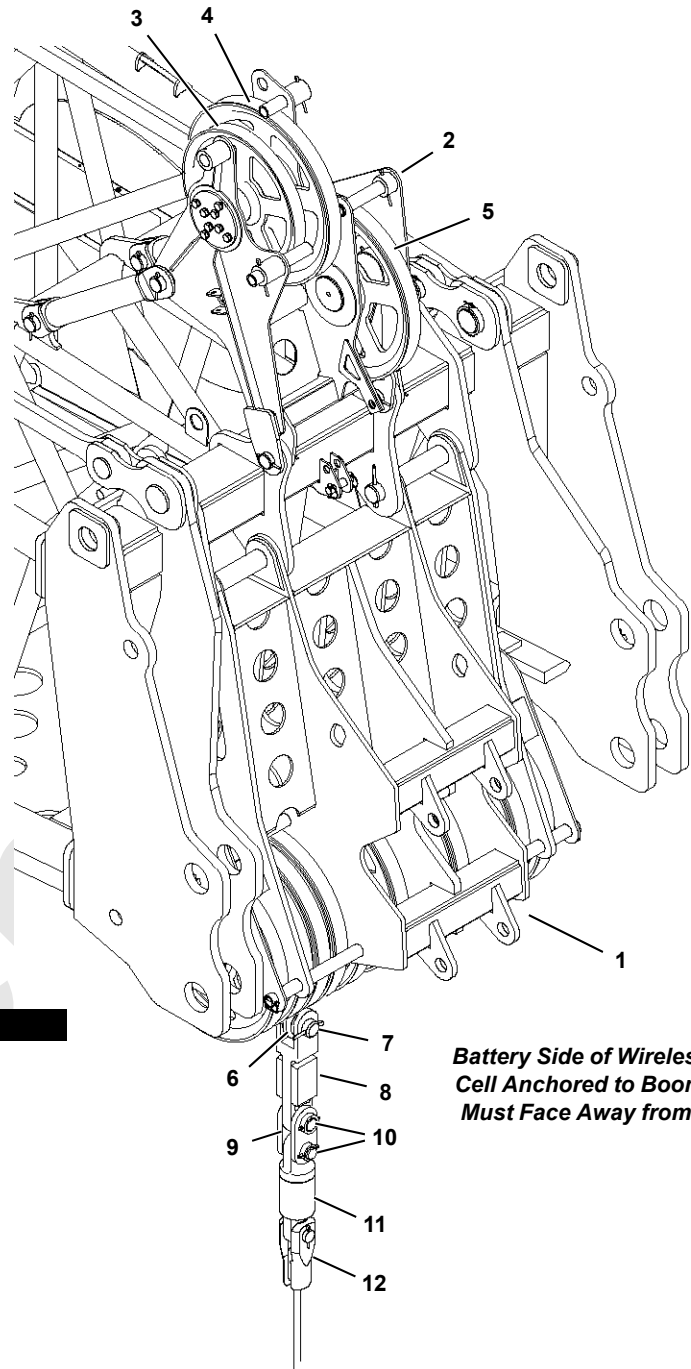

Item	Description
1	Lower Boom Point
2	Wire Rope Guide (on boom top)
3	Luffing Hoist Guide Sheave
4	Whip Hoist Guide Sheave
5	Main Hoist Guide Sheave
6	Dead-End Link
7	Pin with Cotter Pin
8	Load Cell – 35,000 lb (13 063 kg)
9	Links
10	Pin with Collar, Retaining Pin, and Cotter Pins
11	Swivel
12	Button Socket – 1-1/8 in (28 mm) with Pin and Cotter Pin

Battery Side of Wireless Load Cell Anchored to Boom Point Must Face Away from Crane

4

FIGURE 4-48

Reeving_1

LOWER BOOM POINT REEVING

Item	Description
1	Boom Top Guide Sheaves
2	Lower Boom Point
3	Load Block
4	Standard Upper Boom Point
●	Dead-End Socket
■	Two-Block Weight

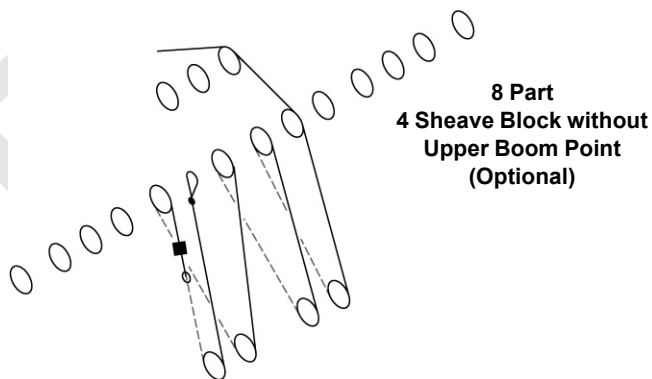
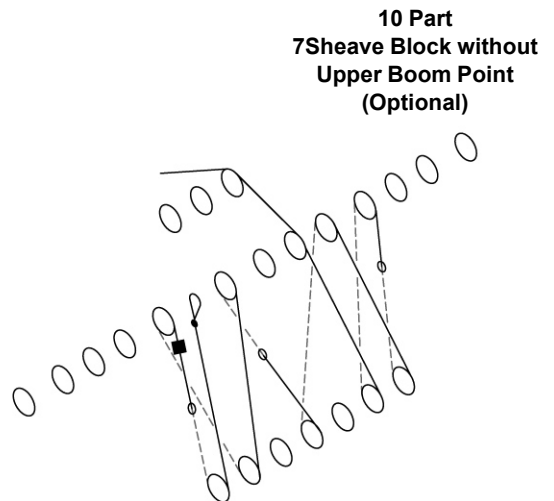
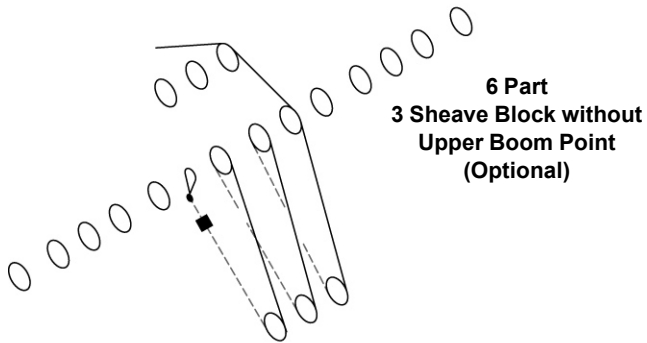
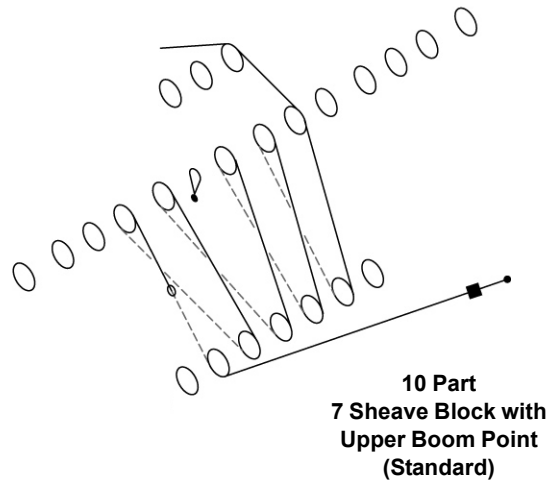
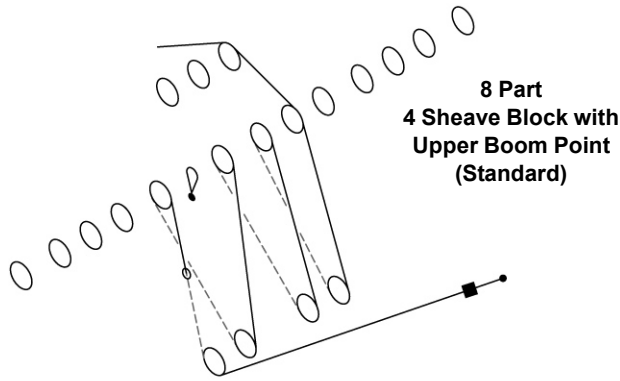
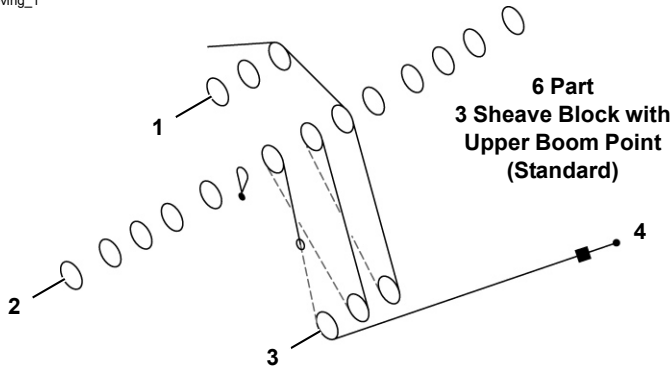

FIGURE 4-49

Reeving_2

**LOWER BOOM
POINT REEVING**

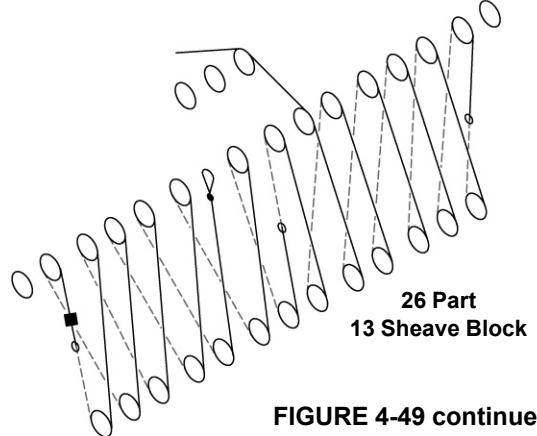
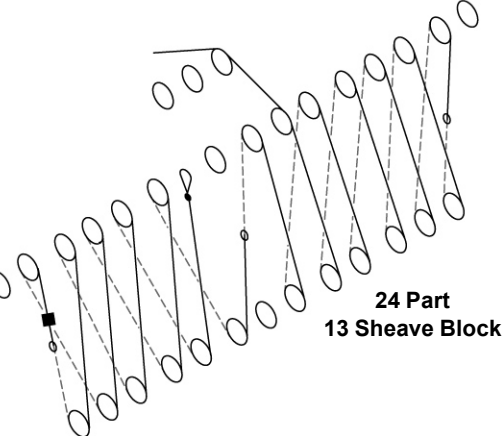
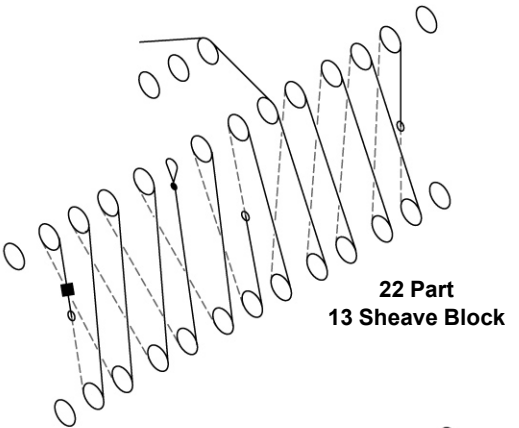
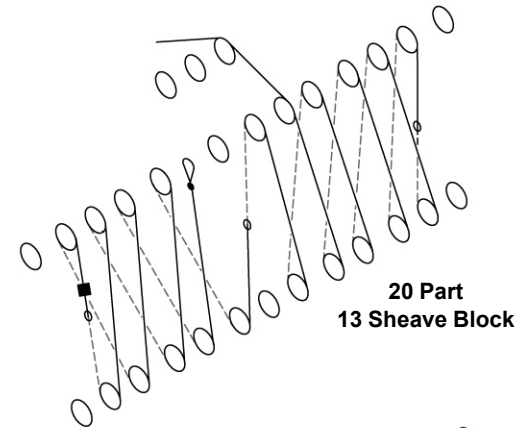
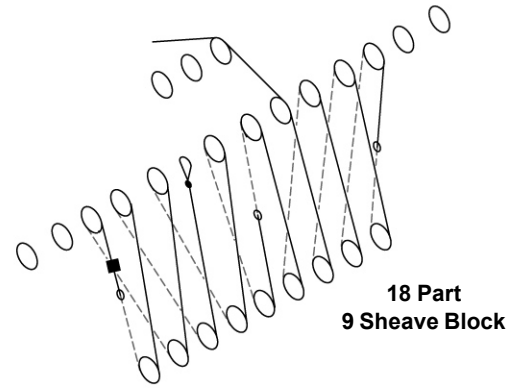
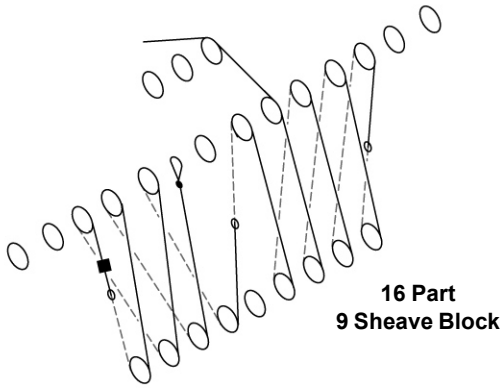
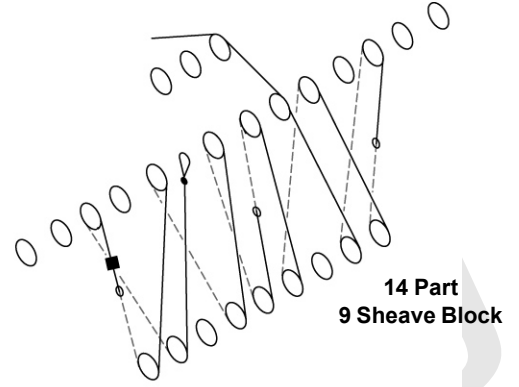
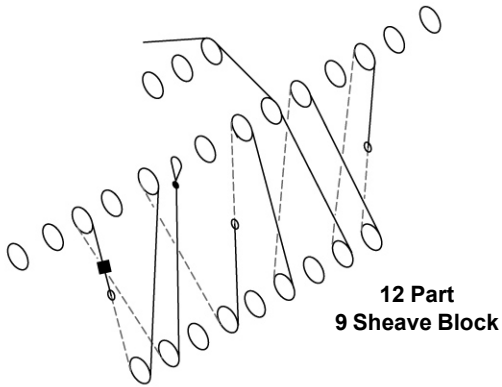

FIGURE 4-49 continued

Item	Description
1	Boom Top Guide Sheaves
2	Extended Upper Boom Point (lower sheaves)
3	Load Block
●	Dead-End Socket
■	Two-Block Weight

**EXTENDED BOOM POINT REEVING
(Lower Sheaves)**

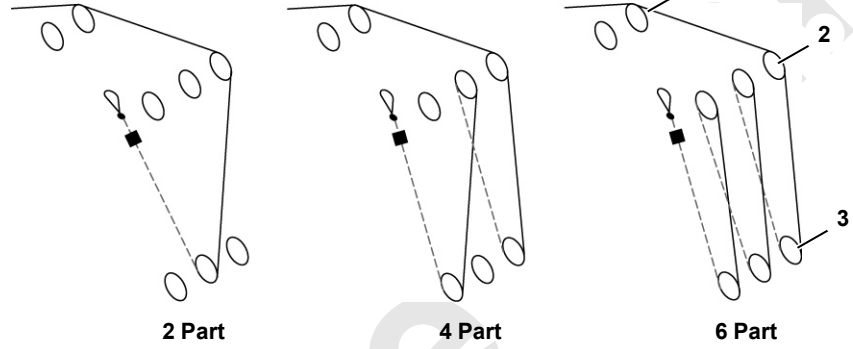

FIGURE 4-50

REEVING – LIVE MAST

General

The live mast wire rope must be reeved between Drum 4 and the mast hoist sheaves as shown in [Figure 4-51](#).

Use **Manitowoc #15836 wedge** for anchoring the wire rope to the drum sockets.

Wire Rope Specification

Manitowoc recommends the following wire rope for the live mast:

Manitowoc #A05680 —

1,620 ft (494 m), 1-1/8 in (28,6 mm) diameter
 Minimum Breaking Strength 159,000 lb (707 kN)

Rope diameter at no load:

- 1.160 in (29,46 mm) maximum
- 1.136 in (28,85 mm) minimum

A10595

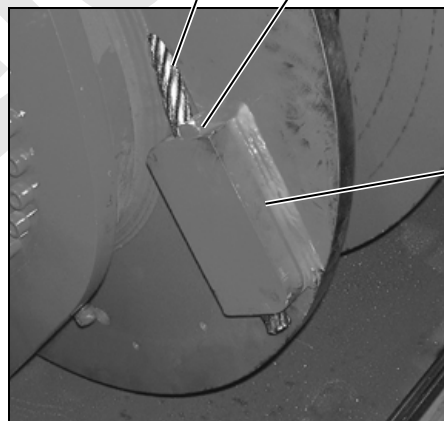
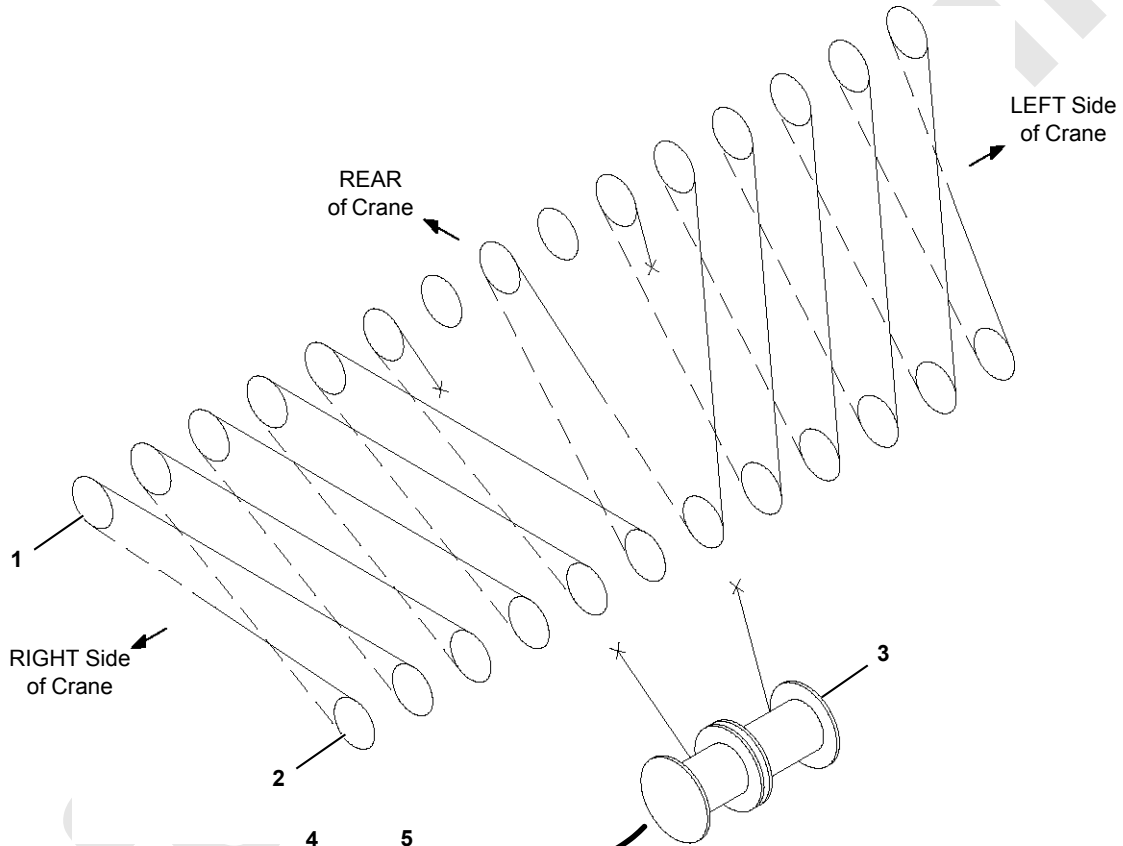

P2280

Item	Description
1	Sheave Cluster at End of Mast
2	Sheave Cluster at Rear of Rotating Bed
3	Boom Hoist (Drum 4)
4	Wire Rope
5	Wedge, 1-1/8 in (28 mm)
6	Drum Socket

FIGURE 4-51

THIS PAGE INTENTIONALLY LEFT BLANK

**SECTION 5
LUBRICATION**

TABLE OF CONTENTS

Lubrication5-1

Reference Only

THIS PAGE INTENTIONALLY LEFT BLANK

Reference Only

SECTION 5 LUBRICATION

LUBRICATION

See F2109 at the end of this section.

Reference Only

THIS PAGE INTENTIONALLY LEFT BLANK

Reference Only

SECTION 6 MAINTENANCE CHECKLIST

TABLE OF CONTENTS

Inspection and Maintenance Checklist	6-1
Fiberglass Maintenance	6-1

Reference Only

THIS PAGE INTENTIONALLY LEFT BLANK

Reference Only

SECTION 6 MAINTENANCE CHECKLIST

INSPECTION AND MAINTENANCE CHECKLIST

See F2097 at the end of this section.

FIBERGLASS MAINTENANCE

See Bulletin W04-009 at the end of this section.

Reference Only

THIS PAGE INTENTIONALLY LEFT BLANK

Reference Only

ALPHABETICAL INDEX

Assembling, Disassembling, or Operating Crane Near Electric Power and Transmission Lines	2-16
Accessing Parts	4-2
Accidents	2-18
Assembly And Disassembly Area	4-2
Assembly and Disassembly Notes	4-2
Assist Crane Requirements	4-2
Boom Disassembly Safety	2-23
Boom Ladder Assembly	4-45
Boom Rigging	4-46
Cab Door Damper Adjustment	3-11
Change of Ownership Registration	1-1
Circuit Breakers	3-77
Cold Weather Heater Package	3-76
Cold Weather Mast Operation	4-3
Continuous Innovation	2-1
Controls Identification And Function	3-13
Crane Access Points	2-5
Crane Assembly	4-8
Crane Data	1-1
Crane Disassembly	4-37
Crane Orientation	1-1
Crane Orientation	4-1
Crane Weights	4-2
Crane/Attachment Identification	1-1
Current Production Cold Weather Package	3-79
Displays	3-48
Drum Kicker Adjustment	4-68
English and Metric Conversions	1-4
Environmental Protection	2-20
Fiberglass Maintenance	6-1
Fire Extinguishers	2-18
Front Window Operation	3-10
General Safety	4-1
Getting On or Off Crane	2-5
Handling Components	4-3
Hose and Cable Cleanliness	4-3
Identification and Location of Components	1-2
Inspection and Maintenance Checklist	6-1
Introduction	1-1
Liftcrane Mast Capacities	4-1
Limit Devices	3-28
Lubrication	5-1
Lubrication	5-1
Luffing Jib Setup Mode	3-23
Maintenance Checklist	6-1
Manitowoc Dealer	1-1
Nameplates and Decals	2-1
Node-6 Configuration with Mast Stop Limit Switch	4-36
Operating Controls And Procedures	3-1
Operating Controls	3-10
Operating Controls	4-6
Operation	3-32
Operational Aids	2-14

Operator Manual/Capacity Chart Storage	2-6
Optional Attachments	4-1
Pad Eye Usage for Wire Rope Reeving	4-68
Past Production Cold Weather Package	3-78
Pedestal/barge Mounted Cranes	2-26
Personnel Handling Policy	2-24
Pin and Connecting Hole Cleanliness	4-3
Preparation for Cold Weather	3-75
Preparing Crane for Operation	3-31
Pre-Start Checks	4-7
Reeving – Live Mast	4-79
Reeving – Load Block	4-72
Refueling	2-18
Remote Controls	3-41
Retaining Connecting Pins	4-3
Rigging Drawings	4-1
Rigging Winch Operation	4-70
Safe Maintenance	2-18
Safe Operating Practices	2-8
Safety and Information Signs	2-3
Safety Devices	2-14
Safety Information	2-1
Safety Messages	2-1
Seat Controls	3-30
Self-Erecting Equipment	4-1
Set-Up and Installation	4-1
Shipping Crane Components	4-6
Signals	2-13
Standard Hand Signals for Controlling Crane Operations	3-2
Starting Crane Engine	4-7
Stopping Engine/ Leaving Crane Unattended	3-40
Symbol Identification	3-4
Wind Conditions	3-73
Wire Rope Installation	4-62

