

# Liftcrane Luffing Jib Capacities

Luffing Jib No. LJ11:680-681-682 on  
 Boom No. B65:685-680  
 with Mast No. M11:684  
 440,900 lb VPC (Variable Position Counterweight)  
 360 Degree Rating

**MLC650  
 VPC-MAX  
 SERIES 1**



**LIFTING CAPACITIES:** Lifting capacities for various boom lengths, boom angles, luffing jib lengths, and luffing jib operating radii are for freely suspended loads and may be based on percent of static tipping or strength of structural components. Capacities must be reduced by applicable deducts.

Upper luffing jib point capacity for liftcrane service with single part whip line from Drum 3 is 30,000 lb or 60,000 lb with two part whip line. When Drum 1 or Drum 2 is used, capacity with single part whip line is 48,800 lb, or 73,500 lb with two part whip line. In all cases, upper luffing jib point capacities cannot exceed those listed for main luffing jib capacity.

Weight of all load blocks, hooks, weight ball, slings, hoist lines, etc., beneath boom and luffing jib point sheaves is considered part of load. Boom and luffing jib are not to be lowered beyond radii where combined weights are greater than rated capacity. Operation is only approved for boom and luffing jib angle range shown in capacity chart.

**LUFFING JIB BACKWARD STABILITY:** Capacities indicated by (b) require 14,000 lb minimum weight suspended beneath luffing jib point, (c) require 28,000 lb minimum weight, and (d) require 40,000 lb minimum weight. **Caution: Do not luff into areas indicated by (b), (c), or (d) without required minimum weight.** *Luffing jib may not luff down and luffing jib hoist wire rope may go slack. Luffing jib hoist wire rope may overhaul luffing jib and cause wire rope damage or failure.*

**OPERATING CONDITIONS:** Machine to operate on a firm, level, and uniformly supporting surface. Supporting surface and bearing turntable are to be level within a tolerance of 1/2 in. in 10 ft. Refer to Luffing Jib Rigging **No. 84038308**, Mast Rigging **No. 84050187**, Wire Rope Specifications chart **No. 9539-A**, Counterweight Arrangements chart **No. 9349-A**, Luffing Jib Raising Procedure chart **No. 9536-A**, and Wind Conditions chart **No. 9538-A**. Crane operator judgment must be used to allow for dynamic load effects of swinging, hoisting or lowering, travel, wind conditions, as well as adverse operating conditions and physical machine depreciation. Refer to the Operator Manual for operating guidelines.

**MACHINE TRAVEL:** Machine to travel on a firm, level, and uniformly supporting surface. Boom and luffing jib must be within angle range shown in capacity chart. Refer to Maximum Allowable Travel Specifications chart **No. 9537-A**.



**OPERATING RADIUS:** Operating radius is horizontal distance from axis of rotation to center of vertical hoist line or load block. Boom angle and luffing jib angle are an indication of operating radius. In all cases, operating radius shall govern capacity.



**BOOM ANGLE:** Boom angle in degrees (°) is angle between horizontal and centerline of boom butt and inserts.



**LUFFING JIB ANGLE:** Luffing jib angle in degrees (°) is angle between horizontal and centerline of luffing jib butt and inserts.

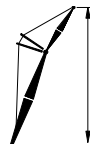

**LUFFING JIB POINT ELEVATION:** Luffing jib point elevation is vertical distance from ground level to centerline of luffing jib point shaft.

**MACHINE EQUIPMENT:** Machine equipped with VPC-MAX, 36 ft 6 in. crawlers, 60 in. or 80 in. treads, 36 ft 1 in. live mast, 118.1 ft mast, 16 part boom hoist reeving, boom support straps, 20 part luffing jib hoist reeving, luffing jib and backstay support straps, and 440,900 lb VPC.

Select counterweight position from Luffing Jib Raising Procedure chart **No. 9536-A** that will allow raising and lowering of boom and luffing jib length. Counterweight position selection may be changed with luffing jib on ground or while luffing jib is within operating range of capacity chart.

**Explanation of Symbols**



Luffing Jib No. LJ11:680-681-682  
+  
Boom No. B65:685-680



VPC (Variable Position Counterweight)



360 Degree Rating



Boom Length

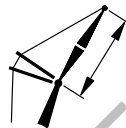

Luffing Jib Length



Boom Angle  
(see page 1)

**Explanation of Symbols**  
(continued)



Operating Radius  
(see page 1)



Luffing Jib Angle  
(see page 1)

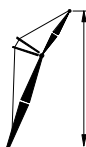

Luffing Jib Elevation  
(see page 1)

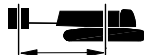

Counterweight Position  
from Axis of Rotation



Lifting Capacities  
(see page 1)

REFERENCE ONLY!

# MLC650 VPC-MAX S-1

ASME B30.5

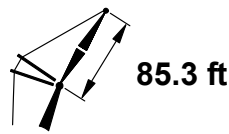
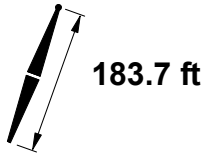

ft	85°				83°				80°				ft
	ft	ft	lb	lb	ft	lb	lb	ft	lb	lb			
55	71.9	273.2	455,100 c	749,700 c									55
60	68.2	271.1	409,900 c	681,100 c	72.9	273.0	392,100 c	666,700 c					60
65	64.5	268.6	372,200 c	617,300 c	69.3	270.9	355,900 c	604,200 c					65
70	60.6	265.7	340,100 b	564,000 b	65.5	268.5	325,200 b	552,000 b					70
75	56.5	262.2	312,600 b	518,700 b	61.7	265.7	298,800 b	507,700 b	68.9	269.1	278,200 b	491,200 b	75
80	52.2	258.2	288,600	479,900	57.7	262.4	275,900 b	469,600 b	65.2	266.7	256,700 b	454,300 b	80
85	47.6	253.6	267,600	446,100	53.5	258.6	255,800	436,500	61.3	263.8	237,900 b	422,300 b	85
90	42.6	248.0	248,900	416,400	49.0	254.2	237,900	407,400	57.3	260.5	221,200 b	394,100 b	90
95	37.1	241.4	232,200	390,100	44.1	248.9	221,900	381,700	53.0	256.6	206,300	369,300	95
100	30.5	233.0	217,000	366,700	38.7	242.6	207,500	358,800	48.5	252.1	192,900	347,100	100
105	22.0	221.4	202,900	345,500	32.4	234.8	194,300	338,200	43.6	246.7	180,800	327,200	105
110					24.7	224.3	182,200	319,500	38.1	240.3	169,700	309,200	110
115					12.0	206.1	170,300	302,300	31.8	232.3	159,400	292,800	115
120									23.8	221.5	149,700	277,800	120
125									9.6	201.0	140,000	263,700	125
130													130
135													135
140													140
145													145
150													150
155													155
160													160
165													165
170													170

# MLC650 VPC-MAX S-1

ASME B30.5

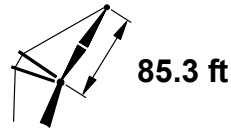
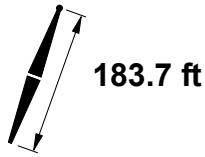

ft	75°				70°				65°				ft
	ft	ft	lb	lb	ft	ft	lb	lb	ft	ft	lb	lb	
55													55
60													60
65													65
70													70
75													75
80													80
85													85
90													90
95													95
100	61.8	260.5	168,400 b	327,800 b									100
105	57.8	257.2	157,700 b	309,000 b									105
110	53.6	253.4	147,900	292,000									110
115	49.1	249.0	139,000	276,600									115
120	44.2	243.7	130,700	262,500	58.0	252.3	111,200	247,200					120
125	38.9	237.5	123,100	249,600	53.8	248.5	104,500	235,100					125
130	32.7	229.7	115,900	237,700	49.3	244.1	98,400	223,900					130
135	25.0	219.4	109,100	226,600	44.5	238.9	92,600	213,600					135
140	12.6	201.7	102,100	216,100	39.1	232.7	87,200	204,000	53.6	241.9	71,300	191,700	140
145					33.0	225.0	82,100	195,000	49.1	237.4	67,000	183,300	145
150					25.4	214.9	77,100	186,600	44.2	232.2	62,900	175,500	150
155					13.6	198.0	71,900	178,500	38.8	225.9	59,000	168,100	155
160									32.7	218.2	55,200	161,200	160
165									24.9	207.8	51,500	154,600	165
170									12.6	190.2	47,400	148,100	170

# MLC650 VPC-MAX S-1

ASME B30.5

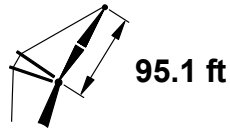
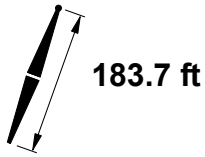

ft	85°				83°				80°				ft
	ft	lb	lb	lb	ft	lb	lb	lb	ft	lb	lb	lb	
55	73.8	283.7	452,600 c	741,500 c									55
60	70.6	281.8	407,500 c	677,200 c									60
65	67.3	279.6	369,800 b	613,800 b	71.5	281.6	353,200 b	600,500 b					65
70	64.0	277.1	337,800 b	560,800 b	68.3	279.5	322,600 b	548,600 b					70
75	60.5	274.1	310,400 b	515,800 b	64.9	277.0	296,300 b	504,600 b					75
80	56.8	270.8	286,600	477,100	61.5	274.2	273,500 b	466,700 b	67.9	277.7	253,800 b	451,200 b	80
85	53.0	266.9	265,700	443,500	57.9	270.9	253,400	433,800	64.6	275.2	235,100 b	419,300 b	85
90	49.0	262.4	247,100	414,000	54.1	267.2	235,700	404,900	61.1	272.3	218,600 b	391,300 b	90
95	44.7	257.3	230,600	387,900	50.2	263.0	219,900	379,400	57.5	269.0	203,800	366,600	95
100	40.0	251.3	215,700	364,700	45.9	258.0	205,600	356,600	53.7	265.2	190,500	344,600	100
105	34.7	244.0	202,100	343,800	41.3	252.3	192,700	336,200	49.8	260.9	178,500	324,800	105
110	28.5	235.0	189,700	324,900	36.2	245.4	181,000	317,700	45.5	255.9	167,600	307,000	110
115	20.4	222.5	178,000	307,600	30.3	237.0	170,100	300,900	40.9	250.1	157,600	290,800	115
120					22.9	225.7	159,900	285,500	35.7	243.1	148,300	276,000	120
125					10.5	205.7	149,800	271,200	29.7	234.4	139,700	262,400	125
130									22.1	222.8	131,500	249,800	130
135									7.9	199.9	123,000	237,900	135
140													140
145													145
150													150
155													155
160													160
165													165
170													170
175													175
180													180

# MLC650 VPC-MAX S-1

ASME B30.5

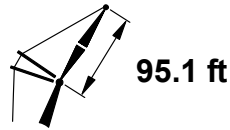
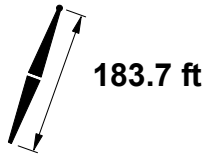

ft	75°				70°				65°				ft
	ft	°	ft	lb	ft	°	ft	lb	ft	°	ft	lb	
55													55
60													60
65													65
70													70
75													75
80													80
85													85
90													90
95													95
100													100
105	61.6	268.9	154,700	306,200									105
110	58.0	265.7	145,000	289,300									110
115	54.2	262.0	136,200	274,000									115
120	50.3	257.7	128,100	260,100									120
125	46.1	252.8	120,700	247,300	58.2	260.8	101,400	232,400					125
130	41.5	247.1	113,700	235,600	54.4	257.1	95,400	221,300					130
135	36.4	240.3	107,200	224,700	50.5	252.9	89,800	211,100					135
140	30.5	231.9	101,100	214,600	46.3	248.0	84,600	201,700					140
145	23.2	220.8	95,100	205,100	41.7	242.3	79,600	192,800	54.2	250.5	63,800	180,700	145
150	11.1	201.4	89,000	196,000	36.7	235.6	74,900	184,600	50.3	246.2	59,800	173,000	150
155					30.8	227.3	70,500	176,900	46.1	241.3	56,100	165,700	155
160					23.6	216.3	66,100	169,600	41.5	235.6	52,500	159,000	160
165					12.1	197.9	61,500	162,400	36.4	228.8	49,100	152,600	165
170									30.5	220.4	45,800	146,500	170
175									23.2	209.2	42,500	140,700	175
180									11.1	189.9	38,900	135,000	180

# MLC650 VPC-MAX S-1

ASME B30.5

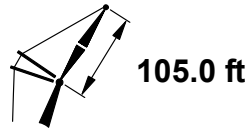
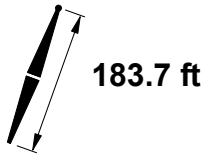

ft	85°				83°				80°				ft
	ft	lb	lb	lb	ft	lb	lb	lb	ft	lb	lb	lb	
60	72.5	292.3	406,200 b	674,200 b									60
65	69.6	290.4	368,500 b	611,200 b									65
70	66.6	288.1	336,700 b	558,500 b	70.4	290.2	321,200 b	546,100 b					70
75	63.5	285.5	309,300 b	513,700 b	67.4	288.0	295,000 b	502,300 b					75
80	60.4	282.6	285,600	475,200	64.4	285.5	272,200 b	464,700 b					80
85	57.1	279.3	264,700	441,800	61.3	282.7	252,300	431,900	67.2	286.2	233,600 b	417,300 b	85
90	53.7	275.5	246,300	412,500	58.0	279.4	234,600	403,200	64.1	283.7	217,100	389,500	90
95	50.1	271.2	229,900	386,500	54.6	275.8	218,900	377,800	61.0	280.8	202,400	364,900	95
100	46.3	266.4	215,100	363,400	51.1	271.7	204,800	355,200	57.7	277.5	189,200	343,000	100
105	42.2	260.8	201,700	342,600	47.4	267.0	192,000	334,900	54.3	273.8	177,300	323,300	105
110	37.7	254.3	189,500	323,900	43.4	261.6	180,400	316,500	50.8	269.7	166,500	305,600	110
115	32.7	246.5	178,400	306,800	39.0	255.4	169,700	299,900	47.0	264.9	156,600	289,500	115
120	26.7	236.8	168,000	291,300	34.2	248.0	159,900	284,700	43.0	259.5	147,500	274,900	120
125	18.9	223.4	158,200	277,000	28.5	239.0	150,800	270,800	38.6	253.1	139,100	261,400	125
130					21.4	226.9	142,200	257,900	33.7	245.6	131,300	249,000	130
135					9.1	205.0	133,500	245,800	27.9	236.4	124,000	237,600	135
140									20.6	223.9	116,900	226,900	140
145									6.2	198.2	109,500	216,600	145
150													150
155													155
160													160
165													165
170													170
175													175
180													180
185													185
190													190



# MLC650 VPC-MAX S-1

ASME B30.5

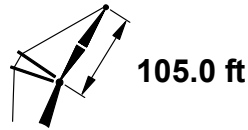
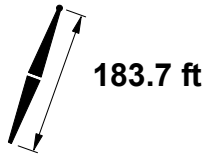

ft	75°				70°				65°				ft
	ft	ft	lb	lb	ft	ft	lb	lb	ft	ft	lb	lb	
60													60
65													65
70													70
75													75
80													80
85													85
90													90
95													95
100													100
105	64.5	280.2	153,000	304,400									105
110	61.4	277.4	143,400	287,600									110
115	58.1	274.2	134,700	272,400									115
120	54.8	270.6	126,700	258,600									120
125	51.2	266.5	119,400	245,900									125
130	47.5	261.8	112,500	234,300	58.3	269.3	93,700	219,800					130
135	43.5	256.4	106,200	223,500	54.9	265.7	88,200	209,600					135
140	39.2	250.2	100,200	213,500	51.4	261.6	83,100	200,200					140
145	34.3	242.9	94,600	204,300	47.7	256.9	78,300	191,500					145
150	28.7	233.9	89,300	195,600	43.7	251.6	73,700	183,400	54.8	259.1	58,100	171,500	150
155	21.7	222.0	84,100	187,400	39.4	245.5	69,500	175,800	51.2	254.9	54,500	164,300	155
160	9.8	200.9	78,700	179,500	34.6	238.2	65,400	168,700	47.5	250.3	51,100	157,600	160
165					29.0	229.3	61,400	161,900	43.5	244.9	47,800	151,400	165
170					22.1	217.6	57,600	155,500	39.2	238.7	44,700	145,400	170
175					10.8	197.6	53,400	149,200	34.3	231.4	41,700	139,800	175
180									28.7	222.4	38,700	134,500	180
185									21.7	210.5	35,800	129,400	185
190									9.8	189.3	32,500	124,200	190

# MLC650 VPC-MAX S-1

ASME B30.5

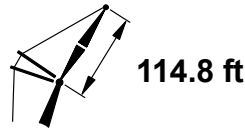
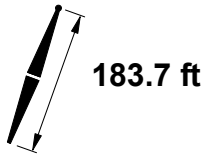

ft	85°				83°				80°				ft
	ft	lb	lb	lb	ft	lb	lb	lb	ft	lb	lb	lb	
60	74.1	302.7	403,600 b	670,300 b									60
65	71.4	301.0	366,000 b	607,700 b									65
70	68.8	298.9	334,200 b	555,200 b	72.2	300.7	318,400 b	542,700 b					70
75	66.0	296.6	306,900 b	510,700 b	69.5	298.7	292,300 b	499,200 b					75
80	63.2	294.0	283,200	472,400	66.8	296.5	269,600	461,700					80
85	60.3	291.1	262,400	439,100	64.0	294.0	249,700	429,100	69.2	297.0	230,700	414,200	85
90	57.3	287.8	244,100	409,900	61.1	291.1	232,100	400,500	66.5	294.7	214,300	386,600	90
95	54.2	284.1	227,700	384,100	58.2	287.9	216,500	375,300	63.7	292.1	199,600	362,100	95
100	51.0	279.9	213,000	361,100	55.1	284.4	202,400	352,700	60.8	289.2	186,500	340,300	100
105	47.6	275.3	199,700	340,400	51.9	280.4	189,700	332,500	57.9	286.0	174,700	320,800	105
110	44.0	270.0	187,700	321,800	48.5	275.8	178,200	314,300	54.8	282.4	164,000	303,200	110
115	40.1	264.0	176,700	304,900	45.0	270.8	167,700	297,800	51.6	278.3	154,200	287,200	115
120	35.8	257.1	166,500	289,400	41.2	265.0	158,000	282,700	48.2	273.8	145,200	272,600	120
125	31.0	248.8	157,100	275,300	37.0	258.3	149,100	268,900	44.6	268.7	136,900	259,200	125
130	25.3	238.5	148,300	262,300	32.4	250.5	140,800	256,100	40.8	262.8	129,200	247,000	130
135	17.7	224.2	139,900	250,200	27.0	240.8	133,000	244,400	36.6	256.0	122,100	235,600	135
140					20.1	228.0	125,600	233,400	31.9	248.0	115,400	225,100	140
145					7.8	204.0	117,900	223,000	26.4	238.2	109,000	215,300	145
150									19.3	224.9	102,900	206,100	150
155									4.2	195.1	96,100	197,200	155
160													160
165													165
170													170
175													175
180													180
185													185
190													190
195													195
200													200

# MLC650 VPC-MAX S-1

ASME B30.5

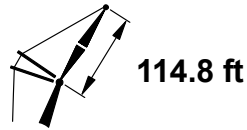
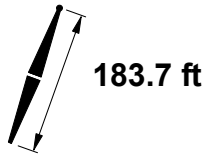

ft	75°				70°				65°				ft
	ft	°	ft	lb	ft	°	ft	lb	ft	°	ft	lb	
60													60
65													65
70													70
75													75
80													80
85													85
90													90
95													95
100													100
105													105
110	64.1	288.7	140,300	284,900									110
115	61.2	285.9	131,700	269,800									115
120	58.2	282.7	123,800	256,000									120
125	55.2	279.1	116,500	243,400									125
130	52.0	275.1	109,800	231,800									130
135	48.6	270.6	103,500	221,200	58.4	277.8	85,100	207,000					135
140	45.1	265.6	97,700	211,300	55.3	274.2	80,000	197,700					140
145	41.3	259.8	92,200	202,100	52.2	270.2	75,300	189,000					145
150	37.1	253.2	87,100	193,500	48.8	265.8	70,900	181,000					150
155	32.5	245.4	82,200	185,500	45.3	260.8	66,700	173,500					155
160	27.1	235.8	77,500	178,000	41.5	255.0	62,700	166,400	52.0	263.6	47,900	155,100	160
165	20.3	223.2	73,000	170,800	37.4	248.5	59,000	159,800	48.6	259.1	44,700	148,900	165
170	8.6	200.1	68,100	163,800	32.8	240.7	55,400	153,600	45.1	254.1	41,700	143,000	170
175					27.4	231.3	51,900	147,600	41.3	248.3	38,900	137,500	175
180					20.7	218.8	48,500	142,000	37.1	241.7	36,100	132,300	180
185					9.6	197.1	44,700	136,300	32.5	233.9	33,400	127,300	185
190									27.1	224.3	30,800	122,600	190
195									20.3	211.6	28,100	118,000	195
200									8.5	188.5	25,100	113,400	200

# MLC650 VPC-MAX S-1

ASME B30.5

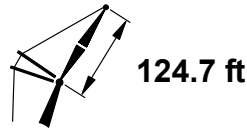
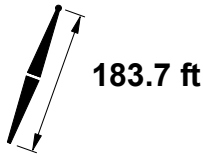

ft	85°				83°				80°				ft
	ft	lb	lb	lb	ft	lb	lb	lb	ft	lb	lb	lb	
65	73.0	311.4	429,000 b	606,100 b									65
70	70.5	309.6	392,400 b	553,900 b									70
75	68.0	307.5	361,000	509,600	71.2	309.3	346,200 b	498,000 b					75
80	65.5	305.1	333,700	471,500	68.7	307.3	319,900	460,700					80
85	62.9	302.5	309,900	438,400	66.2	305.0	297,000	428,300					85
90	60.2	299.5	288,800	409,300	63.6	302.5	276,700	399,900	68.5	305.5	258,500	385,900	90
95	57.5	296.3	270,000	383,600	61.0	299.6	258,600	374,700	66.0	303.2	241,500	361,500	95
100	54.7	292.6	253,200	360,700	58.3	296.4	242,400	352,300	63.4	300.6	226,300	339,800	100
105	51.7	288.6	238,000	340,100	55.4	292.9	227,800	332,200	60.7	297.7	212,500	320,400	105
110	48.6	284.1	224,200	321,600	52.5	289.0	214,500	314,000	58.0	294.5	200,000	302,800	110
115	45.4	279.1	211,600	304,700	49.5	284.6	202,400	297,600	55.2	291.0	188,700	286,900	115
120	41.9	273.5	200,100	289,400	46.3	279.8	191,400	282,600	52.2	287.0	178,300	272,400	120
125	38.2	267.1	189,500	275,400	42.9	274.3	181,200	268,800	49.2	282.6	168,700	259,100	125
130	34.1	259.7	179,700	262,500	39.2	268.2	171,800	256,200	46.0	277.7	159,800	246,900	130
135	29.4	250.9	170,500	250,500	35.3	261.1	163,000	244,600	42.6	272.2	151,600	235,700	135
140	23.9	240.1	161,900	239,500	30.8	252.8	154,800	233,800	38.9	265.9	144,000	225,300	140
145	16.6	224.9	153,600	229,100	25.6	242.6	147,100	223,700	34.9	258.8	136,800	215,600	145
150					18.9	229.0	139,700	214,300	30.3	250.3	130,100	206,600	150
155					6.6	202.6	132,100	205,300	25.0	239.9	123,700	198,100	155
160									18.2	225.8	117,500	190,100	160
165													165
170													170
175													175
180													180
185													185
190													190
195													195
200													200
205													205
210													210

# MLC650 VPC-MAX S-1

ASME B30.5

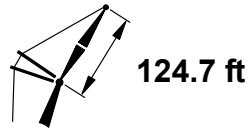
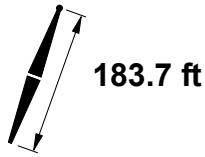

ft	75°				70°				65°				ft
	ft	°	ft	lb	ft	°	ft	lb	ft	°	ft	lb	
65													65
70													70
75													75
80													80
85													85
90													90
95													95
100													100
105													105
110													110
115	63.7	297.2	165,900	269,400									115
120	61.1	294.4	156,500	255,700									120
125	58.3	291.2	147,900	243,200									125
130	55.5	287.7	140,000	231,700									130
135	52.6	283.8	132,700	221,000									135
140	49.6	279.4	125,800	211,200	58.5	286.3	107,800	197,500					140
145	46.4	274.6	119,400	202,100	55.7	282.8	102,200	188,900					145
150	43.0	269.2	113,500	193,600	52.8	278.9	96,900	180,900					150
155	39.4	263.0	107,900	185,700	49.7	274.6	91,900	173,400					155
160	35.4	256.0	102,600	178,200	46.6	269.8	87,200	166,500					160
165	30.9	247.7	97,500	171,200	43.2	264.4	82,800	159,900	52.6	272.3	68,200	148,800	165
170	25.8	237.6	92,700	164,600	39.5	258.3	78,600	153,700	49.6	267.9	64,600	143,000	170
175	19.2	224.2	88,000	158,300	35.6	251.2	74,600	147,900	46.4	263.1	61,100	137,600	175
180	7.4	199.0	82,900	152,100	31.2	243.0	70,800	142,400	43.0	257.7	57,800	132,400	180
185					26.0	233.0	67,100	137,100	39.4	251.5	54,700	127,500	185
190					19.6	219.9	63,500	132,100	35.4	244.5	51,600	122,900	190
195					8.5	196.3	59,500	127,000	30.9	236.2	48,700	118,400	195
200									25.8	226.1	45,800	114,200	200
205									19.2	212.6	43,000	110,100	205
210									7.3	187.4	39,700	105,900	210

# MLC650 VPC-MAX S-1

ASME B30.5

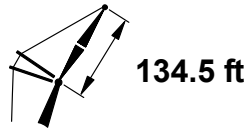
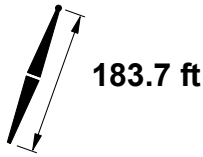

ft	85°				83°				80°				ft
	ft	lb	lb	lb	ft	lb	lb	lb	ft	lb	lb	lb	
65	74.3	321.8	426,500 b	589,700 b									65
70	72.0	320.1	389,900	550,700									70
75	69.7	318.2	358,600	506,600	72.6	319.8	343,500	494,900					75
80	67.4	316.0	331,300	468,700	70.4	317.9	317,300	457,800					80
85	65.1	313.6	307,500	435,700	68.1	315.9	294,400	425,500					85
90	62.6	311.0	286,500	406,800	65.7	313.5	274,100	397,200					90
95	60.2	308.0	267,700	381,200	63.3	310.9	256,100	372,200	67.8	314.1	238,700	358,800	95
100	57.6	304.8	250,900	358,300	60.9	308.1	239,900	349,800	65.5	311.7	223,500	337,200	100
105	55.0	301.2	235,800	337,900	58.4	304.9	225,400	329,800	63.1	309.1	209,800	317,800	105
110	52.3	297.3	222,100	319,400	55.8	301.4	212,200	311,700	60.6	306.2	197,400	300,300	110
115	49.5	292.9	209,600	302,600	53.1	297.6	200,100	295,300	58.1	303.0	186,100	284,500	115
120	46.5	288.1	198,100	287,400	50.3	293.4	189,100	280,400	55.5	299.5	175,700	270,100	120
125	43.4	282.8	187,600	273,400	47.4	288.7	179,000	266,800	52.8	295.6	166,200	256,900	125
130	40.1	276.8	177,800	260,600	44.3	283.5	169,700	254,200	50.0	291.4	157,400	244,700	130
135	36.5	270.0	168,800	248,700	41.0	277.7	161,000	242,600	47.1	286.6	149,300	233,500	135
140	32.6	262.2	160,400	237,700	37.5	271.2	152,900	231,900	44.0	281.4	141,700	223,200	140
145	28.1	253.0	152,500	227,500	33.7	263.7	145,400	221,900	40.7	275.5	134,700	213,600	145
150	22.8	241.5	145,000	218,000	29.4	254.9	138,300	212,600	37.2	268.9	128,000	204,600	150
155	15.6	225.4	137,700	209,000	24.4	244.2	131,500	203,900	33.3	261.3	121,800	196,200	155
160					17.9	229.9	125,100	195,700	29.0	252.4	115,900	188,400	160
165					5.2	200.5	118,200	187,800	23.8	241.4	110,300	181,000	165
170									17.1	226.6	104,800	174,000	170
175													175
180													180
185													185
190													190
195													195
200													200
205													205
210													210
215													215
220													220

# MLC650 VPC-MAX S-1

ASME B30.5

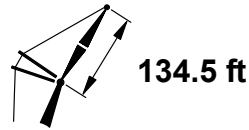
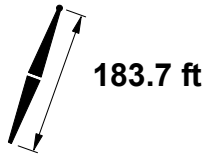

ft	75°				70°				65°				ft
	ft	°	ft	lb	ft	°	ft	lb	ft	°	ft	lb	
65													65
70													70
75													75
80													80
85													85
90													90
95													95
100													100
105													105
110													110
115													115
120	63.4	305.7	153,500	253,100									120
125	60.9	302.8	145,000	240,600									125
130	58.4	299.7	137,100	229,200									130
135	55.8	296.2	129,800	218,600									135
140	53.2	292.4	123,100	208,900									140
145	50.4	288.2	116,700	199,800	58.6	294.7	99,100	186,300					145
150	47.5	283.5	110,800	191,400	56.0	291.3	93,800	178,400					150
155	44.4	278.3	105,300	183,500	53.3	287.5	88,900	171,000					155
160	41.1	272.6	100,100	176,100	50.5	283.3	84,300	164,100					160
165	37.7	266.1	95,200	169,200	47.6	278.7	80,000	157,600					165
170	33.8	258.6	90,500	162,700	44.6	273.5	75,900	151,500	53.2	280.9	61,500	140,500	170
175	29.5	249.9	86,000	156,500	41.3	267.8	72,000	145,700	50.4	276.7	58,100	135,100	175
180	24.5	239.2	81,700	150,700	37.8	261.3	68,300	140,200	47.5	272.0	54,800	130,000	180
185	18.1	225.1	77,500	145,100	34.0	253.9	64,700	135,100	44.4	266.8	51,800	125,200	185
190	6.2	197.5	72,900	139,500	29.8	245.2	61,300	130,200	41.1	261.0	48,800	120,600	190
195					24.8	234.7	58,000	125,500	37.6	254.5	46,000	116,300	195
200					18.5	220.8	54,700	120,900	33.8	247.1	43,300	112,100	200
205					7.4	195.3	51,100	116,400	29.5	238.3	40,600	108,100	205
210									24.5	227.7	38,100	104,300	210
215									18.1	213.5	35,400	100,600	215
220									6.2	185.9	32,400	96,700	220

# MLC650 VPC-MAX S-1

ASME B30.5

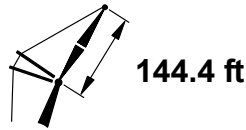
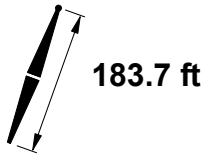

ft	85°				83°				80°				ft
	ft	lb	lb	lb	ft	lb	lb	lb	ft	lb	lb	lb	
70	73.3	330.5	388,100	544,800									70
75	71.2	328.7	356,800	504,100									75
80	69.1	326.8	329,600	466,400	71.8	328.5	315,400	455,400					80
85	66.9	324.6	305,800	433,500	69.7	326.5	292,500	423,300					85
90	64.7	322.1	284,800	404,700	67.5	324.4	272,300	395,100					90
95	62.4	319.4	266,100	379,200	65.3	322.0	254,300	370,100	69.4	324.8	236,700	356,600	95
100	60.1	316.5	249,300	356,400	63.1	319.4	238,200	347,900	67.3	322.6	221,600	335,100	100
105	57.8	313.3	234,200	336,000	60.8	316.5	223,600	327,900	65.1	320.2	207,900	315,800	105
110	55.3	309.7	220,500	317,600	58.4	313.4	210,500	309,900	62.8	317.6	195,500	298,400	110
115	52.8	305.9	208,000	300,900	56.0	310.0	198,500	293,600	60.5	314.7	184,200	282,700	115
120	50.2	301.6	196,600	285,700	53.5	306.2	187,500	278,700	58.2	311.5	173,900	268,300	120
125	47.5	297.0	186,100	271,800	51.0	302.1	177,400	265,100	55.8	308.0	164,400	255,100	125
130	44.7	291.9	176,500	259,000	48.3	297.6	168,100	252,600	53.3	304.2	155,700	243,100	130
135	41.7	286.2	167,500	247,200	45.5	292.6	159,500	241,100	50.7	300.1	147,600	231,900	135
140	38.5	279.9	159,200	236,300	42.5	287.1	151,500	230,400	48.0	295.5	140,100	221,600	140
145	35.0	272.8	151,400	226,200	39.4	280.9	144,100	220,500	45.2	290.5	133,100	212,100	145
150	31.2	264.6	144,100	216,800	36.0	274.0	137,100	211,300	42.2	284.9	126,600	203,200	150
155	26.9	254.9	137,200	207,900	32.3	266.2	130,500	202,700	39.1	278.7	120,400	194,800	155
160	21.7	242.8	130,600	199,600	28.2	257.0	124,300	194,600	35.7	271.7	114,600	187,100	160
165	14.7	225.9	124,200	191,800	23.3	245.7	118,400	187,000	31.9	263.8	109,100	179,700	165
170					17.0	230.6	112,600	179,800	27.7	254.4	103,900	172,900	170
175					3.4	197.0	106,400	172,700	22.7	242.9	98,900	166,300	175
180									16.2	227.2	94,000	160,100	180
185													185
190													190
195													195
200													200
205													205
210													210
215													215
220													220
225													225
230													230



# MLC650 VPC-MAX S-1

ASME B30.5

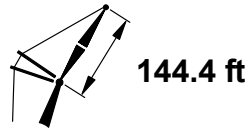
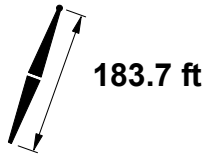

ft	75°				70°				65°				ft
	ft	°	ft	lb	ft	°	ft	lb	ft	°	ft	lb	
70													70
75													75
80													80
85													85
90													90
95													95
100													100
105													105
110													110
115													115
120													120
125	63.1	314.2	143,000	238,800									125
130	60.8	311.3	135,100	227,400									130
135	58.5	308.2	127,900	216,900									135
140	56.1	304.7	121,200	207,100									140
145	53.6	301.0	114,900	198,100									145
150	51.0	296.9	109,000	189,700	58.6	303.2	91,800	176,600					150
155	48.4	292.4	103,600	181,900	56.2	299.8	86,900	169,300					155
160	45.6	287.4	98,400	174,600	53.7	296.1	82,400	162,400					160
165	42.6	281.9	93,600	167,700	51.2	292.0	78,100	155,900					165
170	39.5	275.8	89,000	161,300	48.5	287.5	74,000	149,900					170
175	36.1	268.9	84,600	155,200	45.7	282.5	70,200	144,100	53.6	289.5	56,000	133,400	175
180	32.4	261.1	80,400	149,400	42.8	277.1	66,500	138,700	51.0	285.3	52,800	128,400	180
185	28.3	251.9	76,500	143,900	39.7	271.0	63,100	133,600	48.4	280.8	49,800	123,600	185
190	23.4	240.7	72,600	138,700	36.3	264.2	59,800	128,800	45.6	275.9	46,900	119,000	190
195	17.2	225.9	68,800	133,700	32.6	256.4	56,600	124,200	42.6	270.4	44,200	114,700	195
200	4.9	195.3	64,600	128,700	28.5	247.3	53,500	119,800	39.5	264.3	41,500	110,600	200
205					23.7	236.3	50,500	115,500	36.1	257.4	39,000	106,700	205
210					17.6	221.6	47,500	111,500	32.4	249.6	36,500	103,000	210
215					6.4	193.9	44,100	107,300	28.3	240.4	34,200	99,400	215
220									23.4	229.2	31,800	95,900	220
225									17.2	214.3	29,400	92,500	225
230									4.8	183.7	26,500	89,000	230

# MLC650 VPC-MAX S-1

ASME B30.5

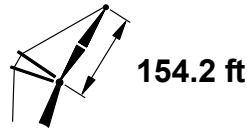
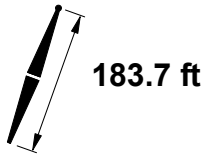

ft	85°				83°				80°				ft
	ft	lb	lb	lb	ft	lb	lb	lb	ft	lb	lb	lb	
70	74.4	340.8	385,600	499,000									70
75	72.4	339.2	354,300	499,000									75
80	70.5	337.4	327,200	463,600	73.0	338.9	312,700	452,500					80
85	68.5	335.3	303,400	430,900	71.0	337.1	289,900	420,500					85
90	66.4	333.1	282,400	402,200	69.0	335.1	269,700	392,400					90
95	64.4	330.6	263,700	376,700	67.0	332.9	251,700	367,500					95
100	62.2	327.9	247,000	354,100	64.9	330.5	235,700	345,400	68.8	333.3	218,700	332,500	100
105	60.1	325.0	231,900	333,800	62.8	327.9	221,200	325,500	66.8	331.1	205,100	313,300	105
110	57.9	321.8	218,300	315,400	60.7	325.0	208,000	307,600	64.7	328.7	192,800	295,900	110
115	55.6	318.3	205,800	298,800	58.5	321.9	196,100	291,300	62.6	326.0	181,600	280,200	115
120	53.3	314.5	194,400	283,700	56.2	318.5	185,200	276,500	60.5	323.1	171,300	265,900	120
125	50.9	310.3	184,000	269,800	53.9	314.8	175,100	263,000	58.3	320.0	161,800	252,800	125
130	48.4	305.8	174,400	257,100	51.6	310.7	165,900	250,500	56.0	316.5	153,100	240,800	130
135	45.8	300.9	165,400	245,300	49.1	306.3	157,300	239,000	53.7	312.8	145,100	229,700	135
140	43.0	295.5	157,200	234,400	46.5	301.5	149,300	228,400	51.3	308.7	137,600	219,500	140
145	40.1	289.5	149,400	224,400	43.8	296.3	141,900	218,600	48.8	304.3	130,700	209,900	145
150	37.0	282.9	142,200	215,000	41.0	290.5	135,000	209,400	46.2	299.5	124,200	201,100	150
155	33.7	275.4	135,400	206,200	37.9	284.0	128,500	200,800	43.5	294.1	118,100	192,800	155
160	30.0	266.8	129,000	198,000	34.7	276.8	122,400	192,800	40.7	288.3	112,400	185,100	160
165	25.8	256.7	122,900	190,200	31.1	268.5	116,600	185,300	37.6	281.8	107,000	177,800	165
170	20.8	244.1	117,100	183,000	27.0	258.9	111,100	178,200	34.3	274.4	101,900	171,000	170
175	13.9	226.3	111,400	176,000	22.3	247.1	105,800	171,500	30.7	266.1	97,000	164,600	175
180					16.1	231.3	100,700	165,100	26.6	256.3	92,400	158,500	180
185									21.8	244.2	87,900	152,700	185
190									15.4	227.8	83,500	147,100	190
195													195
200													200
205													205
210													210
215													215
220													220
225													225
230													230
235													235
240													240

# MLC650 VPC-MAX S-1

ASME B30.5

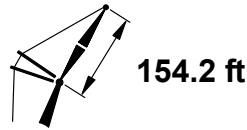
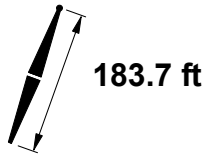

ft	75°				70°				65°				ft
	ft	°	ft	lb	ft	°	ft	lb	ft	°	ft	lb	
70													70
75													75
80													80
85													85
90													90
95													95
100													100
105													105
110													110
115													115
120													120
125	65.0	325.3	140,000	236,200									125
130	62.9	322.6	132,200	224,900									130
135	60.8	319.8	125,000	214,400									135
140	58.6	316.6	118,300	204,700									140
145	56.3	313.2	112,100	195,800									145
150	54.0	309.5	106,300	187,400									150
155	51.6	305.5	100,900	179,700	58.7	311.7	83,900	166,800					155
160	49.2	301.1	95,700	172,400	56.4	308.3	79,400	160,000					160
165	46.6	296.3	90,900	165,500	54.1	304.6	75,100	153,500					165
170	43.9	291.1	86,400	159,100	51.7	300.6	71,100	147,500					170
175	41.0	285.3	82,100	153,100	49.3	296.3	67,300	141,800					175
180	38.0	278.9	78,000	147,400	46.7	291.5	63,700	136,500	54.0	298.0	49,700	125,900	180
185	34.8	271.7	74,200	142,000	44.0	286.3	60,300	131,400	51.6	294.0	46,800	121,200	185
190	31.2	263.5	70,500	136,800	41.2	280.5	57,100	126,600	49.2	289.6	43,900	116,700	190
195	27.2	253.9	66,900	132,000	38.2	274.1	54,000	122,100	46.6	284.8	41,200	112,400	195
200	22.4	242.2	63,400	127,300	34.9	266.9	51,000	117,700	43.9	279.6	38,700	108,300	200
205	16.4	226.6	60,000	122,800	31.4	258.8	48,200	113,600	41.0	273.8	36,200	104,500	205
210	3.1	191.4	55,900	118,100	27.4	249.3	45,400	109,600	38.0	267.4	33,800	100,800	210
215					22.7	237.7	42,700	105,800	34.8	260.1	31,500	97,300	215
220					16.7	222.4	39,900	102,100	31.2	251.9	29,300	93,900	220
225					5.2	191.9	36,800	98,300	27.2	242.3	27,100	90,600	225
230									22.4	230.6	25,000	87,500	230
235									16.3	215.0	22,800	84,400	235
240									3.1	179.7	20,000	81,100	240

# MLC650 VPC-MAX S-1

ASME B30.5

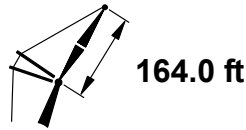
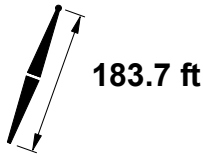

ft	85°				83°				80°				ft
	ft	lb	lb	lb	ft	lb	lb	lb	ft	lb	lb	lb	
75	73.5	349.6	353,700	457,300									75
80	71.7	347.9	326,600	456,900									80
85	69.8	346.0	302,800	429,500	72.2	347.6	289,200	419,100					85
90	67.9	343.9	281,900	400,900	70.3	345.7	269,000	391,100					90
95	66.0	341.6	263,200	375,600	68.5	343.7	251,100	366,400					95
100	64.1	339.1	246,500	353,100	66.5	341.5	235,000	344,300					100
105	62.1	336.4	231,400	332,800	64.6	339.0	220,600	324,500	68.3	341.9	204,400	312,200	105
110	60.0	333.4	217,800	314,500	62.6	336.4	207,500	306,600	66.4	339.6	192,000	294,900	110
115	58.0	330.2	205,400	298,000	60.6	333.5	195,500	290,400	64.4	337.2	180,800	279,300	115
120	55.9	326.8	194,000	282,900	58.6	330.4	184,600	275,700	62.4	334.5	170,600	265,000	120
125	53.7	323.1	183,600	269,000	56.5	327.0	174,600	262,200	60.4	331.6	161,200	252,000	125
130	51.4	319.0	174,000	256,400	54.3	323.3	165,400	249,800	58.4	328.5	152,500	240,000	130
135	49.1	314.6	165,100	244,600	52.1	319.4	156,800	238,300	56.2	325.1	144,500	228,900	135
140	46.7	309.8	156,900	233,800	49.8	315.1	148,900	227,800	54.1	321.4	137,100	218,700	140
145	44.2	304.7	149,200	223,800	47.4	310.4	141,500	217,900	51.8	317.4	130,100	209,200	145
150	41.5	299.0	142,000	214,400	44.9	305.4	134,700	208,800	49.5	313.1	123,700	200,400	150
155	38.7	292.7	135,300	205,700	42.3	299.8	128,200	200,300	47.1	308.4	117,600	192,200	155
160	35.7	285.7	128,900	197,500	39.5	293.7	122,100	192,300	44.6	303.2	111,900	184,500	160
165	32.5	277.9	123,000	189,900	36.6	287.0	116,400	184,800	42.0	297.7	106,600	177,300	165
170	28.9	268.9	117,300	182,700	33.4	279.4	111,000	177,800	39.2	291.5	101,600	170,500	170
175	24.8	258.4	111,900	175,800	29.9	270.8	105,900	171,100	36.3	284.7	96,800	164,100	175
180	19.9	245.2	106,700	169,400	26.0	260.7	101,000	164,900	33.1	277.0	92,200	158,000	180
185	13.2	226.5	101,600	163,200	21.4	248.4	96,300	158,900	29.6	268.3	87,900	152,300	185
190					15.4	231.9	91,700	153,200	25.6	258.0	83,800	146,900	190
195									20.9	245.5	79,700	141,700	195
200									14.6	228.3	75,700	136,700	200
205													205
210													210
215													215
220													220
225													225
230													230
235													235
240													240
245													245

# MLC650 VPC-MAX S-1

ASME B30.5

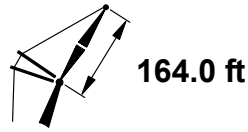
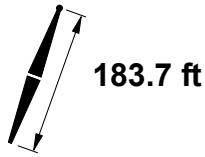

ft	75°				70°				65°				ft
	ft	°	ft	lb	ft	°	ft	lb	ft	°	ft	lb	
75													75
80													80
85													85
90													90
95													95
100													100
105													105
110													110
115													115
120													120
125													125
130	64.7	333.8	131,300	223,900									130
135	62.7	331.1	124,100	213,500									135
140	60.7	328.2	117,500	203,900									140
145	58.6	325.1	111,300	194,900									145
150	56.5	321.8	105,500	186,600									150
155	54.4	318.1	100,100	178,900									155
160	52.1	314.2	95,100	171,600	58.7	320.2	78,500	159,100					160
165	49.8	309.9	90,300	164,800	56.6	316.8	74,300	152,700					165
170	47.4	305.2	85,800	158,500	54.5	313.2	70,300	146,700					170
175	45.0	300.2	81,600	152,400	52.2	309.3	66,500	141,100					175
180	42.4	294.6	77,500	146,800	49.9	305.0	63,000	135,700					180
185	39.6	288.6	73,700	141,400	47.6	300.4	59,600	130,700	54.4	306.6	45,800	120,300	185
190	36.7	281.8	70,100	136,300	45.1	295.3	56,400	126,000	52.1	302.6	43,100	115,900	190
195	33.5	274.3	66,600	131,500	42.5	289.8	53,400	121,400	49.8	298.4	40,400	111,600	195
200	30.1	265.7	63,200	126,900	39.8	283.8	50,500	117,100	47.4	293.7	37,900	107,600	200
205	26.1	255.7	60,000	122,500	36.8	277.1	47,700	113,000	45.0	288.7	35,400	103,800	205
210	21.5	243.5	56,900	118,300	33.7	269.6	45,000	109,100	42.4	283.1	33,100	100,100	210
215	15.6	227.2	53,700	114,200	30.2	261.1	42,400	105,400	39.6	277.0	30,900	96,700	215
220					26.4	251.1	39,800	101,800	36.7	270.3	28,700	93,300	220
225					21.8	239.1	37,400	98,300	33.5	262.8	26,600	90,100	225
230					15.9	223.0	34,900	95,000	30.1	254.2	24,600	87,100	230
235					3.9	189.1	31,900	91,400	26.1	244.2	22,600	84,100	235
240									21.5	232.0	20,600	81,200	240
245									15.6	215.6	18,400	78,400	245

# MLC650 VPC-MAX S-1

ASME B30.5

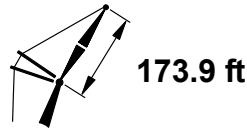
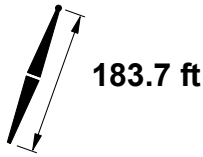

ft	85°				83°				80°				ft
	ft	lb	lb	lb	ft	lb	lb	lb	ft	lb	lb	lb	
75	74.5	359.9	351,300	420,200									75
80	72.8	358.3	324,200	420,200									80
85	71.0	356.5	300,400	420,000									85
90	69.3	354.6	279,500	398,400	71.5	356.2	266,400	388,500					90
95	67.5	352.4	260,800	373,200	69.7	354.3	248,500	363,800					95
100	65.6	350.1	244,100	350,700	68.0	352.3	232,500	341,800					100
105	63.8	347.6	229,100	330,500	66.2	350.0	218,000	322,100	69.6	352.5	201,600	309,600	105
110	61.9	344.9	215,500	312,300	64.3	347.5	205,000	304,300	67.8	350.4	189,300	292,400	110
115	60.0	341.9	203,100	295,800	62.5	344.9	193,100	288,200	66.0	348.2	178,100	276,800	115
120	58.1	338.7	191,800	280,800	60.5	342.0	182,200	273,500	64.1	345.7	167,900	262,600	120
125	56.1	335.3	181,400	267,000	58.6	338.9	172,200	260,000	62.3	343.0	158,500	249,600	125
130	54.0	331.6	171,800	254,300	56.6	335.5	163,000	247,700	60.4	340.1	149,900	237,700	130
135	51.9	327.7	162,900	242,700	54.6	331.9	154,500	236,300	58.4	337.0	141,900	226,700	135
140	49.7	323.4	154,700	231,900	52.5	328.0	146,600	225,700	56.4	333.6	134,500	216,500	140
145	47.5	318.7	147,000	221,900	50.4	323.8	139,300	215,900	54.4	329.9	127,600	207,100	145
150	45.2	313.7	139,900	212,600	48.1	319.3	132,400	206,800	52.3	326.0	121,200	198,300	150
155	42.7	308.2	133,200	203,900	45.8	314.4	126,000	198,300	50.1	321.8	115,200	190,100	155
160	40.2	302.3	126,900	195,700	43.4	309.0	120,000	190,400	47.9	317.2	109,500	182,400	160
165	37.4	295.7	121,000	188,100	40.9	303.2	114,300	182,900	45.6	312.3	104,200	175,300	165
170	34.5	288.5	115,400	180,900	38.2	296.8	109,000	175,900	43.2	306.9	99,200	168,500	170
175	31.4	280.3	110,200	174,200	35.4	289.8	103,900	169,300	40.6	301.0	94,500	162,100	175
180	27.9	271.0	105,100	167,800	32.3	281.9	99,100	163,100	38.0	294.6	90,000	156,100	180
185	23.9	260.0	100,300	161,700	28.9	272.9	94,500	157,200	35.1	287.5	85,800	150,500	185
190	19.1	246.3	95,600	156,000	25.1	262.4	90,100	151,600	32.0	279.5	81,700	145,100	190
195	12.5	226.7	91,000	150,400	20.6	249.7	85,900	146,300	28.6	270.4	77,800	140,000	195
200					14.6	232.4	81,700	141,200	24.7	259.7	74,100	135,100	200
205									20.1	246.7	70,400	130,400	205
210									13.9	228.7	66,800	125,900	210
215													215
220													220
225													225
230													230
235													235
240													240
245													245
250													250
255													255

# MLC650 VPC-MAX S-1

ASME B30.5

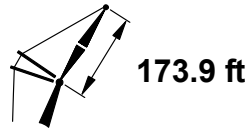
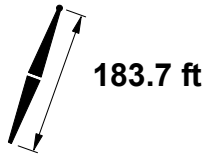

ft	75°				70°				65°				ft
	ft	lb	lb	lb	ft	lb	lb	lb	ft	lb	lb	lb	
75													75
80													80
85													85
90													90
95													95
100													100
105													105
110													110
115													115
120													120
125													125
130													130
135	64.4	342.3	121,200	211,000									135
140	62.5	339.6	114,600	201,500									140
145	60.6	336.7	108,400	192,600									145
150	58.7	333.6	102,700	184,300									150
155	56.7	330.3	97,400	176,600									155
160	54.7	326.7	92,300	169,400									160
165	52.6	322.8	87,600	162,600	58.8	328.7	71,200	150,300					165
170	50.4	318.6	83,100	156,300	56.8	325.3	67,300	144,300					170
175	48.2	314.1	78,900	150,300	54.8	321.7	63,600	138,700					175
180	45.9	309.2	75,000	144,700	52.7	317.9	60,100	133,400					180
185	43.5	303.8	71,200	139,300	50.5	313.7	56,800	128,400					185
190	41.0	298.0	67,600	134,300	48.3	309.2	53,600	123,700	54.7	315.1	40,000	113,500	190
195	38.3	291.7	64,200	129,500	46.0	304.3	50,600	119,200	52.6	311.3	37,400	109,300	195
200	35.5	284.7	60,900	125,000	43.6	299.0	47,700	115,000	50.4	307.1	34,900	105,300	200
205	32.4	276.8	57,700	120,600	41.1	293.2	45,000	110,900	48.2	302.5	32,500	101,500	205
210	29.0	267.9	54,700	116,500	38.4	286.9	42,400	107,000	45.9	297.6	30,200	97,900	210
215	25.2	257.4	51,800	112,500	35.6	279.9	39,800	103,400	43.5	292.3	28,000	94,400	215
220	20.7	244.8	48,900	108,700	32.6	272.1	37,400	99,800	41.0	286.5	25,900	91,100	220
225	14.9	227.7	46,000	105,000	29.2	263.2	35,000	96,400	38.3	280.2	23,900	88,000	225
230					25.4	252.9	32,700	93,200	35.5	273.1	21,900	84,900	230
235					21.0	240.4	30,500	90,000	32.4	265.3	20,000	82,000	235
240					15.2	223.6	28,200	86,900	29.0	256.3		79,200	240
245									25.2	245.9		76,500	245
250									20.7	233.2		73,900	250
255									14.8	216.2		71,300	255

# MLC650 VPC-MAX S-1

ASME B30.5

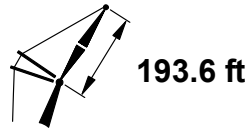
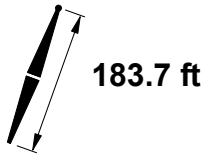

ft	85°				83°				80°				ft
	ft	lb	lb	lb	ft	lb	lb	lb	ft	lb	lb	lb	
80	74.6	378.9	321,000	354,800									80
85	73.0	377.4	297,300	354,800									85
90	71.5	375.6	276,400	354,600									90
95	69.9	373.8	257,800	353,900	71.9	375.3	245,200	350,400					95
100	68.3	371.7	241,100	347,300	70.3	373.5	229,200	338,200					100
105	66.7	369.5	226,100	327,200	68.7	371.5	214,800	318,600					105
110	65.0	367.1	212,500	309,100	67.1	369.3	201,700	301,000					110
115	63.4	364.6	200,200	292,700	65.5	367.0	189,900	284,900	68.6	369.7	174,500	273,300	115
120	61.7	361.8	188,900	277,800	63.8	364.5	179,000	270,300	67.0	367.5	164,400	259,200	120
125	60.0	358.9	178,500	264,100	62.1	361.8	169,100	256,900	65.3	365.2	155,100	246,300	125
130	58.2	355.7	169,000	251,500	60.4	358.9	159,900	244,700	63.7	362.7	146,500	234,500	130
135	56.4	352.3	160,100	239,900	58.7	355.8	151,500	233,300	62.0	359.9	138,500	223,600	135
140	54.6	348.7	151,900	229,200	56.9	352.5	143,600	222,900	60.3	357.0	131,200	213,500	140
145	52.7	344.9	144,300	219,200	55.1	349.0	136,300	213,100	58.5	353.9	124,300	204,100	145
150	50.8	340.8	137,200	210,000	53.3	345.2	129,500	204,100	56.8	350.6	118,000	195,400	150
155	48.8	336.3	130,600	201,300	51.4	341.1	123,100	195,700	54.9	347.0	112,000	187,200	155
160	46.8	331.6	124,400	193,200	49.4	336.8	117,200	187,800	53.1	343.2	106,400	179,600	160
165	44.7	326.5	118,500	185,700	47.4	332.2	111,600	180,400	51.2	339.1	101,200	172,500	165
170	42.5	321.0	113,000	178,600	45.3	327.2	106,300	173,400	49.2	334.8	96,200	165,800	170
175	40.2	315.0	107,800	171,900	43.1	321.8	101,300	166,900	47.2	330.1	91,500	159,500	175
180	37.8	308.6	102,900	165,500	40.8	315.9	96,600	160,700	45.1	325.1	87,100	153,600	180
185	35.2	301.5	98,200	159,600	38.4	309.6	92,100	154,900	42.9	319.6	82,900	147,900	185
190	32.4	293.6	93,800	153,900	35.9	302.7	87,800	149,400	40.6	313.8	79,000	142,600	190
195	29.4	284.8	89,500	148,500	33.2	295.1	83,800	144,100	38.2	307.4	75,200	137,600	195
200	26.1	274.8	85,400	143,400	30.3	286.6	79,900	139,200	35.7	300.4	71,600	132,800	200
205	22.3	262.9	81,500	138,500	27.1	276.9	76,200	134,400	33.0	292.7	68,100	128,200	205
210	17.7	248.2	77,700	133,900	23.4	265.7	72,600	129,900	30.0	284.1	64,800	123,900	210
215	11.2	226.7	73,800	129,300	19.1	251.9	69,100	125,500	26.8	274.3	61,600	119,700	215
220					13.4	233.1	65,600	121,300	23.1	262.9	58,500	115,700	220
225									18.6	248.8	55,500	111,900	225
230									12.6	229.2	52,400	108,100	230
235													235
240													240
245													245
250													250
255													255
260													260
265													265
270													270
275													275



# MLC650 VPC-MAX S-1

ASME B30.5

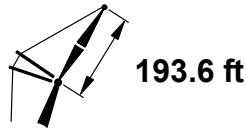
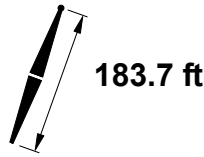

ft	75°				70°				65°				ft
	ft	lb	ft	lb	ft	lb	ft	lb	ft	lb	ft	lb	
80													80
85													85
90													90
95													95
100													100
105													105
110													110
115													115
120													120
125													125
130													130
135													135
140													140
145	63.9	359.2	104,600	189,200									145
150	62.2	356.6	99,000	181,100									150
155	60.5	353.7	93,600	173,400									155
160	58.8	350.6	88,700	166,300									160
165	57.0	347.3	84,000	159,600									165
170	55.2	343.7	79,600	153,300									170
175	53.3	340.0	75,500	147,400	58.8	345.6	59,700	135,500					175
180	51.4	335.9	71,500	141,800	57.1	342.3	56,200	130,300					180
185	49.5	331.6	67,800	136,500	55.3	338.8	53,000	125,300					185
190	47.4	327.0	64,300	131,500	53.4	335.1	49,900	120,600					190
195	45.3	322.0	60,900	126,800	51.5	331.0	46,900	116,200					195
200	43.2	316.6	57,700	122,300	49.6	326.7	44,100	112,000					200
205	40.9	310.8	54,700	118,000	47.5	322.1	41,400	108,000	53.3	328.5	98,300		205
210	38.5	304.5	51,800	113,900	45.5	317.1	38,900	104,200	51.4	324.4	94,700		210
215	36.0	297.6	49,000	110,000	43.3	311.8	36,400	100,600	49.5	320.1	91,300		215
220	33.3	290.0	46,300	106,300	41.0	306.0	34,100	97,100	47.4	315.4	88,100		220
225	30.4	281.5	43,700	102,800	38.6	299.7	31,800	93,800	45.3	310.5	85,000		225
230	27.2	271.9	41,200	99,400	36.1	292.8	29,700	90,600	43.2	305.1	82,000		230
235	23.6	260.7	38,700	96,100	33.4	285.3	27,600	87,500	40.9	299.3	79,200		235
240	19.3	247.0	36,300	92,900	30.5	276.9	25,500	84,600	38.5	293.0	76,500		240
245	13.6	228.5	33,900	89,800	27.4	267.3	23,500	81,800	36.0	286.1	73,800		245
250					23.8	256.2	21,600	79,000	33.3	278.5	71,300		250
255					19.5	242.7		76,400	30.4	270.0	68,900		255
260					13.9	224.5		73,700	27.2	260.4	66,500		260
265									23.6	249.2	64,200		265
270									19.2	235.5	62,000		270
275									13.6	216.9	59,700		275

# MLC650 VPC-MAX S-1

ASME B30.5



440,900 lb

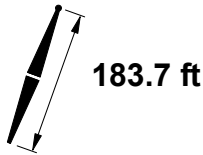

183.7 ft

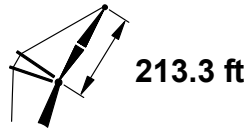

213.3 ft

ft	85°				83°				80°				ft
	ft	lb	lb	lb	ft	lb	lb	lb	ft	lb	lb	lb	
85	74.6	398.0	294,200	301,900									85
90	73.2	396.4	273,300	301,800									90
95	71.8	394.7	254,700	301,500									95
100	70.4	392.9	238,100	301,000	72.2	394.4	225,900	297,700					100
105	68.9	390.9	223,100	300,200	70.8	392.7	211,500	297,700					105
110	67.5	388.8	209,500	299,200	69.4	390.7	198,500	297,600					110
115	66.0	386.6	197,200	289,600	67.9	388.6	186,700	281,700					115
120	64.5	384.1	185,900	274,700	66.4	386.4	175,800	267,200	69.2	388.9	160,800	255,900	120
125	63.0	381.5	175,600	261,100	64.9	384.0	165,900	253,900	67.8	386.8	151,600	243,100	125
130	61.5	378.8	166,000	248,600	63.4	381.5	156,800	241,700	66.3	384.6	143,000	231,300	130
135	59.9	375.8	157,200	237,100	61.9	378.8	148,400	230,400	64.8	382.2	135,100	220,400	135
140	58.3	372.7	149,100	226,400	60.3	375.9	140,500	220,000	63.3	379.6	127,800	210,400	140
145	56.7	369.4	141,500	216,500	58.8	372.8	133,300	210,300	61.8	376.9	121,000	201,100	145
150	55.1	365.8	134,400	207,300	57.2	369.5	126,500	201,300	60.2	374.0	114,600	192,400	150
155	53.4	362.1	127,800	198,700	55.5	366.0	120,100	192,900	58.6	370.9	108,700	184,300	155
160	51.7	358.1	121,600	190,700	53.9	362.3	114,200	185,100	57.0	367.6	103,200	176,800	160
165	49.9	353.8	115,800	183,200	52.2	358.4	108,600	177,700	55.4	364.1	97,900	169,700	165
170	48.1	349.3	110,300	176,100	50.4	354.2	103,400	170,800	53.7	360.4	93,000	163,000	170
175	46.2	344.4	105,200	169,400	48.6	349.8	98,400	164,300	52.0	356.4	88,400	156,800	175
180	44.3	339.3	100,300	163,100	46.7	345.0	93,800	158,200	50.2	352.2	84,000	150,900	180
185	42.3	333.7	95,700	157,200	44.8	339.9	89,300	152,400	48.4	347.7	79,900	145,300	185
190	40.2	327.8	91,300	151,600	42.9	334.5	85,100	147,000	46.6	342.9	76,000	140,000	190
195	38.0	321.4	87,100	146,300	40.8	328.7	81,200	141,800	44.6	337.8	72,200	135,000	195
200	35.7	314.4	83,100	141,200	38.6	322.4	77,300	136,800	42.7	332.4	68,700	130,300	200
205	33.3	306.8	79,300	136,400	36.4	315.6	73,700	132,100	40.6	326.5	65,300	125,800	205
210	30.6	298.4	75,700	131,800	34.0	308.2	70,300	127,700	38.4	320.2	62,100	121,500	210
215	27.8	289.0	72,200	127,500	31.4	300.0	66,900	123,400	36.1	313.3	59,000	117,400	215
220	24.6	278.3	68,800	123,300	28.6	290.9	63,700	119,300	33.7	305.8	56,000	113,400	220
225	20.9	265.6	65,600	119,200	25.5	280.6	60,600	115,400	31.1	297.6	53,100	109,700	225
230	16.5	249.8	62,400	115,400	22.0	268.6	57,600	111,700	28.3	288.4	50,400	106,100	230
235	10.1	226.4	59,100	111,600	17.8	253.8	54,700	108,000	25.2	277.9	47,700	102,600	235
240					12.2	233.5	51,700	104,500	21.7	265.7	45,100	99,300	240
245									17.4	250.6	42,500	96,100	245
250									11.5	229.4	39,900	92,900	250
255													255
260													260
265													265
270													270
275													275
280													280
290													290

# MLC650 VPC-MAX S-1

ASME B30.5

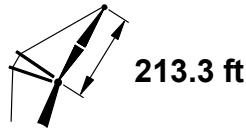
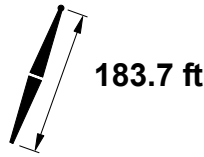

ft	75°				70°				65°			
	ft	lb	ft	lb	ft	lb	ft	lb	ft	lb	ft	
85												85
90												90
95												95
100												100
105												105
110												110
115												115
120												120
125												125
130												130
135												135
140												140
145												145
150	65.0	378.8	95,200	177,800								150
155	63.5	376.2	89,900	170,200								155
160	61.9	373.5	85,000	163,100								160
165	60.4	370.6	80,300	156,500								165
170	58.8	367.5	76,000	150,200								170
175	57.2	364.3	71,900	144,400								175
180	55.6	360.8	68,000	138,800								180
185	53.9	357.1	64,300	133,600	58.9	362.6	49,100	122,200				185
190	52.2	353.2	60,800	128,600	57.3	359.3	46,000	117,500				190
195	50.5	349.0	57,500	123,900	55.7	355.9	43,100	113,100				195
200	48.7	344.6	54,400	119,500	54.0	352.2	40,400	109,000				200
205	46.8	339.8	51,400	115,300	52.3	348.3	37,700	105,000				205
210	44.9	334.8	48,500	111,200	50.5	344.1	35,200	101,200				210
215	42.9	329.3	45,800	107,400	48.7	339.7	32,800	97,600	53.9	345.6	88,200	215
220	40.9	323.5	43,200	103,700	46.9	335.0	30,600	94,200	52.2	341.7	85,000	220
225	38.7	317.3	40,700	100,200	45.0	329.9	28,400	90,900	50.5	337.5	82,000	225
230	36.4	310.5	38,200	96,900	43.0	324.5	26,200	87,800	48.7	333.0	79,000	230
235	34.0	303.1	35,900	93,600	41.0	318.7	24,200	84,800	46.8	328.3	76,200	235
240	31.5	294.9	33,700	90,500	38.8	312.5	22,300	81,900	44.9	323.2	73,500	240
245	28.7	285.9	31,500	87,600	36.6	305.7	20,400	79,200	42.9	317.8	71,000	245
250	25.6	275.6	29,400	84,700	34.2	298.4		76,500	40.9	312.0	68,500	250
255	22.1	263.6	27,300	81,900	31.6	290.3		73,900	38.7	305.7	66,100	255
260	18.0	249.0	25,200	79,200	28.8	281.2		71,400	36.4	299.0	63,800	260
265	12.4	229.0	23,100	76,600	25.8	271.0		69,000	34.0	291.6	61,600	265
270					22.3	259.2		66,700	31.5	283.4	59,400	270
275					18.2	244.7		64,400	28.7	274.3	57,300	275
280					12.8	225.1		62,200	25.6	264.1	55,300	280
290									18.0	237.5	51,400	290

# MLC650 VPC-MAX S-1

ASME B30.5



440,900 lb



360°

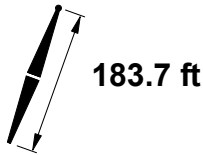

183.7 ft

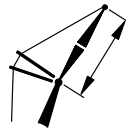

232.9 ft

ft	85°				83°				80°				ft
	ft	lb	lb	lb	ft	lb	lb	lb	ft	lb	lb	lb	
90	74.7	417.0	267,800	273,200									90
95	73.4	415.5	249,300	273,000									95
100	72.1	413.8	232,700	272,600									100
105	70.8	412.1	217,800	272,000	72.5	413.5	205,700	268,700					105
110	69.5	410.2	204,200	271,200	71.2	411.8	192,800	268,700					110
115	68.2	408.1	191,900	270,400	69.9	409.9	181,000	268,700					115
120	66.8	405.9	180,700	269,400	68.5	407.9	170,300	262,300					120
125	65.5	403.6	170,400	256,600	67.2	405.8	160,400	249,100	69.7	408.1	145,500	238,000	125
130	64.1	401.1	160,900	244,200	65.8	403.5	151,300	237,000	68.4	406.1	137,000	226,300	130
135	62.7	398.5	152,100	232,700	64.5	401.0	142,900	225,800	67.1	404.0	129,200	215,500	135
140	61.3	395.7	144,000	222,100	63.1	398.5	135,100	215,500	65.7	401.7	121,900	205,600	140
145	59.9	392.8	136,500	212,300	61.7	395.7	127,900	205,900	64.3	399.2	115,200	196,300	145
150	58.4	389.7	129,400	203,100	60.3	392.8	121,200	196,900	63.0	396.6	108,900	187,700	150
155	57.0	386.4	122,800	194,600	58.8	389.8	114,900	188,600	61.6	393.9	103,000	179,700	155
160	55.5	382.9	116,700	186,600	57.4	386.5	109,000	180,800	60.1	390.9	97,500	172,200	160
165	53.9	379.2	110,900	179,100	55.9	383.1	103,500	173,500	58.7	387.9	92,400	165,200	165
170	52.4	375.3	105,500	172,100	54.4	379.4	98,300	166,700	57.2	384.6	87,500	158,600	170
175	50.8	371.2	100,300	165,500	52.8	375.6	93,400	160,200	55.7	381.1	82,900	152,400	175
180	49.1	366.8	95,500	159,200	51.2	371.5	88,700	154,100	54.2	377.5	78,600	146,500	180
185	47.5	362.2	90,900	153,300	49.6	367.2	84,300	148,400	52.7	373.6	74,500	141,000	185
190	45.7	357.3	86,600	147,700	47.9	362.7	80,200	142,900	51.1	369.5	70,600	135,800	190
195	44.0	352.0	82,500	142,500	46.2	357.9	76,200	137,800	49.4	365.2	67,000	130,800	195
200	42.1	346.5	78,500	137,400	44.5	352.7	72,500	132,900	47.8	360.6	63,500	126,100	200
205	40.2	340.5	74,800	132,700	42.6	347.3	68,900	128,200	46.1	355.8	60,100	121,600	205
210	38.2	334.2	71,200	128,100	40.8	341.4	65,500	123,800	44.3	350.6	56,900	117,400	210
215	36.1	327.3	67,800	123,800	38.8	335.2	62,200	119,600	42.5	345.1	53,900	113,300	215
220	33.9	319.9	64,500	119,700	36.7	328.5	59,100	115,600	40.6	339.3	51,000	109,400	220
225	31.6	311.8	61,400	115,700	34.6	321.2	56,100	111,700	38.6	333.0	48,200	105,700	225
230	29.1	302.8	58,400	111,900	32.3	313.3	53,200	108,000	36.5	326.2	45,500	102,200	230
235	26.3	292.8	55,500	108,300	29.8	304.6	50,500	104,500	34.3	318.9	43,000	98,800	235
240	23.3	281.5	52,600	104,800	27.1	295.0	47,800	101,100	32.0	310.9	40,500	95,500	240
245	19.7	268.0	49,900	101,400	24.2	284.0	45,200	97,800	29.5	302.1	38,100	92,400	245
250	15.4	251.1	47,200	98,200	20.8	271.2	42,700	94,700	26.8	292.4	35,800	89,400	250
255	9.0	225.7	44,300	95,000	16.7	255.5	40,100	91,600	23.9	281.3	33,500	86,500	255
260					11.2	233.6	37,600	88,600	20.4	268.3	31,300	83,700	260
265									16.3	252.2	29,100	80,900	265
270									10.5	229.2	26,800	78,200	270
275													275
280													280
290													290
300													300
310													310

# MLC650 VPC-MAX S-1

ASME B30.5

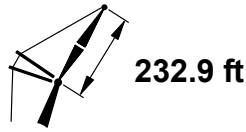
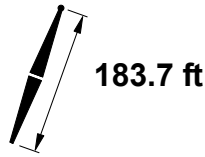

ft	75°				70°				65°			
	ft	lb	ft	lb	ft	lb	ft	lb	ft	lb	ft	
90												90
95												95
100												100
105												105
110												110
115												115
120												120
125												125
130												130
135												135
140												140
145												145
150												150
155												155
160	64.5	395.8	78,700	158,100								160
165	63.1	393.2	74,100	151,500								165
170	61.7	390.5	69,800	145,300								170
175	60.3	387.6	65,800	139,500								175
180	58.9	384.5	61,900	134,000								180
185	57.4	381.3	58,300	128,900								185
190	55.9	377.8	54,900	124,000								190
195	54.4	374.2	51,700	119,300	58.9	379.6	36,700	108,100				195
200	52.9	370.4	48,600	114,900	57.5	376.3	34,000	104,000				200
205	51.3	366.3	45,600	110,700	56.0	372.9	31,400	100,100				205
210	49.6	362.0	42,800	106,800	54.5	369.3	29,000	96,400				210
215	48.0	357.5	40,100	103,000	52.9	365.5	26,700	92,900				215
220	46.3	352.7	37,600	99,300	51.3	361.4	24,400	89,500				220
225	44.5	347.5	35,100	95,900	49.7	357.2	22,300	86,300	54.4	362.7	76,900	225
230	42.7	342.1	32,800	92,600	48.1	352.6	20,200	83,200	52.9	358.9	74,100	230
235	40.8	336.3	30,500	89,400	46.4	347.8		80,200	51.3	354.8	71,300	235
240	38.8	330.0	28,300	86,400	44.6	342.7		77,400	49.6	350.5	68,700	240
245	36.8	323.3	26,200	83,400	42.8	337.3		74,700	48.0	346.0	66,100	245
250	34.6	316.1	24,200	80,600	40.9	331.5		72,000	46.3	341.2	63,700	250
255	32.3	308.2	22,300	77,900	38.9	325.3		69,500	44.5	336.0	61,400	255
260	29.9	299.6	20,400	75,300	36.9	318.6		67,100	42.7	330.6	59,100	260
265	27.2	289.9		72,800	34.7	311.4		64,800	40.8	324.8	57,000	265
270	24.3	279.0		70,400	32.4	303.5		62,500	38.8	318.5	54,900	270
275	20.9	266.3		68,000	30.0	294.9		60,300	36.8	311.8	52,800	275
280	16.9	250.7		65,700	27.3	285.3		58,200	34.6	304.6	50,900	280
290					21.1	261.9		54,200	29.9	288.0	47,200	290
300					11.8	225.4		50,200	24.2	267.5	43,600	300
310									16.9	239.2	40,300	310

# MLC650 VPC-MAX S-1

ASME B30.5

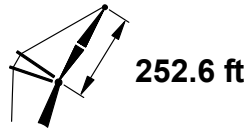
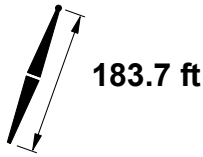

ft	85°				83°				80°				ft
	ft	lb	lb	lb	ft	lb	lb	lb	ft	lb	lb	lb	
95	74.7	436.1	234,600	234,600									95
100	73.6	434.6	229,400	234,200									100
105	72.4	432.9	214,500	233,700									105
110	71.2	431.2	201,000	233,100	72.7	432.6	189,300	230,200					110
115	70.0	429.3	188,700	232,300	71.5	430.9	177,500	230,200					115
120	68.7	427.3	177,500	231,500	70.3	429.1	166,800	230,100					120
125	67.5	425.2	167,200	230,500	69.1	427.1	157,000	229,800					125
130	66.3	423.0	157,700	229,500	67.9	425.0	147,900	229,400					130
135	65.0	420.6	149,000	228,500	66.6	422.8	139,600	222,700	69.0	425.3	125,500	212,200	135
140	63.7	418.1	140,900	219,200	65.4	420.5	131,800	212,400	67.7	423.2	118,300	202,300	140
145	62.5	415.5	133,300	209,400	64.1	418.0	124,600	202,900	66.5	421.0	111,600	193,200	145
150	61.2	412.7	126,300	200,300	62.8	415.4	117,900	194,000	65.2	418.7	105,300	184,600	150
155	59.8	409.7	119,800	191,800	61.5	412.7	111,600	185,700	64.0	416.2	99,500	176,600	155
160	58.5	406.6	113,600	183,800	60.2	409.8	105,800	178,000	62.7	413.6	94,000	169,200	160
165	57.2	403.4	107,900	176,400	58.9	406.7	100,200	170,700	61.4	410.8	88,900	162,200	165
170	55.8	399.9	102,400	169,400	57.5	403.5	95,100	163,900	60.1	407.9	84,100	155,700	170
175	54.4	396.3	97,300	162,800	56.2	400.1	90,200	157,500	58.8	404.8	79,500	149,500	175
180	53.0	392.5	92,500	156,600	54.8	396.5	85,600	151,400	57.4	401.6	75,200	143,700	180
185	51.5	388.5	88,000	150,700	53.4	392.8	81,200	145,700	56.0	398.2	71,100	138,200	185
190	50.0	384.2	83,600	145,200	51.9	388.8	77,100	140,300	54.6	394.6	67,300	133,000	190
195	48.5	379.8	79,500	139,900	50.4	384.6	73,200	135,200	53.2	390.8	63,600	128,000	195
200	46.9	375.0	75,700	135,000	48.9	380.2	69,400	130,300	51.8	386.8	60,200	123,400	200
205	45.3	370.1	71,900	130,200	47.4	375.6	65,900	125,700	50.3	382.6	56,900	118,900	205
210	43.7	364.8	68,400	125,700	45.8	370.7	62,500	121,300	48.8	378.2	53,700	114,700	210
215	42.0	359.2	65,000	121,400	44.2	365.5	59,300	117,100	47.2	373.5	50,700	110,700	215
220	40.2	353.3	61,800	117,300	42.5	360.0	56,200	113,100	45.6	368.6	47,800	106,800	220
225	38.4	346.9	58,700	113,400	40.7	354.2	53,300	109,300	44.0	363.4	45,100	103,200	225
230	36.5	340.2	55,800	109,600	38.9	348.0	50,400	105,600	42.3	357.9	42,500	99,600	230
235	34.5	332.9	52,900	106,000	37.0	341.3	47,700	102,100	40.6	352.0	39,900	96,300	235
240	32.4	325.0	50,200	102,600	35.1	334.2	45,100	98,800	38.7	345.7	37,500	93,100	240
245	30.1	316.4	47,500	99,300	33.0	326.5	42,600	95,600	36.8	339.1	35,200	90,000	245
250	27.7	307.0	45,000	96,100	30.8	318.1	40,100	92,500	34.9	331.9	32,900	87,000	250
255	25.0	296.5	42,500	93,000	28.4	308.9	37,800	89,500	32.8	324.1	30,700	84,100	255
260	22.1	284.4	40,100	90,100	25.8	298.7	35,500	86,600	30.5	315.7	28,600	81,400	260
265	18.7	270.2	37,700	87,200	23.0	287.1	33,300	83,800	28.1	306.4	26,600	78,700	265
270	14.4	252.2	35,300	84,400	19.7	273.6	31,100	81,100	25.5	296.1	24,600	76,100	270
275	8.1	224.6	32,900	79,900	15.7	257.0	28,900	78,500	22.7	284.3	22,600	73,700	275
280					10.3	233.4	26,700	75,900	19.3	270.6	20,700	71,200	280
290									9.6	228.8		66,500	290
300													300
310													310
320													320
330													330

# MLC650 VPC-MAX S-1

ASME B30.5

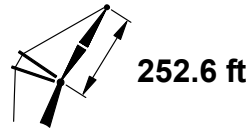
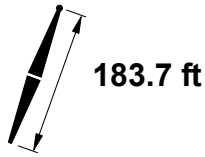

ft	75°				70°			65°			ft
	°	ft	lb	lb	°	ft	lb	°	ft	lb	
95											95
100											100
105											105
110											110
115											115
120											120
125											125
130											130
135											135
140											140
145											145
150											150
155											155
160											160
165											165
170	64.1	412.8	66,000	142,100							170
175	62.9	410.2	61,900	136,400							175
180	61.6	407.4	58,200	130,900							180
185	60.3	404.5	54,600	125,800							185
190	58.9	401.5	51,200	120,900							190
195	57.6	398.2	48,000	116,300							195
200	56.2	394.9	44,900	112,000							200
205	54.8	391.3	42,000	107,800	59.0	396.5	97,000				205
210	53.4	387.5	39,300	103,900	57.6	393.3	93,300				210
215	51.9	383.6	36,600	100,100	56.3	389.9	89,800				215
220	50.5	379.4	34,100	96,500	54.9	386.4	86,400				220
225	49.0	375.0	31,700	93,100	53.5	382.6	83,200				225
230	47.4	370.4	29,300	89,800	52.0	378.7	80,200				230
235	45.8	365.5	27,100	86,700	50.5	374.5	77,300	54.8	379.8	68,200	235
240	44.2	360.3	25,000	83,700	49.0	370.2	74,500	53.4	376.0	65,600	240
245	42.5	354.8	22,900	80,800	47.5	365.5	71,800	51.9	372.1	63,100	245
250	40.8	349.0	21,000	78,000	45.9	360.7	69,200	50.5	367.9	60,700	250
255	39.0	342.8		75,300	44.3	355.5	66,700	49.0	363.5	58,400	255
260	37.1	336.2		72,800	42.6	350.0	64,300	47.4	358.9	56,100	260
265	35.1	329.1		70,300	40.9	344.2	62,000	45.8	354.0	54,000	265
270	33.0	321.4		67,900	39.1	338.0	59,800	44.2	348.8	52,000	270
275	30.8	313.0		65,600	37.2	331.4	57,700	42.5	343.3	50,000	275
280	28.5	303.9		63,400	35.2	324.3	55,600	40.8	337.5	48,000	280
290	23.0	282.2		59,100	30.9	308.4	51,700	37.1	324.7	44,400	290
300	15.9	252.2		55,000	26.0	289.1	47,900	33.0	309.9	41,000	300
310					20.0	264.4	44,400	28.5	292.4	37,800	310
320					10.8	225.4	41,000	23.0	270.7	34,700	320
330								15.9	240.7	31,700	330

# MLC650 VPC-MAX S-1

ASME B30.5

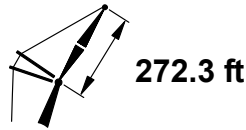
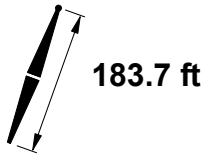

ft	85°				83°				80°				ft
	ft	lb	lb	lb	ft	lb	lb	lb	ft	lb	lb	lb	
100	74.8	455.1	203,000	203,000									100
105	73.7	453.6	202,500	202,500									105
110	72.6	452.0	198,800	202,000									110
115	71.5	450.3	186,600	201,300	72.9	451.7	175,200	199,300					115
120	70.4	448.5	175,400	200,600	71.8	450.0	164,500	199,100					120
125	69.2	446.5	165,100	199,800	70.7	448.2	154,700	198,900					125
130	68.1	444.5	155,700	198,900	69.5	446.3	145,700	198,600					130
135	66.9	442.3	147,000	198,000	68.4	444.3	137,400	198,100					135
140	65.8	440.0	138,900	197,000	67.3	442.2	129,600	197,600	69.4	444.5	115,900	191,700	140
145	64.6	437.6	131,400	196,000	66.1	439.9	122,500	197,100	68.3	442.5	109,200	190,900	145
150	63.4	435.1	124,400	195,100	64.9	437.5	115,800	192,000	67.2	440.4	103,000	182,400	150
155	62.2	432.4	117,900	189,900	63.8	435.0	109,500	183,700	66.0	438.1	97,200	174,500	155
160	61.0	429.6	111,700	182,000	62.6	432.4	103,700	176,000	64.8	435.7	91,700	167,100	160
165	59.8	426.7	106,000	174,600	61.4	429.6	98,200	168,800	63.7	433.2	86,600	160,200	165
170	58.6	423.6	100,600	167,600	60.2	426.7	93,100	162,000	62.5	430.5	81,800	153,600	170
175	57.3	420.3	95,500	161,100	58.9	423.7	88,200	155,600	61.3	427.8	77,300	147,500	175
180	56.1	416.9	90,700	154,900	57.7	420.5	83,600	149,600	60.0	424.8	73,000	141,700	180
185	54.8	413.4	86,200	149,100	56.4	417.1	79,300	143,900	58.8	421.8	69,000	136,300	185
190	53.4	409.6	81,900	143,600	55.1	413.6	75,200	138,600	57.6	418.6	65,200	131,100	190
195	52.1	405.7	77,800	138,300	53.8	409.9	71,300	133,500	56.3	415.2	61,600	126,200	195
200	50.7	401.6	73,900	133,400	52.5	406.0	67,600	128,600	55.0	411.7	58,100	121,600	200
205	49.4	397.2	70,300	128,700	51.1	402.0	64,100	124,000	53.7	407.9	54,800	117,200	205
210	47.9	392.7	66,800	124,200	49.7	397.7	60,700	119,700	52.4	404.0	51,700	113,000	210
215	46.5	387.9	63,400	119,900	48.3	393.2	57,500	115,500	51.0	400.0	48,700	109,000	215
220	45.0	382.9	60,200	115,800	46.9	388.5	54,500	111,500	49.6	395.7	45,900	105,100	220
225	43.5	377.6	57,200	111,900	45.4	383.5	51,500	107,800	48.2	391.2	43,200	101,500	225
230	41.9	372.0	54,200	108,200	43.9	378.3	48,700	104,100	46.7	386.4	40,600	98,000	230
235	40.2	366.0	51,400	104,700	42.3	372.8	46,100	100,700	45.3	381.4	38,100	94,700	235
240	38.5	359.7	48,700	101,200	40.7	366.9	43,500	97,300	43.7	376.2	35,700	91,500	240
245	36.8	353.0	46,100	98,000	39.0	360.7	41,000	94,100	42.2	370.6	33,400	88,400	245
250	35.0	345.9	43,600	94,800	37.3	354.1	38,600	91,100	40.5	364.7	31,200	85,500	250
255	33.0	338.2	41,200	91,800	35.5	347.1	36,300	88,100	38.9	358.5	29,000	82,700	255
260	31.0	329.9	38,900	88,900	33.6	339.6	34,100	85,300	37.1	351.9	27,000	79,900	260
265	28.8	320.9	36,600	86,100	31.6	331.5	32,000	82,600	35.3	344.8	25,000	77,300	265
270	26.5	310.9	34,400	83,400	29.4	322.7	29,900	79,900	33.4	337.2	23,100	74,800	270
275	23.9	299.8	32,300	80,700	27.1	313.0	27,900	77,400	31.4	329.1	21,200	72,300	275
280	21.0	287.1	30,200	78,200	24.6	302.2	25,900	74,900	29.2	320.2		70,000	280
290	13.6	253.1	26,100	73,300	18.7	275.8	22,100	70,200	24.4	299.5		65,500	290
300					9.4	232.9		65,700	18.4	272.7		61,200	300
310									8.7	228.0		57,100	310
320													320
330													330
340													340
350													350



# MLC650 VPC-MAX S-1

ASME B30.5

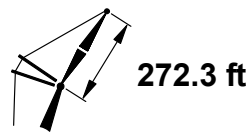
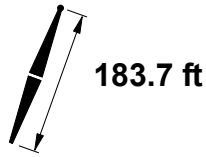

ft	75°				70°			65°			ft
	°	ft	lb	lb	ft	lb	ft	lb	ft		
100										100	
105										105	
110										110	
115										115	
120										120	
125										125	
130										130	
135										135	
140										140	
145										145	
150										150	
155										155	
160										160	
165										165	
170										170	
175	65.0	432.3	59,400	134,200						175	
180	63.8	429.8	55,600	128,800						180	
185	62.6	427.1	52,100	123,700						185	
190	61.4	424.4	48,700	118,900						190	
195	60.2	421.5	45,600	114,300						195	
200	59.0	418.4	42,500	110,000						200	
205	57.7	415.2	39,700	105,800						205	
210	56.4	411.9	36,900	101,900						210	
215	55.2	408.4	34,300	98,200	59.0	413.5	87,700			215	
220	53.9	404.7	31,800	94,600	57.8	410.3	84,400			220	
225	52.5	400.8	29,400	91,200	56.5	406.9	81,200			225	
230	51.2	396.7	27,100	88,000	55.2	403.4	78,200			230	
235	49.8	392.5	25,000	84,900	53.9	399.8	75,300			235	
240	48.4	388.0	22,900	81,900	52.6	395.9	72,500			240	
245	46.9	383.3	20,800	79,000	51.2	391.8	69,800			245	
250	45.4	378.3		76,300	49.9	387.6	67,300	53.9	393.2	58,600	250
255	43.9	373.1		73,600	48.4	383.1	64,800	52.5	389.3	56,300	255
260	42.4	367.6		71,100	47.0	378.4	62,500	51.2	385.2	54,100	260
265	40.7	361.8		68,700	45.5	373.5	60,200	49.8	381.0	52,000	265
270	39.1	355.6		66,300	44.0	368.3	58,000	48.4	376.5	50,000	270
275	37.3	349.0		64,000	42.4	362.8	55,900	46.9	371.8	48,000	275
280	35.5	342.0		61,800	40.8	357.0	53,900	45.4	366.8	46,100	280
290	31.6	326.4		57,700	37.4	344.2	50,000	42.4	356.1	42,600	290
300	27.2	308.0		53,800	33.7	329.8	46,400	39.1	344.1	39,200	300
310	22.0	285.1		50,100	29.6	312.9	43,000	35.5	330.5	36,100	310
320	15.0	253.5		46,500	24.9	292.7	39,700	31.6	314.9	33,100	320
330					19.0	266.6	36,700	27.2	296.4	30,300	330
340					10.0	225.1	33,600	22.0	273.6	27,600	340
350								15.0	241.9	24,900	350

# MLC650 VPC-MAX S-1

ASME B30.5



440,900 lb



360°

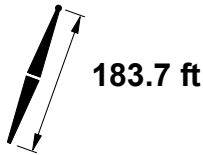

183.7 ft

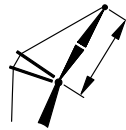

292.0 ft

ft	85°				83°				80°				ft
	ft	lb	lb	lb	ft	lb	lb	lb	ft	lb	lb	lb	
105	74.8	474.2	189,700	189,700									105
110	73.8	472.7	189,200	189,200									110
115	72.8	471.1	178,800	188,500									115
120	71.7	469.4	167,600	187,800									120
125	70.7	467.6	157,400	187,000	72.0	469.1	146,500	185,700					125
130	69.6	465.7	148,000	186,200	71.0	467.3	137,500	185,300					130
135	68.6	463.7	139,300	185,300	69.9	465.5	129,300	184,900					135
140	67.5	461.6	131,300	184,300	68.9	463.5	121,600	184,400					140
145	66.5	459.4	123,800	183,300	67.8	461.4	114,500	183,800	69.8	463.7	100,600	178,400	145
150	65.4	457.1	116,800	182,300	66.7	459.3	107,800	183,200	68.8	461.7	94,400	175,700	150
155	64.3	454.6	110,300	181,200	65.7	457.0	101,600	177,500	67.7	459.6	88,700	167,900	155
160	63.2	452.1	104,200	176,100	64.6	454.6	95,800	169,900	66.6	457.5	83,300	160,500	160
165	62.1	449.4	98,500	168,700	63.5	452.0	90,400	162,700	65.6	455.1	78,200	153,700	165
170	60.9	446.6	93,200	161,800	62.4	449.4	85,300	155,900	64.5	452.7	73,500	147,200	170
175	59.8	443.6	88,100	155,300	61.2	446.6	80,400	149,600	63.4	450.2	69,000	141,100	175
180	58.6	440.6	83,300	149,200	60.1	443.7	75,900	143,600	62.3	447.5	64,800	135,400	180
185	57.5	437.3	78,800	143,400	59.0	440.6	71,600	138,000	61.1	444.7	60,800	130,000	185
190	56.3	434.0	74,500	137,900	57.8	437.5	67,500	132,600	60.0	441.8	57,000	124,900	190
195	55.1	430.4	70,500	132,700	56.6	434.1	63,700	127,600	58.9	438.7	53,500	120,000	195
200	53.9	426.7	66,600	127,700	55.4	430.6	60,000	122,800	57.7	435.5	50,100	115,400	200
205	52.6	422.9	63,000	123,000	54.2	427.0	56,500	118,200	56.5	432.2	46,800	111,000	205
210	51.4	418.9	59,500	118,600	53.0	423.2	53,200	113,900	55.3	428.7	43,700	106,900	210
215	50.1	414.6	56,200	114,300	51.7	419.2	50,000	109,700	54.1	425.0	40,800	102,900	215
220	48.8	410.2	53,000	110,300	50.4	415.1	47,000	105,800	52.9	421.2	38,000	99,100	220
225	47.4	405.6	50,000	106,400	49.1	410.7	44,100	102,000	51.6	417.2	35,300	95,500	225
230	46.1	400.8	47,100	102,700	47.8	406.1	41,300	98,400	50.3	413.0	32,800	92,000	230
235	44.7	395.7	44,300	99,200	46.5	401.3	38,700	95,000	49.0	408.7	30,300	88,700	235
240	43.2	390.3	41,600	95,800	45.1	396.3	36,100	91,700	47.7	404.1	27,900	85,600	240
245	41.8	384.7	39,000	92,500	43.6	391.1	33,700	88,500	46.3	399.3	25,700	82,500	245
250	40.2	378.8	36,600	89,400	42.2	385.5	31,300	85,500	44.9	394.2	23,500	79,600	250
255	38.7	372.5	34,200	86,400	40.7	379.7	29,100	82,500	43.5	388.9	21,400	76,800	255
260	37.0	365.9	31,900	83,500	39.1	373.5	26,900	79,700	42.0	383.4		74,100	260
265	35.3	358.8	29,700	80,700	37.5	367.0	24,800	77,000	40.5	377.5		71,500	265
270	33.6	351.3	27,600	78,000	35.8	360.0	22,700	74,400	39.0	371.3		69,000	270
275	31.7	343.2	25,500	75,500	34.1	352.6	20,800	71,900	37.3	364.7		66,600	275
280	29.7	334.5	23,500	73,000	32.2	344.7		69,500	35.7	357.7		64,300	280
290	25.4	314.6		68,200	28.2	326.9		64,900	32.1	342.3		59,900	290
300	20.1	289.7		63,700	23.6	305.5		60,500	28.0	324.4		55,700	300
310	12.8	253.8		59,500	17.8	277.8		56,400	23.4	302.8		51,800	310
320					8.6	232.1		52,400	17.5	274.6		48,100	320
330									7.9	226.8		44,500	330
340													340
350													350
360													360

# MLC650 VPC-MAX S-1

ASME B30.5

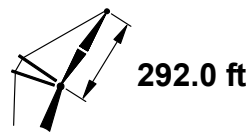
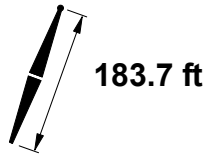

ft	75°				70°			65°			ft
	°	ft	lb	lb	°	ft	lb	°	ft	lb	
105											105
110											110
115											115
120											120
125											125
130											130
135											135
140											140
145											145
150											150
155											155
160											160
165											165
170											170
175											175
180											180
185	64.6	449.3	43,100	116,800							185
190	63.5	446.8	39,800	112,100							190
195	62.4	444.1	36,700	107,500							195
200	61.3	441.3	33,700	103,300							200
205	60.1	438.4	30,900	99,200							205
210	59.0	435.4	28,200	95,300							210
215	57.8	432.2	25,700	91,600							215
220	56.7	428.9	23,200	88,100							220
225	55.5	425.4	20,900	84,700	59.1	430.4	74,300				225
230	54.3	421.8		81,500	57.9	427.3	71,300				230
235	53.0	418.0		78,500	56.7	424.0	68,400				235
240	51.8	414.0		75,500	55.5	420.5	65,700				240
245	50.5	409.8		72,700	54.3	416.9	63,100				245
250	49.2	405.5		70,000	53.1	413.1	60,600				250
255	47.9	400.9		67,400	51.8	409.1	58,200				255
260	46.5	396.2		64,900	50.6	404.9	55,900	54.2	410.3	47,100	260
265	45.1	391.1		62,500	49.3	400.6	53,600	53.0	406.5	45,100	265
270	43.7	385.9		60,100	47.9	396.1	51,500	51.8	402.5	43,100	270
275	42.2	380.3		57,900	46.6	391.3	49,400	50.5	398.3	41,200	275
280	40.7	374.5		55,700	45.2	386.3	47,400	49.2	394.0	39,300	280
290	37.6	361.8		51,600	42.3	375.5	43,600	46.5	384.6	35,800	290
300	34.1	347.5		47,800	39.2	363.6	40,000	43.7	374.4	32,500	300
310	30.4	331.1		44,200	36.0	350.2	36,700	40.7	363.0	29,500	310
320	26.1	311.8		40,800	32.4	334.9	33,600	37.5	350.3	26,600	320
330	21.0	287.8		37,500	28.4	317.3	30,600	34.1	336.0	23,800	330
340	14.2	254.5		34,400	23.8	296.1	27,800	30.4	319.6	21,200	340
350					18.1	268.7	25,100				350
360					9.2	224.5	22,400				360

# MLC650 VPC-MAX S-1

ASME B30.5

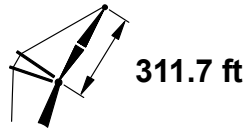
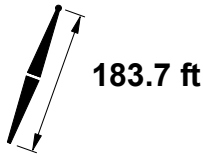

ft	85°				83°				80°				ft
	ft	lb	lb	lb	ft	lb	lb	lb	ft	lb	lb	lb	
110	74.9	493.2	164,600	164,600									110
115	73.9	491.7	164,000	164,000									115
120	72.9	490.2	163,300	163,300									120
125	72.0	488.5	155,600	162,400									125
130	71.0	486.7	146,200	161,700	72.2	488.2	135,500	160,400					130
135	70.0	484.9	137,500	160,900	71.3	486.5	127,300	160,200					135
140	69.0	482.9	129,500	160,000	70.3	484.6	119,600	159,600					140
145	68.0	480.9	122,000	159,100	69.3	482.7	112,500	158,900					145
150	67.0	478.7	115,100	158,100	68.3	480.7	105,900	158,300					150
155	66.0	476.5	108,600	157,100	67.3	478.6	99,700	157,700	69.2	480.9	86,500	153,600	155
160	65.0	474.1	102,500	156,200	66.3	476.3	93,900	157,000	68.2	478.9	81,200	153,500	160
165	64.0	471.6	96,800	155,200	65.3	474.0	88,500	156,200	67.2	476.8	76,100	151,800	165
170	62.9	469.1	91,500	154,100	64.3	471.6	83,400	154,200	66.2	474.5	71,400	145,300	170
175	61.9	466.4	86,400	153,700	63.2	469.0	78,600	147,900	65.2	472.2	67,000	139,300	175
180	60.8	463.5	81,600	147,600	62.2	466.3	74,100	142,000	64.2	469.7	62,800	133,600	180
185	59.8	460.6	77,200	141,800	61.1	463.5	69,800	136,300	63.1	467.2	58,800	128,200	185
190	58.7	457.5	72,900	136,300	60.1	460.6	65,700	131,000	62.1	464.5	55,000	123,100	190
195	57.6	454.3	68,900	131,200	59.0	457.6	61,900	126,000	61.0	461.7	51,500	118,300	195
200	56.5	451.0	65,000	126,300	57.9	454.4	58,200	121,200	60.0	458.8	48,100	113,700	200
205	55.4	447.5	61,400	121,600	56.8	451.1	54,800	116,700	58.9	455.7	44,900	109,300	205
210	54.2	443.8	57,900	117,100	55.7	447.7	51,400	112,300	57.8	452.5	41,800	105,200	210
215	53.1	440.1	54,600	112,900	54.6	444.1	48,300	108,200	56.7	449.2	38,900	101,300	215
220	51.9	436.1	51,400	108,900	53.4	440.3	45,300	104,300	55.6	445.7	36,100	97,500	220
225	50.7	432.0	48,400	105,000	52.2	436.4	42,400	100,600	54.4	442.1	33,500	93,900	225
230	49.5	427.7	45,500	101,300	51.1	432.4	39,600	97,000	53.3	438.4	30,900	90,500	230
235	48.3	423.2	42,700	97,800	49.9	428.1	37,000	93,500	52.1	434.5	28,500	87,200	235
240	47.0	418.5	40,100	94,400	48.6	423.7	34,500	90,300	50.9	430.4	26,100	84,000	240
245	45.7	413.6	37,500	91,200	47.4	419.0	32,100	87,100	49.7	426.1	23,900	81,000	245
250	44.4	408.5	35,100	88,100	46.1	414.2	29,700	84,100	48.5	421.6	21,700	78,100	250
255	43.1	403.1	32,700	85,100	44.8	409.1	27,500	81,200	47.2	417.0		75,300	255
260	41.7	397.5	30,500	82,200	43.4	403.8	25,300	78,400	46.0	412.1		72,700	260
265	40.3	391.5	28,300	79,500	42.1	398.3	23,200	75,700	44.7	407.0		70,100	265
270	38.8	385.3	26,200	76,800	40.7	392.4	21,200	73,100	43.3	401.7		67,600	270
275	37.3	378.7	24,100	74,200	39.2	386.3		70,600	41.9	396.1		65,200	275
280	35.7	371.7	22,200	71,800	37.7	379.8		68,200	40.5	390.2		62,900	280
290	32.3	356.4		67,000	34.5	365.6		63,600	37.5	377.5		58,500	290
300	28.6	338.9		62,600	31.0	349.6		59,300	34.3	363.3		54,400	300
310	24.4	318.1		58,500	27.2	331.0		55,300	30.9	347.2		50,600	310
320	19.2	292.0		54,600	22.6	308.6		51,500	27.0	328.4		47,000	320
330	12.0	254.2		50,800	17.0	279.6		47,900	22.4	305.8		43,500	330
340					7.9	230.9		44,400	16.7	276.3		40,300	340
350									7.1	225.2		37,000	350
360													360

# MLC650 VPC-MAX S-1

ASME B30.5

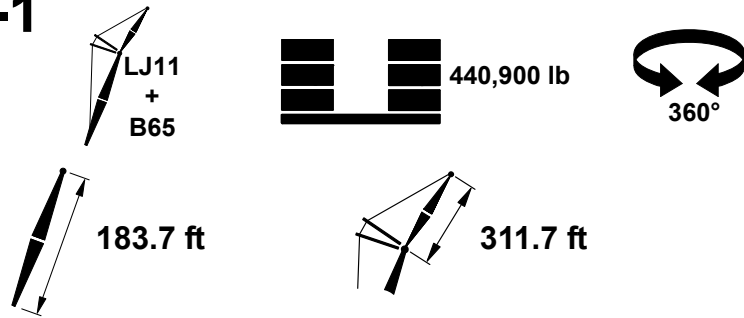

ft	75°			70°			65°			ft
	ft	lb	ft	ft	lb	ft	ft	lb	ft	
110										110
115										115
120										120
125										125
130										130
135										135
140										140
145										145
150										150
155										155
160										160
165										165
170										170
175										175
180										180
185										185
190										190
195	64.3	466.3	105,600							195
200	63.3	463.7	101,400							200
205	62.2	461.1	97,300							205
210	61.2	458.3	93,500							210
215	60.1	455.4	89,800							215
220	59.0	452.3	86,300							220
225	57.9	449.2	83,000							225
230	56.8	445.9	79,800							230
235	55.7	442.4	76,700	59.1	447.4	66,500				235
240	54.6	438.9	73,800	58.0	444.2	63,800				240
245	53.4	435.1	71,000	56.9	440.9	61,200				245
250	52.3	431.2	68,300	55.8	437.5	58,700				250
255	51.1	427.1	65,700	54.7	433.9	56,400				255
260	49.9	422.9	63,200	53.5	430.2	54,100				260
265	48.7	418.5	60,900	52.3	426.3	51,800				265
270	47.4	413.8	58,500	51.2	422.3	49,700	54.6	427.3	41,200	270
275	46.1	409.0	56,300	50.0	418.0	47,700	53.4	423.6	39,300	275
280	44.8	403.9	54,200	48.7	413.6	45,700	52.3	419.7	37,400	280
290	42.1	393.1	50,100	46.2	404.2	41,900	49.9	411.4	34,000	290
300	39.2	381.1	46,300	43.6	393.8	38,400	47.4	402.3	30,700	300
310	36.2	367.8	42,800	40.8	382.4	35,100	44.8	392.4	27,700	310
320	32.9	352.8	39,400	37.8	369.9	32,000	42.1	381.6	24,900	320
330	29.2	335.6	36,200	34.6	355.8	29,100	39.2	369.6	22,200	330
340	25.1	315.4	33,200	31.2	339.9	26,300				340
350	20.1	290.4	30,400	27.3	321.4	23,700				350
360	13.4	255.4	27,600	22.8	299.2	21,200				360

# MLC650 VPC-MAX S-1

ASME B30.5

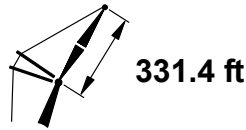
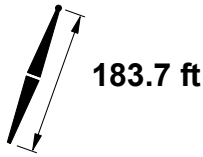

ft	85°				83°				80°				ft
	ft	lb	lb	lb	ft	lb	lb	lb	ft	lb	lb	lb	
115	74.9	512.3	141,500	141,500									115
120	74.0	510.8	140,900	140,900									120
125	73.1	509.2	140,200	140,200									125
130	72.2	507.6	139,400	139,400									130
135	71.2	505.9	134,200	138,600	72.4	507.3	123,800	137,700					135
140	70.3	504.0	126,200	137,800	71.5	505.6	116,200	137,100					140
145	69.4	502.1	118,700	137,000	70.6	503.8	109,100	136,600					145
150	68.5	500.1	111,800	136,100	69.7	501.9	102,500	135,900					150
155	67.5	498.0	105,300	135,200	68.7	499.9	96,300	135,300					155
160	66.6	495.8	99,200	134,300	67.8	497.8	90,500	134,600	69.6	500.1	77,500	131,100	160
165	65.6	493.5	93,600	133,400	66.9	495.7	85,100	133,900	68.6	498.1	72,500	130,900	165
170	64.7	491.1	88,200	132,400	65.9	493.4	80,000	133,200	67.7	496.0	67,800	130,600	170
175	63.7	488.6	83,200	131,500	64.9	491.0	75,200	132,500	66.8	493.9	63,400	130,200	175
180	62.7	486.0	78,400	130,600	64.0	488.6	70,700	131,700	65.8	491.6	59,200	129,900	180
185	61.8	483.3	73,900	129,600	63.0	486.0	66,400	131,000	64.9	489.2	55,200	125,300	185
190	60.8	480.5	69,700	128,700	62.0	483.3	62,400	128,300	63.9	486.7	51,500	120,200	190
195	59.8	477.5	65,700	127,800	61.0	480.5	58,500	123,200	62.9	484.1	48,000	115,400	195
200	58.7	474.5	61,800	123,600	60.0	477.6	54,900	118,500	61.9	481.4	44,600	110,800	200
205	57.7	471.3	58,200	119,000	59.0	474.6	51,400	114,000	60.9	478.6	41,400	106,500	205
210	56.7	468.0	54,700	114,500	58.0	471.4	48,100	109,700	59.9	475.7	38,300	102,400	210
215	55.6	464.5	51,400	110,300	57.0	468.1	45,000	105,600	58.9	472.7	35,400	98,500	215
220	54.6	460.9	48,300	106,300	55.9	464.7	42,000	101,600	57.9	469.5	32,700	94,700	220
225	53.5	457.2	45,300	102,500	54.9	461.2	39,100	97,900	56.9	466.2	30,000	91,100	225
230	52.4	453.3	42,400	98,800	53.8	457.5	36,400	94,300	55.8	462.8	27,500	87,700	230
235	51.3	449.3	39,600	95,300	52.7	453.6	33,800	90,900	54.8	459.2	25,100	84,500	235
240	50.2	445.1	37,000	91,900	51.6	449.6	31,300	87,700	53.7	455.5	22,700	81,300	240
245	49.0	440.7	34,400	88,700	50.5	445.5	28,800	84,500	52.6	451.6	20,500	78,300	245
250	47.8	436.1	32,000	85,600	49.3	441.1	26,500	81,500	51.5	447.6		75,400	250
255	46.6	431.4	29,700	82,600	48.2	436.6	24,300	78,600	50.4	443.5		72,700	255
260	45.4	426.4	27,400	79,800	47.0	431.9	22,100	75,800	49.2	439.1		70,000	260
265	44.2	421.3	25,200	77,000	45.8	427.0	20,100	73,200	48.0	434.6		67,500	265
270	42.9	415.9	23,100	74,400	44.5	421.9		70,600	46.9	429.9		65,000	270
275	41.6	410.2	21,100	71,800	43.3	416.6		68,100	45.6	425.0		62,600	275
280	40.3	404.3		69,300	42.0	411.0		65,700	44.4	419.8		60,300	280
290	37.5	391.5		64,700	39.3	399.0		61,200	41.8	408.9		56,000	290
300	34.5	377.3		60,300	36.4	385.8		56,900	39.1	396.8		51,900	300
310	31.2	361.4		56,200	33.3	371.0		52,900	36.3	383.5		48,100	310
320	27.6	343.0		52,300	29.9	354.3		49,200	33.2	368.7		44,500	320
330	23.5	321.4		48,700	26.2	334.9		45,700	29.8	351.8		41,100	330
340	18.4	294.1		45,200	21.8	311.6		42,300	26.0	332.3		37,900	340
350	11.4	254.4		40,100	16.3	281.2		39,100	21.5	308.7		34,900	350
360					7.1	229.4		34,700	15.9	277.9		32,000	360
370									6.3	223.1		29,100	370
380													380

# MLC650 VPC-MAX S-1

ASME B30.5

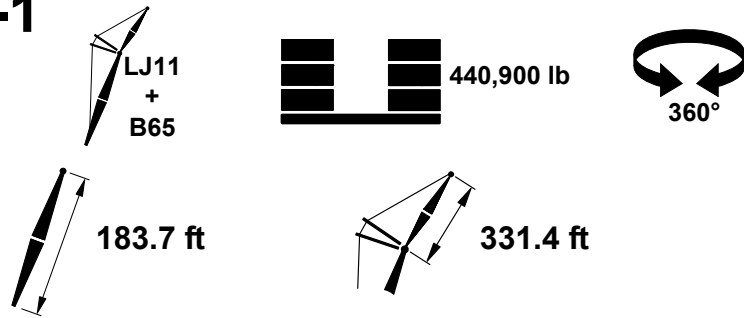

ft	75°			70°			65°			ft
	°	ft	lb	°	ft	lb	°	ft	lb	
115										115
120										120
125										125
130										130
135										135
140										140
145										145
150										150
155										155
160										160
165										165
170										170
175										175
180										180
185										185
190										190
195										195
200	65.0	485.8	98,300							200
205	64.0	483.3	94,300							205
210	63.0	480.7	90,500							210
215	62.1	478.0	86,800							215
220	61.1	475.2	83,300							220
225	60.1	472.3	80,000							225
230	59.1	469.3	76,900							230
235	58.0	466.2	73,800							235
240	57.0	462.9	70,900							240
245	56.0	459.5	68,100	59.1	464.4	58,200				245
250	54.9	455.9	65,500	58.1	461.2	55,700				250
255	53.8	452.2	62,900	57.1	457.9	53,400				255
260	52.7	448.4	60,400	56.0	454.5	51,100				260
265	51.6	444.4	58,100	54.9	451.0	48,900				265
270	50.5	440.3	55,800	53.9	447.3	46,800				270
275	49.4	435.9	53,600	52.8	443.5	44,700				275
280	48.2	431.4	51,400	51.7	439.5	42,800	54.9	444.4	34,400	280
290	45.8	421.8	47,400	49.4	431.0	39,100	52.7	436.9	31,000	290
300	43.3	411.4	43,600	47.1	421.9	35,600	50.5	428.7	27,800	300
310	40.7	400.0	40,100	44.6	411.9	32,300	48.2	419.9	24,800	310
320	37.9	387.4	36,800	42.1	401.0	29,300	45.8	410.3	21,900	320
330	34.9	373.5	33,700	39.4	389.1	26,400				330
340	31.7	357.8	30,700	36.5	375.9	23,700				340
350	28.2	339.9	27,900	33.4	361.2	21,100				350
360	24.1	318.8	25,300							360
370	19.3	292.7	22,700							370
380	12.7	256.0	20,200							380

# MLC650 VPC-MAX S-1

ASME B30.5

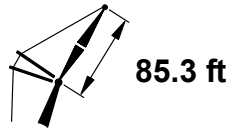
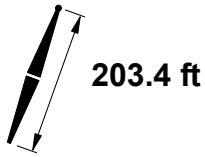

ft	85°				83°				80°				ft
	ft	lb	lb	lb	ft	lb	lb	lb	ft	lb	lb	lb	
55	73.1	293.5	451,700 c	732,600 c									55
60	69.5	291.5	406,800 c	673,900 c									60
65	65.8	289.1	369,300 c	611,100 c	71.0	291.5	350,700 c	596,200 c					65
70	61.9	286.3	337,500 b	558,500 b	67.3	289.3	320,400 c	544,900 c					70
75	57.9	283.1	310,200 b	513,900 b	63.6	286.7	294,400 b	501,300 b					75
80	53.7	279.3	286,400	475,500	59.6	283.6	271,800 b	463,800 b	67.7	287.8	249,800 b	446,500 b	80
85	49.3	274.9	265,600	442,100	55.5	280.1	251,900 b	431,300 b	64.0	285.2	231,400 b	415,000 b	85
90	44.4	269.7	247,000	412,800	51.1	275.9	234,300	402,700	60.1	282.2	215,200 b	387,500 b	90
95	39.1	263.4	230,400	386,900	46.5	271.1	218,600	377,300	56.0	278.7	200,600 b	363,100 b	95
100	32.9	255.7	215,400	363,700	41.4	265.3	204,400	354,700	51.6	274.7	187,600	341,400	100
105	25.3	245.5	201,600	342,800	35.6	258.3	191,500	334,400	47.0	269.9	175,800	321,800	105
110	13.3	228.4	188,400	318,000	28.7	249.3	179,600	316,000	41.9	264.2	164,900	304,200	110
115					19.3	236.3	168,400	299,200	36.2	257.4	155,000	288,100	115
120									29.5	248.7	145,700	273,500	120
125									20.6	236.3	136,900	259,900	125
130													130
135													135
140													140
145													145
150													150
155													155
160													160
165													165
170													170
175													175



# MLC650 VPC-MAX S-1

ASME B30.5

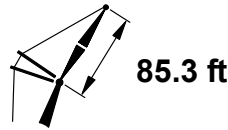
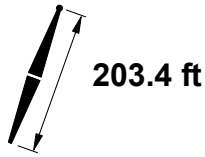

ft	75°				70°				65°				ft
	ft	ft	lb	lb	ft	ft	lb	lb	ft	ft	lb	lb	
55													55
60													60
65													65
70													70
75													75
80													80
85													85
90													90
95													95
100													100
105													105
110	61.9	279.6	149,100 b	301,000 b									110
115	57.9	276.3	139,800 b	284,500 b									115
120	53.7	272.5	131,300 b	269,500 b									120
125	49.2	268.1	123,500	255,800									125
130	44.3	262.8	116,200	243,300	59.4	272.0	94,700	226,600					130
135	39.0	256.6	109,400	231,700	55.3	268.4	89,000	215,800					135
140	32.8	248.9	103,000	221,000	50.9	264.2	83,700	205,900					140
145	25.1	238.6	96,900	211,000	46.2	259.3	78,700	196,700					145
150	13.0	221.3	90,600	201,400	41.1	253.5	74,000	188,100					150
155					35.2	246.4	69,500	180,000	52.1	258.3	52,700	167,000	155
160					28.3	237.3	65,200	172,400	47.5	253.6	49,200	160,100	160
165					18.7	223.9	60,800	165,200	42.5	248.1	45,900	153,500	165
170									36.9	241.4	42,700	147,300	170
175									30.3	232.9	39,600	141,500	175
175									21.7	221.1	36,500	135,800	175

# MLC650 VPC-MAX S-1

ASME B30.5

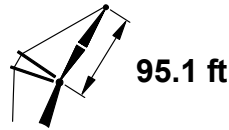
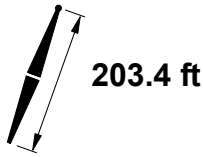

ft	85°				83°				80°				ft
	ft	lb	lb	lb	ft	lb	lb	lb	ft	lb	lb	lb	
55	74.9	303.8	449,100 c	721,900 c									55
60	71.7	302.1	404,300 c	670,000 c									60
65	68.5	300.0	366,900 c	607,600 c									65
70	65.1	297.6	335,200 b	555,300 b	69.8	300.1	317,700 b	541,500 b					70
75	61.7	294.8	307,900 b	510,900 b	66.5	297.8	291,800 b	498,100 b					75
80	58.1	291.6	284,300	472,800	63.1	295.1	269,300 b	460,900 b					80
85	54.4	287.9	263,500	439,600	59.6	292.1	249,500 b	428,500 b	66.9	296.3	228,500 b	412,000 b	85
90	50.4	283.6	245,100	410,400	55.9	288.6	232,000	400,000	63.5	293.7	212,300 b	384,600 b	90
95	46.2	278.8	228,700	384,600	52.1	284.6	216,400	374,900	60.0	290.7	197,900 b	360,400 b	95
100	41.7	273.1	213,900	361,600	48.0	280.0	202,400	352,400	56.3	287.3	185,000	338,800	100
105	36.6	266.3	200,500	341,000	43.6	274.7	189,700	332,300	52.5	283.3	173,300	319,400	105
110	30.8	258.0	188,200	322,300	38.8	268.4	178,100	314,100	48.4	278.8	162,700	301,900	110
115	23.5	247.0	176,800	305,200	33.3	260.8	167,500	297,600	44.1	273.5	152,900	286,000	115
120	11.8	228.3	165,700	287,900	26.7	251.1	157,500	282,400	39.3	267.4	143,900	271,500	120
125					17.8	237.1	148,100	268,400	33.9	259.9	135,600	258,200	125
130									27.5	250.6	127,700	245,900	130
135									19.0	237.2	120,200	234,400	135
140													140
145													145
150													150
155													155
160													160
165													165
170													170
175													175
180													180
185													185

# MLC650 VPC-MAX S-1

ASME B30.5

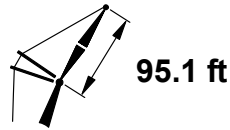
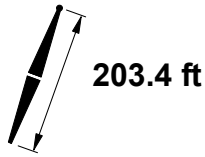

ft	75°				70°				65°				ft			
	ft	°	ft	lb	lb	ft	°	ft	lb	lb	ft	°		ft	lb	lb
55																55
60																60
65																65
70																70
75																75
80																80
85																85
90																90
95																95
100																100
105																105
110	61.6	288.0	136,700	281,700												110
115	58.0	284.8	128,300	266,800												115
120	54.3	281.1	120,600	253,300												120
125	50.4	276.8	113,500	240,800												125
130	46.1	271.9	106,900	229,400	59.4	280.4	85,700	213,100								130
135	41.6	266.2	100,700	218,800	55.7	276.9	80,600	203,300								135
140	36.5	259.4	94,900	209,000	51.9	272.9	75,700	194,100								140
145	30.6	251.1	89,400	199,900	47.8	268.3	71,200	185,700								145
150	23.3	240.0	84,100	191,300	43.4	262.9	66,900	177,800								150
155	11.5	221.0	78,600	183,000	38.5	256.5	62,800	170,300	52.9	267.0	46,000	157,500				155
160					33.0	248.9	58,900	163,400	48.9	262.5	42,900	151,000				160
165					26.3	239.0	55,100	156,700	44.6	257.3	39,900	145,000				165
170					17.1	224.6	51,200	150,400	39.8	251.3	37,000	139,200				170
175									34.5	244.0	34,200	133,800				175
180									28.3	234.9	31,400	128,600				180
185									20.1	222.2	28,600	123,600				185

# MLC650 VPC-MAX S-1

ASME B30.5

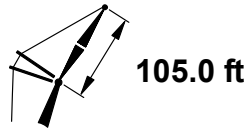
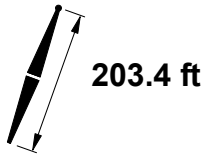

ft	85°				83°				80°				ft
	ft	lb	lb	lb	ft	lb	lb	lb	ft	lb	lb	lb	
60	73.5	312.5	402,900 c	663,000 c									60
65	70.6	310.7	365,600 b	604,900 b									65
70	67.6	308.5	333,900 b	553,000 b	71.8	310.6	316,200 b	539,000 b					70
75	64.6	306.1	306,800 b	508,800 b	68.9	308.6	290,300 b	495,900 b					75
80	61.5	303.3	283,200 b	470,800 b	65.9	306.3	267,900 b	458,800 b					80
85	58.2	300.1	262,500	437,800	62.8	303.6	248,200 b	426,600 b	69.2	307.1	226,800 b	409,900 b	85
90	54.9	296.4	244,200	408,800	59.6	300.6	230,800	398,300	66.2	304.8	210,800 b	382,700 b	90
95	51.4	292.4	227,900	383,200	56.3	297.1	215,300	373,300	63.1	302.2	196,500 b	358,600 b	95
100	47.6	287.7	213,300	360,300	52.8	293.3	201,400	351,000	59.9	299.2	183,600	337,100	100
105	43.6	282.4	200,000	339,800	49.2	288.8	188,800	330,900	56.6	295.8	172,000	317,800	105
110	39.3	276.2	187,900	321,200	45.3	283.8	177,400	312,900	53.2	292.0	161,500	300,400	110
115	34.5	268.9	176,900	304,400	41.2	278.0	166,900	296,500	49.6	287.6	151,900	284,600	115
120	28.9	260.0	166,600	289,000	36.6	271.3	157,300	281,500	45.8	282.7	143,000	270,200	120
125	22.0	248.3	157,000	274,800	31.4	263.1	148,300	267,700	41.6	277.0	134,800	257,000	125
130	10.5	227.9	147,500	261,600	25.1	252.8	139,900	255,100	37.1	270.3	127,200	244,900	130
135					16.4	237.7	131,800	243,200	32.0	262.3	120,100	233,700	135
140									25.8	252.3	113,400	223,200	140
145									17.6	238.0	106,900	213,400	145
150													150
155													155
160													160
165													165
170													170
175													175
180													180
185													185
190													190
195													195

# MLC650 VPC-MAX S-1

ASME B30.5

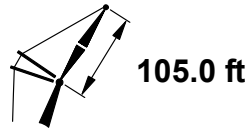
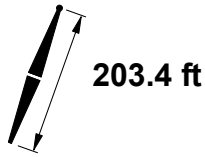

ft	75°				70°				65°				ft
	ft	°	ft	lb	ft	°	ft	lb	ft	°	ft	lb	
60													60
65													65
70													70
75													75
80													80
85													85
90													90
95													95
100													100
105													105
110	64.6	299.3	135,000	279,900									110
115	61.4	296.5	126,700	265,200									115
120	58.2	293.3	119,100	251,700									120
125	54.8	289.7	112,000	239,400									125
130	51.3	285.6	105,500	228,000									130
135	47.6	280.9	99,500	217,500	59.4	288.9	78,800	201,700					135
140	43.6	275.6	93,900	207,800	56.1	285.5	74,000	192,600					140
145	39.2	269.4	88,600	198,800	52.6	281.6	69,600	184,200					145
150	34.4	262.1	83,600	190,400	49.0	277.1	65,400	176,400					150
155	28.8	253.1	78,800	182,500	45.1	272.1	61,500	169,100					155
160	21.8	241.3	74,100	175,000	40.9	266.2	57,800	162,200	53.6	275.6	41,100	149,500	160
165	10.2	220.6	69,200	167,700	36.3	259.4	54,200	155,800	50.0	271.3	38,200	143,600	165
170					31.1	251.1	50,700	149,600	46.2	266.4	35,500	137,900	170
175					24.7	240.6	47,400	143,800	42.1	260.8	32,800	132,600	175
180					15.8	225.1	43,900	138,200	37.6	254.3	30,300	127,600	180
185									32.5	246.4	27,800	122,700	185
190									26.6	236.7	25,300	118,100	190
195									18.6	223.1	22,800	113,600	195

# MLC650 VPC-MAX S-1

ASME B30.5

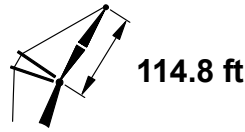
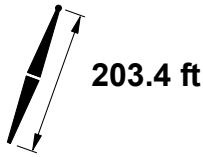

ft	85°				83°				80°				ft
	°	ft	lb	lb	°	ft	lb	lb	°	ft	lb	lb	
60	75.0	322.9	400,200 b	623,800 b									60
65	72.4	321.2	363,000 b	601,400 b									65
70	69.7	319.3	331,400 b	549,700 b									70
75	67.0	317.1	304,300 b	505,800 b	70.8	319.3	287,500 b	492,700 b					75
80	64.2	314.6	280,800	468,000	68.1	317.2	265,200 b	455,800 b					80
85	61.3	311.7	260,200	435,100	65.3	314.8	245,600	423,700					85
90	58.4	308.6	241,900	406,300	62.5	312.1	228,300	395,600	68.4	315.7	207,800	379,700	90
95	55.3	305.0	225,700	380,700	59.6	309.1	212,800	370,700	65.6	313.3	193,600	355,700	95
100	52.1	301.0	211,100	358,000	56.6	305.7	199,000	348,500	62.8	310.6	180,800	334,400	100
105	48.8	296.6	198,000	337,500	53.4	301.9	186,500	328,600	59.9	307.7	169,300	315,200	105
110	45.2	291.5	186,000	319,100	50.2	297.6	175,100	310,600	56.9	304.3	158,800	297,900	110
115	41.4	285.8	175,100	302,400	46.7	292.8	164,800	294,300	53.8	300.6	149,300	282,200	115
120	37.3	279.2	165,000	287,100	43.0	287.4	155,300	279,400	50.5	296.3	140,500	267,900	120
125	32.7	271.4	155,700	273,100	39.1	281.2	146,500	265,800	47.1	291.6	132,400	254,800	125
130	27.3	261.9	147,000	260,200	34.7	273.9	138,300	253,200	43.4	286.3	125,000	242,800	130
135	20.6	249.4	138,800	248,200	29.7	265.3	130,700	241,600	39.5	280.2	118,000	231,600	135
140	9.3	227.3	130,500	237,000	23.7	254.3	123,500	230,800	35.2	273.0	111,500	221,300	140
145					15.2	238.2	116,400	220,700	30.3	264.6	105,400	211,700	145
150									24.4	253.9	99,500	202,700	150
155									16.4	238.6	93,800	194,200	155
160													160
165													165
170													170
175													175
180													180
185													185
190													190
195													195
200													200
205													205

# MLC650 VPC-MAX S-1

ASME B30.5

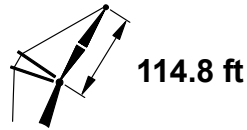
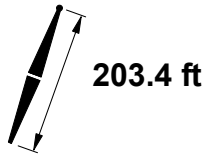

ft	75°				70°				65°				ft
	ft	°	ft	lb	ft	°	ft	lb	ft	°	ft	lb	
60													60
65													65
70													70
75													75
80													80
85													85
90													90
95													95
100													100
105													105
110													110
115	64.1	307.8	123,500	262,400									115
120	61.3	305.0	116,000	249,000									120
125	58.3	301.8	109,000	236,700									125
130	55.2	298.2	102,600	225,500									130
135	52.1	294.2	96,700	215,100									135
140	48.7	289.8	91,100	205,500	59.4	297.4	70,800	189,900					140
145	45.2	284.7	85,900	196,500	56.4	294.0	66,400	181,600					145
150	41.4	279.0	81,100	188,200	53.3	290.2	62,300	173,900					150
155	37.2	272.3	76,500	180,400	50.0	285.9	58,500	166,600					155
160	32.6	264.6	72,100	173,100	46.5	281.1	54,900	159,800					160
165	27.3	255.0	67,900	166,200	42.8	275.6	51,400	153,500	54.1	284.2	35,000	140,900	165
170	20.5	242.5	63,700	159,600	38.8	269.3	48,100	147,500	50.9	280.0	32,300	135,400	170
175	9.0	219.9	59,300	153,200	34.4	262.0	45,000	141,800	47.5	275.3	29,700	130,100	175
180					29.4	253.3	41,900	136,400	43.8	270.1	27,300	125,200	180
185					23.3	242.1	38,900	131,200	39.9	264.0	25,000	120,500	185
190					14.6	225.5	35,800	126,200	35.7	257.0	22,700	116,000	190
195									30.8	248.7	20,500	111,700	195
200									25.1	238.4		107,600	200
205									17.4	223.8		103,500	205

# MLC650 VPC-MAX S-1

ASME B30.5

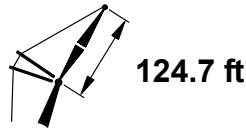
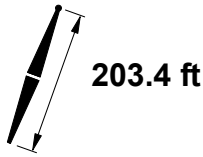

ft	85°				83°				80°				ft
	ft	lb	lb	lb	ft	lb	lb	lb	ft	lb	lb	lb	
65	73.8	331.6	426,100 b	561,600 b									65
70	71.4	329.9	389,700 b	548,400 b									70
75	68.9	327.8	358,500 b	504,700 b	72.4	329.8	341,500 b	491,500 b					75
80	66.4	325.6	331,400	467,100	69.9	327.9	315,600 b	454,800 b					80
85	63.8	323.0	307,700	434,400	67.4	325.7	292,900	422,900					85
90	61.2	320.2	286,800	405,600	64.9	323.3	272,900	394,900					90
95	58.4	317.0	268,100	380,200	62.3	320.6	255,000	370,100	67.7	324.2	235,500	355,100	95
100	55.6	313.5	251,400	357,600	59.6	317.5	239,000	348,000	65.1	321.8	220,600	333,800	100
105	52.7	309.7	236,300	337,200	56.8	314.2	224,600	328,200	62.5	319.1	207,100	314,800	105
110	49.7	305.3	222,600	318,900	53.9	310.5	211,500	310,300	59.9	316.1	194,900	297,500	110
115	46.5	300.5	210,100	302,200	51.0	306.3	199,600	294,100	57.1	312.8	183,800	281,900	115
120	43.1	295.1	198,700	287,100	47.8	301.7	188,700	279,300	54.3	309.1	173,600	267,700	120
125	39.5	289.0	188,100	273,200	44.5	296.6	178,600	265,700	51.3	305.0	164,200	254,700	125
130	35.5	282.0	178,400	260,400	41.0	290.8	169,300	253,300	48.2	300.5	155,600	242,700	130
135	31.1	273.8	169,300	248,600	37.2	284.2	160,700	241,800	44.9	295.4	147,600	231,600	135
140	26.0	263.7	160,800	237,600	33.0	276.5	152,600	231,100	41.4	289.7	140,100	221,400	140
145	19.5	250.5	152,700	227,400	28.2	267.3	145,000	221,200	37.6	283.2	133,100	211,900	145
150	8.2	226.5	144,500	217,600	22.4	255.7	137,800	211,900	33.5	275.6	126,600	203,000	150
155					14.2	238.5	130,800	203,100	28.8	266.6	120,400	194,700	155
160									23.1	255.3	114,400	186,900	160
165									15.3	239.1	108,600	179,500	165
170													170
175													175
180													180
185													185
190													190
195													195
200													200
205													205
210													210
215													215



# MLC650 VPC-MAX S-1

ASME B30.5

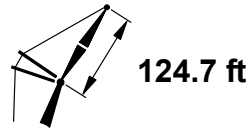
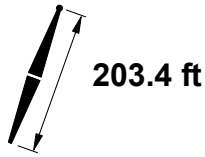

ft	75°				70°				65°				ft
	ft	°	ft	lb	ft	°	ft	lb	ft	°	ft	lb	
65													65
70													70
75													75
80													80
85													85
90													90
95													95
100													100
105													105
110													110
115													115
120	63.8	316.3	148,700	248,700									120
125	61.1	313.4	140,400	236,500									125
130	58.4	310.3	132,800	225,300									130
135	55.6	306.8	125,800	214,900									135
140	52.7	302.9	119,200	205,400									140
145	49.6	298.5	113,100	196,500	59.4	305.9	93,300	181,400					145
150	46.4	293.7	107,400	188,200	56.7	302.5	88,300	173,700					150
155	43.1	288.3	102,000	180,500	53.8	298.8	83,700	166,500					155
160	39.4	282.2	97,000	173,300	50.8	294.6	79,300	159,800					160
165	35.5	275.1	92,200	166,500	47.7	290.0	75,200	153,500					165
170	31.0	266.9	87,600	160,100	44.4	284.8	71,200	147,500	54.6	292.7	55,100	135,300	170
175	25.9	256.8	83,200	154,000	40.8	279.0	67,500	141,900	51.6	288.7	51,900	130,100	175
180	19.3	243.5	78,900	148,200	37.0	272.3	64,000	136,600	48.5	284.2	48,900	125,200	180
185	7.8	219.0	74,200	142,400	32.8	264.5	60,600	131,600	45.3	279.2	46,000	120,500	185
190					27.9	255.3	57,300	126,800	41.8	273.5	43,300	116,100	190
195					22.0	243.5	54,000	122,200	38.1	267.1	40,700	111,900	195
200					13.6	225.7	50,700	117,600	34.0	259.7	38,100	107,900	200
205									29.3	250.9	35,700	104,000	205
210									23.8	239.9	33,200	100,300	210
215									16.3	224.5	30,700	96,700	215

# MLC650 VPC-MAX S-1

ASME B30.5

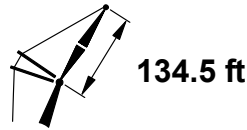
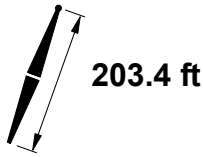

ft	85°				83°				80°				ft
	ft	lb	lb	lb	ft	lb	lb	lb	ft	lb	lb	lb	
70	72.8	340.3	387,200 b	528,700 b									70
75	70.5	338.5	356,000	501,700									75
80	68.2	336.4	329,000	464,200	71.5	338.4	312,900	451,800					80
85	65.9	334.1	305,300	431,700	69.2	336.4	290,200	420,100					85
90	63.5	331.5	284,400	403,100	66.9	334.2	270,200	392,200					90
95	61.0	328.7	265,800	377,800	64.5	331.8	252,400	367,500	69.4	334.9	232,500	352,300	95
100	58.5	325.5	249,100	355,200	62.1	329.0	236,500	345,500	67.1	332.7	217,700	331,100	100
105	55.9	322.1	234,000	334,900	59.6	326.0	222,100	325,800	64.7	330.3	204,300	312,100	105
110	53.3	318.3	220,400	316,700	57.0	322.7	209,100	308,000	62.3	327.6	192,100	295,000	110
115	50.5	314.1	208,000	300,100	54.4	319.0	197,200	291,800	59.8	324.6	181,100	279,500	115
120	47.6	309.4	196,600	285,000	51.6	315.0	186,300	277,100	57.3	321.3	170,900	265,300	120
125	44.5	304.3	186,100	271,200	48.8	310.5	176,300	263,600	54.7	317.7	161,600	252,300	125
130	41.3	298.5	176,500	258,400	45.8	305.6	167,100	251,200	51.9	313.7	153,100	240,400	130
135	37.8	292.0	167,500	246,700	42.6	300.1	158,600	239,800	49.1	309.3	145,100	229,400	135
140	34.0	284.6	159,100	235,800	39.3	294.0	150,600	229,200	46.1	304.4	137,700	219,300	140
145	29.7	275.9	151,300	225,700	35.6	287.0	143,200	219,300	43.0	299.0	130,800	209,800	145
150	24.7	265.4	143,900	216,300	31.5	278.9	136,200	210,200	39.6	292.9	124,400	201,000	150
155	18.4	251.4	136,800	207,400	26.9	269.2	129,600	201,600	36.0	286.0	118,300	192,800	155
160	7.1	225.3	129,500	198,900	21.3	256.9	123,200	193,500	32.0	278.1	112,500	185,100	160
165					13.2	238.7	117,000	185,800	27.4	268.6	107,100	177,800	165
170									21.9	256.7	101,800	171,000	170
175									14.3	239.5	96,600	164,400	175
180													180
185													185
190													190
195													195
200													200
205													205
210													210
215													215
220													220
225													225

# MLC650 VPC-MAX S-1

ASME B30.5

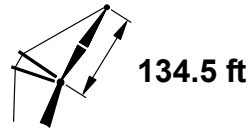
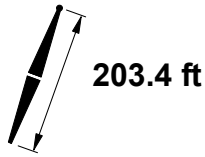

ft	75°				70°				65°				ft
	ft	ft	lb	lb	ft	ft	lb	lb	ft	ft	lb	lb	
70													70
75													75
80													80
85													85
90													90
95													95
100													100
105													105
110													110
115													115
120													120
125	63.4	324.7	137,400	233,800									125
130	61.0	321.9	129,800	222,700									130
135	58.5	318.8	122,800	212,400									135
140	55.9	315.3	116,300	202,900									140
145	53.2	311.5	110,300	194,100									145
150	50.4	307.3	104,600	185,900	59.4	314.4	85,100	171,100					150
155	47.5	302.6	99,300	178,200	56.9	311.0	80,500	164,000					155
160	44.5	297.5	94,300	171,100	54.2	307.3	76,200	157,300					160
165	41.2	291.7	89,600	164,300	51.5	303.3	72,100	151,000					165
170	37.7	285.2	85,200	158,000	48.6	298.8	68,300	145,200					170
175	33.9	277.8	80,900	152,000	45.6	293.9	64,700	139,600	54.9	301.3	48,700	127,500	175
180	29.6	269.1	76,900	146,300	42.5	288.3	61,200	134,400	52.2	297.3	45,700	122,700	180
185	24.6	258.5	72,900	140,900	39.1	282.1	57,900	129,400	49.4	293.0	42,900	118,100	185
190	18.3	244.4	69,000	135,800	35.4	275.1	54,800	124,700	46.5	288.2	40,300	113,700	190
195	6.7	217.7	64,800	130,600	31.3	266.9	51,700	120,200	43.3	282.8	37,700	109,600	195
200					26.6	257.1	48,800	115,900	40.0	276.8	35,300	105,600	200
205					20.9	244.7	45,800	111,700	36.4	270.0	32,900	101,800	205
210					12.6	225.9	42,800	107,700	32.4	262.1	30,600	98,200	210
215									28.0	252.9	28,400	94,800	215
220									22.6	241.3	26,200	91,400	220
225									15.3	225.0	23,800	88,100	225

# MLC650 VPC-MAX S-1

ASME B30.5

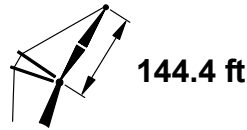
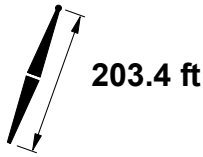

ft	85°				83°				80°				ft
	ft	lb	lb	lb	ft	lb	lb	lb	ft	lb	lb	lb	
70	74.0	350.7	385,300 b	486,200 b									70
75	71.9	349.0	354,200	486,200									75
80	69.8	347.1	327,200	461,900	72.8	348.9	311,000	449,400					80
85	67.6	344.9	303,500	429,400	70.7	347.0	288,400	417,800					85
90	65.4	342.6	282,700	401,000	68.5	345.0	268,400	390,000					90
95	63.2	340.0	264,100	375,800	66.4	342.7	250,600	365,400					95
100	60.9	337.1	247,400	353,300	64.1	340.2	234,700	343,500	68.8	343.5	215,700	329,000	100
105	58.6	334.0	232,400	333,100	61.9	337.5	220,300	323,900	66.6	341.2	202,300	310,100	105
110	56.2	330.6	218,800	314,900	59.6	334.5	207,300	306,100	64.4	338.8	190,200	293,100	110
115	53.7	326.9	206,400	298,400	57.2	331.2	195,500	290,000	62.1	336.1	179,200	277,600	115
120	51.1	322.8	195,100	283,300	54.7	327.6	184,700	275,400	59.8	333.1	169,100	263,500	120
125	48.5	318.3	184,700	269,600	52.2	323.6	174,700	261,900	57.4	329.8	159,800	250,600	125
130	45.7	313.3	175,100	256,900	49.6	319.3	165,500	249,600	55.0	326.2	151,300	238,700	130
135	42.7	307.8	166,200	245,200	46.9	314.6	157,000	238,200	52.5	322.3	143,400	227,800	135
140	39.6	301.8	157,900	234,400	44.0	309.3	149,100	227,700	49.9	318.1	136,000	217,700	140
145	36.3	294.9	150,200	224,400	40.9	303.5	141,800	217,900	47.2	313.3	129,200	208,300	145
150	32.6	287.1	142,900	215,000	37.7	297.0	134,900	208,800	44.3	308.2	122,800	199,500	150
155	28.5	278.0	136,100	206,300	34.1	289.6	128,400	200,300	41.3	302.4	116,800	191,300	155
160	23.6	266.9	129,600	198,100	30.2	281.1	122,300	192,300	38.0	296.0	111,200	183,700	160
165	17.5	252.2	123,300	190,300	25.7	271.0	116,500	184,800	34.5	288.7	105,800	176,500	165
170	6.0	223.8	116,800	181,200	20.3	258.1	110,900	177,700	30.7	280.4	100,800	169,800	170
175					12.4	238.8	105,300	170,900	26.3	270.4	95,900	163,400	175
180									20.9	257.9	91,200	157,300	180
185									13.5	239.8	86,600	151,400	185
190													190
195													195
200													200
205													205
210													210
215													215
220													220
225													225
230													230
235													235

# MLC650 VPC-MAX S-1

ASME B30.5

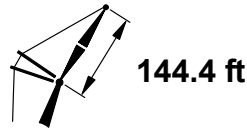
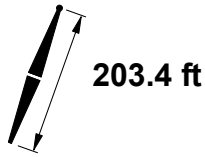

ft	75°				70°				65°				ft
	ft	ft	lb	lb	ft	ft	lb	lb	ft	ft	lb	lb	
70													70
75													75
80													80
85													85
90													90
95													95
100													100
105													105
110													110
115													115
120													120
125													125
130	63.2	333.2	127,800	220,800									130
135	60.9	330.4	120,800	210,600									135
140	58.5	327.2	114,400	201,200									140
145	56.1	323.8	108,300	192,400									145
150	53.7	320.1	102,700	184,200									150
155	51.1	316.0	97,500	176,600	59.4	322.8	78,400	162,200					155
160	48.4	311.5	92,500	169,500	57.1	319.5	74,200	155,600					160
165	45.6	306.5	87,900	162,800	54.6	315.9	70,100	149,300					165
170	42.7	301.0	83,500	156,500	52.1	311.9	66,300	143,500					170
175	39.6	294.9	79,300	150,600	49.4	307.6	62,800	138,000					175
180	36.2	288.1	75,400	145,000	46.7	302.8	59,400	132,800					180
185	32.5	280.3	71,600	139,700	43.8	297.5	56,100	127,900	52.8	306.0	40,900	116,400	185
190	28.4	271.1	67,900	134,600	40.8	291.7	53,000	123,200	50.2	301.7	38,300	112,000	190
195	23.5	260.0	64,400	129,800	37.5	285.1	50,100	118,800	47.4	297.1	35,800	107,900	195
200	17.3	245.2	60,900	125,100	33.9	277.7	47,200	114,500	44.6	291.9	33,400	104,000	200
205	5.5	215.9	57,000	120,400	30.0	269.1	44,500	110,500	41.6	286.2	31,100	100,300	205
210					25.5	258.9	41,800	106,600	38.4	279.9	28,900	96,800	210
215					19.9	245.8	39,100	102,900	34.9	272.7	26,700	93,400	215
220					11.8	225.9	36,300	99,200	31.1	264.5	24,700	90,100	220
225									26.8	254.8	22,600	87,000	225
230									21.6	242.6	20,600	83,900	230
235									14.5	225.5		80,900	235

# MLC650 VPC-MAX S-1

ASME B30.5



**440,900 lb**

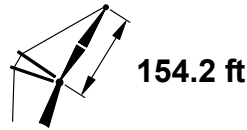
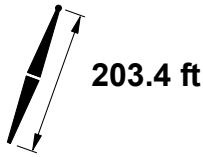

ft	85°				83°				80°				ft
	ft	lb	lb	lb	ft	lb	lb	lb	ft	lb	lb	lb	
75	73.1	359.4	351,700	448,900									75
80	71.1	357.6	324,700	448,900									80
85	69.2	355.7	301,100	426,800	72.0	357.5	285,600	415,000					85
90	67.1	353.5	280,200	398,400	70.0	355.6	265,700	387,300					90
95	65.1	351.1	261,700	373,300	68.0	353.5	248,000	362,800					95
100	63.0	348.5	245,100	350,900	65.9	351.2	232,100	341,000					100
105	60.8	345.6	230,100	330,800	63.8	348.7	217,800	321,400	68.2	352.0	199,500	307,500	105
110	58.6	342.5	216,500	312,700	61.7	346.0	204,800	303,800	66.1	349.8	187,400	290,500	110
115	56.4	339.1	204,200	296,200	59.6	343.0	193,000	287,700	64.1	347.3	176,400	275,100	115
120	54.1	335.4	192,900	281,200	57.3	339.7	182,200	273,100	62.0	344.5	166,400	261,100	120
125	51.7	331.4	182,500	267,500	55.1	336.1	172,300	259,700	59.8	341.6	157,200	248,200	125
130	49.2	327.0	172,900	254,900	52.7	332.3	163,200	247,500	57.6	338.3	148,700	236,400	130
135	46.7	322.3	164,100	243,300	50.3	328.0	154,700	236,100	55.3	334.8	140,800	225,500	135
140	44.0	317.0	155,800	232,500	47.8	323.4	146,900	225,600	53.0	330.9	133,500	215,400	140
145	41.2	311.3	148,200	222,500	45.1	318.4	139,600	215,900	50.5	326.8	126,700	206,100	145
150	38.1	304.9	141,000	213,200	42.3	312.9	132,700	206,900	48.0	322.2	120,300	197,400	150
155	34.9	297.7	134,200	204,500	39.4	306.7	126,300	198,400	45.4	317.2	114,400	189,300	155
160	31.3	289.5	127,900	196,400	36.3	299.9	120,300	190,500	42.6	311.7	108,800	181,700	160
165	27.3	280.0	121,900	188,700	32.8	292.2	114,600	183,000	39.7	305.7	103,500	174,500	165
170	22.6	268.4	116,100	181,500	29.0	283.3	109,200	176,000	36.6	298.9	98,600	167,800	170
175	16.6	253.0	110,600	174,600	24.7	272.6	104,000	169,400	33.2	291.3	93,800	161,500	175
180	4.8	221.6	104,600	164,200	19.3	259.2	99,000	163,100	29.5	282.5	89,300	155,500	180
185					11.6	238.8	94,000	157,100	25.2	272.1	85,000	149,900	185
190									20.0	259.1	80,800	144,400	190
195									12.7	240.0	76,600	139,200	195
200													200
205													205
210													210
215													215
220													220
225													225
230													230
235													235
240													240
245													245

# MLC650 VPC-MAX S-1

ASME B30.5

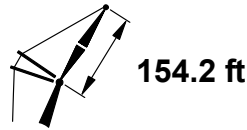
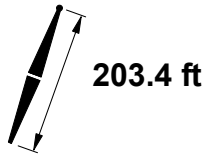

ft	75°				70°				65°				ft
	ft	°	ft	lb	ft	°	ft	lb	ft	°	ft	lb	
75													75
80													80
85													85
90													90
95													95
100													100
105													105
110													110
115													115
120													120
125													125
130													130
135	62.9	341.7	117,800	208,100									135
140	60.8	338.8	111,400	198,700									140
145	58.6	335.7	105,400	190,000									145
150	56.4	332.3	99,900	181,900									150
155	54.1	328.6	94,700	174,300									155
160	51.7	324.6	89,800	167,200	59.4	331.3	71,000	153,000					160
165	49.2	320.2	85,200	160,600	57.2	328.0	67,000	146,900					165
170	46.6	315.5	80,800	154,300	54.9	324.4	63,300	141,100					170
175	43.9	310.2	76,700	148,400	52.6	320.6	59,800	135,600					175
180	41.1	304.4	72,800	142,900	50.1	316.3	56,400	130,400					180
185	38.1	298.0	69,100	137,600	47.6	311.7	53,200	125,600					185
190	34.8	290.8	65,600	132,600	45.0	306.6	50,200	120,900	53.2	314.6	35,100	109,600	190
195	31.3	282.6	62,200	127,900	42.2	301.1	47,300	116,600	50.8	310.4	32,600	105,500	195
200	27.3	273.1	58,900	123,400	39.2	294.9	44,500	112,400	48.3	305.9	30,300	101,600	200
205	22.5	261.4	55,700	119,000	36.1	288.0	41,900	108,400	45.7	301.0	28,100	98,000	205
210	16.5	245.9	52,500	114,800	32.7	280.2	39,300	104,600	42.9	295.5	25,900	94,500	210
215	4.2	213.2	48,900	110,500	28.8	271.3	36,800	101,000	40.0	289.5	23,900	91,100	215
220					24.4	260.5	34,400	97,500	37.0	282.9	21,900	87,900	220
225					19.0	246.8	32,000	94,000	33.6	275.4	20,000	84,800	225
230					11.0	225.8	29,400	90,700	29.9	266.7		81,900	230
235									25.7	256.5		79,000	235
240									20.6	243.8		76,200	240
245									13.6	225.8		73,500	245

# MLC650 VPC-MAX S-1

ASME B30.5



**440,900 lb**

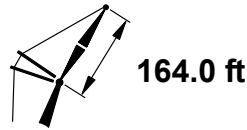
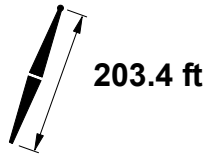

ft	85°				83°				80°				ft
	ft	lb	lb	lb	ft	lb	lb	lb	ft	lb	lb	lb	
75	74.2	369.7	351,000	413,800									75
80	72.3	368.1	324,100	413,800									80
85	70.5	366.2	300,500	413,400									85
90	68.6	364.2	279,600	397,200	71.2	366.2	265,000	386,000					90
95	66.7	362.0	261,100	372,200	69.4	364.2	247,300	361,600					95
100	64.7	359.6	244,500	349,900	67.5	362.1	231,400	339,900					100
105	62.8	356.9	229,600	329,800	65.5	359.8	217,100	320,400	69.6	362.7	198,600	306,400	105
110	60.7	354.1	216,000	311,800	63.6	357.2	204,200	302,800	67.7	360.6	186,600	289,400	110
115	58.7	351.0	203,700	295,400	61.6	354.4	192,400	286,800	65.7	358.3	175,600	274,100	115
120	56.6	347.6	192,400	280,400	59.6	351.4	181,700	272,300	63.8	355.8	165,600	260,100	120
125	54.4	344.0	182,100	266,700	57.5	348.2	171,800	258,900	61.8	353.0	156,400	247,300	125
130	52.2	340.0	172,500	254,200	55.3	344.7	162,700	246,700	59.8	350.0	148,000	235,500	130
135	49.9	335.8	163,700	242,600	53.1	340.9	154,200	235,400	57.7	346.8	140,100	224,700	135
140	47.5	331.1	155,500	231,900	50.9	336.7	146,400	225,000	55.6	343.3	132,900	214,700	140
145	45.1	326.1	147,900	221,900	48.5	332.3	139,100	215,300	53.4	339.5	126,100	205,400	145
150	42.5	320.6	140,700	212,600	46.1	327.4	132,300	206,200	51.1	335.4	119,800	196,700	150
155	39.7	314.5	134,100	204,000	43.5	322.1	126,000	197,800	48.8	331.0	113,900	188,600	155
160	36.8	307.8	127,800	195,900	40.9	316.2	120,000	189,900	46.4	326.2	108,300	181,000	160
165	33.6	300.3	121,900	188,300	38.0	309.8	114,400	182,500	43.8	320.9	103,100	173,900	165
170	30.2	291.8	116,300	181,200	35.0	302.7	109,000	175,600	41.2	315.2	98,200	167,300	170
175	26.3	281.8	110,900	174,400	31.7	294.6	104,000	169,000	38.3	308.8	93,500	161,000	175
180	21.7	269.7	105,800	168,000	28.0	285.3	99,200	162,800	35.3	301.7	89,100	155,100	180
185	15.8	253.6	100,800	161,900	23.7	274.2	94,600	157,000	32.0	293.8	84,900	149,400	185
190	3.2	217.9	95,300	149,000	18.5	260.1	90,100	151,400	28.4	284.6	80,800	144,100	190
195					10.8	238.7	85,600	145,900	24.2	273.8	77,000	139,000	195
200									19.1	260.1	73,200	134,200	200
205									11.9	240.0	69,300	129,500	205
210													210
215													215
220													220
225													225
230													230
235													235
240													240
245													245
250													250
255													255



# MLC650 VPC-MAX S-1

ASME B30.5

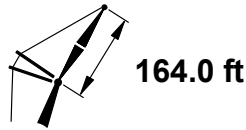
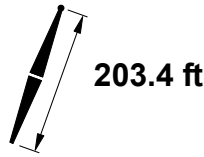

ft	75°				70°				65°				
	ft	lb	lb	lb	ft	lb	lb	lb	ft	lb	lb	ft	
75													75
80													80
85													85
90													90
95													95
100													100
105													105
110													110
115													115
120													120
125													125
130													130
135	64.7	352.8	116,900	207,100									135
140	62.7	350.2	110,500	197,800									140
145	60.7	347.3	104,600	189,100									145
150	58.7	344.2	99,000	181,000									150
155	56.6	340.8	93,900	173,500									155
160	54.4	337.2	89,000	166,400									160
165	52.2	333.3	84,400	159,800	59.4	339.8	66,100	146,000					165
170	49.9	329.0	80,100	153,600	57.4	336.5	62,400	140,200					170
175	47.5	324.3	76,100	147,700	55.2	333.0	58,900	134,800					175
180	45.0	319.3	72,200	142,200	53.0	329.2	55,600	129,700					180
185	42.4	313.8	68,600	137,000	50.8	325.0	52,400	124,800					185
190	39.7	307.7	65,100	132,100	48.4	320.5	49,400	120,200					190
195	36.7	301.0	61,800	127,400	46.0	315.6	46,600	115,900	53.6	323.1	104,700		195
200	33.6	293.5	58,600	122,900	43.4	310.3	43,900	111,700	51.4	319.1	100,900		200
205	30.1	284.9	55,500	118,600	40.7	304.4	41,300	107,800	49.0	314.7	97,200		205
210	26.2	274.9	52,600	114,600	37.9	298.0	38,800	104,000	46.6	309.9	93,700		210
215	21.6	262.8	49,700	110,600	34.8	290.8	36,400	100,400	44.1	304.7	90,400		215
220	15.7	246.6	46,700	106,800	31.5	282.6	34,000	97,000	41.4	299.0	87,300		220
225					27.8	273.3	31,800	93,700	38.6	292.7	84,200		225
230					23.5	262.1	29,500	90,500	35.6	285.7	81,300		230
235					18.2	247.8	27,300	87,400	32.4	277.9	78,500		235
240					10.2	225.5	24,900	84,300	28.8	268.9	75,800		240
245									24.7	258.2	73,200		245
250									19.7	245.0	70,600		250
255									12.9	226.0	68,100		255

# MLC650 VPC-MAX S-1

ASME B30.5

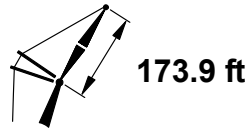
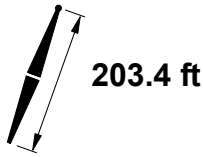

ft	85°				83°				80°				ft
	ft	lb	lb	lb	ft	lb	lb	lb	ft	lb	lb	lb	
80	73.4	378.5	321,600	381,700									80
85	71.6	376.8	298,000	381,600									85
90	69.9	374.9	277,200	380,800	72.3	376.6	262,300	378,400					90
95	68.1	372.8	258,700	369,700	70.6	374.8	244,600	359,100					95
100	66.3	370.5	242,100	347,500	68.8	372.8	228,800	337,400					100
105	64.4	368.1	227,200	327,500	67.0	370.6	214,600	318,000					105
110	62.6	365.4	213,700	309,500	65.2	368.3	201,700	300,400	69.0	371.3	183,800	286,900	110
115	60.7	362.6	201,400	293,200	63.4	365.7	189,900	284,500	67.2	369.1	172,800	271,600	115
120	58.7	359.5	190,100	278,300	61.5	362.9	179,200	270,000	65.4	366.8	162,900	257,700	120
125	56.8	356.1	179,800	264,700	59.5	359.9	169,300	256,700	63.6	364.2	153,700	244,900	125
130	54.7	352.5	170,300	252,100	57.6	356.7	160,200	244,500	61.7	361.5	145,300	233,200	130
135	52.6	348.7	161,500	240,600	55.6	353.2	151,800	233,300	59.8	358.5	137,500	222,400	135
140	50.5	344.5	153,300	229,900	53.5	349.4	144,000	222,900	57.8	355.3	130,200	212,400	140
145	48.3	340.0	145,700	220,000	51.4	345.4	136,800	213,200	55.8	351.8	123,500	203,200	145
150	46.0	335.1	138,600	210,700	49.2	341.0	130,000	204,200	53.7	348.1	117,200	194,500	150
155	43.6	329.8	132,000	202,100	46.9	336.3	123,700	195,800	51.6	344.1	111,400	186,500	155
160	41.1	324.0	125,700	194,100	44.6	331.2	117,800	188,000	49.4	339.8	105,800	179,000	160
165	38.4	317.7	119,900	186,500	42.1	325.6	112,200	180,600	47.2	335.1	100,700	171,900	165
170	35.6	310.7	114,300	179,400	39.5	319.5	106,900	173,700	44.8	330.0	95,800	165,300	170
175	32.5	302.8	109,100	172,700	36.8	312.8	101,900	167,200	42.4	324.5	91,200	159,000	175
180	29.1	293.9	104,100	166,400	33.8	305.3	97,200	161,100	39.8	318.4	86,800	153,100	180
185	25.4	283.6	99,300	160,400	30.6	296.9	92,700	155,200	37.1	311.8	82,600	147,500	185
190	20.9	271.0	94,700	154,700	27.0	287.2	88,400	149,700	34.1	304.4	78,700	142,300	190
195	15.1	254.2	90,200	149,200	22.9	275.7	84,200	144,500	30.9	296.1	74,900	137,200	195
200					17.7	261.0	80,200	139,400	27.4	286.6	71,300	132,500	200
205					10.1	238.4	76,000	134,500	23.3	275.3	67,800	127,900	205
210									18.4	261.1	64,300	123,500	210
215									11.2	240.0	60,800	119,200	215
220													220
225													225
230													230
235													235
240													240
245													245
250													250
255													255
260													260
265													265

# MLC650 VPC-MAX S-1

ASME B30.5

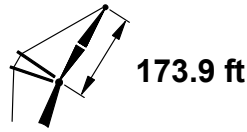
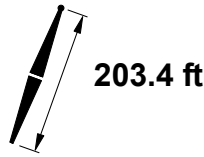

ft	75°				70°				65°				
	ft	lb	ft	lb	ft	lb	ft	lb	ft	lb	ft	lb	
80													80
85													85
90													90
95													95
100													100
105													105
110													110
115													115
120													120
125													125
130													130
135													135
140	64.4	361.3	107,500	195,300									140
145	62.5	358.7	101,600	186,600									145
150	60.6	355.8	96,100	178,600									150
155	58.7	352.7	91,000	171,100									155
160	56.7	349.3	86,200	164,100									160
165	54.7	345.7	81,600	157,500									165
170	52.6	341.9	77,400	151,300	59.4	348.3	59,300	137,800					170
175	50.5	337.7	73,300	145,500	57.5	345.0	55,800	132,400					175
180	48.2	333.2	69,500	140,000	55.5	341.5	52,600	127,300					180
185	45.9	328.3	65,900	134,900	53.4	337.8	49,400	122,500					185
190	43.5	323.0	62,500	130,000	51.3	333.7	46,500	117,900					190
195	41.0	317.2	59,200	125,300	49.1	329.3	43,700	113,600					195
200	38.4	310.8	56,100	120,900	46.8	324.5	41,000	109,500	54.0	331.7	98,400		200
205	35.5	303.8	53,100	116,600	44.5	319.4	38,500	105,600	51.9	327.7	94,800		205
210	32.5	296.0	50,200	112,600	42.0	313.8	36,000	101,900	49.7	323.4	91,400		210
215	29.1	287.1	47,500	108,800	39.4	307.7	33,700	98,300	47.4	318.8	88,100		215
220	25.3	276.7	44,800	105,100	36.6	300.9	31,400	94,900	45.1	313.7	85,000		220
225	20.8	264.0	42,100	101,500	33.6	293.4	29,200	91,700	42.7	308.3	82,000		225
230	15.0	247.1	39,400	98,000	30.4	284.9	27,100	88,500	40.1	302.3	79,100		230
235					26.8	275.2	25,000	85,500	37.4	295.7	76,300		235
240					22.6	263.5	23,000	82,600	34.5	288.4	73,700		240
245					17.4	248.6	20,900	79,700	31.3	280.2	71,100		245
250					9.5	225.1		76,900	27.8	270.9	68,600		250
255									23.8	259.8	66,200		255
260									19.0	246.0	63,900		260
265									12.2	226.1	61,500		265

# MLC650 VPC-MAX S-1

ASME B30.5

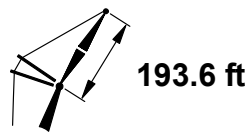
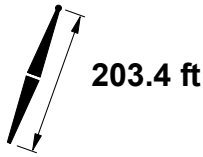

ft	85°				83°				80°				ft
	ft	lb	lb	lb	ft	lb	lb	lb	ft	lb	lb	lb	
85	73.6	397.5	294,800	326,400									85
90	72.0	395.9	274,000	325,900									90
95	70.4	394.0	255,600	325,400	72.7	395.7	241,200	323,000					95
100	68.8	392.0	239,000	324,500	71.1	393.9	225,400	323,000					100
105	67.2	389.9	224,100	323,500	69.5	392.0	211,200	314,400					105
110	65.6	387.6	210,600	306,300	67.9	389.9	198,300	297,000					110
115	63.9	385.1	198,400	290,000	66.3	387.7	186,600	281,200	69.7	390.5	169,100	268,000	115
120	62.3	382.4	187,100	275,200	64.6	385.3	175,900	266,800	68.1	388.4	159,200	254,200	120
125	60.6	379.5	176,800	261,700	63.0	382.7	166,100	253,600	66.4	386.2	150,100	241,600	125
130	58.8	376.4	167,400	249,200	61.3	379.9	157,100	241,500	64.8	383.8	141,700	229,900	130
135	57.0	373.1	158,600	237,800	59.5	376.9	148,700	230,300	63.1	381.2	134,000	219,200	135
140	55.2	369.6	150,500	227,100	57.8	373.7	141,000	220,000	61.4	378.4	126,800	209,300	140
145	53.4	365.8	142,900	217,300	56.0	370.2	133,800	210,400	59.7	375.5	120,100	200,100	145
150	51.5	361.8	135,900	208,100	54.2	366.6	127,000	201,500	58.0	372.3	113,900	191,500	150
155	49.5	357.5	129,300	199,600	52.3	362.7	120,800	193,100	56.2	368.9	108,100	183,500	155
160	47.5	352.9	123,100	191,500	50.3	358.5	114,900	185,300	54.4	365.2	102,600	176,100	160
165	45.4	347.9	117,300	184,000	48.3	354.0	109,300	178,000	52.5	361.3	97,500	169,100	165
170	43.3	342.5	111,800	177,000	46.3	349.1	104,100	171,200	50.6	357.2	92,600	162,500	170
175	41.0	336.7	106,700	170,400	44.2	343.9	99,200	164,700	48.6	352.7	88,100	156,300	175
180	38.6	330.4	101,800	164,100	41.9	338.3	94,600	158,600	46.5	347.9	83,800	150,500	180
185	36.1	323.6	97,100	158,200	39.6	332.3	90,200	152,900	44.4	342.8	79,700	144,900	185
190	33.4	316.0	92,700	152,600	37.2	325.6	86,000	147,400	42.2	337.2	75,800	139,700	190
195	30.5	307.6	88,500	147,200	34.5	318.4	82,000	142,200	39.9	331.2	72,100	134,800	195
200	27.3	298.0	84,500	142,200	31.7	310.3	78,200	137,300	37.4	324.6	68,600	130,100	200
205	23.7	286.9	80,600	137,300	28.7	301.3	74,500	132,600	34.8	317.4	65,300	125,600	205
210	19.4	273.3	76,800	132,700	25.3	290.8	71,000	128,200	32.0	309.5	62,000	121,300	210
215	13.8	255.0	73,100	128,200	21.3	278.4	67,600	123,900	29.0	300.5	58,900	117,200	215
220					16.4	262.6	64,200	119,700	25.6	290.3	55,900	113,300	220
225					8.8	237.5	60,700	115,700	21.8	278.2	53,000	109,500	225
230									17.0	262.8	50,100	105,900	230
235									9.9	239.6	47,100	102,300	235
240													240
245													245
250													250
255													255
260													260
265													265
270													270
275													275
280													280

# MLC650 VPC-MAX S-1

ASME B30.5

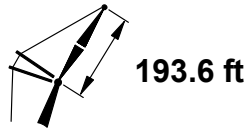
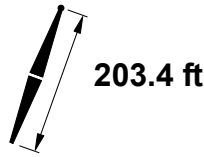

ft	75°				70°				65°			
	ft	lb	ft	lb	ft	lb	ft	lb	ft	lb	ft	
85												85
90												90
95												95
100												100
105												105
110												110
115												115
120												120
125												125
130												130
135												135
140												140
145												145
150	63.9	378.3	92,200	175,300								150
155	62.2	375.6	87,100	167,800								155
160	60.5	372.7	82,400	160,900								160
165	58.8	369.7	77,900	154,400								165
170	57.0	366.4	73,700	148,200								170
175	55.2	362.8	69,700	142,500								175
180	53.3	359.1	66,000	137,100	59.4	365.2	48,500	124,000				180
185	51.4	355.0	62,400	131,900	57.7	362.0	45,400	119,200				185
190	49.5	350.7	59,000	127,100	55.9	358.6	42,600	114,700				190
195	47.5	346.1	55,800	122,500	54.1	354.9	39,800	110,400				195
200	45.4	341.1	52,800	118,100	52.2	351.0	37,200	106,400				200
205	43.2	335.7	49,900	113,900	50.2	346.7	34,700	102,500				205
210	40.9	329.9	47,100	110,000	48.2	342.2	32,300	98,900	54.5	348.8	88,100	210
215	38.6	323.6	44,400	106,200	46.2	337.4	30,100	95,400	52.7	345.0	84,900	215
220	36.1	316.7	41,900	102,600	44.0	332.2	27,900	92,000	50.8	340.8	81,800	220
225	33.4	309.1	39,400	99,100	41.8	326.5	25,800	88,800	48.8	336.4	78,900	225
230	30.5	300.7	37,000	95,800	39.5	320.4	23,800	85,800	46.7	331.6	76,000	230
235	27.3	291.1	34,700	92,600	37.0	313.8	21,800	82,900	44.6	326.5	73,300	235
240	23.6	279.9	32,400	89,500	34.4	306.5		80,000	42.4	321.0	70,700	240
245	19.3	266.3	30,200	86,600	31.6	298.4		77,300	40.1	315.0	68,200	245
250	13.7	247.9	27,900	83,600	28.5	289.3		74,700	37.7	308.6	65,900	250
255					25.1	278.8		72,200	35.1	301.4	63,500	255
260					21.1	266.2		69,700	32.4	293.6	61,300	260
265					16.1	250.1		67,300	29.4	284.7	59,100	265
270					8.2	224.0		64,800	26.0	274.7	57,000	270
275									22.2	262.8	55,000	275
280									17.6	247.9	53,000	280

# MLC650 VPC-MAX S-1

ASME B30.5

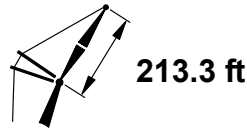
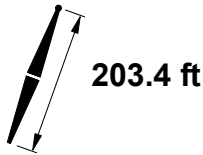

ft	85°				83°				80°				ft
	ft	lb	lb	lb	ft	lb	lb	lb	ft	lb	lb	lb	
90	73.7	416.6	270,900	278,200									90
95	72.3	415.0	252,400	278,000									95
100	70.9	413.2	235,900	277,700	72.9	414.8	222,000	274,900					100
105	69.4	411.3	221,000	277,100	71.5	413.1	207,800	274,900					105
110	68.0	409.2	207,600	276,300	70.0	411.2	195,000	274,900					110
115	66.5	407.0	195,300	275,200	68.6	409.2	183,300	274,900					115
120	65.0	404.6	184,100	272,200	67.1	407.0	172,600	263,600					120
125	63.5	402.1	173,900	258,700	65.7	404.7	162,900	250,500	68.8	407.7	146,500	238,200	125
130	62.0	399.3	164,400	246,300	64.2	402.3	153,900	238,400	67.3	405.5	138,100	226,700	130
135	60.5	396.5	155,700	234,900	62.6	399.6	145,500	227,300	65.8	403.2	130,400	216,000	135
140	58.9	393.4	147,600	224,300	61.1	396.8	137,800	217,000	64.3	400.8	123,300	206,200	140
145	57.3	390.1	140,000	214,500	59.5	393.8	130,600	207,500	62.8	398.2	116,600	197,000	145
150	55.6	386.7	133,000	205,400	57.9	390.7	124,000	198,600	61.3	395.4	110,500	188,500	150
155	54.0	383.0	126,500	196,900	56.3	387.3	117,700	190,400	59.7	392.4	104,700	180,600	155
160	52.3	379.1	120,300	189,000	54.7	383.7	111,900	182,600	58.1	389.3	99,200	173,200	160
165	50.5	374.9	114,500	181,500	53.0	379.9	106,400	175,300	56.5	385.9	94,200	166,200	165
170	48.7	370.5	109,100	174,500	51.2	375.8	101,200	168,500	54.8	382.3	89,400	159,700	170
175	46.9	365.7	104,000	167,900	49.5	371.5	96,300	162,100	53.2	378.5	84,900	153,500	175
180	45.0	360.7	99,100	161,700	47.6	366.9	91,700	156,100	51.4	374.5	80,600	147,700	180
185	43.0	355.3	94,500	155,800	45.8	362.0	87,300	150,300	49.7	370.2	76,600	142,200	185
190	40.9	349.5	90,200	150,200	43.8	356.7	83,200	144,900	47.8	365.6	72,700	137,100	190
195	38.8	343.2	86,100	144,900	41.8	351.1	79,300	139,800	46.0	360.8	69,100	132,100	195
200	36.5	336.5	82,100	139,900	39.7	345.0	75,500	134,900	44.0	355.5	65,600	127,500	200
205	34.1	329.1	78,300	135,200	37.5	338.5	71,900	130,300	42.0	350.0	62,300	123,000	205
210	31.6	321.0	74,700	130,600	35.1	331.4	68,500	125,900	39.9	343.9	59,200	118,800	210
215	28.8	311.9	71,300	126,300	32.6	323.6	65,200	121,700	37.7	337.5	56,100	114,800	215
220	25.7	301.7	68,000	122,100	30.0	315.0	62,100	117,600	35.4	330.4	53,300	110,900	220
225	22.3	289.8	64,700	118,100	27.0	305.3	59,100	113,800	32.9	322.7	50,500	107,300	225
230	18.1	275.3	61,600	114,300	23.8	294.1	56,100	110,100	30.3	314.2	47,800	103,700	230
235	12.7	255.6	58,400	110,600	20.0	280.9	53,200	106,500	27.4	304.6	45,200	100,300	235
240					15.2	263.9	50,400	103,100	24.1	293.7	42,700	97,100	240
245					7.6	236.1	47,400	99,600	20.4	280.7	40,200	93,900	245
250									15.8	264.2	37,700	90,900	250
255									8.8	238.7	35,200	87,800	255
260													260
265													265
270													270
275													275
280													280
285													285
290													290
300													300

# MLC650 VPC-MAX S-1

ASME B30.5

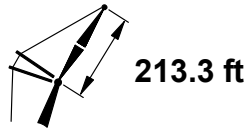
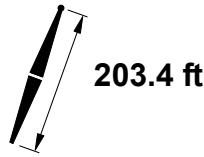

ft	75°				70°				65°				
	ft	lb	ft	lb	ft	lb	ft	lb	ft	lb	ft	lb	
90													90
95													95
100													100
105													105
110													110
115													115
120													120
125													125
130													130
135													135
140													140
145													145
150													150
155													155
160	63.5	395.3	78,500	157,600									160
165	62.0	392.6	74,100	151,200									165
170	60.4	389.7	69,900	145,100									170
175	58.9	386.6	66,000	139,400									175
180	57.2	383.4	62,300	134,000									180
185	55.6	379.9	58,800	128,900									185
190	53.9	376.2	55,500	124,100	59.4	382.2	38,600	111,500					190
195	52.2	372.3	52,300	119,600	57.9	379.0	35,900	107,300					195
200	50.5	368.1	49,300	115,200	56.2	375.6	33,300	103,200					200
205	48.7	363.7	46,400	111,100	54.6	372.0	30,900	99,400					205
210	46.8	358.9	43,700	107,200	52.9	368.2	28,500	95,800					210
215	44.9	353.9	41,100	103,500	51.2	364.1	26,300	92,400					215
220	43.0	348.5	38,600	99,900	49.4	359.8	24,200	89,100					220
225	40.9	342.7	36,200	96,500	47.5	355.1	22,100	85,900	53.3	362.1	75,700		225
230	38.7	336.4	33,900	93,200	45.7	350.2	20,200	82,900	51.6	358.1	72,900		230
235	36.5	329.6	31,700	90,100	43.7	344.9		80,000	49.9	353.9	70,200		235
240	34.1	322.2	29,500	87,100	41.7	339.3		77,200	48.0	349.3	67,700		240
245	31.5	314.1	27,500	84,200	39.6	333.2		74,600	46.2	344.5	65,200		245
250	28.7	305.1	25,400	81,400	37.3	326.6		72,000	44.2	339.3	62,900		250
255	25.7	294.8	23,500	78,700	35.0	319.5		69,600	42.2	333.8	60,600		255
260	22.2	282.9	21,500	76,100	32.5	311.7		67,200	40.1	327.8	58,500		260
265	18.1	268.3		73,600	29.8	303.0		64,900	38.0	321.4	56,300		265
270	12.6	248.5		71,100	26.9	293.2		62,700	35.6	314.4	54,300		270
275					23.6	282.0		60,500	33.2	306.7	52,300		275
280					19.7	268.6		58,400	30.6	298.3	50,400		280
290					6.9	222.1		54,100	24.5	278.1	46,800		290
300									16.3	249.4	43,300		300

# MLC650 VPC-MAX S-1

ASME B30.5

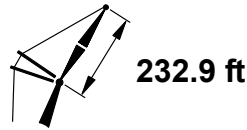
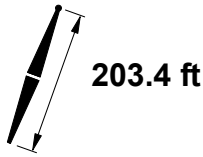

ft	85°				83°				80°				ft
	ft	lb	lb	lb	ft	lb	lb	lb	ft	lb	lb	lb	
95	73.9	435.7	246,900	253,000									95
100	72.6	434.0	230,400	252,700									100
105	71.3	432.3	215,600	252,300									105
110	70.0	430.4	202,200	251,700	71.8	432.2	189,100	249,900					110
115	68.6	428.4	190,000	251,000	70.5	430.4	177,500	249,900					115
120	67.3	426.3	178,800	250,100	69.2	428.4	166,900	249,900					120
125	65.9	424.0	168,600	249,000	67.8	426.3	157,200	245,600					125
130	64.6	421.6	159,200	241,800	66.5	424.1	148,300	233,700	69.3	426.9	132,000	221,500	130
135	63.2	419.0	150,500	230,500	65.1	421.8	140,000	222,600	68.0	424.8	124,300	211,000	135
140	61.8	416.3	142,400	220,000	63.8	419.3	132,300	212,400	66.6	422.6	117,300	201,200	140
145	60.4	413.4	134,900	210,200	62.4	416.6	125,200	203,000	65.3	420.3	110,700	192,100	145
150	58.9	410.4	127,900	201,200	61.0	413.8	118,500	194,200	63.9	417.8	104,600	183,700	150
155	57.5	407.1	121,400	192,700	59.5	410.8	112,300	185,900	62.5	415.1	98,800	175,800	155
160	56.0	403.7	115,300	184,800	58.1	407.6	106,500	178,200	61.1	412.3	93,500	168,500	160
165	54.5	400.1	109,600	177,400	56.6	404.3	101,100	171,000	59.7	409.4	88,400	161,600	165
170	52.9	396.3	104,200	170,400	55.1	400.7	95,900	164,300	58.2	406.2	83,700	155,100	170
175	51.3	392.2	99,100	163,900	53.6	397.0	91,100	157,900	56.8	402.9	79,200	149,000	175
180	49.7	387.9	94,300	157,700	52.0	393.1	86,500	151,900	55.3	399.4	75,000	143,300	180
185	48.0	383.4	89,700	151,800	50.4	388.9	82,200	146,200	53.7	395.7	71,000	137,800	185
190	46.3	378.6	85,400	146,300	48.7	384.4	78,100	140,800	52.2	391.8	67,300	132,700	190
195	44.6	373.5	81,300	141,100	47.1	379.8	74,200	135,800	50.6	387.6	63,700	127,800	195
200	42.8	368.0	77,400	136,100	45.3	374.8	70,500	130,900	48.9	383.2	60,300	123,200	200
205	40.9	362.2	73,700	131,400	43.5	369.5	67,000	126,300	47.2	378.5	57,000	118,800	205
210	38.9	356.0	70,200	126,900	41.7	363.8	63,700	122,000	45.5	373.6	53,900	114,600	210
215	36.9	349.3	66,800	122,600	39.7	357.8	60,400	117,800	43.7	368.3	50,900	110,700	215
220	34.7	342.1	63,600	118,500	37.7	351.3	57,400	113,800	41.9	362.7	48,100	106,800	220
225	32.4	334.2	60,500	114,600	35.6	344.3	54,400	110,000	40.0	356.7	45,400	103,200	225
230	30.0	325.6	57,500	110,800	33.4	336.7	51,600	106,400	37.9	350.3	42,800	99,700	230
235	27.3	316.0	54,600	107,200	31.0	328.4	48,900	102,900	35.8	343.3	40,300	96,400	235
240	24.4	305.2	51,800	103,800	28.4	319.3	46,200	99,500	33.6	335.8	37,900	93,200	240
245	21.0	292.5	49,100	100,400	25.6	309.0	43,700	96,300	31.3	327.6	35,500	90,100	245
250	17.0	277.1	46,400	97,200	22.5	297.2	41,200	93,200	28.7	318.6	33,300	87,200	250
255	11.7	255.8	43,700	94,000	18.8	283.1	38,700	90,200	25.9	308.4	31,100	84,300	255
260					14.1	264.9	36,300	87,200	22.8	296.8	28,900	81,600	260
265					6.5	234.0	33,700	84,300	19.2	283.0	26,800	78,900	265
270									14.7	265.4	24,700	76,300	270
275									7.7	237.4	22,500	73,600	275
280													280
290													290
300													300
310													310
320													320



# MLC650 VPC-MAX S-1

ASME B30.5

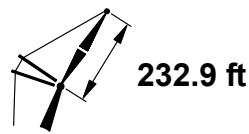
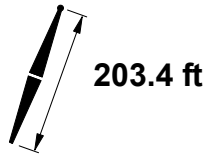

ft	75°				70°			65°			ft
	ft	ft	lb	lb	ft	lb	ft	lb	ft		
95											95
100											100
105											105
110											110
115											115
120											120
125											125
130											130
135											135
140											140
145											145
150											150
155											155
160											160
165	64.6	414.8	67,600	146,100							165
170	63.2	412.3	63,500	140,100							170
175	61.8	409.5	59,700	134,400							175
180	60.3	406.6	56,000	129,100							180
185	58.9	403.6	52,600	124,100							185
190	57.4	400.3	49,300	119,300							190
195	55.9	396.9	46,200	114,800							195
200	54.4	393.3	43,300	110,500	59.5	399.1	98,100				200
205	52.9	389.5	40,500	106,500	58.0	396.0	94,400				205
210	51.3	385.4	37,800	102,600	56.5	392.6	90,800				210
215	49.7	381.1	35,300	98,900	55.0	389.1	87,400				215
220	48.0	376.6	32,800	95,400	53.5	385.3	84,200				220
225	46.3	371.8	30,500	92,000	51.9	381.4	81,100				225
230	44.6	366.7	28,200	88,800	50.3	377.2	78,100				230
235	42.7	361.2	26,100	85,700	48.7	372.7	75,300	53.9	379.3	65,100	235
240	40.8	355.4	24,000	82,800	47.0	368.0	72,500	52.3	375.4	62,600	240
245	38.9	349.2	22,000	79,900	45.2	363.0	69,900	50.7	371.2	60,200	245
250	36.8	342.5	20,100	77,200	43.4	357.7	67,400	49.1	366.9	57,900	250
255	34.7	335.2		74,600	41.6	352.0	65,000	47.4	362.2	55,700	255
260	32.4	327.4		72,000	39.6	346.0	62,700	45.7	357.3	53,600	260
265	29.9	318.7		69,600	37.6	339.5	60,400	43.9	352.1	51,500	265
270	27.3	309.1		67,200	35.5	332.4	58,300	42.1	346.5	49,600	270
275	24.3	298.3		64,900	33.3	324.8	56,200	40.2	340.5	47,700	275
280	21.0	285.6		62,700	30.9	316.5	54,200	38.2	334.2	45,800	280
290	11.5	248.7		58,400	25.5	296.9	50,300	33.9	319.8	42,300	290
300					18.6	270.8	46,600	29.0	302.8	39,000	300
310					5.7	219.5	42,900	23.2	281.3	35,800	310
320								15.3	250.7	32,700	320

# MLC650 VPC-MAX S-1

ASME B30.5

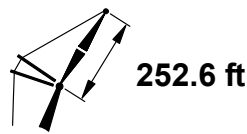
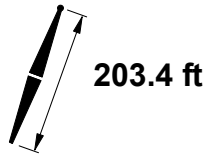

ft	85°				83°				80°				ft
	ft	lb	lb	lb	ft	lb	lb	lb	ft	lb	lb	lb	
100	74.0	454.7	218,500	218,500									100
105	72.8	453.1	212,200	218,100									105
110	71.6	451.4	198,800	217,600									110
115	70.4	449.6	186,700	217,000	72.1	451.3	174,000	215,200					115
120	69.2	447.6	175,500	216,300	70.9	449.5	163,400	215,200					120
125	67.9	445.6	165,300	215,500	69.7	447.6	153,700	215,200					125
130	66.7	443.4	155,900	214,600	68.4	445.6	144,800	215,000					130
135	65.4	441.1	147,300	213,600	67.2	443.5	136,500	214,700	69.8	446.1	120,600	207,300	135
140	64.2	438.6	139,200	212,600	66.0	441.2	128,900	209,300	68.6	444.1	113,500	197,900	140
145	62.9	436.0	131,700	207,300	64.7	438.8	121,800	199,900	67.3	441.9	107,000	188,900	145
150	61.6	433.3	124,800	198,300	63.4	436.2	115,200	191,200	66.1	439.7	100,900	180,500	150
155	60.3	430.4	118,300	189,900	62.1	433.6	109,000	183,000	64.8	437.3	95,200	172,700	155
160	59.0	427.3	112,200	182,000	60.8	430.7	103,200	175,400	63.6	434.8	89,900	165,400	160
165	57.6	424.1	106,500	174,600	59.5	427.7	97,800	168,200	62.3	432.1	84,900	158,600	165
170	56.3	420.7	101,100	167,700	58.2	424.6	92,700	161,500	61.0	429.3	80,200	152,100	170
175	54.9	417.2	96,000	161,200	56.8	421.3	87,900	155,100	59.7	426.3	75,700	146,100	175
180	53.4	413.4	91,300	155,000	55.4	417.8	83,300	149,100	58.3	423.2	71,500	140,400	180
185	52.0	409.5	86,700	149,200	54.0	414.1	79,000	143,500	57.0	419.9	67,600	135,000	185
190	50.5	405.3	82,400	143,700	52.6	410.3	75,000	138,200	55.6	416.4	63,800	129,900	190
195	49.0	400.9	78,400	138,500	51.1	406.2	71,100	133,100	54.2	412.8	60,300	125,000	195
200	47.5	396.3	74,500	133,600	49.6	401.9	67,400	128,300	52.8	409.0	56,900	120,400	200
205	45.9	391.4	70,800	128,900	48.1	397.4	64,000	123,700	51.3	404.9	53,700	116,100	205
210	44.3	386.3	67,300	124,400	46.6	392.6	60,600	119,400	49.8	400.6	50,600	111,900	210
215	42.6	380.8	64,000	120,200	44.9	387.6	57,400	115,300	48.3	396.1	47,700	108,000	215
220	40.8	375.0	60,800	116,100	43.3	382.2	54,400	111,300	46.7	391.4	44,900	104,200	220
225	39.0	368.8	57,700	112,200	41.6	376.6	51,500	107,500	45.1	386.4	42,200	100,600	225
230	37.2	362.2	54,800	108,500	39.8	370.5	48,700	103,900	43.5	381.1	39,600	97,100	230
235	35.2	355.1	52,000	104,900	37.9	364.1	46,000	100,500	41.8	375.4	37,200	93,800	235
240	33.1	347.4	49,200	101,500	36.0	357.2	43,500	97,200	40.0	369.5	34,800	90,700	240
245	30.9	339.1	46,600	98,200	34.0	349.8	41,000	94,000	38.1	363.1	32,500	87,600	245
250	28.5	330.0	44,100	95,100	31.8	341.8	38,600	90,900	36.2	356.2	30,300	84,700	250
255	26.0	319.8	41,600	92,000	29.5	333.0	36,300	88,000	34.2	348.9	28,200	81,900	255
260	23.1	308.4	39,300	89,100	27.1	323.3	34,000	85,100	32.1	340.9	26,200	79,200	260
265	19.9	295.0	36,900	86,300	24.4	312.4	31,800	82,400	29.8	332.2	24,200	76,600	265
270	16.0	278.6	34,600	83,500	21.3	300.0	29,700	79,700	27.4	322.6	22,300	74,100	270
275	10.7	255.8	32,200	80,800	17.7	285.0	27,600	77,200	24.7	311.9	20,400	71,600	275
280					13.2	265.6	25,500	74,600	21.7	299.6		69,300	280
290									13.8	266.3		64,700	290
300													300
310													310
320													320
330													330
340													340

# MLC650 VPC-MAX S-1

ASME B30.5

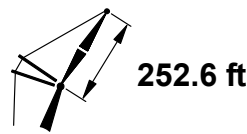
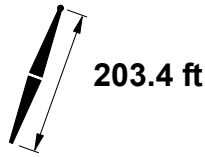

ft	75°				70°			65°			ft
	°	ft	lb	lb	°	ft	lb	°	ft	lb	
100											100
105											105
110											110
115											115
120											120
125											125
130											130
135											135
140											140
145											145
150											150
155											155
160											160
165											165
170											170
175	64.2	431.8	55,700	131,200							175
180	62.9	429.2	52,100	125,900							180
185	61.6	426.5	48,700	120,900							185
190	60.3	423.6	45,500	116,200							190
195	58.9	420.5	42,400	111,700							195
200	57.6	417.3	39,500	107,500							200
205	56.2	413.9	36,800	103,500							205
210	54.8	410.4	34,100	99,600	59.5	416.1	87,600				210
215	53.4	406.6	31,600	96,000	58.1	412.9	84,300				215
220	52.0	402.7	29,200	92,500	56.8	409.6	81,000				220
225	50.5	398.5	26,900	89,100	55.4	406.1	78,000				225
230	49.0	394.1	24,700	86,000	54.0	402.4	75,000				230
235	47.4	389.5	22,600	82,900	52.5	398.6	72,200				235
240	45.9	384.6	20,500	80,000	51.1	394.5	69,500				240
245	44.2	379.4		77,200	49.6	390.2	67,000	54.3	396.4	57,100	245
250	42.5	374.0		74,500	48.0	385.7	64,500	52.9	392.6	54,800	250
255	40.8	368.1		71,900	46.5	380.9	62,100	51.5	388.5	52,600	255
260	39.0	361.9		69,400	44.9	375.8	59,800	50.0	384.3	50,500	260
265	37.1	355.3		67,000	43.2	370.5	57,600	48.4	379.8	48,500	265
270	35.2	348.2		64,700	41.5	364.8	55,500	46.9	375.1	46,500	270
275	33.1	340.5		62,400	39.7	358.7	53,400	45.3	370.1	44,700	275
280	30.9	332.2		60,300	37.8	352.3	51,400	43.6	364.8	42,900	280
290	25.9	312.9		56,200	33.9	337.9	47,700	40.2	353.3	39,400	290
300	19.9	288.0		52,200	29.4	321.0	44,100	36.4	340.2	36,200	300
310	10.6	248.6		48,400	24.2	300.3	40,800	32.3	325.0	33,100	310
320					17.5	272.7	37,500	27.6	306.9	30,200	320
330					4.4	215.6	34,200	22.0	284.2	27,500	330
340								14.3	251.8	24,800	340

# MLC650 VPC-MAX S-1

ASME B30.5

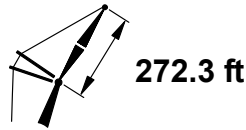
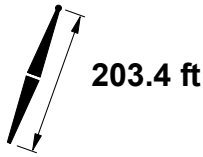

ft	85°				83°				80°				ft
	ft	lb	lb	lb	ft	lb	lb	lb	ft	lb	lb	lb	
105	74.1	473.8	188,500	188,500									105
110	73.0	472.2	187,700	187,700									110
115	71.9	470.5	184,500	187,200									115
120	70.7	468.7	173,400	187,000	72.3	470.4	161,000	185,400					120
125	69.6	466.8	163,200	186,000	71.2	468.6	151,400	185,300					125
130	68.5	464.8	153,800	185,300	70.1	466.8	142,500	185,100					130
135	67.3	462.7	145,200	184,500	69.0	464.8	134,300	185,100					135
140	66.2	460.5	137,200	183,700	67.8	462.7	126,700	184,600					140
145	65.0	458.1	129,700	182,800	66.7	460.5	119,600	184,100	69.1	463.3	104,500	179,200	145
150	63.8	455.6	122,800	181,900	65.5	458.2	113,000	183,700	67.9	461.2	98,400	178,300	150
155	62.7	453.0	116,300	180,900	64.3	455.8	106,900	181,000	66.8	459.0	92,800	170,500	155
160	61.5	450.2	110,300	179,900	63.1	453.2	101,100	173,400	65.6	456.7	87,500	163,200	160
165	60.2	447.3	104,600	172,800	62.0	450.5	95,700	166,200	64.5	454.3	82,500	156,400	165
170	59.0	444.3	99,200	165,900	60.7	447.7	90,600	159,600	63.3	451.8	77,800	150,100	170
175	57.8	441.1	94,200	159,400	59.5	444.7	85,800	153,300	62.1	449.1	73,400	144,000	175
180	56.5	437.7	89,400	153,300	58.3	441.6	81,300	147,300	60.9	446.2	69,300	138,400	180
185	55.2	434.2	84,900	147,500	57.0	438.3	77,100	141,700	59.7	443.3	65,400	133,000	185
190	53.9	430.5	80,700	142,100	55.7	434.8	73,000	136,400	58.4	440.2	61,600	127,900	190
195	52.6	426.7	76,600	136,900	54.4	431.2	69,200	131,400	57.2	436.9	58,100	123,100	195
200	51.2	422.6	72,800	132,000	53.1	427.4	65,500	126,600	55.9	433.5	54,800	118,600	200
205	49.8	418.4	69,100	127,300	51.8	423.5	62,100	122,100	54.6	429.9	51,600	114,300	205
210	48.4	413.9	65,600	122,900	50.4	419.3	58,800	117,800	53.3	426.1	48,500	110,100	210
215	47.0	409.2	62,300	118,600	49.0	414.9	55,600	113,700	51.9	422.2	45,600	106,200	215
220	45.5	404.2	59,200	114,600	47.6	410.3	52,600	109,700	50.6	418.0	42,900	102,500	220
225	44.0	399.0	56,100	110,700	46.1	405.5	49,700	106,000	49.2	413.7	40,200	98,900	225
230	42.4	393.5	53,200	107,100	44.6	400.4	47,000	102,400	47.7	409.1	37,700	95,500	230
235	40.8	387.7	50,400	103,500	43.1	395.0	44,300	99,000	46.3	404.3	35,300	92,200	235
240	39.1	381.5	47,800	100,100	41.5	389.3	41,800	95,700	44.8	399.2	32,900	89,100	240
245	37.4	375.0	45,200	96,900	39.8	383.3	39,400	92,500	43.2	393.8	30,700	86,000	245
250	35.6	368.0	42,700	93,800	38.1	376.9	37,000	89,500	41.7	388.2	28,500	83,200	250
255	33.7	360.5	40,300	90,800	36.3	370.1	34,800	86,600	40.0	382.2	26,500	80,400	255
260	31.7	352.4	38,000	87,900	34.5	362.8	32,600	83,800	38.3	375.9	24,400	77,700	260
265	29.6	343.7	35,800	85,100	32.5	355.0	30,500	81,100	36.5	369.1	22,500	75,100	265
270	27.3	334.0	33,600	82,400	30.5	346.5	28,400	78,500	34.7	361.9	20,600	72,600	270
275	24.8	323.4	31,500	79,800	28.3	337.3	26,400	76,000	32.8	354.1		70,300	275
280	22.1	311.3	29,400	77,300	25.9	327.1	24,500	73,500	30.7	345.7		67,900	280
290	15.1	279.9	25,400	72,500	20.3	302.5	20,800	68,900	26.1	326.5		63,500	290
300					12.3	266.2		64,500	20.6	302.3		59,400	300
310									12.9	267.0		55,400	310
320													320
330													330
340													340
350													350

# MLC650 VPC-MAX S-1

ASME B30.5

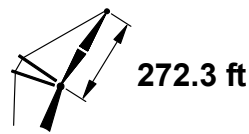
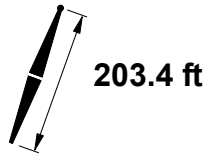

ft	75°				70°			65°			ft
	°	ft	lb	lb	°	ft	lb	°	ft	lb	
105											105
110											110
115											115
120											120
125											125
130											130
135											135
140											140
145											145
150											150
155											155
160											160
165											165
170											170
175											175
180	65.0	451.3	49,500	123,700							180
185	63.8	448.8	46,100	118,700							185
190	62.6	446.2	42,900	114,000							190
195	61.4	443.4	39,900	109,600							195
200	60.2	440.5	37,000	105,400							200
205	59.0	437.5	34,300	101,400							205
210	57.7	434.3	31,700	97,600							210
215	56.5	431.0	29,200	94,000							215
220	55.2	427.4	26,800	90,500	59.5	433.1	78,900				220
225	53.9	423.8	24,600	87,200	58.2	429.9	75,800				225
230	52.6	419.9	22,400	84,100	57.0	426.6	72,900				230
235	51.2	415.8	20,300	81,000	55.7	423.2	70,200				235
240	49.8	411.6		78,200	54.4	419.5	67,500				240
245	48.4	407.1		75,400	53.1	415.8	65,000				245
250	47.0	402.4		72,700	51.7	411.8	62,500				250
255	45.5	397.4		70,100	50.3	407.6	60,200	54.7	413.5	50,500	255
260	44.0	392.2		67,700	48.9	403.2	57,900	53.4	409.7	48,400	260
265	42.4	386.7		65,300	47.5	398.6	55,700	52.1	405.8	46,400	265
270	40.8	380.9		63,000	46.0	393.7	53,600	50.7	401.7	44,500	270
275	39.1	374.7		60,800	44.5	388.6	51,600	49.3	397.3	42,600	275
280	37.4	368.2		58,700	43.0	383.2	49,600	47.9	392.8	40,900	280
290	33.7	353.6		54,600	39.7	371.5	45,900	44.9	382.9	37,500	290
300	29.5	336.8		50,800	36.3	358.2	42,400	41.8	372.0	34,300	300
310	24.8	316.5		47,300	32.4	343.1	39,200	38.5	359.7	31,300	310
320	18.9	290.3		43,800	28.1	325.3	36,100	34.9	345.9	28,500	320
330	9.8	248.2		40,500	23.1	303.5	33,200	30.9	329.8	25,900	330
340					16.6	274.3	30,300	26.4	310.8	23,300	340
350					2.6	208.8	27,300	21.0	286.9	20,900	350

# MLC650 VPC-MAX S-1

ASME B30.5

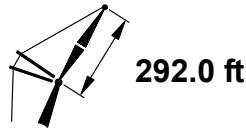
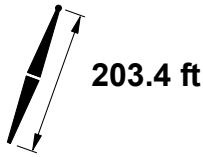

ft	85°				83°				80°				ft
	ft	lb	lb	lb	ft	lb	lb	lb	ft	lb	lb	lb	
110	74.2	492.8	177,000	177,000									110
115	73.1	491.3	176,500	176,500									115
120	72.1	489.6	165,500	175,900									120
125	71.1	487.9	155,400	175,300	72.5	489.4	143,000	174,200					125
130	70.0	486.0	146,000	174,600	71.5	487.7	134,200	174,000					130
135	69.0	484.0	137,400	173,900	70.4	485.9	126,000	173,700					135
140	67.9	482.0	129,400	173,000	69.4	484.0	118,500	173,400					140
145	66.8	479.8	122,000	172,200	68.3	482.0	111,400	173,000					145
150	65.7	477.5	115,100	171,300	67.3	479.9	104,900	172,500	69.5	482.5	89,700	167,800	150
155	64.7	475.1	108,700	170,400	66.2	477.6	98,800	172,000	68.4	480.5	84,100	163,700	155
160	63.6	472.6	102,700	169,400	65.1	475.3	93,100	167,100	67.4	478.3	78,900	156,600	160
165	62.4	469.9	97,000	166,900	64.0	472.8	87,700	160,000	66.3	476.1	74,000	149,800	165
170	61.3	467.2	91,700	160,000	62.9	470.2	82,700	153,400	65.2	473.8	69,300	143,500	170
175	60.2	464.3	86,700	153,600	61.8	467.5	78,000	147,100	64.1	471.3	65,000	137,500	175
180	59.0	461.2	81,900	147,500	60.7	464.6	73,500	141,200	63.0	468.7	60,900	131,900	180
185	57.9	458.1	77,500	141,700	59.5	461.7	69,200	135,700	61.9	466.0	57,000	126,600	185
190	56.7	454.7	73,200	136,300	58.4	458.5	65,200	130,400	60.8	463.2	53,300	121,600	190
195	55.5	451.3	69,200	131,200	57.2	455.3	61,400	125,400	59.6	460.2	49,900	116,800	195
200	54.3	447.6	65,400	126,300	56.0	451.9	57,800	120,700	58.5	457.1	46,600	112,300	200
205	53.1	443.8	61,800	121,600	54.8	448.3	54,400	116,200	57.3	453.9	43,400	108,000	205
210	51.8	439.9	58,300	117,200	53.6	444.6	51,100	111,900	56.1	450.5	40,400	103,900	210
215	50.5	435.7	55,000	113,000	52.3	440.7	48,000	107,800	54.9	447.0	37,600	100,000	215
220	49.2	431.4	51,900	109,000	51.1	436.6	45,000	103,900	53.7	443.2	34,800	96,300	220
225	47.9	426.8	48,900	105,100	49.8	432.3	42,200	100,200	52.5	439.4	32,200	92,800	225
230	46.6	422.1	46,000	101,500	48.5	427.9	39,500	96,600	51.2	435.3	29,700	89,400	230
235	45.2	417.1	43,200	98,000	47.1	423.2	36,800	93,200	49.9	431.1	27,300	86,100	235
240	43.7	411.8	40,600	94,600	45.7	418.3	34,300	90,000	48.6	426.6	25,000	83,000	240
245	42.3	406.3	38,000	91,400	44.3	413.2	31,900	86,800	47.3	422.0	22,800	80,100	245
250	40.8	400.5	35,600	88,300	42.9	407.7	29,600	83,800	45.9	417.1	20,700	77,200	250
255	39.2	394.3	33,200	85,300	41.4	402.0	27,400	80,900	44.5	412.0		74,400	255
260	37.6	387.8	31,000	82,400	39.9	396.0	25,200	78,200	43.0	406.6		71,800	260
265	35.9	380.9	28,800	79,700	38.3	389.7	23,200	75,500	41.6	400.9		69,300	265
270	34.2	373.5	26,700	77,000	36.6	382.9	21,200	72,900	40.0	395.0		66,800	270
275	32.4	365.7	24,600	74,500	34.9	375.8		70,400	38.5	388.6		64,400	275
280	30.4	357.2	22,600	72,000	33.1	368.1		68,000	36.8	381.9		62,200	280
290	26.2	337.9		67,300	29.2	351.0		63,500	33.3	367.2		57,800	290
300	21.1	314.1		62,800	24.8	330.6		59,200	29.5	350.3		53,700	300
310	14.3	281.0		58,600	19.4	304.9		55,200	25.0	330.1		49,900	310
320					11.6	266.4		51,300	19.7	304.7		46,300	320
330									12.1	267.5		42,800	330
340													340
350													350

# MLC650 VPC-MAX S-1

ASME B30.5

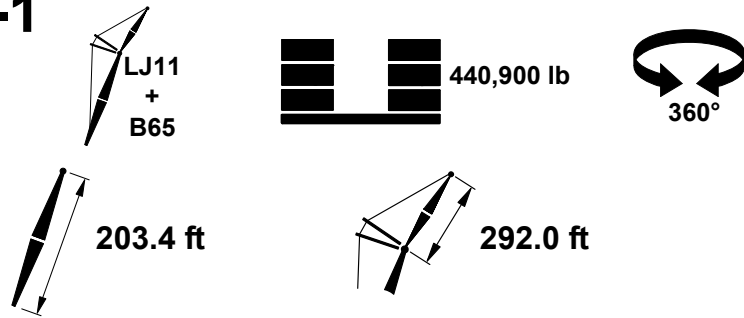

ft	75°			70°			65°			ft
	ft	lb	ft	ft	lb	ft	ft	lb	ft	
110										110
115										115
120										120
125										125
130										130
135										135
140										140
145										145
150										150
155										155
160										160
165										165
170										170
175										175
180										180
185										185
190	64.6	468.3	107,100							190
195	63.5	465.8	102,700							195
200	62.4	463.2	98,500							200
205	61.3	460.4	94,600							205
210	60.2	457.5	90,800							210
215	59.0	454.5	87,300							215
220	57.9	451.3	83,900							220
225	56.7	448.0	80,600							225
230	55.5	444.5	77,500	59.5	450.0	65,900				230
235	54.3	440.9	74,500	58.3	446.9	63,100				235
240	53.0	437.1	71,600	57.1	443.6	60,500				240
245	51.8	433.1	68,900	55.9	440.2	58,000				245
250	50.5	428.9	66,300	54.7	436.6	55,600				250
255	49.2	424.6	63,700	53.5	432.9	53,300				255
260	47.9	420.0	61,300	52.3	429.0	51,100				260
265	46.5	415.3	59,000	51.0	424.9	48,900				265
270	45.1	410.3	56,700	49.7	420.6	46,900	53.8	426.8	37,400	270
275	43.7	405.0	54,600	48.4	416.2	44,900	52.6	423.0	35,600	275
280	42.3	399.5	52,500	47.0	411.5	43,000	51.3	418.9	33,800	280
290	39.2	387.5	48,500	44.3	401.4	39,400	48.7	410.3	30,500	290
300	35.9	374.1	44,800	41.3	390.3	36,000	46.0	400.8	27,400	300
310	32.3	358.8	41,300	38.2	377.9	32,800	43.2	390.4	24,500	310
320	28.3	341.1	38,000	34.8	363.9	29,800	40.2	378.8	21,800	320
330	23.7	319.8	34,800	31.1	348.0	26,900				330
340	18.0	292.3	31,800	27.0	329.3	24,200				340
350	9.0	247.6	28,900	22.1	306.5	21,600				350

# MLC650 VPC-MAX S-1

ASME B30.5

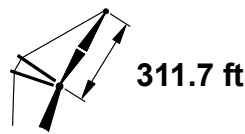
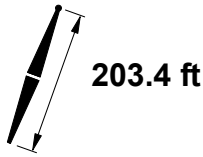

ft	85°				83°				80°				ft
	ft	lb	lb	lb	ft	lb	lb	lb	ft	lb	lb	lb	
115	74.2	511.9	154,200	154,200									115
120	73.3	510.3	153,700	153,700									120
125	72.3	508.7	153,100	153,100									125
130	71.3	507.0	144,200	152,500	72.7	508.5	132,100	151,300					130
135	70.3	505.2	135,600	151,800	71.7	506.8	124,000	150,900					135
140	69.4	503.2	127,600	151,000	70.8	505.1	116,400	150,700					140
145	68.4	501.2	120,200	150,200	69.8	503.2	109,400	150,200					145
150	67.4	499.1	113,300	149,300	68.8	501.2	102,900	149,700					150
155	66.4	496.9	106,900	148,500	67.8	499.1	96,800	149,300	69.9	501.6	81,900	145,200	155
160	65.4	494.6	100,900	147,700	66.8	497.0	91,200	148,700	68.9	499.7	76,700	145,100	160
165	64.3	492.1	95,200	146,700	65.8	494.7	85,800	148,200	67.9	497.6	71,800	145,100	165
170	63.3	489.6	89,900	145,900	64.8	492.3	80,800	147,600	66.9	495.5	67,200	141,600	170
175	62.3	486.9	84,900	144,900	63.7	489.8	76,100	145,400	65.9	493.2	62,900	135,600	175
180	61.2	484.1	80,200	144,000	62.7	487.2	71,600	139,500	64.9	490.8	58,800	130,000	180
185	60.1	481.2	75,800	140,200	61.6	484.4	67,400	134,000	63.8	488.3	54,900	124,800	185
190	59.1	478.2	71,500	134,800	60.6	481.6	63,400	128,700	62.8	485.7	51,300	119,800	190
195	58.0	475.0	67,500	129,600	59.5	478.6	59,600	123,800	61.8	483.0	47,800	115,000	195
200	56.9	471.7	63,700	124,800	58.4	475.5	56,000	119,100	60.7	480.2	44,500	110,500	200
205	55.8	468.3	60,100	120,100	57.3	472.3	52,600	114,600	59.6	477.2	41,400	106,300	205
210	54.6	464.7	56,700	115,700	56.2	468.9	49,300	110,300	58.5	474.1	38,400	102,200	210
215	53.5	461.0	53,400	111,600	55.1	465.4	46,200	106,300	57.5	470.9	35,600	98,400	215
220	52.3	457.1	50,300	107,600	54.0	461.7	43,300	102,400	56.3	467.5	32,900	94,700	220
225	51.1	453.0	47,300	103,700	52.8	457.9	40,400	98,700	55.2	464.0	30,300	91,100	225
230	49.9	448.8	44,400	100,100	51.6	453.9	37,700	95,100	54.1	460.4	27,800	87,800	230
235	48.7	444.4	41,700	96,600	50.4	449.7	35,100	91,800	52.9	456.5	25,400	84,500	235
240	47.5	439.7	39,000	93,200	49.2	445.4	32,700	88,500	51.8	452.6	23,200	81,500	240
245	46.2	434.9	36,500	90,000	48.0	440.8	30,300	85,400	50.6	448.4	21,000	78,500	245
250	44.9	429.9	34,100	86,900	46.7	436.1	28,000	82,400	49.3	444.1		75,700	250
255	43.5	424.6	31,700	84,000	45.4	431.1	25,800	79,500	48.1	439.6		72,900	255
260	42.2	419.0	29,500	81,100	44.1	425.9	23,600	76,800	46.8	434.9		70,300	260
265	40.7	413.2	27,300	78,400	42.7	420.5	21,600	74,100	45.6	429.9		67,800	265
270	39.3	407.1	25,200	75,800	41.3	414.8		71,600	44.2	424.8		65,300	270
275	37.8	400.6	23,200	73,200	39.9	408.8		69,100	42.9	419.4		63,000	275
280	36.2	393.8	21,300	70,800	38.4	402.5		66,700	41.5	413.7		60,700	280
290	32.9	378.8		66,100	35.3	388.7		62,200	38.6	401.4		56,400	290
300	29.3	361.7		61,700	31.9	373.2		58,000	35.5	387.8		52,400	300
310	25.1	341.5		57,600	28.1	355.3		54,000	32.1	372.3		48,600	310
320	20.2	316.6		53,700	23.8	334.0		50,300	28.3	354.6		45,100	320
330	13.6	281.9		50,000	18.5	307.0		46,700	24.1	333.5		41,700	330
340					10.8	266.5		43,300	18.8	306.9		38,500	340
350									11.4	267.7		35,400	350
360													360
370													370



# MLC650 VPC-MAX S-1

ASME B30.5

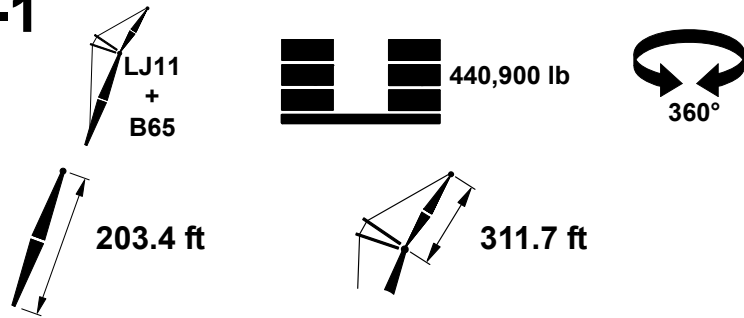

ft	75°			70°			65°			ft
	°	ft	lb	°	ft	lb	°	ft	lb	
115										115
120										120
125										125
130										130
135										135
140										140
145										145
150										150
155										155
160										160
165										165
170										170
175										175
180										180
185										185
190										190
195										195
200	64.3	485.4	96,600							200
205	63.3	482.8	92,600							205
210	62.2	480.1	88,900							210
215	61.2	477.4	85,400							215
220	60.1	474.5	82,000							220
225	59.0	471.4	78,800							225
230	58.0	468.3	75,700							230
235	56.9	465.0	72,700							235
240	55.7	461.5	69,900	59.5	467.0	58,600				240
245	54.6	457.9	67,200	58.4	463.8	56,100				245
250	53.5	454.2	64,500	57.3	460.6	53,700				250
255	52.3	450.3	62,000	56.2	457.2	51,400				255
260	51.1	446.2	59,600	55.0	453.7	49,200				260
265	49.9	442.0	57,300	53.9	450.0	47,100				265
270	48.7	437.6	55,100	52.7	446.2	45,100				270
275	47.4	432.9	52,900	51.6	442.2	43,100				275
280	46.2	428.1	50,800	50.4	438.0	41,200	54.2	443.9	31,900	280
290	43.5	417.8	46,900	47.9	429.1	37,600	51.9	436.2	28,600	290
300	40.7	406.4	43,200	45.3	419.4	34,200	49.5	427.8	25,500	300
310	37.8	393.8	39,800	42.7	408.7	31,100	47.0	418.6	22,700	310
320	34.6	379.7	36,500	39.8	397.0	28,100	44.4	408.5	20,000	320
330	31.1	363.7	33,500	36.8	383.9	25,300				330
340	27.3	345.2	30,600	33.5	369.3	22,700				340
350	22.8	322.9	27,800	30.0	352.6	20,200				350
360	17.2	294.1	25,100							360
370	8.2	246.6	22,500							370

# MLC650 VPC-MAX S-1

ASME B30.5

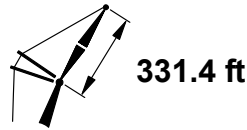
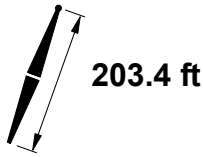

ft	85°				83°				80°				ft
	ft	lb	lb	lb	ft	lb	lb	lb	ft	lb	lb	lb	
120	74.3	530.9	133,200	133,200									120
125	73.4	529.4	132,600	132,600									125
130	72.5	527.8	132,000	132,000									130
135	71.6	526.1	131,300	131,300	72.9	527.6	120,400	130,400					135
140	70.6	524.3	124,300	130,600	71.9	525.9	112,900	130,000					140
145	69.7	522.4	116,900	129,900	71.0	524.2	105,900	129,600					145
150	68.8	520.4	110,000	129,100	70.1	522.3	99,400	129,100					150
155	67.9	518.4	103,600	128,400	69.2	520.4	93,400	128,600					155
160	66.9	516.2	97,600	127,600	68.2	518.4	87,700	128,100					160
165	66.0	514.0	91,900	126,800	67.3	516.3	82,300	128,100	69.3	518.9	68,100	124,300	165
170	65.0	511.6	86,600	125,900	66.4	514.0	77,300	126,900	68.3	516.9	63,500	124,100	170
175	64.0	509.1	81,700	125,100	65.4	511.7	72,600	126,300	67.4	514.8	59,200	124,000	175
180	63.1	506.6	77,000	124,300	64.4	509.3	68,200	125,700	66.5	512.5	55,100	123,800	180
185	62.1	503.9	72,500	123,400	63.5	506.8	64,000	125,000	65.5	510.2	51,300	121,800	185
190	61.1	501.1	68,300	122,600	62.5	504.1	60,000	124,400	64.5	507.8	47,700	116,800	190
195	60.1	498.2	64,300	121,700	61.5	501.4	56,200	121,000	63.6	505.3	44,200	112,100	195
200	59.1	495.2	60,500	120,900	60.5	498.5	52,600	116,300	62.6	502.7	40,900	107,600	200
205	58.1	492.0	56,900	117,500	59.5	495.6	49,200	111,800	61.6	500.0	37,800	103,400	205
210	57.0	488.7	53,500	113,100	58.5	492.5	46,000	107,600	60.6	497.1	34,900	99,400	210
215	56.0	485.3	50,200	108,900	57.5	489.2	42,900	103,500	59.6	494.1	32,100	95,500	215
220	54.9	481.8	47,100	104,900	56.4	485.9	40,000	99,700	58.6	491.1	29,400	91,800	220
225	53.9	478.1	44,100	101,100	55.4	482.4	37,100	96,000	57.6	487.9	26,800	88,300	225
230	52.8	474.3	41,200	97,500	54.3	478.8	34,400	92,500	56.5	484.5	24,300	85,000	230
235	51.7	470.3	38,500	94,000	53.2	475.0	31,900	89,100	55.5	481.0	22,000	81,800	235
240	50.5	466.1	35,900	90,700	52.1	471.1	29,400	85,900	54.4	477.4		78,700	240
245	49.4	461.8	33,400	87,500	51.0	467.0	27,000	82,800	53.3	473.7		75,800	245
250	48.2	457.3	31,000	84,400	49.9	462.8	24,700	79,800	52.2	469.8		72,900	250
255	47.1	452.6	28,600	81,500	48.7	458.4	22,500	77,000	51.1	465.7		70,200	255
260	45.8	447.8	26,400	78,600	47.5	453.8	20,400	74,200	50.0	461.5		67,600	260
265	44.6	442.7	24,200	75,900	46.3	449.0		71,600	48.8	457.1		65,100	265
270	43.3	437.3	22,200	73,300	45.1	443.9		69,000	47.7	452.5		62,700	270
275	42.1	431.8	20,200	70,800	43.9	438.7		66,600	46.5	447.7		60,400	275
280	40.7	425.9		68,300	42.6	433.3		64,200	45.3	442.8		58,100	280
290	38.0	413.4		63,700	39.9	421.5		59,700	42.7	432.1		53,800	290
300	35.0	399.5		59,400	37.1	408.6		55,500	40.1	420.5		49,900	300
310	31.8	383.9		55,300	34.1	394.2		51,600	37.3	407.6		46,100	310
320	28.2	366.0		51,500	30.8	378.0		47,900	34.2	393.3		42,600	320
330	24.2	345.0		47,900	27.1	359.4		44,400	31.0	377.2		39,300	330
340	19.4	319.0		44,400	22.9	337.2		41,100	27.3	358.7		36,200	340
350	12.9	282.6		39,700	17.7	309.0		38,000	23.2	336.7		33,200	350
360					10.2	266.3		34,900	18.1	309.0		30,300	360
370									10.7	267.7		27,500	370

# MLC650 VPC-MAX S-1

ASME B30.5

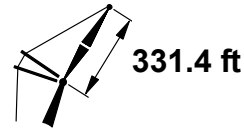
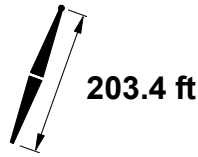

ft	75°			70°			ft
	ft	ft	lb	ft	lb	ft	
120							120
125							125
130							130
135							135
140							140
145							145
150							150
155							155
160							160
165							165
170							170
175							175
180							180
185							185
190							190
195							195
200							200
205	65.0	504.8	89,500				205
210	64.0	502.4	85,800				210
215	63.1	499.8	82,300				215
220	62.1	497.1	79,000				220
225	61.1	494.3	75,700				225
230	60.1	491.4	72,700				230
235	59.1	488.4	69,700				235
240	58.1	485.2	66,900				240
245	57.0	482.0	64,200				245
250	56.0	478.5	61,600	59.5	483.9	50,600	250
255	54.9	475.0	59,200	58.4	480.8	48,300	255
260	53.8	471.3	56,800	57.4	477.6	46,200	260
265	52.8	467.5	54,500	56.4	474.2	44,100	265
270	51.6	463.5	52,200	55.3	470.7	42,000	270
275	50.5	459.3	50,100	54.2	467.1	40,100	275
280	49.4	455.0	48,000	53.2	463.3	38,200	280
290	47.0	445.8	44,100	50.9	455.3	34,700	290
300	44.6	435.9	40,500	48.7	446.6	31,300	300
310	42.0	425.0	37,100	46.3	437.2	28,200	310
320	39.3	413.0	33,900	43.8	427.0	25,300	320
330	36.5	399.8	30,800	41.2	415.7	22,600	330
340	33.4	385.1	28,000	38.5	403.4	20,000	340
350	30.0	368.4	25,300				350
360	26.3	349.1	22,700				360
370	21.9	325.9	20,200				370

# MLC650 VPC-MAX S-1

ASME B30.5

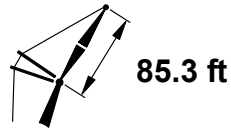
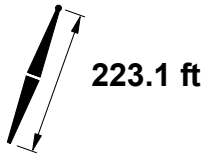

ft	85°				83°				80°				ft
	ft	lb	lb	lb	ft	lb	lb	lb	ft	lb	lb	lb	
55	74.3	313.7	445,600 d	721,000 d									55
60	70.7	311.8	401,200 c	665,300 c									60
65	67.1	309.6	364,200 c	603,600 c	72.7	312.0	342,700 c	586,500 c					65
70	63.3	306.9	332,900 c	551,900 c	69.1	309.9	313,000 c	536,200 c					70
75	59.3	303.9	305,900 b	508,000 b	65.4	307.5	287,600 c	493,500 c					75
80	55.2	300.3	282,400 b	470,200 b	61.5	304.7	265,400 b	456,700 b					80
85	50.8	296.1	261,800	437,300	57.5	301.4	246,000 b	424,700 b	66.6	306.4	222,200 c	406,100 c	85
90	46.1	291.2	243,600	408,400	53.3	297.5	228,800 b	396,700 b	62.7	303.7	206,500 b	379,200 b	90
95	41.0	285.3	227,200	382,800	48.8	293.0	213,400	371,800	58.8	300.6	192,500 b	355,400 b	95
100	35.1	278.2	212,400	359,900	43.9	287.7	199,500	349,600	54.6	296.9	179,900 b	334,100 b	100
105	28.1	269.0	198,900	339,300	38.4	281.4	186,900	329,600	50.2	292.6	168,500	315,100	105
110	18.5	255.5	186,100	320,600	32.2	273.5	175,400	311,600	45.4	287.6	158,100	297,800	110
115					24.3	262.9	164,600	295,100	40.2	281.6	148,600	282,200	115
120					11.1	243.8	153,900	279,800	34.2	274.3	139,700	267,800	120
125									27.0	264.7	131,400	254,600	125
130									16.6	250.1	123,200	242,300	130
135													135
140													140
145													145
150													150
155													155
160													160
165													165
170													170
175													175
180													180
185													185

# MLC650 VPC-MAX S-1

ASME B30.5

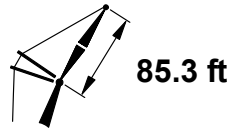
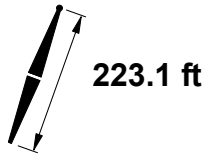

ft	75°				70°				65°				ft
	ft	°	ft	lb	ft	°	ft	lb	ft	°	ft	lb	
55													55
60													60
65													65
70													70
75													75
80													80
85													85
90													90
95													95
100													100
105													105
110	62.0	298.6	128,800 b	275,000 b									110
115	58.0	295.4	120,800 b	260,600 b									115
120	53.7	291.6	113,500 b	247,300 b									120
125	49.3	287.2	106,700	235,200									125
130	44.4	282.0	100,400	224,100									130
135	39.1	275.7	94,500	213,700	56.7	288.2	71,700	196,200					135
140	32.9	268.1	88,900	204,100	52.5	284.2	67,300	187,400					140
145	25.3	257.9	83,500	195,100	47.9	279.6	63,100	179,200					145
150	13.4	240.8	77,900	186,400	42.9	274.1	59,100	171,500					150
155					37.4	267.5	55,300	164,300	55.0	278.9	36,300	149,800	155
160					30.9	259.2	51,600	157,500	50.6	274.7	33,500	143,700	160
165					22.5	247.9	47,900	151,100	45.9	269.7	30,800	137,900	165
170									40.7	263.8	28,300	132,400	170
175									34.8	256.6	25,800	127,200	175
180									27.7	247.3	23,200	122,200	180
185									17.8	233.4	20,500	117,300	185

# MLC650 VPC-MAX S-1

ASME B30.5

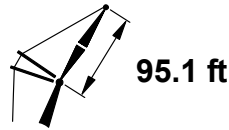
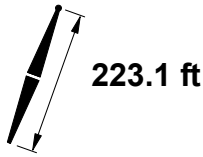

ft	85°				83°				80°				ft
	ft	lb	lb	lb	ft	lb	lb	lb	ft	lb	lb	lb	
60	72.8	322.3	398,600 c	661,400 c									60
65	69.6	320.4	361,700 c	600,000 c									65
70	66.3	318.1	330,400 b	548,700 b	71.4	320.6	310,200 c	532,700 c					70
75	62.9	315.4	303,500 b	505,000 b	68.1	318.5	284,800 b	490,300 b					75
80	59.4	312.3	280,200 b	467,400 b	64.8	316.0	262,800 b	453,700 b					80
85	55.7	308.8	259,700	434,700	61.3	313.2	243,500 b	421,900 b	69.2	317.3	219,100 b	403,000 b	85
90	51.8	304.8	241,600	405,900	57.7	309.9	226,400 b	394,000 b	65.8	314.9	203,500 b	376,200 b	90
95	47.7	300.1	225,400	380,500	54.0	306.1	211,100	369,300	62.4	312.2	189,600 b	352,600 b	95
100	43.3	294.7	210,800	357,800	50.0	301.8	197,400	347,200	58.9	309.1	177,200 b	331,500 b	100
105	38.4	288.4	197,600	337,400	45.8	296.9	185,000	327,400	55.2	305.5	165,900	312,500	105
110	32.9	280.7	185,500	319,000	41.1	291.1	173,700	309,500	51.3	301.3	155,700	295,400	110
115	26.2	270.8	174,300	302,200	36.0	284.2	163,300	293,300	47.1	296.6	146,300	279,900	115
120	16.9	256.2	163,600	286,700	30.1	275.6	153,600	278,400	42.6	291.1	137,600	265,700	120
125					22.6	264.2	144,500	264,700	37.7	284.6	129,600	252,700	125
130					9.5	243.2	135,400	251,800	32.0	276.6	122,100	240,700	130
135									25.2	266.3	115,000	229,600	135
140									15.1	250.4	108,000	219,100	140
145													145
150													150
155													155
160													160
165													165
170													170
175													175
180													180
185													185
190													190
195													195

# MLC650 VPC-MAX S-1

ASME B30.5

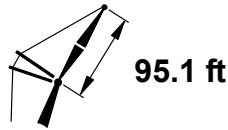
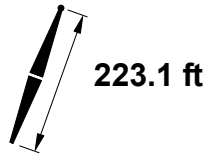

ft	75°				70°				65°				
	ft	ft	lb	lb	ft	ft	lb	lb	ft	ft	lb	ft	
60													60
65													65
70													70
75													75
80													80
85													85
90													90
95													95
100													100
105													105
110													110
115	61.7	307.1	117,700 b	257,800 b									115
120	58.1	303.9	110,500	244,700									120
125	54.4	300.2	103,800	232,700									125
130	50.4	295.9	97,700	221,600									130
135	46.2	291.1	91,900	211,400									135
140	41.7	285.4	86,500	201,900	57.0	296.7	64,000	184,700					140
145	36.6	278.6	81,400	193,100	53.2	292.9	60,000	176,600					145
150	30.8	270.3	76,600	184,900	49.2	288.4	56,100	169,100					150
155	23.5	259.3	71,900	177,100	44.9	283.3	52,500	162,000					155
160	11.9	240.7	66,900	169,500	40.2	277.4	49,000	155,400					160
165					35.0	270.2	45,700	149,100	51.6	283.4	135,300		165
170					28.8	261.3	42,500	143,200	47.5	278.7	129,900		170
175					20.8	249.0	39,200	137,400	43.0	273.2	124,800		175
180									38.1	266.8	120,000		180
185									32.6	259.0	115,400		185
190									25.8	249.0	111,000		190
195									16.3	234.0	106,600		195

# MLC650 VPC-MAX S-1

ASME B30.5



**440,900 lb**

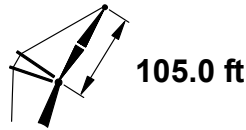
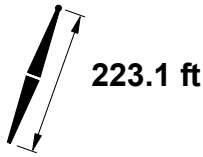

ft	85°				83°				80°				ft
	ft	lb	lb	lb	ft	lb	lb	lb	ft	lb	lb	lb	
60	74.5	332.7	397,100 c	654,300 c									60
65	71.6	331.0	360,300 c	597,400 c									65
70	68.7	328.9	329,100 b	546,300 b									70
75	65.7	326.6	302,300 b	502,800 b	70.3	329.2	283,300 b	488,000 b					75
80	62.6	323.9	279,000 b	465,400 b	67.3	327.0	261,300 b	451,600 b					80
85	59.4	320.8	258,600	432,900	64.3	324.5	242,100 b	420,000 b					85
90	56.0	317.4	240,600	404,300	61.1	321.6	225,100 b	392,200 b	68.3	325.8	201,900 b	374,200 b	90
95	52.6	313.4	224,500	379,000	57.9	318.4	209,900	367,600	65.2	323.4	188,100 b	350,700 b	95
100	48.9	309.0	210,000	356,400	54.5	314.7	196,300	345,700	62.1	320.6	175,700 b	329,700 b	100
105	45.0	303.9	197,000	336,200	51.0	310.6	184,000	326,000	58.9	317.5	164,500	310,900	105
110	40.9	298.1	185,100	317,900	47.2	305.9	172,800	308,200	55.6	314.0	154,300	293,900	110
115	36.2	291.2	174,200	301,200	43.2	300.5	162,600	292,100	52.1	310.0	145,100	278,500	115
120	31.0	282.9	164,100	286,100	38.8	294.2	153,200	277,400	48.4	305.5	136,600	264,400	120
125	24.6	272.4	154,700	272,100	34.0	286.8	144,500	263,900	44.5	300.3	128,700	251,500	125
130	15.6	256.7	145,600	259,100	28.3	277.6	136,300	251,400	40.2	294.4	121,400	239,600	130
135					21.1	265.4	128,500	239,800	35.5	287.3	114,600	228,700	135
140					8.1	242.2	120,500	228,800	30.2	278.8	108,200	218,500	140
145									23.6	267.8	102,000	209,000	145
150									13.8	250.7	95,900	199,900	150
155													155
160													160
165													165
170													170
175													175
180													180
185													185
190													190
195													195
200													200
205													205



# MLC650 VPC-MAX S-1

ASME B30.5

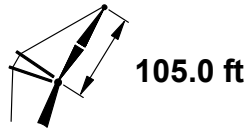
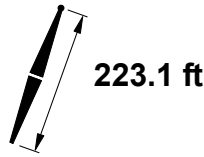

ft	75°				70°				65°			
	ft	lb	lb	lb	ft	lb	lb	lb	ft	lb	lb	ft
60												60
65												65
70												70
75												75
80												80
85												85
90												90
95												95
100												100
105												105
110												110
115	64.6	318.4	115,900	256,000								115
120	61.5	315.6	108,800	243,000								120
125	58.2	312.4	102,200	231,100								125
130	54.9	308.8	96,100	220,100								130
135	51.4	304.7	90,500	210,000								135
140	47.6	300.0	85,200	200,600								140
145	43.7	294.7	80,300	191,900	57.3	305.2	58,200	175,000				145
150	39.3	288.5	75,600	183,800	53.9	301.5	54,500	167,600				150
155	34.5	281.3	71,200	176,200	50.3	297.2	50,900	160,600				155
160	28.9	272.3	67,000	169,000	46.5	292.4	47,600	154,100				160
165	22.0	260.6	62,800	162,200	42.4	286.8	44,400	147,900				165
170	10.6	240.3	58,400	155,500	38.0	280.4	41,400	142,100	52.4	292.0	128,400	170
175					33.0	272.7	38,400	136,600	48.7	287.6	123,400	175
180					27.1	263.1	35,600	131,400	44.8	282.4	118,700	180
185					19.4	250.0	32,600	126,300	40.6	276.6	114,200	185
190									36.0	269.6	109,900	190
195									30.7	261.3	105,800	195
200									24.2	250.6	101,900	200
205									15.0	234.4	97,900	205

# MLC650 VPC-MAX S-1

ASME B30.5

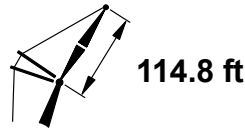
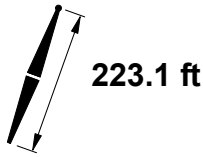

ft	85°				83°				80°				ft
	ft	lb	lb	lb	ft	lb	lb	lb	ft	lb	lb	lb	
65	73.3	341.4	357,600 b	593,800 b									65
70	70.6	339.6	326,500 b	543,000 b									70
75	67.9	337.5	299,700 b	499,700 b	72.1	339.7	280,400 b	484,700 b					75
80	65.1	335.1	276,500 b	462,500 b	69.4	337.7	258,500 b	448,500 b					80
85	62.3	332.3	256,200	430,100	66.7	335.5	239,400 b	417,100 b					85
90	59.4	329.3	238,200	401,700	63.9	333.0	222,400	389,400					90
95	56.4	325.9	222,200	376,500	61.0	330.1	207,300	365,000	67.5	334.3	185,000	347,800	95
100	53.2	322.0	207,800	354,100	58.0	326.9	193,800	343,200	64.7	331.9	172,700	326,900	100
105	49.9	317.8	194,800	333,900	55.0	323.3	181,500	323,600	61.9	329.1	161,600	308,200	105
110	46.5	312.9	183,000	315,700	51.8	319.3	170,400	305,900	59.0	326.0	151,500	291,300	110
115	42.8	307.5	172,300	299,200	48.4	314.7	160,300	289,900	55.9	322.5	142,400	276,000	115
120	38.8	301.2	162,400	284,100	44.8	309.6	151,000	275,200	52.8	318.7	133,900	262,000	120
125	34.3	293.9	153,200	270,300	41.0	303.8	142,400	261,800	49.5	314.3	126,200	249,200	125
130	29.3	285.1	144,700	257,500	36.8	297.1	134,500	249,500	46.0	309.4	119,000	237,400	130
135	23.2	273.8	136,600	245,700	32.2	289.2	127,000	238,100	42.2	303.8	112,300	226,500	135
140	14.4	257.0	128,800	234,700	26.7	279.5	120,000	227,500	38.2	297.4	106,000	216,500	140
145					19.8	266.5	113,300	217,600	33.7	289.9	100,200	207,100	145
150					6.7	240.8	106,300	208,000	28.5	280.9	94,600	198,300	150
155									22.2	269.2	89,200	190,100	155
160									12.7	250.8	83,800	182,200	160
165													165
170													170
175													175
180													180
185													185
190													190
195													195
200													200
205													205
210													210
215													215

# MLC650 VPC-MAX S-1

ASME B30.5

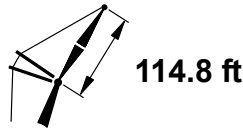
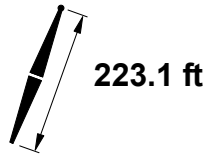

ft	75°				70°				65°			ft
	°	ft	lb	lb	°	ft	lb	lb	°	ft	lb	
65												65
70												70
75												75
80												80
85												85
90												90
95												95
100												100
105												105
110												110
115												115
120	64.2	326.9	105,500	240,200								120
125	61.3	324.0	99,000	228,400								125
130	58.4	320.9	93,000	217,500								130
135	55.3	317.3	87,500	207,500								135
140	52.1	313.3	82,300	198,200								140
145	48.8	308.9	77,500	189,500								145
150	45.2	303.8	72,900	181,500	57.5	313.7	51,200	164,900				150
155	41.4	298.1	68,700	174,000	54.4	310.0	47,700	158,000				155
160	37.3	291.5	64,600	166,900	51.1	305.9	44,500	151,500				160
165	32.7	283.7	60,700	160,300	47.7	301.3	41,400	145,500				165
170	27.4	274.3	57,000	154,000	44.1	296.1	38,500	139,700				170
175	20.6	261.8	53,300	148,000	40.3	290.1	35,700	134,300	53.0	300.7	120,800	175
180	9.4	239.7	49,300	142,000	36.0	283.2	33,000	129,200	49.8	296.3	116,200	180
185					31.2	275.0	30,400	124,300	46.3	291.5	111,700	185
190					25.6	264.9	27,800	119,700	42.6	286.0	107,500	190
195					18.2	250.9	25,200	115,100	38.5	279.6	103,600	195
200									34.1	272.3	99,700	200
205									29.0	263.4	96,000	205
210									22.8	252.0	92,500	210
215									13.8	234.6	88,900	215

# MLC650 VPC-MAX S-1

ASME B30.5

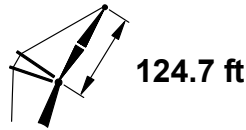
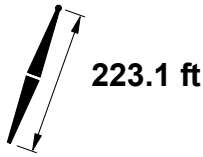

ft	85°				83°				80°				ft
	ft	lb	lb	lb	ft	lb	lb	lb	ft	lb	lb	lb	
65	74.6	351.8	420,900 b	552,400 b									65
70	72.2	350.1	384,900 b	541,700 b									70
75	69.7	348.2	354,100 b	498,700 b									75
80	67.2	346.0	327,300 b	461,600 b	71.1	348.3	309,000 b	447,600 b					80
85	64.7	343.5	303,800	429,400	68.6	346.3	286,800 b	416,300 b					85
90	62.1	340.8	283,100	401,100	66.1	344.0	267,100	388,800					90
95	59.4	337.8	264,700	376,000	63.5	341.4	249,600	364,400	69.4	345.1	227,000	347,200	95
100	56.6	334.4	248,100	353,700	60.9	338.6	233,900	342,700	66.9	342.8	212,500	326,400	100
105	53.7	330.6	233,200	333,600	58.1	335.4	219,700	323,200	64.3	340.4	199,500	307,800	105
110	50.8	326.5	219,700	315,500	55.3	331.8	206,900	305,600	61.7	337.6	187,700	290,900	110
115	47.6	321.8	207,400	299,000	52.4	327.9	195,200	289,600	59.0	334.5	176,900	275,700	115
120	44.3	316.6	196,000	284,000	49.4	323.5	184,400	275,100	56.2	331.1	167,000	261,800	120
125	40.8	310.8	185,600	270,300	46.2	318.7	174,600	261,800	53.3	327.3	158,000	249,000	125
130	36.9	304.1	176,000	257,700	42.7	313.2	165,500	249,500	50.3	323.0	149,600	237,300	130
135	32.7	296.3	167,000	246,000	39.1	307.0	157,000	238,200	47.2	318.3	141,800	226,500	135
140	27.8	287.0	158,600	235,200	35.1	299.9	149,100	227,700	43.8	313.1	134,600	216,500	140
145	21.9	275.2	150,700	225,100	30.6	291.5	141,700	217,900	40.3	307.1	127,800	207,200	145
150	13.4	257.3	142,900	215,600	25.4	281.2	134,700	208,800	36.4	300.3	121,500	198,500	150
155					18.6	267.4	127,900	200,200	32.1	292.3	115,500	190,400	155
160					5.2	238.6	120,800	191,900	27.1	282.8	109,800	182,800	160
165									21.0	270.4	104,400	175,600	165
170									11.6	250.7	98,800	168,700	170
175													175
180													180
185													185
190													190
195													195
200													200
205													205
210													210
215													215
220													220
225													225

# MLC650 VPC-MAX S-1

ASME B30.5

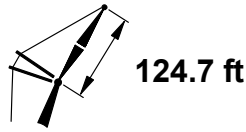
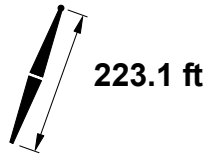

ft	75°				70°				65°			
	ft	lb	ft	lb	ft	lb	ft	lb	ft	lb	ft	
65												65
70												70
75												75
80												80
85												85
90												90
95												95
100												100
105												105
110												110
115												115
120												120
125	63.8	335.3	130,400	228,100								125
130	61.2	332.5	123,200	217,300								130
135	58.4	329.3	116,600	207,300								135
140	55.6	325.8	110,400	198,000								140
145	52.7	322.0	104,600	189,500								145
150	49.7	317.6	99,200	181,500								150
155	46.5	312.8	94,200	174,000	57.6	322.2	72,900	157,900				155
160	43.1	307.4	89,400	167,000	54.8	318.6	68,900	151,400				160
165	39.5	301.3	84,900	160,400	51.9	314.6	65,100	145,400				165
170	35.5	294.3	80,600	154,200	48.8	310.1	61,500	139,700				170
175	31.1	286.1	76,500	148,400	45.5	305.2	58,100	134,400				175
180	26.0	276.0	72,500	142,800	42.1	299.6	54,900	129,300	53.6	309.3	116,100	180
185	19.5	262.8	68,600	137,500	38.4	293.2	51,800	124,600	50.6	305.1	111,700	185
190	8.2	238.9	64,400	132,200	34.3	285.9	48,800	120,000	47.5	300.4	107,600	190
195					29.7	277.2	46,000	115,600	44.1	295.2	103,600	195
200					24.2	266.4	43,100	111,500	40.6	289.3	99,900	200
205					17.0	251.6	40,300	107,400	36.7	282.6	96,300	205
210									32.5	274.7	92,900	210
215									27.6	265.3	89,500	215
220									21.6	253.3	86,300	220
225									12.8	234.8	83,000	225

# MLC650 VPC-MAX S-1

ASME B30.5

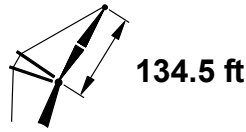
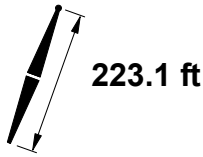

ft	85°				83°				80°				ft
	ft	lb	lb	lb	ft	lb	lb	lb	ft	lb	lb	lb	
70	73.6	360.5	382,300 b	518,600 b									70
75	71.3	358.7	351,500 b	495,600 b									75
80	69.0	356.7	324,800	458,800	72.6	358.8	306,200 b	444,500 b					80
85	66.7	354.5	301,400	426,700	70.3	356.9	284,000	413,400					85
90	64.3	352.0	280,700	398,500	68.0	354.8	264,400	386,000					90
95	61.9	349.3	262,300	373,500	65.6	352.5	246,900	361,800					95
100	59.4	346.3	245,800	351,300	63.2	349.9	231,200	340,100	68.7	353.6	209,600	323,600	100
105	56.8	342.9	230,900	331,300	60.8	347.0	217,100	320,700	66.4	351.4	196,600	305,100	105
110	54.2	339.2	217,400	313,200	58.2	343.9	204,300	303,200	64.0	348.8	184,800	288,300	110
115	51.4	335.2	205,100	296,900	55.7	340.4	192,700	287,300	61.5	346.1	174,100	273,100	115
120	48.6	330.7	193,900	281,900	53.0	336.5	182,000	272,800	59.0	343.0	164,300	259,300	120
125	45.6	325.7	183,600	268,300	50.2	332.3	172,200	259,600	56.5	339.6	155,300	246,600	125
130	42.4	320.2	174,000	255,700	47.3	327.6	163,200	247,400	53.8	335.9	146,900	235,000	130
135	39.0	314.0	165,200	244,100	44.2	322.4	154,800	236,100	51.1	331.7	139,200	224,200	135
140	35.3	306.9	156,900	233,400	40.9	316.6	147,000	225,700	48.2	327.2	132,100	214,300	140
145	31.2	298.7	149,200	223,400	37.4	310.0	139,700	216,000	45.2	322.2	125,400	205,100	145
150	26.5	288.9	141,900	214,100	33.5	302.4	132,900	207,000	42.0	316.5	119,200	196,500	150
155	20.8	276.4	134,900	205,300	29.2	293.6	126,400	198,600	38.5	310.2	113,300	188,400	155
160	12.4	257.4	128,100	197,000	24.1	282.8	120,300	190,600	34.8	303.0	107,800	180,900	160
165					17.6	268.2	114,300	183,100	30.6	294.6	102,500	173,800	165
170					2.9	234.3	107,700	175,700	25.8	284.5	97,500	167,100	170
175									19.9	271.5	92,600	160,700	175
180									10.7	250.5	87,600	154,600	180
185													185
190													190
195													195
200													200
205													205
210													210
215													215
220													220
225													225
230													230
235													235

# MLC650 VPC-MAX S-1

ASME B30.5

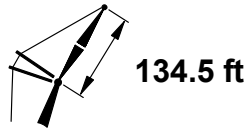
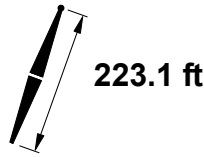

ft	75°				70°				65°			
	ft	ft	lb	lb	ft	lb	lb	ft	lb	ft	ft	
70												70
75												75
80												80
85												85
90												90
95												95
100												100
105												105
110												110
115												115
120												120
125												125
130	63.5	343.8	120,100	214,600								130
135	61.0	341.0	113,500	204,700								135
140	58.5	337.8	107,400	195,500								140
145	55.9	334.4	101,700	187,000								145
150	53.3	330.6	96,300	179,100								150
155	50.5	326.4	91,300	171,600								155
160	47.6	321.7	86,600	164,700	57.8	330.7	65,600	148,900				160
165	44.5	316.6	82,200	158,200	55.2	327.2	61,900	142,900				165
170	41.3	310.8	78,000	152,100	52.5	323.2	58,400	137,300				170
175	37.8	304.3	74,000	146,300	49.6	318.9	55,100	132,000				175
180	34.0	296.9	70,200	140,800	46.7	314.1	51,900	127,000				180
185	29.7	288.3	66,500	135,600	43.6	308.8	48,900	122,200	54.0	317.8	109,100	185
190	24.7	277.7	63,000	130,700	40.3	302.9	46,100	117,800	51.3	313.8	105,000	190
195	18.4	263.7	59,400	125,900	36.7	296.1	43,300	113,500	48.4	309.3	101,200	195
200	7.2	237.8	55,600	121,100	32.8	288.4	40,700	109,400	45.4	304.3	97,500	200
205					28.3	279.2	38,100	105,500	42.2	298.7	93,900	205
210					23.1	267.9	35,500	101,700	38.8	292.4	90,600	210
215					16.1	252.2	32,900	98,000	35.1	285.3	87,300	215
220									31.0	277.1	84,200	220
225									26.3	267.1	81,200	225
230									20.5	254.4	78,300	230
235									11.8	234.7	75,300	235

# MLC650 VPC-MAX S-1

ASME B30.5

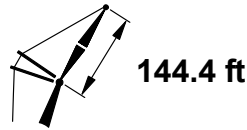
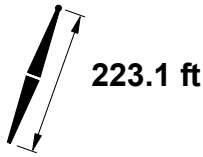

ft	85°				83°				80°				ft
	ft	lb	lb	lb	ft	lb	lb	lb	ft	lb	lb	lb	
70	74.7	370.8	380,400 b	507,000 b									70
75	72.6	369.2	349,600 b	493,100 b									75
80	70.5	367.4	322,900	456,400									80
85	68.4	365.3	299,600	424,400	71.7	367.5	282,100	411,100					85
90	66.2	363.0	278,900	396,400	69.6	365.5	262,500	383,800					90
95	64.0	360.5	260,500	371,500	67.4	363.4	245,000	359,700					95
100	61.7	357.8	244,100	349,300	65.2	361.0	229,400	338,100					100
105	59.4	354.7	229,300	329,400	63.0	358.4	215,300	318,800	68.1	362.2	194,600	303,000	105
110	57.0	351.4	215,800	311,400	60.7	355.5	202,600	301,400	65.9	359.9	182,800	286,400	110
115	54.6	347.8	203,600	295,100	58.3	352.3	191,000	285,500	63.7	357.3	172,100	271,300	115
120	52.0	343.8	192,400	280,300	55.9	348.9	180,300	271,100	61.4	354.5	162,400	257,500	120
125	49.4	339.5	182,100	266,700	53.4	345.1	170,600	257,900	59.1	351.5	153,400	244,800	125
130	46.7	334.7	172,600	254,200	50.9	341.0	161,600	245,800	56.7	348.1	145,100	233,300	130
135	43.8	329.4	163,800	242,600	48.2	336.4	153,200	234,600	54.2	344.4	137,500	222,600	135
140	40.7	323.5	155,600	231,900	45.4	331.4	145,500	224,200	51.7	340.4	130,400	212,700	140
145	37.4	317.0	148,000	222,000	42.4	325.9	138,300	214,600	49.0	336.0	123,700	203,500	145
150	33.9	309.5	140,800	212,800	39.3	319.8	131,500	205,600	46.3	331.2	117,500	194,900	150
155	29.9	300.9	134,100	204,100	35.9	312.8	125,200	197,200	43.4	325.8	111,700	186,900	155
160	25.4	290.6	127,700	196,000	32.2	304.9	119,200	189,400	40.3	319.9	106,300	179,500	160
165	19.8	277.5	121,600	188,300	28.0	295.6	113,500	182,000	37.0	313.2	101,100	172,400	165
170	11.6	257.3	115,500	181,000	23.1	284.3	108,100	175,000	33.4	305.6	96,200	165,800	170
175					16.7	269.0	102,800	168,400	29.3	296.8	91,600	159,600	175
180									24.7	286.2	87,100	153,600	180
185									18.9	272.5	82,700	148,000	185
190									9.8	250.1	78,200	142,500	190
195													195
200													200
205													205
210													210
215													215
220													220
225													225
230													230
235													235
240													240
245													245



# MLC650 VPC-MAX S-1

ASME B30.5

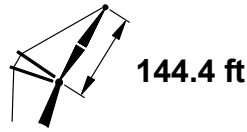
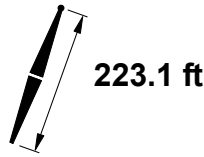

ft	75°				70°				65°				
	ft	lb	lb	lb	ft	lb	lb	lb	ft	lb	lb	ft	
70													70
75													75
80													80
85													85
90													90
95													95
100													100
105													105
110													110
115													115
120													120
125													125
130													130
135	63.2	352.3	111,400	202,800									135
140	60.9	349.4	105,300	193,700									140
145	58.6	346.3	99,600	185,200									145
150	56.2	342.9	94,400	177,300									150
155	53.7	339.2	89,400	170,000									155
160	51.1	335.1	84,700	163,100									160
165	48.5	330.6	80,300	156,600	57.9	339.2	59,800	141,100					165
170	45.7	325.6	76,200	150,500	55.5	335.7	56,400	135,600					170
175	42.7	320.2	72,300	144,800	53.0	331.8	53,100	130,300					175
180	39.6	314.1	68,500	139,400	50.4	327.6	50,000	125,300					180
185	36.3	307.2	65,000	134,300	47.7	323.0	47,000	120,600					185
190	32.6	299.4	61,600	129,400	44.8	317.9	44,200	116,200	54.4	326.4	103,300		190
195	28.5	290.3	58,300	124,800	41.8	312.3	41,500	112,000	51.9	322.4	99,500		195
200	23.6	279.2	55,100	120,300	38.7	306.0	38,900	108,000	49.3	318.0	95,800		200
205	17.5	264.6	51,900	116,000	35.2	298.9	36,500	104,100	46.5	313.2	92,300		205
210	6.0	236.2	48,300	111,700	31.4	290.8	34,100	100,400	43.6	307.9	89,000		210
215					27.1	281.2	31,700	96,900	40.5	302.0	85,800		215
220					22.0	269.3	29,400	93,500	37.3	295.4	82,800		220
225					15.2	252.7	27,000	90,200	33.7	287.9	79,800		225
230									29.7	279.3	77,000		230
235									25.1	268.9	74,300		235
240									19.5	255.5	71,600		240
245									10.9	234.6	68,900		245

# MLC650 VPC-MAX S-1

ASME B30.5



**440,900 lb**

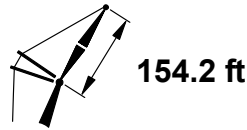
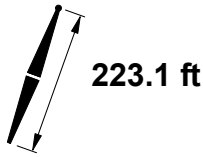

ft	85°				83°				80°				ft
	ft	lb	lb	lb	ft	lb	lb	lb	ft	lb	lb	lb	
75	73.8	379.6	347,100	470,000									75
80	71.8	377.9	320,400	453,500									80
85	69.8	376.0	297,100	421,700	72.9	377.9	279,300	408,200					85
90	67.8	373.9	276,400	393,800	70.9	376.1	259,700	381,100					90
95	65.8	371.5	258,100	369,000	68.9	374.1	242,300	357,000					95
100	63.7	369.0	241,700	346,900	66.9	371.9	226,700	335,600					100
105	61.6	366.2	226,900	327,100	64.8	369.5	212,700	316,300	69.6	372.9	191,600	300,400	105
110	59.4	363.2	213,500	309,200	62.7	366.9	200,000	299,000	67.5	370.7	179,900	283,800	110
115	57.2	359.9	201,200	292,900	60.6	364.0	188,400	283,200	65.5	368.4	169,300	268,700	115
120	54.9	356.3	190,100	278,100	58.4	360.8	177,800	268,800	63.4	365.8	159,600	255,000	120
125	52.5	352.4	179,800	264,600	56.2	357.4	168,100	255,700	61.3	363.0	150,600	242,400	125
130	50.1	348.2	170,400	252,100	53.8	353.7	159,100	243,600	59.1	359.9	142,400	230,900	130
135	47.6	343.6	161,600	240,600	51.5	349.6	150,900	232,400	56.9	356.6	134,800	220,200	135
140	44.9	338.5	153,500	230,000	49.0	345.2	143,200	222,100	54.6	353.0	127,700	210,400	140
145	42.1	332.9	145,900	220,100	46.4	340.4	136,000	212,500	52.2	349.0	121,100	201,300	145
150	39.2	326.7	138,800	210,900	43.7	335.1	129,300	203,600	49.8	344.8	115,000	192,700	150
155	36.0	319.8	132,200	202,300	40.8	329.3	123,000	195,300	47.2	340.1	109,200	184,800	155
160	32.6	312.0	125,900	194,300	37.8	322.8	117,100	187,500	44.5	334.9	103,800	177,400	160
165	28.8	303.0	120,000	186,700	34.5	315.5	111,500	180,200	41.7	329.3	98,700	170,400	165
170	24.3	292.3	114,300	179,600	30.9	307.2	106,200	173,300	38.8	323.0	93,900	163,800	170
175	18.9	278.5	108,900	172,800	26.9	297.5	101,200	166,800	35.6	316.0	89,400	157,700	175
180	10.8	257.2	103,400	166,300	22.1	285.6	96,300	160,600	32.1	308.1	85,000	151,800	180
185					15.8	269.6	91,600	154,700	28.2	298.8	80,900	146,300	185
190									23.7	287.8	76,900	141,000	190
195									18.0	273.4	72,900	135,900	195
200									9.0	249.5	68,800	131,000	200
205													205
210													210
215													215
220													220
225													225
230													230
235													235
240													240
245													245
250													250
255													255

# MLC650 VPC-MAX S-1

ASME B30.5

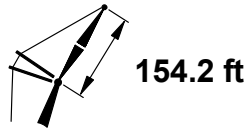
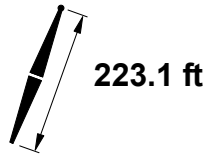

ft	75°				70°				65°			
	ft	lb	ft	lb	ft	lb	ft	lb	ft	lb	ft	
75												75
80												80
85												85
90												90
95												95
100												100
105												105
110												110
115												115
120												120
125												125
130												130
135												135
140	63.0	360.8	102,200	191,200								140
145	60.8	357.9	96,600	182,700								145
150	58.6	354.8	91,400	174,900								150
155	56.4	351.4	86,400	167,600								155
160	54.1	347.7	81,800	160,700								160
165	51.7	343.7	77,500	154,300								165
170	49.2	339.3	73,400	148,300	58.0	347.7	53,200	133,000				170
175	46.7	334.6	69,500	142,600	55.7	344.2	49,900	127,800				175
180	44.0	329.3	65,900	137,200	53.4	340.4	46,900	122,900				180
185	41.2	323.6	62,400	132,100	51.0	336.3	44,000	118,300				185
190	38.1	317.2	59,100	127,300	48.5	331.8	41,200	113,800				190
195	34.9	310.0	55,900	122,700	45.9	326.9	38,600	109,700	54.8	335.0	96,900	195
200	31.3	301.8	52,800	118,400	43.2	321.6	36,100	105,700	52.4	331.0	93,300	200
205	27.3	292.3	49,800	114,200	40.3	315.6	33,700	101,900	50.0	326.8	89,900	205
210	22.6	280.7	47,000	110,200	37.2	309.0	31,400	98,300	47.4	322.1	86,600	210
215	16.6	265.3	44,100	106,300	33.9	301.6	29,100	94,800	44.8	317.0	83,500	215
220	4.9	234.1	40,700	102,300	30.2	293.0	26,900	91,500	42.0	311.4	80,500	220
225					26.0	283.0	24,800	88,300	39.0	305.2	77,600	225
230					21.1	270.6	22,700	85,200	35.9	298.3	74,800	230
235					14.3	253.2	20,500	82,100	32.4	290.4	72,100	235
240									28.5	281.3	69,600	240
245									24.1	270.5	67,100	245
250									18.6	256.5	64,600	250
255									10.1	234.3	62,100	255

# MLC650 VPC-MAX S-1

ASME B30.5



440,900 lb



360°

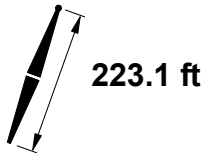

223.1 ft



164.0 ft

ft	85°				83°				80°				ft
	ft	lb	lb	lb	ft	lb	lb	lb	ft	lb	lb	lb	
75	74.8	389.9	346,400	432,900									75
80	73.0	388.3	319,700	432,900									80
85	71.1	386.5	296,400	420,400									85
90	69.2	384.6	275,800	392,500	72.1	386.6	258,900	379,700					90
95	67.3	382.4	257,500	367,900	70.3	384.7	241,600	355,800					95
100	65.4	380.1	241,100	345,900	68.4	382.7	226,000	334,500					100
105	63.4	377.5	226,300	326,100	66.5	380.4	212,000	315,300					105
110	61.4	374.7	212,900	308,300	64.5	378.0	199,300	298,000	69.0	381.4	179,100	282,700	110
115	59.4	371.7	200,700	292,100	62.5	375.3	187,800	282,300	67.1	379.3	168,500	267,700	115
120	57.3	368.4	189,600	277,300	60.5	372.5	177,200	267,900	65.1	376.9	158,800	254,000	120
125	55.2	364.9	179,400	263,800	58.5	369.3	167,500	254,800	63.2	374.3	149,900	241,500	125
130	53.0	361.0	169,900	251,400	56.4	365.9	158,600	242,800	61.2	371.5	141,700	230,000	130
135	50.7	356.9	161,200	239,900	54.2	362.3	150,300	231,700	59.1	368.4	134,100	219,400	135
140	48.4	352.4	153,100	229,300	52.0	358.3	142,700	221,400	57.0	365.1	127,000	209,600	140
145	45.9	347.5	145,600	219,500	49.7	354.0	135,500	211,900	54.9	361.5	120,500	200,500	145
150	43.4	342.1	138,500	210,300	47.3	349.3	128,900	203,000	52.7	357.7	114,400	192,000	150
155	40.7	336.3	131,900	201,800	44.8	344.2	122,600	194,700	50.4	353.5	108,700	184,100	155
160	37.8	329.8	125,700	193,800	42.2	338.6	116,800	186,900	48.0	348.9	103,300	176,700	160
165	34.7	322.6	119,900	186,300	39.4	332.5	111,200	179,700	45.6	344.0	98,200	169,800	165
170	31.4	314.4	114,400	179,200	36.5	325.7	106,000	172,800	43.0	338.5	93,500	163,200	170
175	27.7	305.0	109,100	172,500	33.3	318.1	101,100	166,400	40.3	332.6	89,000	157,100	175
180	23.4	293.8	104,100	166,200	29.8	309.5	96,400	160,200	37.4	326.0	84,700	151,300	180
185	18.1	279.4	99,200	160,200	25.8	299.3	91,900	154,500	34.3	318.7	80,600	145,800	185
190	10.0	256.9	94,300	154,400	21.2	286.9	87,500	149,000	30.9	310.4	76,700	140,600	190
195					15.1	270.1	83,300	143,700	27.1	300.8	73,000	135,600	195
200									22.7	289.2	69,400	130,900	200
205									17.2	274.2	65,800	126,300	205
210									8.2	248.8	62,100	121,800	210
215													215
220													220
225													225
230													230
235													235
240													240
245													245
250													250
255													255
260													260
265													265

# MLC650 VPC-MAX S-1

ASME B30.5

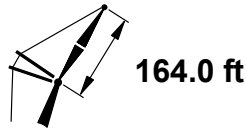
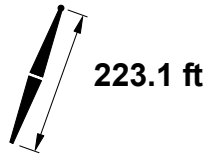

ft	75°				70°				65°			
	ft	lb	ft	lb	ft	lb	ft	lb	ft	lb	ft	
75												75
80												80
85												85
90												90
95												95
100												100
105												105
110												110
115												115
120												120
125												125
130												130
135												135
140	64.7	371.9	101,300	190,200								140
145	62.8	369.2	95,700	181,800								145
150	60.8	366.4	90,500	174,000								150
155	58.7	363.3	85,600	166,700								155
160	56.6	359.9	81,000	159,900								160
165	54.4	356.3	76,700	153,500								165
170	52.2	352.3	72,700	147,500								170
175	49.9	348.1	68,800	141,900	58.1	356.2	49,000	127,000				175
180	47.5	343.4	65,200	136,500	56.0	352.7	46,000	122,100				180
185	45.1	338.4	61,700	131,500	53.8	349.0	43,100	117,400				185
190	42.5	332.9	58,500	126,700	51.5	345.0	40,400	113,100				190
195	39.7	326.8	55,300	122,200	49.2	340.6	37,800	108,900				195
200	36.8	320.1	52,400	117,800	46.8	335.9	35,300	105,000				200
205	33.6	312.6	49,500	113,700	44.3	330.7	32,900	101,200	52.9	339.7	89,100	205
210	30.2	304.1	46,700	109,800	41.7	325.0	30,700	97,700	50.6	335.5	85,800	210
215	26.3	294.1	44,000	106,000	38.9	318.8	28,500	94,200	48.2	331.0	82,700	215
220	21.7	282.1	41,400	102,400	35.9	311.9	26,400	91,000	45.8	326.0	79,700	220
225	15.8	265.9	38,700	98,900	32.7	304.1	24,300	87,800	43.2	320.7	76,900	225
230	3.4	230.6	35,600	95,200	29.1	295.2	22,400	84,800	40.5	314.8	74,200	230
235					25.0	284.7	20,400	81,900	37.7	308.3	71,500	235
240					20.2	271.7		79,000	34.6	301.0	69,000	240
245					13.6	253.5		76,200	31.2	292.8	66,600	245
250									27.5	283.3	64,200	250
255									23.2	272.0	61,900	255
260									17.8	257.4	59,600	260
265									9.4	233.9	57,300	265

# MLC650 VPC-MAX S-1

ASME B30.5



440,900 lb

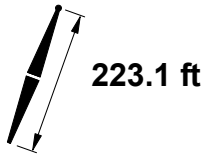

223.1 ft

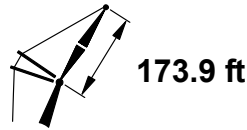

173.9 ft

ft	85°				83°				80°				ft
	ft	lb	lb	lb	ft	lb	lb	lb	ft	lb	lb	lb	
80	74.0	398.6	317,200	400,600									80
85	72.2	397.0	293,900	400,000									85
90	70.5	395.1	273,300	389,900									90
95	68.7	393.1	255,000	365,400	71.4	395.2	238,900	353,200					95
100	66.9	390.9	238,600	343,400	69.7	393.3	223,300	331,900					100
105	65.1	388.6	223,900	323,800	67.9	391.2	209,400	312,800					105
110	63.2	386.0	210,500	306,000	66.1	389.0	196,700	295,600					110
115	61.3	383.2	198,400	289,900	64.2	386.5	185,200	279,900	68.4	390.0	165,600	265,100	115
120	59.4	380.2	187,200	275,100	62.4	383.8	174,700	265,700	66.6	387.8	155,900	251,500	120
125	57.4	376.9	177,000	261,700	60.5	380.9	165,000	252,600	64.8	385.4	147,000	239,100	125
130	55.4	373.4	167,600	249,300	58.5	377.8	156,100	240,600	63.0	382.8	138,900	227,600	130
135	53.4	369.6	158,900	237,900	56.5	374.4	147,900	229,500	61.1	380.0	131,300	217,100	135
140	51.2	365.6	150,900	227,300	54.5	370.8	140,200	219,300	59.1	376.9	124,300	207,300	140
145	49.1	361.2	143,400	217,500	52.4	366.9	133,100	209,800	57.2	373.6	117,800	198,200	145
150	46.8	356.4	136,400	208,400	50.3	362.7	126,500	200,900	55.2	370.1	111,700	189,800	150
155	44.4	351.3	129,800	199,900	48.0	358.1	120,300	192,700	53.1	366.3	106,100	181,900	155
160	41.9	345.6	123,700	191,900	45.7	353.2	114,500	185,000	50.9	362.1	100,700	174,600	160
165	39.3	339.5	117,900	184,400	43.3	347.9	109,000	177,700	48.7	357.7	95,700	167,700	165
170	36.6	332.7	112,400	177,400	40.8	342.0	103,800	170,900	46.5	352.9	91,000	161,200	170
175	33.6	325.2	107,200	170,800	38.1	335.6	98,900	164,500	44.1	347.7	86,500	155,100	175
180	30.3	316.7	102,300	164,500	35.3	328.5	94,300	158,400	41.6	342.0	82,300	149,300	180
185	26.7	307.0	97,600	158,600	32.2	320.6	89,900	152,700	39.0	335.8	78,300	143,900	185
190	22.5	295.3	93,100	153,000	28.8	311.6	85,700	147,300	36.2	328.9	74,500	138,700	190
195	17.3	280.3	88,700	147,600	24.9	301.1	81,600	142,100	33.2	321.3	70,800	133,800	195
200	9.3	256.5	84,200	142,400	20.4	288.2	77,700	137,100	29.9	312.6	67,300	129,100	200
205					14.3	270.6	73,800	132,400	26.2	302.6	63,900	124,600	205
210									21.9	290.6	60,700	120,400	210
215									16.5	275.0	57,400	116,200	215
220									7.4	247.9	54,000	112,100	220
225													225
230													230
235													235
240													240
245													245
250													250
255													255
260													260
265													265
270													270
275													275

# MLC650 VPC-MAX S-1

ASME B30.5

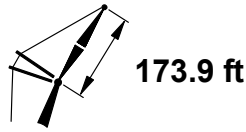
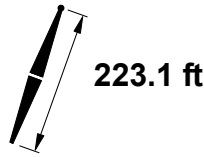

ft	75°				70°				65°			
	ft	lb	ft	lb	ft	lb	ft	lb	ft	lb	ft	
80												80
85												85
90												90
95												95
100												100
105												105
110												110
115												115
120												120
125												125
130												130
135												135
140												140
145	64.4	380.4	92,600	179,300								145
150	62.6	377.7	87,400	171,500								150
155	60.7	374.9	82,600	164,300								155
160	58.7	371.8	78,100	157,500								160
165	56.8	368.4	73,800	151,200								165
170	54.7	364.8	69,800	145,200								170
175	52.7	361.0	66,000	139,600								175
180	50.5	356.8	62,400	134,300	58.2	364.7	42,800	119,600				180
185	48.3	352.3	59,000	129,300	56.2	361.3	40,000	115,000				185
190	46.0	347.4	55,800	124,500	54.1	357.6	37,300	110,700				190
195	43.6	342.1	52,700	120,000	52.0	353.6	34,800	106,600				195
200	41.1	336.3	49,700	115,800	49.9	349.4	32,300	102,700				200
205	38.4	330.0	46,900	111,700	47.6	344.7	30,000	98,900				205
210	35.6	323.0	44,200	107,800	45.3	339.7	27,800	95,400	53.3	348.3	83,300	210
215	32.5	315.1	41,600	104,100	42.9	334.3	25,700	92,000	51.1	344.2	80,300	215
220	29.2	306.3	39,100	100,500	40.3	328.4	23,600	88,800	48.9	339.8	77,300	220
225	25.4	295.9	36,700	97,100	37.6	321.8	21,600	85,700	46.7	335.0	74,500	225
230	20.9	283.3	34,300	93,800	34.7	314.6		82,700	44.3	329.8	71,800	230
235	15.1	266.5	31,800	90,600	31.6	306.5		79,900	41.8	324.2	69,200	235
240					28.1	297.2		77,100	39.2	318.0	66,800	240
245					24.1	286.3		74,400	36.4	311.2	64,400	245
250					19.4	272.8		71,800	33.4	303.6	62,100	250
255					12.9	253.7		69,200	30.2	295.1	59,800	255
260									26.5	285.2	57,700	260
265									22.3	273.4	55,500	265
270									17.0	258.2	53,400	270
275									8.6	233.3	51,300	275

# MLC650 VPC-MAX S-1

ASME B30.5

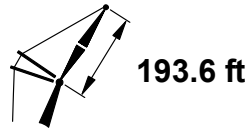
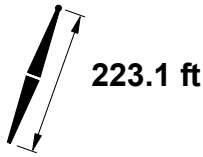

ft	85°				83°				80°				ft
	ft	lb	lb	lb	ft	lb	lb	lb	ft	lb	lb	lb	
85	74.1	417.7	290,600	340,700									85
90	72.5	416.1	270,100	340,600									90
95	71.0	414.3	251,800	339,800									95
100	69.4	412.4	235,500	339,100	71.8	414.4	219,800	328,100					100
105	67.8	410.3	220,800	320,400	70.3	412.5	205,900	309,200					105
110	66.2	408.0	207,400	302,700	68.7	410.5	193,300	292,100					110
115	64.5	405.6	195,300	286,700	67.1	408.3	181,800	276,500					115
120	62.8	402.9	184,200	272,100	65.4	406.0	171,300	262,400	69.2	409.2	152,100	248,000	120
125	61.1	400.1	174,000	258,700	63.8	403.5	161,700	249,400	67.6	407.1	143,300	235,600	125
130	59.4	397.1	164,700	246,400	62.1	400.8	152,800	237,500	65.9	404.8	135,200	224,300	130
135	57.7	393.9	156,000	235,000	60.4	397.9	144,700	226,500	64.3	402.4	127,700	213,800	135
140	55.9	390.5	148,000	224,500	58.6	394.8	137,100	216,300	62.6	399.7	120,800	204,100	140
145	54.0	386.8	140,500	214,800	56.9	391.5	130,000	206,900	60.9	396.9	114,300	195,100	145
150	52.1	382.8	133,600	205,700	55.0	387.9	123,400	198,100	59.2	393.9	108,300	186,700	150
155	50.2	378.6	127,100	197,300	53.2	384.1	117,300	189,900	57.4	390.6	102,600	178,900	155
160	48.2	374.1	121,000	189,400	51.3	380.0	111,500	182,200	55.6	387.1	97,400	171,600	160
165	46.1	369.2	115,200	181,900	49.3	375.7	106,100	175,100	53.8	383.4	92,400	164,800	165
170	44.0	364.0	109,800	175,000	47.3	371.0	101,000	168,300	51.9	379.4	87,700	158,300	170
175	41.8	358.4	104,700	168,400	45.2	366.0	96,200	161,900	49.9	375.2	83,300	152,300	175
180	39.4	352.3	99,900	162,200	43.0	360.6	91,600	155,900	47.9	370.6	79,200	146,600	180
185	37.0	345.6	95,300	156,400	40.7	354.8	87,300	150,300	45.9	365.7	75,200	141,200	185
190	34.4	338.3	91,000	150,800	38.3	348.4	83,200	144,900	43.7	360.4	71,500	136,100	190
195	31.5	330.2	86,800	145,500	35.8	341.5	79,300	139,800	41.5	354.7	67,900	131,200	195
200	28.4	321.0	82,800	140,500	33.1	333.8	75,500	135,000	39.1	348.6	64,500	126,600	200
205	25.0	310.5	79,000	135,800	30.2	325.3	71,900	130,300	36.6	341.8	61,300	122,200	205
210	21.0	297.9	75,300	131,200	26.9	315.6	68,500	125,900	34.0	334.4	58,200	118,100	210
215	16.0	281.7	71,700	126,800	23.3	304.2	65,200	121,700	31.1	326.2	55,200	114,100	215
220	8.0	255.2	67,900	122,500	18.9	290.3	61,900	117,700	28.0	316.8	52,300	110,200	220
225					13.1	271.2	58,700	113,700	24.5	306.1	49,500	106,600	225
230									20.4	293.1	46,800	103,000	230
235									15.1	276.2	44,000	99,600	235
240									5.9	245.3	41,000	96,100	240
245													245
250													250
255													255
260													260
265													265
270													270
275													275
280													280
290													290



# MLC650 VPC-MAX S-1

ASME B30.5

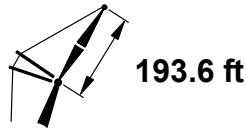
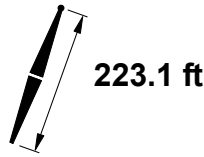

ft	75°				70°				65°			
	ft	lb	ft	lb	ft	lb	ft	lb	ft	lb	ft	
85												85
90												90
95												95
100												100
105												105
110												110
115												115
120												120
125												125
130												130
135												135
140												140
145												145
150												150
155	63.9	397.4	78,600	160,900								155
160	62.3	394.7	74,100	154,200								160
165	60.6	391.8	69,900	147,900								165
170	58.8	388.7	65,900	142,000								170
175	57.0	385.4	62,200	136,400								175
180	55.2	381.9	58,700	131,200								180
185	53.4	378.1	55,300	126,200								185
190	51.5	374.1	52,200	121,500	58.3	381.6	33,200	107,400				190
195	49.5	369.8	49,100	117,100	56.5	378.3	30,700	103,300				195
200	47.5	365.2	46,300	112,900	54.7	374.7	28,300	99,400				200
205	45.4	360.2	43,500	108,900	52.8	370.8	26,100	95,800				205
210	43.3	354.8	40,900	105,000	50.9	366.7	23,900	92,300				210
215	41.0	349.0	38,400	101,400	48.9	362.3	21,900	89,000				215
220	38.6	342.8	36,000	97,900	46.9	357.6		85,800	53.9	365.4	74,000	220
225	36.1	335.9	33,700	94,600	44.8	352.5		82,700	52.0	361.4	71,300	225
230	33.4	328.3	31,500	91,400	42.6	347.0		79,800	50.1	357.2	68,600	230
235	30.5	319.9	29,300	88,300	40.3	341.1		77,000	48.1	352.7	66,100	235
240	27.3	310.3	27,200	85,300	37.9	334.7		74,400	46.0	347.8	63,700	240
245	23.7	299.2	25,100	82,500	35.3	327.6		71,800	43.9	342.6	61,300	245
250	19.4	285.6	23,100	79,700	32.6	319.8		69,300	41.7	336.9	59,100	250
255	13.8	267.4	21,000	76,900	29.6	311.1		66,900	39.3	330.8	56,900	255
260					26.3	301.1		64,600	36.8	324.1	54,800	260
265					22.5	289.4		62,300	34.2	316.7	52,800	265
270					18.0	274.8		60,100	31.4	308.6	50,900	270
275					11.6	253.9		57,900	28.3	299.4	49,000	275
280									24.8	288.7	47,100	280
290									15.7	259.6	43,500	290

# MLC650 VPC-MAX S-1

ASME B30.5

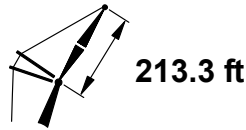
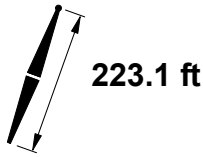

ft	85°				83°				80°				ft
	ft	lb	lb	lb	ft	lb	lb	lb	ft	lb	lb	lb	
90	74.2	436.7	266,800	289,900									90
95	72.8	435.1	248,600	289,900									95
100	71.4	433.4	232,300	289,500									100
105	69.9	431.5	217,600	288,900	72.2	433.5	202,400	286,800					105
110	68.5	429.5	204,300	287,900	70.7	431.7	189,800	286,800					110
115	67.0	427.4	192,200	283,500	69.3	429.7	178,400	273,200					115
120	65.5	425.0	181,100	269,000	67.8	427.6	168,000	259,100					120
125	64.0	422.6	171,000	255,700	66.4	425.4	158,400	246,200	69.7	428.4	139,600	232,200	125
130	62.5	419.9	161,700	243,400	64.9	423.0	149,500	234,400	68.3	426.4	131,500	220,900	130
135	61.0	417.1	153,000	232,200	63.4	420.5	141,400	223,500	66.8	424.2	124,100	210,500	135
140	59.4	414.1	145,000	221,700	61.8	417.7	133,800	213,400	65.3	421.9	117,200	200,900	140
145	57.8	410.9	137,600	212,000	60.3	414.8	126,800	204,000	63.8	419.4	110,700	192,000	145
150	56.2	407.5	130,700	203,000	58.7	411.7	120,300	195,200	62.3	416.7	104,800	183,700	150
155	54.5	403.9	124,200	194,600	57.1	408.5	114,100	187,100	60.8	413.9	99,200	175,900	155
160	52.9	400.0	118,100	186,700	55.5	405.0	108,400	179,500	59.2	410.8	93,900	168,600	160
165	51.1	396.0	112,400	179,400	53.8	401.3	103,000	172,300	57.6	407.6	89,000	161,800	165
170	49.3	391.6	107,000	172,400	52.1	397.3	97,900	165,600	56.0	404.2	84,400	155,500	170
175	47.5	387.0	102,000	165,900	50.3	393.1	93,200	159,300	54.3	400.5	80,000	149,400	175
180	45.6	382.1	97,200	159,800	48.5	388.7	88,600	153,300	52.6	396.7	75,900	143,800	180
185	43.7	376.8	92,700	153,900	46.7	383.9	84,400	147,700	50.9	392.6	72,000	138,400	185
190	41.6	371.1	88,400	148,400	44.8	378.8	80,300	142,400	49.1	388.2	68,300	133,400	190
195	39.5	365.0	84,300	143,200	42.8	373.4	76,500	137,300	47.3	383.5	64,800	128,500	195
200	37.3	358.5	80,400	138,300	40.7	367.5	72,800	132,500	45.4	378.5	61,400	124,000	200
205	35.0	351.3	76,700	133,500	38.5	361.2	69,300	128,000	43.4	373.2	58,200	119,600	205
210	32.5	343.5	73,100	129,000	36.3	354.4	65,900	123,600	41.4	367.5	55,200	115,500	210
215	29.8	334.8	69,700	124,800	33.9	346.9	62,700	119,500	39.2	361.3	52,300	111,600	215
220	26.8	325.0	66,400	120,600	31.3	338.7	59,700	115,500	37.0	354.7	49,500	107,800	220
225	23.5	313.8	63,300	116,700	28.5	329.6	56,700	111,700	34.6	347.4	46,800	104,200	225
230	19.7	300.3	60,200	112,900	25.4	319.2	53,800	108,100	32.1	339.5	44,200	100,800	230
235	14.8	282.9	57,100	109,300	21.9	307.1	51,000	104,600	29.4	330.7	41,700	97,400	235
240	6.7	253.2	53,800	105,600	17.6	292.2	48,300	101,200	26.4	320.7	39,300	94,300	240
245					11.9	271.6	45,500	97,800	23.0	309.2	36,900	91,200	245
250									19.1	295.4	34,600	88,200	250
255									14.0	277.1	32,300	85,300	255
260									4.2	241.1	29,600	82,300	260
265													265
270													270
275													275
280													280
290													290
300													300
310													310

# MLC650 VPC-MAX S-1

ASME B30.5

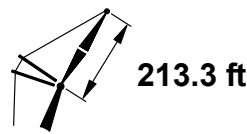
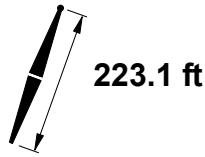

ft	75°				70°			65°			ft
	°	ft	lb	lb	ft	lb	ft	lb	ft	lb	
90											90
95											95
100											100
105											105
110											110
115											115
120											120
125											125
130											130
135											135
140											140
145											145
150											150
155											155
160											160
165	63.5	414.3	66,000	144,600							165
170	62.0	411.6	62,000	138,800							170
175	60.5	408.8	58,400	133,300							175
180	58.9	405.7	54,900	128,100							180
185	57.3	402.4	51,600	123,200							185
190	55.6	399.0	48,500	118,500							190
195	54.0	395.3	45,500	114,100	60.0	401.7	100,000				195
200	52.3	391.4	42,700	109,900	58.4	398.6	96,200				200
205	50.5	387.2	40,000	106,000	56.8	395.3	92,600				205
210	48.7	382.8	37,400	102,200	55.2	391.8	89,100				210
215	46.9	378.0	35,000	98,600	53.5	388.0	85,900				215
220	45.0	373.0	32,600	95,100	51.8	384.0	82,700				220
225	43.0	367.6	30,400	91,800	50.0	379.8	79,700				225
230	40.9	361.8	28,200	88,700	48.2	375.3	76,800	54.5	382.5	65,400	230
235	38.8	355.5	26,100	85,700	46.3	370.4	74,100	52.8	378.7	62,900	235
240	36.5	348.8	24,100	82,800	44.4	365.3	71,500	51.0	374.6	60,500	240
245	34.1	341.4	22,200	80,000	42.4	359.8	68,900	49.2	370.2	58,200	245
250	31.6	333.3	20,300	77,300	40.3	353.9	66,500	47.4	365.6	56,000	250
255	28.8	324.3		74,700	38.1	347.5	64,200	45.5	360.6	53,900	255
260	25.7	314.0		72,200	35.8	340.5	61,900	43.6	355.3	51,900	260
265	22.3	302.2		69,800	33.4	332.9	59,700	41.5	349.6	49,900	265
270	18.2	287.7		67,400	30.8	324.6	57,600	39.4	343.5	48,000	270
275	12.7	267.9		65,000	27.9	315.3	55,600	37.2	336.9	46,200	275
280					24.8	304.6	53,600	34.8	329.7	44,400	280
290					16.7	276.5	49,700	29.6	313.1	41,000	290
300								23.3	291.9	37,700	300
310								14.5	260.6	34,600	310

# MLC650 VPC-MAX S-1

ASME B30.5



440,900 lb



360°

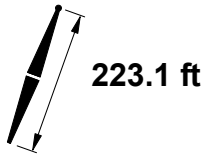

223.1 ft

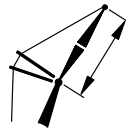

232.9 ft

ft	85°				83°				80°				ft
	ft	lb	lb	lb	ft	lb	lb	lb	ft	lb	lb	lb	
95	74.3	455.8	242,900	263,900									95
100	73.0	454.2	226,700	263,600									100
105	71.7	452.5	212,000	263,200									105
110	70.4	450.7	198,800	262,600	72.4	452.5	183,900	260,200					110
115	69.1	448.7	186,700	261,800	71.1	450.8	172,500	260,200					115
120	67.8	446.7	175,700	260,800	69.8	448.9	162,100	254,100					120
125	66.4	444.4	165,600	251,000	68.5	446.9	152,600	241,300					125
130	65.0	442.1	156,300	238,900	67.1	444.7	143,800	229,500					130
135	63.7	439.5	147,700	227,700	65.8	442.5	135,700	218,700	68.9	445.6	117,800	205,400	135
140	62.3	436.9	139,800	217,300	64.4	440.0	128,200	208,700	67.6	443.5	111,000	195,800	140
145	60.9	434.0	132,400	207,700	63.0	437.4	121,200	199,400	66.2	441.3	104,600	187,000	145
150	59.4	431.0	125,500	198,700	61.6	434.7	114,700	190,700	64.9	438.9	98,700	178,700	150
155	58.0	427.9	119,100	190,300	60.2	431.8	108,700	182,600	63.5	436.4	93,200	171,100	155
160	56.5	424.5	113,000	182,500	58.8	428.7	103,000	175,000	62.1	433.7	88,000	163,900	160
165	55.0	421.0	107,400	175,200	57.3	425.4	97,600	167,900	60.7	430.8	83,100	157,100	165
170	53.4	417.2	102,000	168,300	55.8	422.0	92,600	161,300	59.2	427.8	78,600	150,800	170
175	51.9	413.2	97,000	161,800	54.3	418.4	87,900	155,000	57.8	424.6	74,300	144,800	175
180	50.3	409.0	92,300	155,700	52.7	414.5	83,400	149,100	56.3	421.2	70,200	139,200	180
185	48.6	404.6	87,800	149,900	51.2	410.5	79,200	143,500	54.8	417.6	66,300	133,900	185
190	46.9	399.9	83,500	144,500	49.5	406.1	75,200	138,200	53.2	413.8	62,700	128,900	190
195	45.2	394.9	79,500	139,300	47.9	401.6	71,400	133,200	51.7	409.8	59,200	124,100	195
200	43.4	389.5	75,600	134,400	46.2	396.7	67,700	128,500	50.0	405.6	55,900	119,600	200
205	41.5	383.9	72,000	129,700	44.4	391.6	64,300	123,900	48.4	401.1	52,800	115,300	205
210	39.6	377.8	68,500	125,300	42.6	386.1	61,000	119,600	46.7	396.4	49,800	111,200	210
215	37.6	371.3	65,200	121,000	40.7	380.3	57,800	115,500	44.9	391.3	46,900	107,300	215
220	35.5	364.3	62,000	117,000	38.7	374.0	54,800	111,600	43.1	386.0	44,200	103,600	220
225	33.2	356.6	58,900	113,100	36.6	367.3	52,000	107,900	41.3	380.2	41,600	100,100	225
230	30.8	348.3	55,900	109,400	34.5	360.0	49,200	104,300	39.3	374.1	39,100	96,700	230
235	28.2	339.0	53,100	105,800	32.2	352.0	46,500	100,800	37.3	367.5	36,700	93,400	235
240	25.4	328.7	50,300	102,400	29.7	343.3	43,900	97,500	35.2	360.4	34,300	90,300	240
245	22.2	316.7	47,700	99,100	27.0	333.6	41,400	94,400	32.9	352.7	32,100	87,300	245
250	18.5	302.4	45,000	95,900	24.0	322.6	39,000	91,300	30.5	344.2	29,900	84,400	250
255	13.8	283.8	42,400	92,800	20.6	309.7	36,700	88,300	27.9	334.9	27,800	81,600	255
260	5.4	250.3	39,600	89,700	16.5	293.9	34,300	85,500	25.0	324.3	25,700	78,900	260
265					10.9	271.6	31,900	82,600	21.7	312.1	23,700	76,300	265
270									17.9	297.4	21,700	73,800	270
275									13.0	277.8		71,300	275
280													280
290													290
300													300
310													310
320													320
330													330

# MLC650 VPC-MAX S-1

ASME B30.5

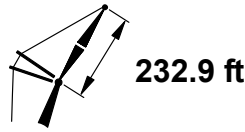
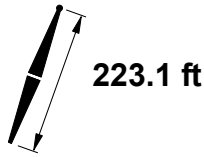

ft	75°				70°			65°			ft
	°	ft	lb	lb	°	ft	lb	°	ft	lb	
95											95
100											100
105											105
110											110
115											115
120											120
125											125
130											130
135											135
140											140
145											145
150											150
155											155
160											160
165											165
170	64.6	433.9	55,500	133,600							170
175	63.2	431.3	51,800	128,200							175
180	61.8	428.6	48,400	123,000							180
185	60.4	425.7	45,200	118,200							185
190	58.9	422.7	42,100	113,600							190
195	57.5	419.4	39,200	109,200							195
200	56.0	416.0	36,500	105,100							200
205	54.5	412.4	33,800	101,200	60.0	418.7	87,400				205
210	52.9	408.6	31,300	97,400	58.5	415.6	84,000				210
215	51.3	404.5	28,900	93,900	57.0	412.3	80,700				215
220	49.7	400.2	26,700	90,500	55.5	408.8	77,700				220
225	48.1	395.7	24,500	87,200	54.0	405.1	74,700				225
230	46.3	390.9	22,400	84,100	52.4	401.3	71,900				230
235	44.6	385.8	20,300	81,200	50.9	397.1	69,200				235
240	42.8	380.3		78,300	49.2	392.8	66,600	54.9	399.6	55,300	240
245	40.9	374.5		75,600	47.6	388.2	64,100	53.4	395.8	53,000	245
250	38.9	368.3		73,000	45.8	383.3	61,800	51.8	391.8	50,900	250
255	36.9	361.6		70,400	44.1	378.1	59,500	50.2	387.6	48,800	255
260	34.7	354.4		68,000	42.2	372.5	57,300	48.5	383.2	46,800	260
265	32.4	346.5		65,600	40.3	366.6	55,100	46.8	378.4	44,900	265
270	30.0	337.9		63,400	38.3	360.3	53,100	45.1	373.4	43,100	270
275	27.3	328.3		61,100	36.2	353.4	51,100	43.3	368.1	41,300	275
280	24.4	317.5		59,000	34.0	346.0	49,200	41.4	362.4	39,600	280
290	17.0	289.4		54,900	29.2	329.1	45,500	37.5	349.8	36,300	290
300					23.4	307.8	42,000	33.1	335.0	33,200	300
310					15.7	277.9	38,700	28.1	317.4	30,300	310
320								22.0	294.9	27,500	320
330								13.5	261.5	24,700	330

# MLC650 VPC-MAX S-1

ASME B30.5

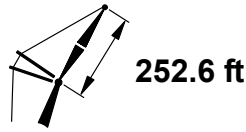
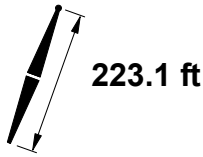

ft	85°				83°				80°				ft
	ft	lb	lb	lb	ft	lb	lb	lb	ft	lb	lb	lb	
100	74.4	474.8	223,200	227,400									100
105	73.2	473.3	208,600	227,000									105
110	72.0	471.6	195,400	226,600									110
115	70.8	469.8	183,400	225,900	72.7	471.6	168,800	223,700					115
120	69.6	467.9	172,400	225,200	71.5	469.9	158,500	223,700					120
125	68.4	465.9	162,300	224,300	70.2	468.1	149,000	223,700					125
130	67.1	463.8	153,000	223,300	69.0	466.1	140,300	223,500					130
135	65.9	461.5	144,500	222,300	67.8	464.0	132,200	215,500					135
140	64.6	459.1	136,500	214,300	66.6	461.8	124,700	205,500	69.4	464.8	107,100	192,500	140
145	63.3	456.5	129,200	204,700	65.3	459.5	117,800	196,300	68.2	462.8	100,800	183,700	145
150	62.1	453.8	122,300	195,800	64.0	457.0	111,300	187,700	66.9	460.6	94,900	175,500	150
155	60.8	451.0	115,900	187,500	62.8	454.4	105,300	179,600	65.7	458.3	89,400	167,900	155
160	59.4	448.0	109,900	179,700	61.5	451.6	99,600	172,100	64.4	455.9	84,300	160,700	160
165	58.1	444.8	104,200	172,400	60.2	448.7	94,300	165,000	63.2	453.3	79,500	154,000	165
170	56.7	441.5	98,900	165,600	58.8	445.7	89,300	158,400	61.9	450.6	74,900	147,800	170
175	55.3	438.0	93,900	159,100	57.5	442.4	84,600	152,200	60.6	447.8	70,700	141,800	175
180	53.9	434.3	89,200	153,100	56.1	439.0	80,100	146,300	59.2	444.7	66,600	136,300	180
185	52.5	430.5	84,700	147,300	54.7	435.5	75,900	140,800	57.9	441.6	62,800	131,000	185
190	51.0	426.4	80,500	141,900	53.3	431.7	71,900	135,500	56.5	438.2	59,200	126,000	190
195	49.5	422.1	76,500	136,700	51.8	427.7	68,200	130,500	55.2	434.7	55,800	121,300	195
200	48.0	417.5	72,700	131,800	50.4	423.5	64,600	125,800	53.7	431.0	52,500	116,800	200
205	46.4	412.7	69,100	127,200	48.9	419.1	61,200	121,300	52.3	427.1	49,400	112,500	205
210	44.8	407.7	65,600	122,800	47.3	414.5	57,900	117,000	50.8	423.0	46,400	108,500	210
215	43.2	402.3	62,300	118,600	45.7	409.6	54,800	113,000	49.3	418.6	43,600	104,600	215
220	41.4	396.6	59,100	114,500	44.1	404.4	51,800	109,100	47.8	414.1	40,900	100,900	220
225	39.7	390.6	56,100	110,700	42.4	398.9	49,000	105,400	46.2	409.2	38,300	97,400	225
230	37.8	384.1	53,200	107,000	40.7	393.0	46,200	101,800	44.6	404.1	35,800	94,000	230
235	35.9	377.2	50,400	103,500	38.8	386.8	43,600	98,400	42.9	398.7	33,500	90,800	235
240	33.8	369.7	47,700	100,100	36.9	380.1	41,100	95,100	41.2	393.0	31,200	87,700	240
245	31.7	361.6	45,200	96,900	35.0	373.0	38,700	92,000	39.4	386.9	29,000	84,700	245
250	29.4	352.8	42,700	93,700	32.9	365.2	36,300	89,000	37.5	380.3	26,900	81,900	250
255	26.9	343.0	40,200	90,700	30.7	356.8	34,100	86,100	35.6	373.3	24,800	79,100	255
260	24.2	332.1	37,900	87,800	28.3	347.6	31,900	83,300	33.5	365.8	22,900	76,500	260
265	21.1	319.5	35,600	85,000	25.7	337.4	29,800	80,600	31.4	357.6	20,900	73,900	265
270	17.5	304.3	33,300	82,300	22.8	325.7	27,700	78,000	29.0	348.7		71,500	270
275	12.8	284.4	31,100	79,600	19.5	312.1	25,600	75,400	26.5	338.8		69,100	275
280	4.0	246.0	28,500	74,000	15.6	295.3	23,600	73,000	23.8	327.6		66,800	280
290									16.9	299.1		62,300	290
300													300
310													310
320													320
330													330

# MLC650 VPC-MAX S-1

ASME B30.5

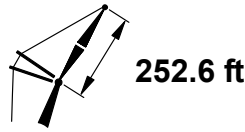
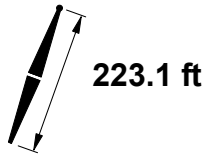

ft	75°				70°			65°			ft
	°	ft	lb	lb	ft	lb	ft	lb	ft		
100										100	
105										105	
110										110	
115										115	
120										120	
125										125	
130										130	
135										135	
140										140	
145										145	
150										150	
155										155	
160										160	
165										165	
170										170	
175										175	
180	64.2	450.9	44,400	119,800						180	
185	62.9	448.3	41,200	114,900						185	
190	61.6	445.6	38,200	110,400						190	
195	60.3	442.7	35,300	106,100						195	
200	59.0	439.6	32,600	102,000						200	
205	57.6	436.4	30,000	98,100						205	
210	56.3	433.0	27,500	94,400						210	
215	54.9	429.5	25,200	90,900	59.9	435.6	77,500			215	
220	53.4	425.7	22,900	87,500	58.6	432.6	74,400			220	
225	52.0	421.8	20,800	84,300	57.2	429.3	71,500			225	
230	50.5	417.6		81,200	55.9	425.9	68,700			230	
235	49.0	413.2		78,300	54.5	422.2	66,100			235	
240	47.5	408.6		75,500	53.0	418.4	63,500			240	
245	45.9	403.7		72,800	51.6	414.4	61,100			245	
250	44.3	398.6		70,200	50.1	410.2	58,700			250	
255	42.6	393.1		67,700	48.6	405.8	56,500	53.9	413.0	45,600	255
260	40.8	387.3		65,300	47.0	401.1	54,300	52.4	409.1	43,600	260
265	39.0	381.1		63,000	45.4	396.1	52,200	51.0	405.0	41,800	265
270	37.2	374.5		60,700	43.8	390.8	50,200	49.5	400.7	40,000	270
275	35.2	367.4		58,600	42.1	385.3	48,200	47.9	396.1	38,200	275
280	33.1	359.7		56,500	40.3	379.4	46,300	46.4	391.3	36,500	280
290	28.6	342.3		52,500	36.6	366.3	42,800	43.1	380.8	33,300	290
300	23.2	320.7		48,700	32.5	351.2	39,400	39.6	369.1	30,300	300
310	16.0	290.9		45,200	27.8	333.3	36,200	35.8	355.6	27,400	310
320					22.3	310.8	33,200	31.6	340.0	24,800	320
330					14.7	279.0	30,300	26.8	321.3	22,200	330

# MLC650 VPC-MAX S-1

ASME B30.5

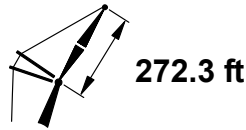
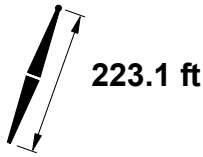

ft	85°				83°				80°				ft
	ft	lb	lb	lb	ft	lb	lb	lb	ft	lb	lb	lb	
105	74.4	493.9	197,800	197,800									105
110	73.3	492.4	193,100	196,900									110
115	72.2	490.7	181,100	196,400									115
120	71.1	489.0	170,200	195,700	72.8	490.7	156,000	194,100					120
125	70.0	487.1	160,100	195,000	71.7	489.0	146,600	194,100					125
130	68.9	485.1	150,900	194,200	70.6	487.2	137,900	193,900					130
135	67.7	483.1	142,400	193,300	69.5	485.3	129,900	193,600					135
140	66.6	480.9	134,500	192,400	68.4	483.3	122,400	193,300					140
145	65.4	478.5	127,100	191,300	67.2	481.2	115,500	192,800	69.8	484.0	98,200	181,300	145
150	64.2	476.1	120,300	190,300	66.1	478.9	109,100	185,500	68.7	482.0	92,400	173,200	150
155	63.1	473.5	113,900	185,600	64.9	476.5	103,100	177,500	67.6	479.9	86,900	165,600	155
160	61.9	470.8	107,900	177,800	63.7	474.0	97,400	170,100	66.4	477.7	81,800	158,500	160
165	60.7	467.9	102,300	170,600	62.5	471.4	92,100	163,100	65.3	475.4	77,000	151,900	165
170	59.4	464.9	97,000	163,800	61.3	468.6	87,200	156,500	64.1	472.9	72,500	145,600	170
175	58.2	461.8	92,000	157,400	60.1	465.7	82,500	150,300	62.9	470.3	68,300	139,800	175
180	56.9	458.5	87,300	151,300	58.9	462.6	78,100	144,400	61.7	467.6	64,300	134,200	180
185	55.7	455.1	82,900	145,600	57.6	459.4	73,900	138,900	60.5	464.7	60,500	129,000	185
190	54.4	451.4	78,700	140,200	56.4	456.1	69,900	133,700	59.3	461.7	56,900	124,000	190
195	53.0	447.6	74,700	135,100	55.1	452.5	66,200	128,800	58.0	458.5	53,500	119,400	195
200	51.7	443.6	70,900	130,200	53.8	448.8	62,600	124,100	56.8	455.2	50,300	114,900	200
205	50.3	439.5	67,300	125,600	52.4	444.9	59,200	119,600	55.5	451.7	47,200	110,700	205
210	48.9	435.1	63,900	121,200	51.1	440.9	56,000	115,400	54.2	448.1	44,300	106,600	210
215	47.5	430.4	60,600	117,000	49.7	436.6	52,900	111,300	52.8	444.3	41,500	102,800	215
220	46.0	425.6	57,500	113,000	48.3	432.1	50,000	107,400	51.5	440.3	38,800	99,100	220
225	44.5	420.5	54,500	109,200	46.8	427.4	47,200	103,800	50.1	436.0	36,300	95,600	225
230	43.0	415.1	51,600	105,500	45.3	422.4	44,500	100,200	48.7	431.6	33,800	92,300	230
235	41.4	409.4	48,800	102,100	43.8	417.1	41,900	96,900	47.3	427.0	31,500	89,100	235
240	39.7	403.3	46,200	98,700	42.2	411.6	39,400	93,600	45.8	422.1	29,200	86,000	240
245	38.0	396.9	43,700	95,500	40.6	405.8	37,000	90,500	44.3	416.9	27,100	83,100	245
250	36.2	390.1	41,200	92,400	39.0	399.5	34,700	87,500	42.7	411.5	25,000	80,300	250
255	34.4	382.7	38,900	89,400	37.2	392.9	32,500	84,700	41.1	405.7	23,000	77,600	255
260	32.4	374.9	36,600	86,600	35.4	385.9	30,400	81,900	39.5	399.6	21,100	74,900	260
265	30.3	366.4	34,400	83,800	33.5	378.4	28,300	79,200	37.8	393.2		72,400	265
270	28.1	357.1	32,300	81,200	31.5	370.2	26,300	76,700	36.0	386.3		70,000	270
275	25.7	346.8	30,200	78,600	29.3	361.4	24,400	74,200	34.1	378.9		67,700	275
280	23.0	335.3	28,200	76,100	27.0	351.7	22,500	71,800	32.1	370.9		65,400	280
290	16.5	306.0	24,200	71,300	21.8	328.6		67,200	27.8	352.9		61,100	290
300	1.8	236.7		59,100	14.7	296.5		62,900	22.7	330.7		57,000	300
310									16.0	300.6		53,200	310
320													320
330													330
340													340
350													350



# MLC650 VPC-MAX S-1

ASME B30.5

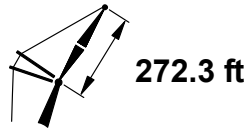
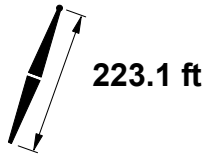

ft	75°				70°			65°			ft
	°	ft	lb	lb	°	ft	lb	°	ft	lb	
105											105
110											110
115											115
120											120
125											125
130											130
135											135
140											140
145											145
150											150
155											155
160											160
165											165
170											170
175											175
180											180
185											185
190	63.8	467.9	35,500	108,200							190
195	62.7	465.3	32,700	103,900							195
200	61.5	462.5	30,000	99,800							200
205	60.2	459.6	27,400	96,000							205
210	59.0	456.6	25,000	92,300							210
215	57.8	453.4	22,700	88,800							215
220	56.5	450.0	20,500	85,500							220
225	55.2	446.5		82,300	59.9	452.6	69,300				225
230	53.9	442.8		79,300	58.6	449.5	66,600				230
235	52.6	439.0		76,400	57.4	446.3	63,900				235
240	51.2	434.9		73,600	56.1	442.9	61,400				240
245	49.8	430.7		70,900	54.8	439.3	59,000				245
250	48.4	426.2		68,300	53.5	435.6	56,700				250
255	47.0	421.5		65,900	52.2	431.7	54,400				255
260	45.5	416.5		63,500	50.8	427.6	52,300				260
265	44.0	411.3		61,200	49.4	423.2	50,200	54.3	430.1	39,600	265
270	42.4	405.8		59,000	48.0	418.7	48,200	53.0	426.3	37,800	270
275	40.8	400.0		56,900	46.6	413.9	46,300	51.6	422.3	36,100	275
280	39.1	393.9		54,800	45.1	408.9	44,500	50.2	418.1	34,400	280
290	35.6	380.3		50,900	42.0	398.0	40,900	47.4	409.0	31,300	290
300	31.7	364.7		47,300	38.6	385.8	37,600	44.4	399.0	28,300	300
310	27.3	346.4		43,800	35.0	372.0	34,500	41.3	387.9	25,500	310
320	22.1	323.6		40,500	31.1	356.1	31,600	37.9	375.4	22,900	320
330	15.1	292.2		37,400	26.6	337.2	28,800	34.3	361.2	20,500	330
340					21.2	313.6	26,200				340
350					13.8	280.0	23,600				350

# MLC650 VPC-MAX S-1

ASME B30.5



440,900 lb

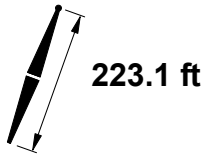

223.1 ft



292.0 ft

ft	85°				83°				80°				ft
	ft	lb	lb	lb	ft	lb	lb	lb	ft	lb	lb	lb	
110	74.5	512.9	184,300	184,300									110
115	73.5	511.4	173,000	183,800									115
120	72.4	509.8	162,100	183,100									120
125	71.4	508.1	152,200	182,400									125
130	70.4	506.3	143,000	181,700	72.0	508.1	129,400	180,900					130
135	69.3	504.3	134,500	180,900	70.9	506.3	121,400	180,600					135
140	68.3	502.3	126,600	180,000	69.9	504.5	114,100	180,200					140
145	67.2	500.2	119,300	179,000	68.8	502.5	107,200	179,800					145
150	66.1	497.9	112,500	178,000	67.8	500.4	100,800	179,000					150
155	65.0	495.6	106,100	177,000	66.7	498.2	94,900	171,100	69.2	501.2	78,000	158,700	155
160	63.9	493.1	100,200	171,800	65.6	495.9	89,300	163,700	68.1	499.2	73,000	151,700	160
165	62.8	490.5	94,600	164,600	64.5	493.5	84,000	156,700	67.0	497.0	68,300	145,100	165
170	61.7	487.7	89,400	157,800	63.4	491.0	79,100	150,200	66.0	494.8	63,800	138,900	170
175	60.6	484.9	84,400	151,400	62.3	488.3	74,500	144,100	64.9	492.4	59,700	133,100	175
180	59.4	481.9	79,700	145,400	61.2	485.6	70,100	138,300	63.8	489.9	55,700	127,600	180
185	58.3	478.8	75,300	139,700	60.1	482.6	66,000	132,800	62.7	487.3	52,000	122,400	185
190	57.1	475.5	71,200	134,400	58.9	479.6	62,000	127,600	61.6	484.5	48,400	117,500	190
195	55.9	472.1	67,200	129,300	57.8	476.4	58,300	122,700	60.4	481.7	45,100	112,900	195
200	54.7	468.5	63,400	124,400	56.6	473.1	54,800	118,000	59.3	478.7	41,900	108,500	200
205	53.5	464.8	59,900	119,800	55.4	469.6	51,400	113,600	58.1	475.5	38,900	104,300	205
210	52.2	460.9	56,400	115,500	54.2	465.9	48,200	109,400	56.9	472.2	36,000	100,300	210
215	51.0	456.8	53,200	111,300	52.9	462.1	45,200	105,400	55.8	468.8	33,200	96,500	215
220	49.7	452.5	50,100	107,300	51.7	458.1	42,300	101,500	54.5	465.2	30,600	92,900	220
225	48.4	448.0	47,100	103,500	50.4	454.0	39,500	97,900	53.3	461.4	28,100	89,400	225
230	47.0	443.3	44,300	99,900	49.1	449.6	36,800	94,400	52.1	457.5	25,700	86,100	230
235	45.6	438.4	41,600	96,400	47.8	445.0	34,300	91,000	50.8	453.4	23,400	82,900	235
240	44.2	433.2	39,000	93,100	46.4	440.2	31,800	87,800	49.5	449.1	21,200	79,900	240
245	42.8	427.8	36,500	89,900	45.0	435.2	29,500	84,700	48.2	444.6		77,000	245
250	41.3	422.1	34,000	86,900	43.6	429.9	27,200	81,800	46.8	439.8		74,200	250
255	39.8	416.1	31,700	83,900	42.1	424.4	25,000	78,900	45.5	434.9		71,500	255
260	38.2	409.7	29,500	81,100	40.6	418.5	22,900	76,200	44.0	429.7		68,900	260
265	36.5	402.9	27,300	78,400	39.1	412.3	20,900	73,600	42.6	424.2		66,500	265
270	34.8	395.7	25,200	75,700	37.4	405.8		71,000	41.1	418.5		64,100	270
275	33.0	388.0	23,200	73,200	35.8	398.8		68,600	39.5	412.4		61,700	275
280	31.1	379.8	21,300	70,700	34.0	391.4		66,200	37.9	406.0		59,500	280
290	26.9	361.1		66,100	30.2	374.9		61,700	34.6	391.9		55,300	290
300	22.0	338.2		61,700	25.9	355.5		57,500	30.8	375.8		51,300	300
310	15.7	307.4		57,500	20.8	331.3		53,600	26.6	356.8		47,600	310
320					13.9	297.4		49,800	21.7	333.6		44,000	320
330									15.2	301.9		40,600	330
340													340
350													350

# MLC650 VPC-MAX S-1

ASME B30.5

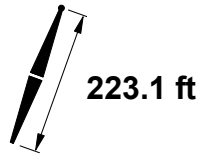

ft	75°			70°			ft
	ft	ft	lb	ft	ft	lb	
110							110
115							115
120							120
125							125
130							130
135							135
140							140
145							145
150							150
155							155
160							160
165							165
170							170
175							175
180							180
185							185
190							190
195	64.7	487.4	96,800				195
200	63.6	484.9	92,800				200
205	62.4	482.2	89,000				205
210	61.3	479.5	85,400				210
215	60.2	476.6	82,000				215
220	59.0	473.5	78,700				220
225	57.9	470.4	75,500				225
230	56.7	467.0	72,500				230
235	55.5	463.6	69,700	59.9	469.6	56,700	235
240	54.3	459.9	66,900	58.7	466.5	54,200	240
245	53.1	456.1	64,300	57.5	463.3	51,900	245
250	51.8	452.2	61,800	56.4	459.9	49,600	250
255	50.5	448.0	59,300	55.2	456.4	47,400	255
260	49.2	443.7	57,000	53.9	452.7	45,300	260
265	47.9	439.1	54,700	52.7	448.9	43,300	265
270	46.6	434.4	52,600	51.4	444.8	41,300	270
275	45.2	429.4	50,500	50.2	440.6	39,500	275
280	43.7	424.1	48,500	48.8	436.2	37,600	280
290	40.8	412.8	44,600	46.2	426.8	34,200	290
300	37.6	400.1	41,000	43.3	416.4	31,000	300
310	34.2	385.8	37,700	40.3	404.8	28,000	310
320	30.4	369.5	34,500	37.1	392.0	25,100	320
330	26.2	350.2	31,500	33.7	377.4	22,400	330
340	21.1	326.4	28,600				340
350	14.3	293.3	25,800				350

# MLC650 VPC-MAX S-1

ASME B30.5



440,900 lb

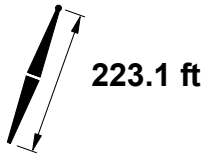

223.1 ft



311.7 ft

ft	85°				83°				80°				ft
	ft	lb	lb	lb	ft	lb	lb	lb	ft	lb	lb	lb	
115	74.6	532.0	159,900	159,900									115
120	73.6	530.5	159,400	159,400									120
125	72.6	528.9	150,200	158,800									125
130	71.7	527.2	141,100	158,100									130
135	70.7	525.4	132,600	157,300	72.2	527.2	119,300	156,600					135
140	69.7	523.5	124,700	156,500	71.2	525.5	112,000	156,200					140
145	68.7	521.5	117,400	155,700	70.2	523.6	105,100	155,800					145
150	67.7	519.5	110,700	155,000	69.3	521.7	98,800	155,300					150
155	66.7	517.3	104,300	153,900	68.3	519.7	92,800	154,700					155
160	65.7	515.0	98,400	153,100	67.3	517.6	87,300	154,100	69.6	520.4	70,700	149,600	160
165	64.7	512.6	92,800	152,100	66.3	515.3	82,000	153,600	68.6	518.4	66,000	143,100	165
170	63.7	510.1	87,600	151,100	65.2	513.0	77,100	148,400	67.6	516.3	61,600	136,900	170
175	62.6	507.4	82,600	149,800	64.2	510.5	72,500	142,300	66.6	514.1	57,400	131,200	175
180	61.6	504.7	78,000	143,800	63.2	508.0	68,200	136,500	65.6	511.8	53,500	125,700	180
185	60.5	501.8	73,600	138,100	62.1	505.3	64,000	131,100	64.5	509.4	49,800	120,600	185
190	59.4	498.9	69,400	132,800	61.1	502.5	60,100	125,900	63.5	506.9	46,300	115,700	190
195	58.4	495.7	65,500	127,700	60.0	499.6	56,400	121,000	62.5	504.3	43,000	111,100	195
200	57.3	492.5	61,700	122,900	59.0	496.5	52,900	116,400	61.4	501.5	39,800	106,700	200
205	56.1	489.1	58,200	118,300	57.9	493.4	49,600	112,000	60.4	498.6	36,800	102,500	205
210	55.0	485.6	54,800	114,000	56.8	490.1	46,400	107,800	59.3	495.6	33,900	98,600	210
215	53.9	481.9	51,500	109,800	55.6	486.6	43,400	103,800	58.2	492.5	31,200	94,800	215
220	52.7	478.1	48,500	105,900	54.5	483.0	40,500	100,000	57.1	489.2	28,600	91,200	220
225	51.5	474.1	45,500	102,100	53.4	479.3	37,700	96,300	56.0	485.8	26,100	87,800	225
230	50.3	469.9	42,700	98,500	52.2	475.3	35,100	92,900	54.9	482.3	23,700	84,500	230
235	49.1	465.5	40,000	95,000	51.0	471.3	32,500	89,500	53.7	478.5	21,500	81,300	235
240	47.9	461.0	37,400	91,700	49.8	467.0	30,100	86,300	52.6	474.7		78,300	240
245	46.6	456.2	34,900	88,600	48.6	462.6	27,800	83,300	51.4	470.7		75,400	245
250	45.3	451.2	32,500	85,500	47.3	457.9	25,500	80,300	50.2	466.5		72,600	250
255	44.0	446.0	30,200	82,600	46.0	453.1	23,400	77,500	49.0	462.1		70,000	255
260	42.6	440.6	28,000	79,800	44.7	448.0	21,300	74,800	47.7	457.5		67,400	260
265	41.2	434.8	25,800	77,100	43.4	442.7		72,200	46.4	452.7		64,900	265
270	39.8	428.8	23,800	74,400	42.0	437.1		69,700	45.1	447.7		62,600	270
275	38.3	422.5	21,800	71,900	40.6	431.2		67,200	43.8	442.5		60,300	275
280	36.8	415.8		69,500	39.1	425.1		64,900	42.4	437.0		58,100	280
290	33.5	401.1		64,900	36.1	411.7		60,500	39.6	425.1		53,900	290
300	29.9	384.4		60,600	32.7	396.6		56,300	36.6	412.0		49,900	300
310	25.9	364.9		56,500	29.1	379.4		52,400	33.3	397.2		46,200	310
320	21.1	341.0		52,700	24.9	359.0		48,700	29.7	380.4		42,800	320
330	14.9	308.7		49,000	19.9	333.8		45,200	25.6	360.6		39,500	330
340					13.1	298.2		41,800	20.8	336.3		36,400	340
350									14.4	303.1		33,400	350
360													360

# MLC650 VPC-MAX S-1

ASME B30.5

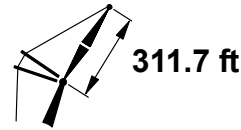
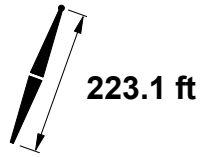

ft	75°			70°			ft
	ft	ft	lb	ft	lb	ft	
115							115
120							120
125							125
130							130
135							135
140							140
145							145
150							150
155							155
160							160
165							165
170							170
175							175
180							180
185							185
190							190
195							195
200							200
205	64.3	504.4	87,000				205
210	63.3	501.9	83,400				210
215	62.3	499.2	80,000				215
220	61.2	496.4	76,700				220
225	60.1	493.5	73,600				225
230	59.1	490.5	70,700				230
235	58.0	487.3	67,800				235
240	56.9	484.0	65,100				240
245	55.8	480.6	62,500	59.8	486.5	49,800	245
250	54.6	477.0	60,000	58.8	483.4	47,600	250
255	53.5	473.3	57,600	57.7	480.2	45,400	255
260	52.3	469.4	55,200	56.6	476.9	43,400	260
265	51.1	465.3	53,000	55.4	473.4	41,400	265
270	49.9	461.1	50,900	54.3	469.8	39,400	270
275	48.7	456.7	48,800	53.1	466.0	37,600	275
280	47.5	452.0	46,800	52.0	462.1	35,800	280
290	44.9	442.2	43,000	49.6	453.7	32,400	290
300	42.2	431.3	39,500	47.1	444.5	29,200	300
310	39.3	419.4	36,100	44.5	434.5	26,200	310
320	36.2	406.1	33,000	41.8	423.5	23,400	320
330	32.9	391.1	30,100	38.9	411.4	20,800	330
340	29.3	374.0	27,300				340
350	25.2	353.9	24,600				350
360	20.2	328.9	22,100				360

# MLC650 VPC-MAX S-1

ASME B30.5

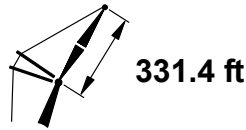
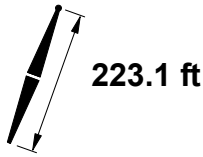

ft	85°				83°				80°				ft
	ft	lb	lb	lb	ft	lb	lb	lb	ft	lb	lb	lb	
120	74.6	551.0	138,100	138,100									120
125	73.7	549.5	137,500	137,500									125
130	72.8	547.9	136,800	136,800									130
135	71.9	546.3	129,200	136,100									135
140	71.0	544.5	121,300	135,300	72.4	546.3	108,300	134,600					140
145	70.0	542.7	114,100	134,600	71.5	544.6	101,500	134,200					145
150	69.1	540.7	107,300	133,700	70.5	542.8	95,200	133,700					150
155	68.2	538.7	101,000	132,900	69.6	540.9	89,300	133,100					155
160	67.2	536.6	95,000	132,000	68.7	538.9	83,700	132,500					160
165	66.3	534.3	89,500	131,100	67.8	536.8	78,500	131,900	69.9	539.6	62,200	128,400	165
170	65.3	532.0	84,200	130,200	66.8	534.7	73,600	131,200	69.0	537.6	57,800	128,200	170
175	64.4	529.6	79,300	129,400	65.9	532.4	69,000	130,600	68.0	535.6	53,700	128,000	175
180	63.4	527.1	74,700	128,400	64.9	530.0	64,700	129,900	67.1	533.5	49,800	122,700	180
185	62.4	524.4	70,300	127,500	63.9	527.5	60,600	128,200	66.2	531.2	46,100	117,500	185
190	61.4	521.7	66,200	126,600	63.0	525.0	56,700	123,100	65.2	528.9	42,600	112,700	190
195	60.4	518.8	62,200	125,000	62.0	522.3	53,000	118,200	64.2	526.4	39,300	108,100	195
200	59.4	515.8	58,500	120,200	61.0	519.5	49,500	113,600	63.3	523.9	36,200	103,700	200
205	58.4	512.7	54,900	115,700	60.0	516.5	46,200	109,200	62.3	521.2	33,200	99,600	205
210	57.4	509.5	51,500	111,300	59.0	513.5	43,000	105,000	61.3	518.5	30,300	95,700	210
215	56.4	506.1	48,300	107,200	58.0	510.3	40,000	101,100	60.3	515.6	27,600	91,900	215
220	55.3	502.6	45,200	103,300	56.9	507.1	37,100	97,300	59.3	512.6	25,000	88,300	220
225	54.2	499.0	42,300	99,500	55.9	503.6	34,400	93,600	58.3	509.4	22,600	84,900	225
230	53.1	495.2	39,500	95,900	54.8	500.1	31,700	90,200	57.2	506.2	20,200	81,600	230
235	52.0	491.3	36,800	92,500	53.7	496.4	29,200	86,900	56.2	502.8		78,500	235
240	50.9	487.2	34,200	89,200	52.7	492.5	26,800	83,700	55.2	499.3		75,500	240
245	49.8	482.9	31,700	86,000	51.5	488.5	24,500	80,600	54.1	495.7		72,600	245
250	48.6	478.5	29,300	83,000	50.4	484.4	22,200	77,700	53.0	491.9		69,900	250
255	47.5	473.9	27,100	80,100	49.3	480.0	20,100	74,900	51.9	487.9		67,200	255
260	46.3	469.1	24,900	77,300	48.1	475.5		72,200	50.8	483.8		64,700	260
265	45.0	464.1	22,700	74,600	46.9	470.8		69,600	49.6	479.5		62,200	265
270	43.8	458.8	20,700	72,000	45.7	465.9		67,100	48.5	475.1		59,900	270
275	42.5	453.3		69,500	44.5	460.8		64,700	47.3	470.4		57,600	275
280	41.2	447.6		67,000	43.2	455.4		62,400	46.1	465.6		55,400	280
290	38.4	435.3		62,500	40.6	444.0		57,900	43.6	455.2		51,200	290
300	35.5	421.6		58,200	37.8	431.4		53,800	41.0	443.9		47,300	300
310	32.4	406.3		54,100	34.8	417.4		50,000	38.2	431.5		43,700	310
320	28.9	388.9		50,400	31.6	401.7		46,300	35.3	417.8		40,300	320
330	25.0	368.5		46,800	28.0	383.7		42,900	32.1	402.3		37,000	330
340	20.3	343.6		43,400	24.0	362.4		39,600	28.6	384.7		34,000	340
350	14.2	309.8		40,200	19.1	336.1		36,500	24.7	364.1		31,100	350
360					12.4	298.7		33,500	19.9	338.8		28,300	360
370									13.7	304.0		25,600	370

# MLC650 VPC-MAX S-1

ASME B30.5

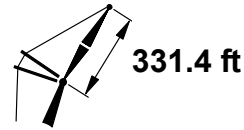
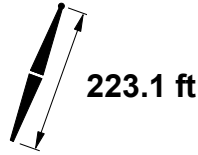

ft	75°			70°			ft
	ft	ft	lb	ft	lb	ft	
120							120
125							125
130							130
135							135
140							140
145							145
150							150
155							155
160							160
165							165
170							170
175							175
180							180
185							185
190							190
195							195
200							200
205							205
210							210
215	64.0	521.4	76,900				215
220	63.1	518.9	73,700				220
225	62.1	516.2	70,600				225
230	61.1	513.4	67,600				230
235	60.1	510.5	64,800				235
240	59.1	507.5	62,100				240
245	58.1	504.3	59,500				245
250	57.0	501.0	57,000				250
255	56.0	497.6	54,600	59.8	503.5	42,300	255
260	54.9	494.1	52,300	58.8	500.4	40,200	260
265	53.9	490.4	50,100	57.8	497.2	38,300	265
270	52.8	486.6	48,000	56.7	493.9	36,400	270
275	51.7	482.6	45,900	55.7	490.5	34,500	275
280	50.5	478.4	43,900	54.6	486.9	32,700	280
290	48.2	469.6	40,200	52.4	479.3	29,400	290
300	45.8	460.1	36,700	50.2	471.1	26,200	300
310	43.3	449.6	33,400	47.9	462.1	23,300	310
320	40.7	438.3	30,300	45.5	452.5	20,500	320
330	38.0	425.7	27,400				330
340	35.0	411.8	24,600				340
350	31.8	396.2	22,000				350
360							360
370							370

# MLC650 VPC-MAX S-1

ASME B30.5

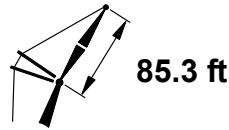
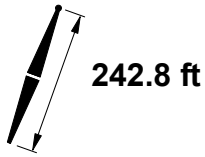

ft	85°				83°				80°				ft
	ft	lb	lb	lb	ft	lb	lb	lb	ft	lb	lb	lb	
60	72.0	332.1	396,500 d	653,900 d									60
65	68.3	330.0	359,900 c	596,500 c									65
70	64.6	327.5	328,900 c	545,700 c	70.9	330.5	306,500 c	528,100 c					70
75	60.7	324.6	302,200 b	502,400 b	67.2	328.3	281,600 c	486,200 c					75
80	56.6	321.2	279,000 b	465,200 b	63.4	325.6	259,900 c	450,100 c					80
85	52.4	317.2	258,700 b	432,700 b	59.5	322.6	240,800 b	418,700 b	69.1	327.4	214,000 c	397,800 c	85
90	47.8	312.5	240,600	404,200	55.3	319.0	223,900 b	391,100 b	65.4	325.0	198,800 c	371,500 c	90
95	42.8	307.1	224,400	379,000	51.0	314.8	208,900	366,600	61.5	322.2	185,300 b	348,200 b	95
100	37.2	300.4	209,800	356,400	46.3	309.9	195,300	344,800	57.5	318.9	173,100 b	327,500 b	100
105	30.7	292.1	196,500	336,100	41.1	304.1	182,900	325,200	53.3	315.0	162,100 b	308,800 b	105
110	22.3	280.6	184,100	317,600	35.3	297.1	171,700	307,400	48.7	310.5	152,100	292,000	110
115					28.4	288.0	161,200	291,200	43.8	305.2	142,800	276,600	115
120					18.8	274.7	151,200	276,300	38.4	298.8	134,300	262,600	120
125									32.1	290.9	126,400	249,700	125
130									24.3	280.3	118,800	237,800	130
135									11.0	261.2	111,000	226,400	135
140													140
145													145
150													150
155													155
160													160
165													165
170													170
175													175
180													180
185													185
190													190
195													195



# MLC650 VPC-MAX S-1

ASME B30.5

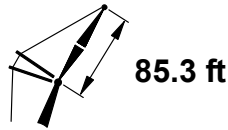
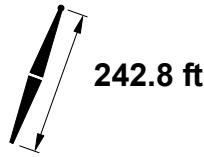

ft	75°				70°				65°				
	ft	ft	lb	lb	ft	ft	lb	lb	ft	ft	lb	ft	
60													60
65													65
70													70
75													75
80													80
85													85
90													90
95													95
100													100
105													105
110													110
115	62.0	317.7	111,400 b	252,400 b									115
120	58.0	314.5	104,600 b	239,600 b									120
125	53.8	310.7	98,200 b	227,800 b									125
130	49.4	306.3	92,300	217,000									130
135	44.5	301.1	86,800	207,000									135
140	39.2	294.9	81,600	197,800	58.2	307.9	56,900 b	178,800 b					140
145	33.0	287.2	76,700	189,100	54.0	304.2	53,200 b	171,000 b					145
150	25.5	277.1	71,800	180,900	49.5	299.8	49,600	163,700					150
155	13.7	260.3	66,800	173,000	44.7	294.6	46,200	156,900					155
160					39.4	288.5	43,000	150,400					160
165					33.3	280.9	39,800	144,300	53.5	295.4	129,200		165
170					25.7	270.8	36,700	138,500	49.0	290.9	124,000		170
175					14.3	254.5	33,300	132,700	44.2	285.7	119,100		175
180									38.8	279.4	114,500		180
185									32.6	271.6	110,100		185
190									24.9	261.3	105,800		190
195									12.4	243.4	101,400		195

# MLC650 VPC-MAX S-1

ASME B30.5

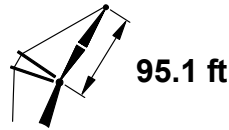
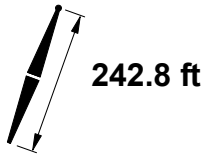

ft	85°				83°				80°				ft
	ft	lb	lb	lb	ft	lb	lb	lb	ft	lb	lb	lb	
60	73.9	342.6	393,700 c	644,500 c									60
65	70.7	340.7	357,200 c	592,900 c									65
70	67.4	338.5	326,300 c	542,400 c									70
75	64.1	336.0	299,800 b	499,400 b	72.9	341.0	303,600 c	524,600 c					75
80	60.6	333.0	276,700 b	462,300 b	69.7	339.1	278,700 c	482,900 c					80
					66.4	336.8	257,100 b	447,000 b					
85	57.0	329.7	256,400 b	430,100 b	63.0	334.1	238,200 b	415,800 b					85
90	53.2	325.8	238,500	401,700	59.5	331.0	221,400 b	388,400 b	68.1	335.9	195,700 b	368,500 b	90
95	49.1	321.4	222,500	376,600	55.8	327.5	206,400	364,100	64.8	333.5	182,300 b	345,300 b	95
100	44.8	316.3	208,100	354,200	51.9	323.5	193,000	342,400	61.3	330.6	170,200 b	324,700 b	100
105	40.1	310.3	195,000	334,100	47.8	318.9	180,800	322,900	57.7	327.4	159,300 b	306,200 b	105
110	34.9	303.1	183,100	315,900	43.4	313.5	169,700	305,300	53.9	323.6	149,400	289,500	110
115	28.7	294.1	172,100	299,300	38.6	307.2	159,600	289,300	50.0	319.3	140,400	274,300	115
120	20.6	281.7	161,700	284,100	33.1	299.5	150,200	274,600	45.7	314.3	132,000	260,400	120
125					26.4	289.7	141,400	261,200	41.1	308.5	124,300	247,700	125
130					17.3	275.4	132,900	248,700	36.0	301.6	117,100	235,900	130
135									30.0	293.1	110,300	225,100	135
140									22.5	281.6	103,800	214,900	140
145									9.4	260.5	97,000	205,100	145
150													150
155													155
160													160
165													165
170													170
175													175
180													180
185													185
190													190
195													195
200													200
205													205

# MLC650 VPC-MAX S-1

ASME B30.5

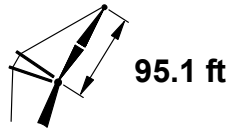
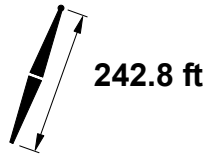

ft	75°				70°				65°				ft
	ft	ft	lb	lb	ft	ft	lb	lb	ft	ft	lb	lb	
60													60
65													65
70													70
75													75
80													80
85													85
90													90
95													95
100													100
105													105
110													110
115													115
120	61.8	326.2	101,300 b	236,800 b									120
125	58.2	323.0	95,100 b	225,200 b									125
130	54.5	319.3	89,300	214,500									130
135	50.5	315.0	84,000	204,600									135
140	46.3	310.2	78,900	195,400									140
145	41.8	304.5	74,200	186,900	58.3	316.4	49,800	168,300					145
150	36.7	297.8	69,700	178,900	54.6	312.7	46,400	161,100					150
155	30.9	289.5	65,400	171,400	50.6	308.5	43,100	154,300					155
160	23.7	278.6	61,200	164,300	46.5	303.7	40,000	148,000					160
165	12.2	260.3	56,700	157,400	41.9	298.0	37,100	142,000					165
170					36.9	291.3	34,300	136,400	54.2	304.0	121,300		170
175					31.1	283.1	31,500	131,000	50.2	299.7	116,600		175
180					23.9	272.3	28,700	125,900	46.0	294.8	112,100		180
185					12.8	254.5	25,600	120,800	41.4	289.1	107,700		185
190									36.4	282.2	103,600		190
195									30.5	273.8	99,700		195
200									23.1	262.7	95,800		200
205									10.9	243.1	91,900		205

# MLC650 VPC-MAX S-1

ASME B30.5

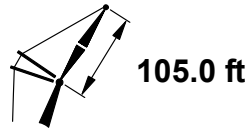
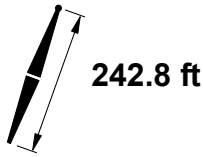

ft	85°				83°				80°				ft
	ft	lb	lb	lb	ft	lb	lb	lb	ft	lb	lb	lb	
65	72.6	351.2	355,800 c	590,200 c									65
70	69.7	349.3	324,900 c	540,000 c									70
75	66.7	347.0	298,500 b	497,200 b	71.7	349.6	277,100 c	480,600 c					75
80	63.6	344.4	275,500 b	460,300 b	68.8	347.6	255,600 b	444,900 b					80
85	60.5	341.5	255,300 b	428,300 b	65.8	345.3	236,700 b	413,800 b					85
90	57.2	338.2	237,500	400,100	62.7	342.6	220,000 b	386,500 b					90
95	53.8	334.4	221,600	375,100	59.5	339.5	205,200 b	362,400 b	67.3	344.5	180,600 b	343,400 b	95
100	50.2	330.2	207,300	352,800	56.1	336.1	191,800	340,800	64.3	341.9	168,600 b	322,900 b	100
105	46.4	325.3	194,400	332,800	52.7	332.2	179,800	321,400	61.1	339.1	157,800 b	304,500 b	105
110	42.3	319.8	182,600	314,700	49.0	327.7	168,800	303,900	57.9	335.9	148,000	287,900	110
115	37.9	313.3	171,800	298,300	45.2	322.7	158,800	288,100	54.5	332.2	139,000	272,800	115
120	32.9	305.6	161,900	283,300	41.0	316.9	149,600	273,600	50.9	328.0	130,800	259,000	120
125	26.9	296.0	152,700	269,500	36.4	310.0	141,000	260,300	47.2	323.3	123,200	246,400	125
130	19.2	282.7	143,900	256,700	31.1	301.8	133,100	248,000	43.2	317.9	116,200	234,800	130
135					24.8	291.4	125,600	236,600	38.8	311.6	109,600	224,100	135
140					15.9	275.9	118,200	226,000	33.9	304.2	103,500	214,100	140
145									28.2	295.1	97,600	204,800	145
150									21.0	282.8	92,000	196,000	150
155									8.0	259.4	85,900	187,600	155
160													160
165													165
170													170
175													175
180													180
185													185
190													190
195													195
200													200
205													205
210													210
215													215

# MLC650 VPC-MAX S-1

ASME B30.5

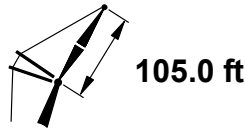
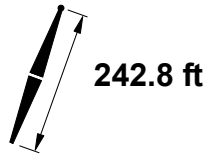

ft	75°				70°				65°				
	ft	ft	lb	lb	ft	ft	lb	lb	ft	ft	lb	lb	
65													65
70													70
75													75
80													80
85													85
90													90
95													95
100													100
105													105
110													110
115													115
120	64.7	337.4	99,500	235,100									120
125	61.5	334.6	93,300	223,500									125
130	58.3	331.4	87,700	212,900									130
135	55.0	327.8	82,400	203,100									135
140	51.4	323.8	77,500	194,000									140
145	47.7	319.1	72,800	185,600									145
150	43.7	313.8	68,500	177,700	58.4	324.9	44,500	159,500					150
155	39.4	307.7	64,400	170,400	55.1	321.3	41,400	152,800					155
160	34.6	300.4	60,500	163,400	51.5	317.2	38,400	146,600					160
165	29.1	291.6	56,700	156,900	47.8	312.6	35,600	140,700					165
170	22.1	279.9	53,000	150,700	43.9	307.3	32,900	135,200					170
175	10.9	260.0	49,000	144,500	39.6	301.2	30,300	129,900	54.7	312.6	115,000		175
180					34.8	294.0	27,700	124,900	51.2	308.4	110,600		180
185					29.3	285.2	25,300	120,200	47.5	303.8	106,400		185
190					22.4	273.7	22,800	115,600	43.5	298.4	102,400		190
195					11.5	254.4	20,000	111,000	39.1	292.2	98,500		195
200									34.3	284.9	94,900		200
205									28.7	275.9	91,300		205
210									21.6	263.9	87,900		210
215									9.6	242.5	84,200		215

# MLC650 VPC-MAX S-1

ASME B30.5

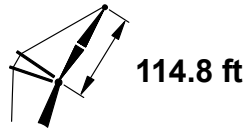
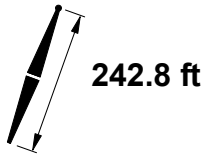

ft	85°				83°				80°				ft
	ft	lb	lb	lb	ft	lb	lb	lb	ft	lb	lb	lb	
65	74.2	361.6	353,000 c	572,200 c									65
70	71.5	359.9	322,200 b	536,600 b									70
75	68.8	357.8	295,800 b	494,100 b									75
80	66.1	355.5	272,900 b	457,400 b	70.7	358.3	252,700 b	441,800 b					80
85	63.3	352.9	252,800 b	425,500 b	68.0	356.1	233,900 b	410,900 b					85
90	60.4	350.0	235,000	397,400	65.2	353.7	217,300 b	383,700 b					90
95	57.4	346.7	219,200	372,600	62.4	351.0	202,500	359,700	69.4	355.2	177,400 b	340,500 b	95
100	54.3	343.0	205,000	350,400	59.5	348.0	189,200	338,200	66.6	353.0	165,500 b	320,100 b	100
105	51.1	338.9	192,200	330,500	56.4	344.6	177,200	318,900	63.9	350.4	154,800	301,800	105
110	47.7	334.3	180,500	312,500	53.3	340.8	166,300	301,500	61.0	347.6	145,100	285,200	110
115	44.1	329.0	169,900	296,200	50.0	336.5	156,400	285,800	58.0	344.4	136,200	270,200	115
120	40.2	323.0	160,100	281,300	46.6	331.7	147,300	271,400	54.9	340.8	128,100	256,500	120
125	35.9	316.1	151,000	267,600	42.9	326.2	138,900	258,200	51.7	336.7	120,600	244,000	125
130	31.1	307.9	142,600	255,100	38.9	320.0	131,100	246,000	48.4	332.2	113,600	232,500	130
135	25.4	297.7	134,700	243,400	34.5	312.7	123,900	234,800	44.8	327.1	107,200	221,800	135
140	18.0	283.5	127,200	232,500	29.5	304.0	117,000	224,400	41.0	321.3	101,200	212,000	140
145					23.4	292.8	110,500	214,600	36.8	314.6	95,500	202,800	145
150					14.8	276.3	104,100	205,400	32.1	306.6	90,200	194,200	150
155									26.7	296.9	85,100	186,200	155
160									19.7	283.9	80,100	178,600	160
165									6.5	257.9	74,700	171,100	165
170													170
175													175
180													180
185													185
190													190
195													195
200													200
205													205
210													210
215													215
220													220
225													225

# MLC650 VPC-MAX S-1

ASME B30.5

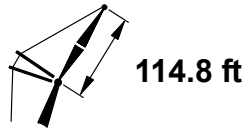
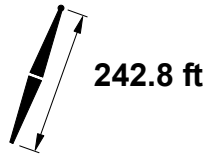

ft	75°				70°				65°				
	ft	lb	ft	lb	ft	lb	ft	lb	ft	lb	ft	lb	
65													65
70													70
75													75
80													80
85													85
90													90
95													95
100													100
105													105
110													110
115													115
120													120
125	64.2	345.9	90,000	220,700									125
130	61.4	343.1	84,400	210,200									130
135	58.4	339.9	79,200	200,500									135
140	55.4	336.4	74,400	191,500									140
145	52.2	332.4	69,900	183,100									145
150	48.8	328.0	65,600	175,300									150
155	45.3	322.9	61,600	168,000	58.5	333.4	38,000	150,100					155
160	41.5	317.2	57,800	161,200	55.5	329.9	35,100	143,900					160
165	37.4	310.6	54,200	154,800	52.3	325.9	32,400	138,100					165
170	32.8	302.9	50,800	148,700	48.9	321.5	29,800	132,700					170
175	27.5	293.5	47,400	143,000	45.4	316.5	27,300	127,500					175
180	20.8	281.1	44,100	137,500	41.6	310.8	24,900	122,600					180
185	9.7	259.5	40,500	132,000	37.5	304.2	22,600	118,000	52.0	317.1	103,800		185
190					33.0	296.5	20,300	113,600	48.6	312.6	99,800		190
195					27.7	287.2		109,300	45.1	307.5	96,100		195
200					21.0	274.9		105,200	41.3	301.8	92,500		200
205					10.3	254.0		101,100	37.1	295.1	89,000		205
210									32.5	287.3	85,800		210
215									27.1	277.7	82,600		215
220									20.3	265.0	79,400		220
225									8.3	241.7	76,100		225

# MLC650 VPC-MAX S-1

ASME B30.5

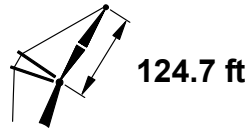
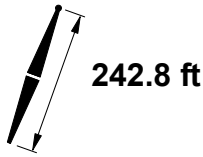

ft	85°				83°				80°				ft
	ft	lb	lb	lb	ft	lb	lb	lb	ft	lb	lb	lb	
70	73.0	370.3	380,800 b	507,300 b									70
75	70.6	368.5	350,200 b	493,000 b									75
80	68.1	366.4	323,700 b	456,500 b	72.3	368.8	303,200 b	440,800 b					80
85	65.6	364.0	300,500 b	424,700 b	69.8	366.8	281,300 b	410,100 b					85
90	63.0	361.4	280,000	396,800	67.3	364.7	262,000 b	383,000 b					90
95	60.3	358.5	261,700	372,100	64.8	362.2	244,800	359,100					95
100	57.6	355.2	245,300	350,000	62.2	359.5	229,300	337,700	68.6	363.8	205,400	319,500	100
105	54.7	351.6	230,600	330,200	59.5	356.5	215,400	318,600	66.1	361.5	192,700	301,300	105
110	51.8	347.6	217,200	312,300	56.7	353.1	202,800	301,200	63.5	358.9	181,200	284,800	110
115	48.7	343.1	205,000	296,000	53.8	349.4	191,300	285,500	60.9	356.0	170,700	269,900	115
120	45.5	338.1	193,800	281,200	50.8	345.2	180,700	271,200	58.1	352.8	161,200	256,300	120
125	42.0	332.5	183,500	267,600	47.7	340.6	171,000	258,100	55.3	349.3	152,400	243,800	125
130	38.3	326.1	174,000	255,200	44.4	335.4	162,100	246,000	52.4	345.4	144,200	232,300	130
135	34.2	318.8	165,100	243,600	40.9	329.6	153,800	234,900	49.3	341.0	136,700	221,800	135
140	29.6	310.1	156,800	232,900	37.1	322.9	146,000	224,500	46.1	336.1	129,700	212,000	140
145	24.1	299.2	149,000	223,000	32.8	315.2	138,800	214,900	42.7	330.6	123,100	202,900	145
150	16.9	284.3	141,400	213,600	28.0	306.0	131,900	205,900	39.1	324.4	117,000	194,400	150
155					22.1	294.2	125,400	197,500	35.1	317.3	111,200	186,400	155
160					13.7	276.6	118,900	189,500	30.6	308.9	105,700	179,000	160
165									25.3	298.6	100,500	172,000	165
170									18.6	284.8	95,300	165,300	170
175									4.9	255.6	89,700	158,600	175
180													180
185													185
190													190
195													195
200													200
205													205
210													210
215													215
220													220
225													225
230													230
235													235



# MLC650 VPC-MAX S-1

ASME B30.5

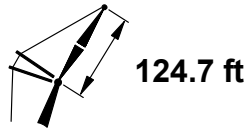
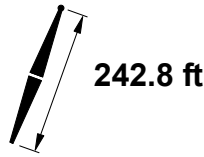

ft	75°				70°				65°				
	ft	ft	lb	lb	ft	ft	lb	lb	ft	ft	lb	ft	
70													70
75													75
80													80
85													85
90													90
95													95
100													100
105													105
110													110
115													115
120													120
125													125
130	63.9	354.4	114,600	209,900									130
135	61.2	351.6	108,300	200,200									135
140	58.5	348.4	102,400	191,300									140
145	55.7	344.9	97,000	183,000									145
150	52.8	341.0	91,900	175,200									150
155	49.8	336.7	87,100	168,000									155
160	46.6	331.9	82,500	161,200	58.6	341.9	59,400	143,800					160
165	43.2	326.5	78,300	154,900	55.8	338.4	56,000	138,000					165
170	39.6	320.4	74,200	148,900	52.9	334.5	52,700	132,600					170
175	35.6	313.4	70,400	143,200	49.9	330.2	49,600	127,500					175
180	31.2	305.2	66,700	137,900	46.7	325.4	46,600	122,700					180
185	26.1	295.3	63,100	132,800	43.3	320.1	43,800	118,100					185
190	19.6	282.1	59,500	127,900	39.7	314.0	41,100	113,700	52.6	325.7	99,800		190
195	8.6	258.8	55,700	123,000	35.8	307.0	38,500	109,600	49.6	321.4	96,100		195
200					31.4	298.9	36,000	105,600	46.4	316.6	92,500		200
205					26.3	289.0	33,500	101,800	43.0	311.1	89,200		205
210					19.9	276.0	31,000	98,100	39.3	305.0	85,900		210
215					9.3	253.4	28,200	94,400	35.3	297.9	82,800		215
220									30.9	289.6	79,900		220
225									25.7	279.5	77,000		225
230									19.1	266.0	74,100		230
235									7.1	240.5	71,100		235

# MLC650 VPC-MAX S-1

ASME B30.5

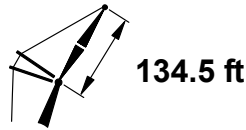
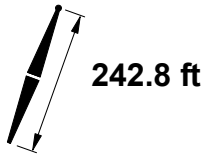

ft	85°				83°				80°				ft
	ft	lb	lb	lb	ft	lb	lb	lb	ft	lb	lb	lb	
70	74.3	380.7	378,100 b	491,300 b									70
75	72.1	379.0	347,600 b	485,600 b									75
80	69.8	377.1	321,100 b	453,600 b									80
85	67.5	374.9	297,900	421,900	71.4	377.4	278,500 b	407,100 b					85
90	65.1	372.5	277,500	394,200	69.1	375.4	259,200	380,200					90
95	62.7	369.9	259,300	369,500	66.8	373.2	242,000	356,400					95
100	60.3	366.9	242,900	347,500	64.4	370.7	226,600	335,100					100
105	57.7	363.7	228,200	327,800	62.0	368.0	212,800	316,000	68.0	372.3	189,700	298,500	105
110	55.1	360.1	214,900	310,000	59.5	365.0	200,200	298,800	65.6	370.0	178,200	282,200	110
115	52.4	356.2	202,700	293,800	56.9	361.6	188,700	283,200	63.2	367.4	167,800	267,300	115
120	49.6	351.9	191,600	279,100	54.3	357.9	178,200	268,900	60.8	364.5	158,300	253,800	120
125	46.6	347.1	181,300	265,600	51.5	353.9	168,600	255,800	58.2	361.3	149,600	241,400	125
130	43.5	341.8	171,900	253,200	48.7	349.4	159,700	243,800	55.6	357.8	141,500	230,000	130
135	40.2	335.8	163,100	241,700	45.7	344.5	151,500	232,800	52.9	354.0	134,000	219,400	135
140	36.6	329.0	155,000	231,100	42.5	339.0	143,800	222,500	50.2	349.7	127,100	209,700	140
145	32.7	321.3	147,300	221,200	39.1	332.8	136,700	213,000	47.2	345.0	120,600	200,700	145
150	28.2	312.1	140,100	212,000	35.4	325.7	130,000	204,100	44.2	339.8	114,500	192,200	150
155	22.9	300.7	133,300	203,300	31.4	317.6	123,600	195,800	40.9	334.0	108,800	184,400	155
160	15.9	284.9	126,700	195,200	26.7	307.8	117,600	187,900	37.4	327.4	103,500	177,000	160
165					21.0	295.4	111,900	180,600	33.5	319.9	98,400	170,100	165
170					12.8	276.8	106,100	173,500	29.2	311.0	93,500	163,500	170
175									24.1	300.2	88,900	157,300	175
180									17.6	285.6	84,300	151,400	180
185													185
190													190
195													195
200													200
205													205
210													210
215													215
220													220
225													225
230													230
235													235
240													240
245													245

# MLC650 VPC-MAX S-1

ASME B30.5

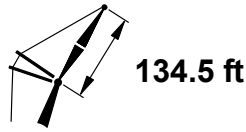
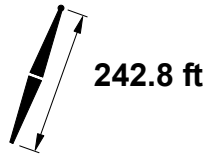

ft	75°				70°				65°				
	ft	lb	lb	lb	ft	lb	lb	lb	ft	lb	lb	ft	
70													70
75													75
80													80
85													85
90													90
95													95
100													100
105													105
110													110
115													115
120													120
125													125
130													130
135	63.5	362.9	105,100	197,600									135
140	61.1	360.0	99,300	188,700									140
145	58.6	356.9	93,900	180,400									145
150	56.0	353.5	88,800	172,800									150
155	53.3	349.7	84,100	165,600									155
160	50.5	345.5	79,600	158,900									160
165	47.6	340.8	75,400	152,600	58.7	350.4	52,600	135,400					165
170	44.6	335.7	71,500	146,600	56.1	346.9	49,400	130,000					170
175	41.3	330.0	67,700	141,000	53.4	343.1	46,400	125,000					175
180	37.9	323.5	64,100	135,800	50.6	339.0	43,500	120,200					180
185	34.1	316.1	60,700	130,700	47.7	334.3	40,800	115,700					185
190	29.8	307.4	57,400	126,000	44.7	329.2	38,200	111,400					190
195	24.8	296.9	54,200	121,400	41.4	323.5	35,700	107,300	53.1	334.4	93,500		195
200	18.6	283.1	51,000	117,000	38.0	317.1	33,300	103,400	50.3	330.1	90,000		200
205	7.6	257.8	47,400	112,600	34.2	309.7	30,900	99,700	47.4	325.5	86,700		205
210					30.0	301.1	28,700	96,200	44.4	320.3	83,500		210
215					25.0	290.7	26,400	92,700	41.1	314.5	80,500		215
220					18.8	277.0	24,100	89,400	37.6	308.0	77,600		220
225					8.2	252.7	21,500	85,900	33.8	300.5	74,800		225
230									29.5	291.8	72,100		230
235									24.5	281.1	69,400		235
240									18.1	266.9	66,800		240
245									5.9	238.8	64,000		245

# MLC650 VPC-MAX S-1

ASME B30.5

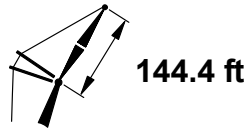
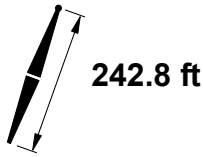

ft	85°				83°				80°				ft
	ft	lb	lb	lb	ft	lb	lb	lb	ft	lb	lb	lb	
75	73.4	389.4	345,700 b	454,800 b									75
80	71.3	387.6	319,300	451,200									80
85	69.1	385.6	296,100	419,700	72.7	387.9	276,500	404,800					85
90	67.0	383.4	275,700	392,000	70.6	386.0	257,200	378,000					90
95	64.7	381.0	257,500	367,500	68.4	384.0	240,100	354,300					95
100	62.5	378.3	241,200	345,600	66.3	381.7	224,700	333,100					100
105	60.2	375.4	226,500	325,900	64.0	379.2	210,900	314,100	69.6	383.0	187,600	296,500	105
110	57.8	372.2	213,200	308,200	61.8	376.5	198,400	296,900	67.4	380.9	176,200	280,200	110
115	55.4	368.7	201,100	292,100	59.5	373.4	186,900	281,400	65.2	378.5	165,800	265,400	115
120	52.9	364.8	190,000	277,400	57.1	370.1	176,500	267,200	63.0	375.9	156,400	251,900	120
125	50.3	360.6	179,800	264,000	54.6	366.5	166,900	254,100	60.7	373.0	147,600	239,600	125
130	47.6	356.0	170,400	251,600	52.1	362.5	158,100	242,200	58.3	369.8	139,600	228,200	130
135	44.8	350.9	161,700	240,200	49.5	358.2	149,900	231,200	55.9	366.4	132,200	217,700	135
140	41.8	345.2	153,600	229,600	46.7	353.4	142,300	220,900	53.4	362.6	125,300	208,000	140
145	38.6	338.9	146,100	219,800	43.9	348.2	135,200	211,500	50.8	358.4	118,800	199,000	145
150	35.1	331.8	139,000	210,600	40.8	342.3	128,500	202,600	48.2	353.9	112,800	190,700	150
155	31.3	323.6	132,300	202,100	37.5	335.8	122,300	194,400	45.4	348.9	107,200	182,800	155
160	27.0	314.0	126,000	194,100	34.0	328.4	116,400	186,600	42.4	343.4	101,900	175,500	160
165	21.9	302.1	120,000	186,500	30.1	319.8	110,900	179,400	39.3	337.2	96,900	168,600	165
170	15.0	285.4	114,100	179,300	25.5	309.6	105,600	172,500	35.9	330.3	92,200	162,200	170
175					20.0	296.6	100,400	166,000	32.1	322.4	87,700	156,100	175
180					11.9	276.8	95,300	159,800	28.0	313.1	83,400	150,300	180
185									23.0	301.7	79,200	144,800	185
190									16.6	286.4	75,100	139,500	190
195													195
200													200
205													205
210													210
215													215
220													220
225													225
230													230
235													235
240													240
245													245
250													250
255													255

# MLC650 VPC-MAX S-1

ASME B30.5

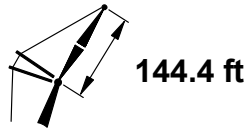
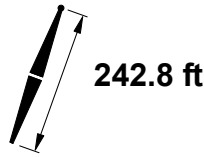

ft	75°				70°				65°			
	ft	lb	ft	lb	ft	lb	ft	lb	ft	lb	ft	
75												75
80												80
85												85
90												90
95												95
100												100
105												105
110												110
115												115
120												120
125												125
130												130
135												135
140	63.3	371.4	97,200	186,800								140
145	61.0	368.5	91,800	178,600								145
150	58.6	365.4	86,800	171,000								150
155	56.2	362.0	82,100	163,900								155
160	53.8	358.2	77,700	157,200								160
165	51.2	354.1	73,500	150,900								165
170	48.5	349.7	69,600	145,000	58.7	358.8	47,300	128,300				170
175	45.7	344.7	65,900	139,500	56.3	355.4	44,300	123,200				175
180	42.8	339.3	62,400	134,300	53.8	351.7	41,500	118,500				180
185	39.7	333.2	59,000	129,300	51.3	347.6	38,800	114,000				185
190	36.3	326.4	55,800	124,600	48.6	343.2	36,200	109,800				190
195	32.7	318.6	52,700	120,100	45.8	338.2	33,800	105,700				195
200	28.5	309.5	49,800	115,800	42.9	332.8	31,400	101,900	53.6	342.9	88,300	200
205	23.7	298.5	46,900	111,700	39.8	326.8	29,100	98,200	51.0	338.8	85,000	205
210	17.6	283.9	43,900	107,700	36.4	320.0	27,000	94,700	48.3	334.3	81,900	210
215	6.5	256.4	40,700	103,700	32.8	312.2	24,900	91,400	45.6	329.4	78,900	215
220					28.7	303.2	22,800	88,200	42.6	323.9	76,000	220
225					23.9	292.2	20,800	85,100	39.5	317.7	73,300	225
230					17.9	277.8		82,000	36.1	310.9	70,600	230
235					7.2	251.6		78,800	32.4	303.0	68,100	235
240									28.3	293.8	65,600	240
245									23.4	282.6	63,200	245
250									17.1	267.7	60,800	250
255									4.5	236.4	58,200	255

# MLC650 VPC-MAX S-1

ASME B30.5

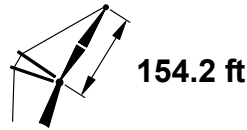
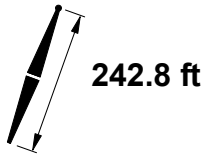

ft	85°				83°				80°				ft
	ft	lb	lb	lb	ft	lb	lb	lb	ft	lb	lb	lb	
75	74.5	399.7	343,000 b	421,400 b									75
80	72.5	398.1	316,700	421,400									80
85	70.5	396.2	293,500	417,000									85
90	68.5	394.2	273,100	389,400	71.9	396.5	254,400	375,200					90
95	66.5	392.0	255,000	365,000	69.9	394.6	237,300	351,600					95
100	64.4	389.5	238,700	343,200	67.9	392.5	222,000	330,500					100
105	62.3	386.8	224,100	323,600	65.8	390.2	208,200	311,600					105
110	60.2	383.9	210,800	305,900	63.8	387.7	195,700	294,500	68.9	391.6	173,200	277,500	110
115	57.9	380.7	198,700	289,900	61.6	384.9	184,300	279,000	66.9	389.4	162,900	262,800	115
120	55.7	377.2	187,700	275,200	59.5	381.9	173,900	264,800	64.8	387.0	153,400	249,400	120
125	53.4	373.4	177,500	261,800	57.2	378.6	164,400	251,900	62.7	384.3	144,800	237,100	125
130	50.9	369.3	168,200	249,500	55.0	375.1	155,600	240,000	60.6	381.5	136,800	225,800	130
135	48.4	364.8	159,500	238,100	52.6	371.2	147,400	229,000	58.4	378.3	129,400	215,400	135
140	45.8	359.9	151,500	227,600	50.2	366.9	139,900	218,800	56.1	374.9	122,500	205,700	140
145	43.1	354.5	144,000	217,900	47.6	362.3	132,800	209,400	53.8	371.2	116,200	196,800	145
150	40.2	348.5	137,000	208,800	45.0	357.3	126,200	200,600	51.4	367.1	110,200	188,400	150
155	37.1	341.9	130,400	200,300	42.2	351.7	120,100	192,400	49.0	362.7	104,600	180,700	155
160	33.8	334.5	124,200	192,300	39.3	345.5	114,300	184,700	46.4	357.9	99,400	173,400	160
165	30.1	325.9	118,300	184,800	36.1	338.7	108,800	177,500	43.7	352.6	94,400	166,600	165
170	25.9	315.8	112,800	177,800	32.7	330.9	103,600	170,700	40.8	346.7	89,800	160,100	170
175	20.9	303.3	107,400	171,100	28.9	321.9	98,700	164,300	37.8	340.3	85,300	154,100	175
180	14.2	285.8	102,200	164,700	24.5	311.2	94,000	158,200	34.5	333.0	81,100	148,400	180
185					19.1	297.6	89,400	152,400	30.9	324.7	77,100	142,900	185
190					11.1	276.7	84,800	146,800	26.8	315.0	73,300	137,800	190
195									22.0	303.1	69,500	132,800	195
200									15.8	287.0	65,800	128,100	200
205													205
210													210
215													215
220													220
225													225
230													230
235													235
240													240
245													245
250													250
255													255
260													260
265													265

# MLC650 VPC-MAX S-1

ASME B30.5

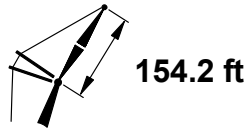
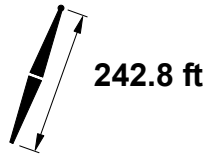

ft	75°				70°				65°			
	ft	lb	ft	lb	ft	lb	ft	lb	ft	lb	ft	
75												75
80												80
85												85
90												90
95												95
100												100
105												105
110												110
115												115
120												120
125												125
130												130
135												135
140												140
145	63.0	379.8	88,600	176,100								145
150	60.9	377.0	83,700	168,500								150
155	58.7	373.9	79,000	161,400								155
160	56.4	370.5	74,700	154,800								160
165	54.1	366.8	70,600	148,500								165
170	51.8	362.8	66,700	142,700								170
175	49.3	358.4	63,000	137,200	58.8	367.3	41,000	120,700				175
180	46.7	353.7	59,600	132,000	56.5	364.0	38,300	116,000				180
185	44.0	348.4	56,300	127,100	54.2	360.3	35,600	111,500				185
190	41.2	342.7	53,100	122,400	51.8	356.3	33,100	107,300				190
195	38.2	336.3	50,100	118,000	49.4	351.9	30,700	103,300				195
200	35.0	329.1	47,300	113,800	46.8	347.2	28,400	99,500				200
205	31.4	321.0	44,500	109,800	44.1	342.0	26,200	95,900	54.0	351.5	82,400	205
210	27.4	311.5	41,800	105,900	41.3	336.2	24,100	92,500	51.6	347.5	79,300	210
215	22.7	300.0	39,200	102,200	38.3	329.9	22,100	89,200	49.1	343.1	76,400	215
220	16.8	284.7	36,500	98,600	35.1	322.7	20,100	86,000	46.6	338.3	73,600	220
225	5.4	254.6	33,500	94,900	31.5	314.6		83,000	43.9	333.1	70,900	225
230					27.6	305.2		80,100	41.0	327.3	68,300	230
235					22.9	293.7		77,200	38.0	320.8	65,800	235
240					17.0	278.6		74,400	34.7	313.6	63,400	240
245					6.3	250.2		71,500	31.2	305.4	61,100	245
250									27.1	295.8	58,800	250
255									22.4	284.1	56,600	255
260									16.3	268.4	54,400	260
265									2.1	230.7	51,800	265

# MLC650 VPC-MAX S-1

ASME B30.5

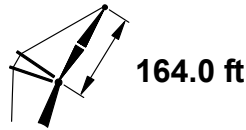
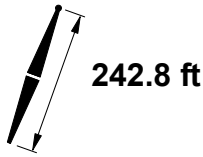

ft	85°				83°				80°				ft
	ft	lb	lb	lb	ft	lb	lb	lb	ft	lb	lb	lb	
80	73.6	408.5	315,900	391,000									80
85	71.7	406.7	292,900	390,800									85
90	69.9	404.9	272,500	388,100									90
95	68.0	402.8	254,400	363,800	71.2	405.2	236,500	350,300					95
100	66.1	400.5	238,100	342,100	69.3	403.2	221,200	329,400					100
105	64.1	398.0	223,500	322,600	67.4	401.1	207,500	310,500					105
110	62.1	395.3	210,200	305,000	65.5	398.7	195,000	293,500					110
115	60.1	392.4	198,200	289,000	63.5	396.2	183,700	278,000	68.4	400.2	162,000	261,700	115
120	58.0	389.2	187,200	274,400	61.5	393.4	173,300	263,900	66.5	397.9	152,600	248,400	120
125	55.9	385.7	177,000	261,000	59.5	390.4	163,800	251,000	64.5	395.5	144,000	236,100	125
130	53.7	382.0	167,700	248,800	57.4	387.1	155,000	239,200	62.5	392.8	136,000	224,900	130
135	51.5	378.0	159,100	237,400	55.2	383.6	146,900	228,200	60.5	389.9	128,600	214,500	135
140	49.2	373.6	151,100	227,000	53.0	379.8	139,300	218,100	58.5	386.8	121,800	204,900	140
145	46.8	368.8	143,600	217,200	50.8	375.6	132,300	208,700	56.4	383.4	115,500	196,000	145
150	44.3	363.6	136,600	208,200	48.4	371.1	125,800	199,900	54.2	379.7	109,500	187,700	150
155	41.6	358.0	130,100	199,700	46.0	366.3	119,600	191,800	52.0	375.8	104,000	179,900	155
160	38.8	351.7	124,000	191,800	43.4	360.9	113,900	184,100	49.7	371.5	98,800	172,700	160
165	35.8	344.8	118,200	184,400	40.8	355.1	108,500	177,000	47.3	366.8	93,900	165,900	165
170	32.6	337.0	112,700	177,400	37.9	348.6	103,400	170,200	44.8	361.7	89,200	159,500	170
175	29.0	328.0	107,600	170,800	34.8	341.4	98,500	163,900	42.2	356.1	84,900	153,500	175
180	25.0	317.5	102,600	164,500	31.5	333.3	93,900	157,800	39.4	350.0	80,700	147,800	180
185	20.1	304.5	97,800	158,600	27.8	324.0	89,500	152,100	36.5	343.2	76,800	142,400	185
190	13.4	286.1	93,100	152,900	23.5	312.8	85,300	146,700	33.3	335.6	73,000	137,300	190
195					18.3	298.6	81,100	141,500	29.8	326.9	69,400	132,500	195
200					10.4	276.5	76,900	136,500	25.8	316.8	66,000	127,900	200
205									21.2	304.4	62,600	123,400	205
210									15.0	287.5	59,200	119,100	210
215													215
220													220
225													225
230													230
235													235
240													240
245													245
250													250
255													255
260													260
265													265
270													270



# MLC650 VPC-MAX S-1

ASME B30.5

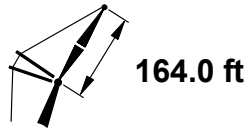
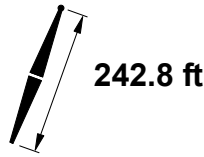

ft	75°				70°				65°			
	ft	lb	ft	lb	ft	lb	ft	lb	ft	lb	ft	
80												80
85												85
90												90
95												95
100												100
105												105
110												110
115												115
120												120
125												125
130												130
135												135
140												140
145	64.8	390.9	87,700	175,100								145
150	62.8	388.3	82,700	167,500								150
155	60.8	385.5	78,100	160,500								155
160	58.7	382.4	73,800	153,900								160
165	56.6	379.0	69,700	147,700								165
170	54.5	375.4	65,900	141,900								170
175	52.3	371.4	62,300	136,400								175
180	50.0	367.2	58,800	131,300	58.8	375.8	37,300	115,100				180
185	47.6	362.6	55,600	126,400	56.7	372.5	34,600	110,700				185
190	45.1	357.5	52,500	121,800	54.5	368.8	32,200	106,500				190
195	42.5	352.0	49,500	117,400	52.3	364.9	29,800	102,500				195
200	39.8	346.0	46,700	113,200	50.0	360.7	27,500	98,800				200
205	36.9	339.3	44,000	109,200	47.7	356.1	25,400	95,200				205
210	33.7	331.8	41,400	105,400	45.2	351.0	23,300	91,800	54.3	360.1	78,500	210
215	30.3	323.3	38,900	101,800	42.6	345.5	21,300	88,500	52.1	356.1	75,600	215
220	26.4	313.4	36,400	98,300	39.9	339.5		85,400	49.8	351.8	72,800	220
225	21.8	301.3	34,000	94,900	37.0	332.9		82,400	47.4	347.2	70,100	225
230	16.0	285.3	31,600	91,600	33.8	325.4		79,500	44.9	342.1	67,600	230
235	4.2	252.0	28,700	88,200	30.4	316.9		76,800	42.3	336.6	65,100	235
240					26.5	307.1		74,100	39.6	330.5	62,700	240
245					22.0	295.1		71,500	36.7	323.8	60,500	245
250					16.2	279.3		68,900	33.5	316.2	58,300	250
255					5.2	248.3		66,200	30.0	307.6	56,100	255
260									26.1	297.6	54,000	260
265									21.5	285.4	52,000	265
270									15.5	269.0	50,000	270

# MLC650 VPC-MAX S-1

ASME B30.5

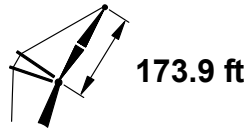
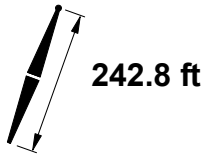

ft	85°				83°				80°				ft
	ft	lb	lb	lb	ft	lb	lb	lb	ft	lb	lb	lb	
80	74.6	418.8	313,300	362,000									80
85	72.8	417.2	290,300	362,000									85
90	71.1	415.4	269,900	361,700									90
95	69.3	413.4	251,800	360,300	72.3	415.6	233,700	347,700					95
100	67.5	411.3	235,600	339,600	70.5	413.8	218,500	326,800					100
105	65.7	409.0	221,000	320,200	68.7	411.8	204,800	308,000					105
110	63.9	406.5	207,800	302,700	67.0	409.6	192,300	291,000					110
115	62.0	403.8	195,800	286,700	65.1	407.2	181,000	275,600	69.7	410.8	159,000	259,100	115
120	60.1	400.8	184,800	272,200	63.3	404.7	170,700	261,600	67.9	408.7	149,700	245,800	120
125	58.1	397.7	174,700	258,900	61.4	401.9	161,200	248,700	66.1	406.4	141,100	233,600	125
130	56.1	394.3	165,400	246,700	59.5	398.9	152,400	236,900	64.2	404.0	133,100	222,400	130
135	54.1	390.6	156,800	235,400	57.5	395.6	144,300	226,000	62.4	401.3	125,800	212,100	135
140	52.0	386.6	148,800	224,900	55.5	392.1	136,800	215,900	60.5	398.4	119,000	202,600	140
145	49.8	382.3	141,400	215,200	53.4	388.4	129,900	206,600	58.5	395.3	112,700	193,700	145
150	47.6	377.7	134,400	206,200	51.3	384.3	123,400	197,900	56.5	391.9	106,800	185,400	150
155	45.2	372.7	127,900	197,800	49.1	379.9	117,300	189,700	54.5	388.3	101,300	177,700	155
160	42.8	367.2	121,800	189,900	46.8	375.2	111,500	182,100	52.4	384.4	96,100	170,500	160
165	40.2	361.3	116,100	182,500	44.5	370.0	106,200	175,000	50.3	380.2	91,300	163,800	165
170	37.5	354.8	110,700	175,600	42.0	364.4	101,100	168,300	48.0	375.6	86,700	157,400	170
175	34.6	347.5	105,600	169,000	39.4	358.3	96,300	162,000	45.7	370.7	82,400	151,400	175
180	31.5	339.4	100,700	162,800	36.6	351.6	91,800	156,000	43.3	365.3	78,300	145,800	180
185	28.0	330.1	96,100	157,000	33.7	344.1	87,400	150,300	40.8	359.5	74,400	140,400	185
190	24.0	319.2	91,600	151,400	30.4	335.6	83,300	145,000	38.1	353.1	70,700	135,400	190
195	19.3	305.6	87,300	146,100	26.8	325.9	79,400	139,900	35.2	346.0	67,200	130,600	195
200	12.7	286.3	83,000	140,900	22.7	314.3	75,500	135,000	32.1	338.1	63,800	126,000	200
205					17.5	299.4	71,800	130,300	28.7	329.0	60,500	121,600	205
210					9.7	276.1	67,900	125,800	24.9	318.5	57,400	117,500	210
215									20.3	305.6	54,300	113,400	215
220									14.3	288.0	51,200	109,500	220
225													225
230													230
235													235
240													240
245													245
250													250
255													255
260													260
265													265
270													270
275													275
280													280

# MLC650 VPC-MAX S-1

ASME B30.5

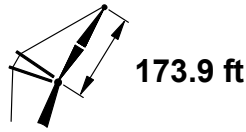
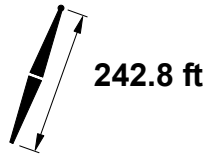

ft	75°				70°				65°			
	ft	lb	ft	lb	ft	lb	ft	lb	ft	lb	ft	
80												80
85												85
90												90
95												95
100												100
105												105
110												110
115												115
120												120
125												125
130												130
135												135
140												140
145												145
150	64.5	399.4	79,600	165,000								150
155	62.6	396.8	75,000	158,000								155
160	60.7	393.9	70,700	151,500								160
165	58.8	390.8	66,700	145,300								165
170	56.8	387.5	62,900	139,500								170
175	54.8	383.9	59,300	134,100								175
180	52.7	380.1	55,900	129,000								180
185	50.5	375.9	52,700	124,100	58.8	384.3	31,400	108,200				185
190	48.3	371.4	49,700	119,500	56.9	381.0	29,000	104,000				190
195	46.0	366.5	46,800	115,200	54.8	377.4	26,700	100,100				195
200	43.6	361.2	44,000	111,000	52.8	373.5	24,500	96,400				200
205	41.1	355.4	41,300	107,100	50.6	369.4	22,300	92,800				205
210	38.5	349.1	38,800	103,300	48.4	364.9	20,300	89,400				210
215	35.6	342.1	36,400	99,700	46.1	360.0		86,200	54.6	368.6	73,100	215
220	32.6	334.3	34,000	96,300	43.7	354.7		83,100	52.6	364.8	70,300	220
225	29.2	325.4	31,700	93,000	41.2	349.0		80,200	50.4	360.6	67,700	225
230	25.4	315.1	29,500	89,800	38.5	342.7		77,300	48.2	356.0	65,100	230
235	21.0	302.6	27,300	86,800	35.7	335.7		74,600	45.9	351.1	62,700	235
240	15.3	285.9	25,000	83,700	32.7	327.9		72,000	43.5	345.8	60,400	240
245	2.2	246.7	22,200	80,500	29.3	319.1		69,500	40.9	340.0	58,100	245
250					25.6	308.8		67,000	38.3	333.6	56,000	250
255					21.2	296.4		64,600	35.4	326.6	53,900	255
260					15.5	279.9		62,300	32.4	318.7	51,900	260
265					4.1	245.6		59,700	29.0	309.8	49,900	265
270									25.2	299.4	48,000	270
275									20.7	286.6	46,100	275
280									14.8	269.5	44,200	280

# MLC650 VPC-MAX S-1

ASME B30.5

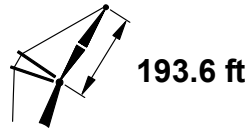
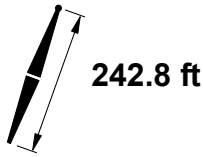

ft	85°				83°				80°				ft
	ft	lb	lb	lb	ft	lb	lb	lb	ft	lb	lb	lb	
85	74.6	437.8	286,900	311,800									85
90	73.1	436.2	266,600	311,800									90
95	71.5	434.5	248,500	311,300									95
100	69.9	432.6	232,400	310,500	72.6	434.7	214,800	309,000					100
105	68.3	430.6	217,800	309,400	71.0	433.0	201,200	304,300					105
110	66.7	428.4	204,600	299,300	69.4	431.0	188,800	287,500					110
115	65.1	426.0	192,600	283,500	67.8	428.9	177,500	272,200					115
120	63.4	423.5	181,700	269,100	66.2	426.7	167,200	258,300					120
125	61.7	420.7	171,600	255,800	64.6	424.2	157,800	245,500	68.7	428.0	137,200	230,100	125
130	60.0	417.8	162,300	243,700	62.9	421.6	149,100	233,800	67.0	425.8	129,300	219,000	130
135	58.3	414.6	153,800	232,500	61.2	418.8	141,000	223,000	65.4	423.5	122,100	208,800	135
140	56.5	411.3	145,800	222,100	59.5	415.8	133,600	212,900	63.8	421.0	115,300	199,300	140
145	54.7	407.7	138,500	212,500	57.7	412.6	126,700	203,600	62.1	418.2	109,100	190,500	145
150	52.8	403.8	131,600	203,500	55.9	409.2	120,200	195,000	60.4	415.3	103,200	182,300	150
155	50.9	399.7	125,100	195,100	54.1	405.5	114,200	186,900	58.6	412.2	97,800	174,600	155
160	48.9	395.3	119,100	187,300	52.2	401.6	108,500	179,400	56.8	408.9	92,700	167,500	160
165	46.9	390.6	113,400	180,000	50.3	397.4	103,200	172,300	55.0	405.4	87,900	160,800	165
170	44.7	385.5	108,100	173,100	48.3	392.9	98,200	165,600	53.2	401.6	83,300	154,500	170
175	42.6	380.0	103,000	166,600	46.2	388.0	93,400	159,400	51.3	397.5	79,100	148,600	175
180	40.3	374.0	98,300	160,500	44.1	382.8	88,900	153,400	49.3	393.2	75,000	143,000	180
185	37.8	367.6	93,700	154,700	41.8	377.2	84,700	147,800	47.3	388.5	71,200	137,700	185
190	35.3	360.5	89,400	149,200	39.5	371.1	80,700	142,600	45.2	383.5	67,600	132,700	190
195	32.5	352.7	85,300	144,000	37.1	364.4	76,800	137,500	43.0	378.1	64,100	127,900	195
200	29.5	343.9	81,400	139,000	34.4	357.1	73,200	132,800	40.7	372.2	60,800	123,400	200
205	26.2	333.9	77,600	134,300	31.6	349.0	69,700	128,200	38.3	365.9	57,700	119,100	205
210	22.4	322.2	74,000	129,800	28.5	339.9	66,300	123,900	35.8	358.9	54,700	115,000	210
215	17.9	307.5	70,400	125,400	25.1	329.5	63,100	119,700	33.1	351.3	51,800	111,100	215
220	11.4	286.4	66,800	121,200	21.1	317.0	59,900	115,700	30.2	342.7	49,000	107,400	220
225					16.2	300.9	56,800	111,900	26.9	333.0	46,300	103,800	225
230					8.3	275.0	53,500	108,100	23.3	321.7	43,700	100,400	230
235									18.9	307.7	41,100	97,000	235
240									13.0	288.6	38,500	93,800	240
245													245
250													250
255													255
260													260
265													265
270													270
275													275
280													280
290													290
300													300

# MLC650 VPC-MAX S-1

ASME B30.5

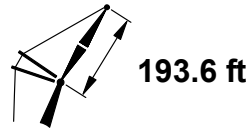
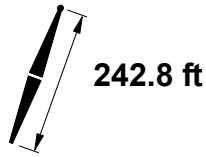

ft	75°				70°			65°			ft
	°	ft	lb	lb	°	ft	lb	°	ft	lb	
85											85
90											90
95											95
100											100
105											105
110											110
115											115
120											120
125											125
130											130
135											135
140											140
145											145
150											150
155											155
160	64.0	416.4	66,600	148,000							160
165	62.3	413.8	62,600	141,900							165
170	60.6	410.9	58,900	136,200							170
175	58.9	407.8	55,400	130,900							175
180	57.1	404.5	52,100	125,800							180
185	55.3	401.0	48,900	121,000							185
190	53.4	397.2	45,900	116,500							190
195	51.5	393.2	43,100	112,100	58.9	401.3	96,700				195
200	49.6	388.9	40,400	108,100	57.1	398.0	93,000				200
205	47.6	384.3	37,800	104,200	55.3	394.5	89,600				205
210	45.5	379.3	35,300	100,500	53.5	390.7	86,200				210
215	43.3	374.0	33,000	96,900	51.6	386.7	83,000				215
220	41.0	368.2	30,700	93,600	49.6	382.4	80,000				220
225	38.7	361.9	28,500	90,300	47.6	377.8	77,100				225
230	36.1	355.0	26,400	87,300	45.5	372.8	74,300	53.3	381.9	61,800	230
235	33.5	347.5	24,400	84,300	43.4	367.5	71,700	51.4	377.9	59,400	235
240	30.6	339.1	22,400	81,400	41.1	361.7	69,100	49.4	373.6	57,200	240
245	27.4	329.5	20,500	78,700	38.7	355.5	66,700	47.4	368.9	55,000	245
250	23.8	318.4		76,000	36.2	348.6	64,300	45.3	363.9	52,900	250
255	19.5	304.9		73,400	33.6	341.1	62,000	43.2	358.6	50,800	255
260	14.0	286.8		70,800	30.7	332.7	59,800	40.9	352.7	48,900	260
265					27.5	323.2	57,700	38.5	346.4	47,000	265
270					23.9	312.2	55,600	36.0	339.5	45,200	270
275					19.7	298.8	53,600	33.3	331.9	43,400	275
280					14.2	280.9	51,500	30.4	323.4	41,700	280
290								23.5	302.6	38,400	290
300								13.5	270.3	35,100	300

# MLC650 VPC-MAX S-1

ASME B30.5

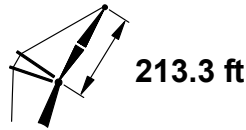
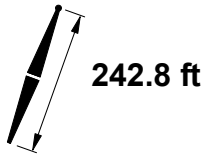

ft	85°				83°				80°				ft
	ft	lb	lb	lb	ft	lb	lb	lb	ft	lb	lb	lb	
90	74.7	456.9	263,300	267,400									90
95	73.3	455.3	245,200	267,400									95
100	71.9	453.6	229,100	267,100									100
105	70.4	451.8	214,600	266,600	72.8	453.8	197,600	264,800					105
110	69.0	449.8	201,400	265,900	71.4	452.1	185,300	264,800					110
115	67.5	447.7	189,500	264,700	70.0	450.2	174,000	264,800					115
120	66.1	445.5	178,500	264,300	68.5	448.2	163,800	254,900					120
125	64.6	443.0	168,500	252,800	67.1	446.0	154,400	242,300					125
130	63.1	440.4	159,200	240,700	65.6	443.7	145,700	230,600	69.3	447.2	125,500	215,600	130
135	61.5	437.7	150,700	229,600	64.1	441.2	137,700	219,900	67.8	445.1	118,300	205,400	135
140	60.0	434.7	142,800	219,200	62.6	438.6	130,300	209,900	66.4	442.9	111,600	196,000	140
145	58.4	431.6	135,400	209,700	61.0	435.8	123,400	200,700	64.9	440.5	105,400	187,300	145
150	56.8	428.3	128,600	200,800	59.5	432.8	117,000	192,100	63.4	437.9	99,600	179,100	150
155	55.1	424.8	122,200	192,400	57.9	429.6	110,900	184,000	61.8	435.2	94,200	171,500	155
160	53.4	421.0	116,200	184,700	56.3	426.2	105,300	176,500	60.3	432.3	89,100	164,500	160
165	51.7	417.0	110,500	177,400	54.6	422.6	100,000	169,500	58.7	429.2	84,400	157,800	165
170	50.0	412.8	105,200	170,500	52.9	418.8	95,100	162,900	57.1	425.9	79,900	151,500	170
175	48.1	408.2	100,200	164,000	51.2	414.7	90,400	156,700	55.5	422.4	75,600	145,700	175
180	46.3	403.4	95,500	158,000	49.4	410.4	85,900	150,800	53.8	418.7	71,600	140,100	180
185	44.4	398.2	91,000	152,200	47.6	405.8	81,700	145,200	52.1	414.8	67,900	134,900	185
190	42.3	392.7	86,800	146,800	45.7	400.8	77,800	140,000	50.3	410.6	64,300	129,900	190
195	40.3	386.8	82,700	141,600	43.7	395.6	74,000	135,000	48.5	406.1	60,900	125,200	195
200	38.1	380.4	78,900	136,700	41.7	389.9	70,400	130,300	46.7	401.4	57,600	120,700	200
205	35.8	373.4	75,200	132,000	39.6	383.8	66,900	125,800	44.7	396.3	54,500	116,500	205
210	33.3	365.8	71,700	127,600	37.4	377.3	63,700	121,500	42.8	390.8	51,600	112,400	210
215	30.7	357.5	68,300	123,300	35.0	370.1	60,500	117,400	40.7	385.0	48,800	108,600	215
220	27.9	348.1	65,100	119,300	32.5	362.3	57,500	113,500	38.5	378.7	46,100	104,900	220
225	24.7	337.4	62,000	115,400	29.9	353.7	54,600	109,800	36.3	371.8	43,500	101,400	225
230	21.1	324.9	58,900	111,600	26.9	343.9	51,800	106,200	33.8	364.4	41,000	98,000	230
235	16.6	309.1	55,900	108,000	23.6	332.7	49,100	102,700	31.3	356.2	38,600	94,700	235
240	10.3	286.2	52,900	104,500	19.8	319.4	46,400	99,400	28.5	347.0	36,200	91,600	240
245					15.0	302.1	43,700	96,100	25.4	336.7	34,000	88,600	245
250					7.1	273.3	40,900	92,900	21.8	324.5	31,700	85,700	250
255									17.6	309.6	29,500	82,900	255
260									11.9	288.9	27,300	80,100	260
265													265
270													270
275													275
280													280
290													290
300													300
310													310
320													320

# MLC650 VPC-MAX S-1

ASME B30.5

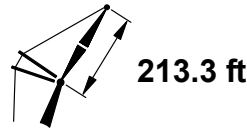
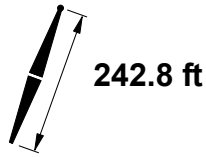

ft	75°				70°			65°			ft
	°	ft	lb	lb	ft	lb	ft	lb	ft		
90										90	
95										95	
100										100	
105										105	
110										110	
115										115	
120										120	
125										125	
130										130	
135										135	
140										140	
145										145	
150										150	
155										155	
160										160	
165										165	
170	63.6	433.4	54,900	132,900						170	
175	62.0	430.7	51,400	127,600						175	
180	60.5	427.8	48,100	122,600						180	
185	58.9	424.8	45,000	117,800						185	
190	57.3	421.5	42,100	113,300						190	
195	55.7	418.0	39,300	109,100						195	
200	54.0	414.4	36,600	105,000						200	
205	52.3	410.5	34,100	101,200	59.0	418.2	86,300			205	
210	50.6	406.3	31,700	97,500	57.4	415.0	83,000			210	
215	48.8	401.9	29,400	94,000	55.7	411.5	79,800			215	
220	46.9	397.1	27,200	90,700	54.1	407.8	76,800			220	
225	45.0	392.1	25,000	87,500	52.4	403.9	74,000			225	
230	43.0	386.7	23,000	84,500	50.6	399.8	71,300			230	
235	41.0	380.9	21,000	81,600	48.8	395.4	68,600			235	
240	38.8	374.7		78,800	47.0	390.7	66,100	53.9	399.1	53,900	240
245	36.6	367.9		76,100	45.1	385.6	63,700	52.2	395.2	51,700	245
250	34.2	360.6		73,500	43.1	380.2	61,400	50.4	391.0	49,700	250
255	31.6	352.5		71,000	41.0	374.5	59,200	48.6	386.5	47,700	255
260	28.9	343.5		68,600	38.9	368.2	57,000	46.8	381.8	45,800	260
265	25.8	333.3		66,200	36.6	361.5	54,900	44.9	376.7	43,900	265
270	22.3	321.4		63,900	34.3	354.2	52,900	42.9	371.3	42,200	270
275	18.2	307.0		61,700	31.7	346.1	51,000	40.8	365.5	40,400	275
280	12.8	287.4		59,500	28.9	337.1	49,100	38.7	359.2	38,800	280
290					22.5	315.2	45,500	34.0	345.0	35,600	290
300					13.0	281.5	41,900	28.7	327.8	32,600	300
310								22.1	305.5	29,700	310
320								12.4	270.7	26,900	320

# MLC650 VPC-MAX S-1

ASME B30.5

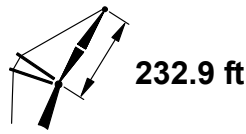
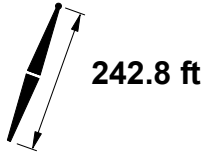

ft	85°				83°				80°				ft
	ft	lb	lb	lb	ft	lb	lb	lb	ft	lb	lb	lb	
95	74.7	475.9	239,400	243,600									95
100	73.5	474.4	223,400	243,500									100
105	72.2	472.7	208,900	243,100									105
110	70.9	470.9	195,800	242,600									110
115	69.5	469.0	183,900	241,900	71.8	471.2	168,000	241,000					115
120	68.2	467.0	173,000	241,000	70.4	469.4	157,800	241,000					120
125	66.9	464.8	163,000	239,900	69.1	467.4	148,500	237,200					125
130	65.5	462.5	153,800	236,100	67.8	465.3	139,900	225,700					130
135	64.1	460.0	145,300	225,000	66.4	463.1	131,900	215,000	69.8	466.4	111,900	200,100	135
140	62.8	457.4	137,500	214,700	65.1	460.7	124,500	205,100	68.5	464.4	105,300	190,800	140
145	61.3	454.6	130,200	205,200	63.7	458.2	117,700	196,000	67.1	462.2	99,100	182,200	145
150	59.9	451.7	123,400	196,400	62.3	455.6	111,300	187,400	65.8	459.9	93,400	174,100	150
155	58.5	448.6	117,000	188,100	60.9	452.7	105,400	179,500	64.4	457.5	88,100	166,600	155
160	57.0	445.3	111,000	180,400	59.5	449.7	99,800	172,000	63.0	454.9	83,000	159,600	160
165	55.5	441.8	105,400	173,100	58.0	446.6	94,500	165,000	61.6	452.2	78,300	153,000	165
170	54.0	438.1	100,200	166,300	56.5	443.2	89,600	158,500	60.2	449.3	73,900	146,800	170
175	52.4	434.2	95,200	159,900	55.0	439.7	85,000	152,300	58.8	446.2	69,700	141,000	175
180	50.8	430.1	90,500	153,900	53.5	435.9	80,600	146,500	57.3	442.9	65,800	135,500	180
185	49.2	425.8	86,100	148,200	51.9	432.0	76,400	141,000	55.8	439.5	62,100	130,300	185
190	47.5	421.1	81,900	142,800	50.3	427.8	72,500	135,800	54.3	435.8	58,600	125,400	190
195	45.8	416.2	77,900	137,600	48.7	423.3	68,800	130,800	52.7	432.0	55,200	120,700	195
200	44.0	411.0	74,100	132,800	47.0	418.6	65,200	126,100	51.1	427.9	52,000	116,300	200
205	42.2	405.5	70,500	128,100	45.2	413.6	61,800	121,700	49.5	423.6	49,000	112,100	205
210	40.3	399.5	67,000	123,700	43.5	408.3	58,600	117,400	47.9	419.0	46,100	108,100	210
215	38.3	393.2	63,700	119,500	41.6	402.7	55,500	113,400	46.1	414.2	43,300	104,300	215
220	36.2	386.3	60,500	115,500	39.7	396.6	52,600	109,500	44.4	409.1	40,700	100,600	220
225	34.0	378.9	57,500	111,700	37.6	390.1	49,700	105,800	42.6	403.6	38,100	97,100	225
230	31.7	370.8	54,600	108,000	35.5	383.1	47,000	102,300	40.7	397.7	35,700	93,800	230
235	29.2	361.9	51,800	104,500	33.3	375.5	44,400	98,900	38.7	391.5	33,400	90,600	235
240	26.4	352.0	49,100	101,100	30.9	367.2	41,900	95,700	36.6	384.7	31,100	87,600	240
245	23.4	340.7	46,400	97,800	28.3	358.0	39,500	92,500	34.5	377.4	29,000	84,600	245
250	19.9	327.3	43,900	94,700	25.5	347.6	37,100	89,500	32.1	369.5	26,900	81,800	250
255	15.6	310.5	41,300	91,600	22.3	335.7	34,800	86,600	29.7	360.8	24,800	79,100	255
260	9.3	285.6	38,700	88,600	18.6	321.5	32,500	83,800	27.0	351.1	22,800	76,400	260
265					13.9	303.1	30,200	81,000	24.0	340.0	20,900	73,900	265
270					5.9	270.8	27,700	78,200	20.6	327.2		71,400	270
275									16.5	311.3		69,000	275
280									10.9	288.9		66,600	280
290													290
300													300
310													310
320													320
330													330



# MLC650 VPC-MAX S-1

ASME B30.5

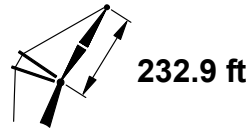
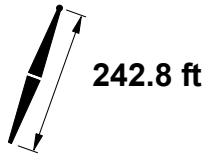

ft	75°				70°			65°			ft
	°	ft	lb	lb	°	ft	lb	°	ft	lb	
95											95
100											100
105											105
110											110
115											115
120											120
125											125
130											130
135											135
140											140
145											145
150											150
155											155
160											160
165											165
170											170
175	64.6	453.0	44,700	122,300							175
180	63.2	450.4	41,500	117,400							180
185	61.8	447.7	38,500	112,700							185
190	60.4	444.8	35,600	108,300							190
195	59.0	441.7	32,900	104,100							195
200	57.5	438.5	30,300	100,100							200
205	56.0	435.1	27,800	96,300							205
210	54.5	431.5	25,400	92,700							210
215	52.9	427.6	23,200	89,200	59.0	435.2	74,600				215
220	51.4	423.6	21,000	86,000	57.5	432.0	71,600				220
225	49.7	419.3		82,800	56.1	428.5	68,800				225
230	48.1	414.8		79,800	54.5	424.9	66,200				230
235	46.4	410.0		77,000	53.0	421.1	63,600				235
240	44.6	404.9		74,200	51.4	417.1	61,100				240
245	42.8	399.5		71,600	49.8	412.8	58,800				245
250	40.9	393.7		69,000	48.1	408.3	56,500	54.4	416.2	44,400	250
255	39.0	387.4		66,600	46.4	403.5	54,300	52.8	412.4	42,400	255
260	36.9	380.8		64,200	44.7	398.4	52,200	51.3	408.3	40,600	260
265	34.8	373.6		61,900	42.9	393.0	50,200	49.6	404.0	38,800	265
270	32.5	365.7		59,700	41.0	387.2	48,200	48.0	399.5	37,100	270
275	30.0	357.1		57,600	39.0	381.0	46,400	46.3	394.6	35,400	275
280	27.4	347.5		55,600	37.0	374.3	44,500	44.5	389.5	33,800	280
290	21.1	324.1		51,600	32.5	359.3	41,100	40.8	378.2	30,700	290
300	11.8	287.7		47,800	27.5	341.2	37,800	36.8	365.3	27,900	300
310					21.2	317.9	34,600	32.3	350.1	25,100	310
320					12.0	281.9	31,600	27.2	331.8	22,500	320
330								20.9	308.2	20,000	330