

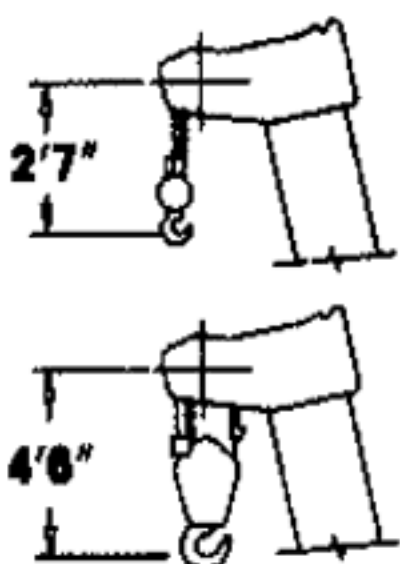

RT528C

Rough terrain hydraulic crane/28 ft.-70 ft. boom

RANGE DIAGRAM (UNLADEN BOOM)

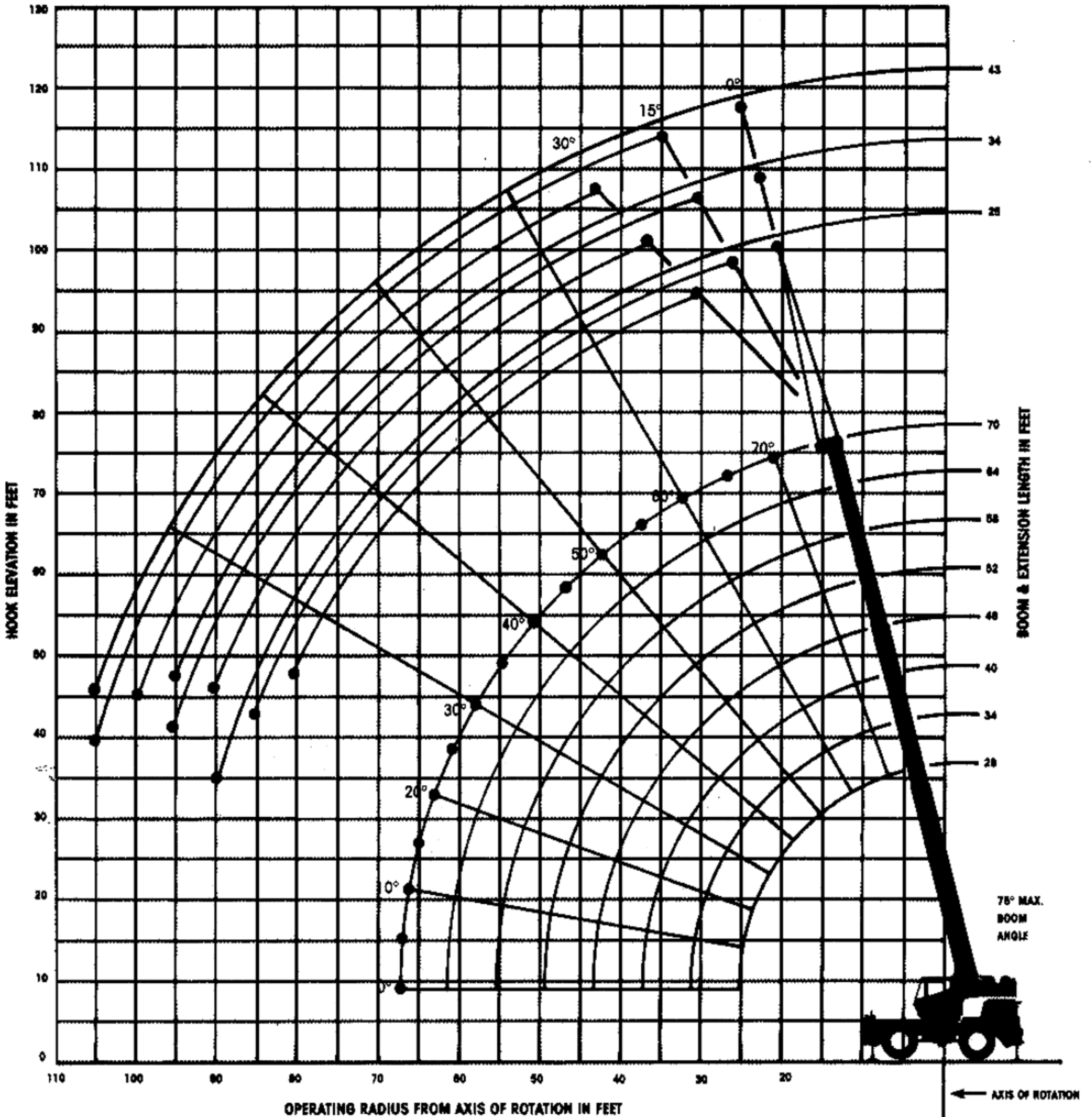

DIMENSIONS ARE FOR LARGEST GROVE FURNISHED HOOK BLOCK AND HEADACHE BALL, WITH ANTI-TWO BLOCK ACTIVATED.

NOTES FOR LIFTING CAPACITIES

- All rated loads have been tested to and meet minimum requirements of SAE J1063 OCT80 - Cantilevered Boom Crane Structures - Method of Test, and do not exceed 85% of the tipping load on outriggers (75% of the tipping load on rubber) as determined by SAE J765 OCT80 Crane Stability Test Code.
- This chart is intended as a guide only. The individual crane's load chart operating instructions and other instruction plates give details of the conditions under which the crane may be operated safely. ALL OF THESE INSTRUCTIONS MUST BE READ AND UNDERSTOOD PRIOR TO OPERATING THE CRANE.
- Capacities given do not include the weight of hookblocks, slings, auxiliary lifting equipment and load handling devices. Their weights MUST be added to the load to be lifted. When more than minimum required reeving is used, the additional rope weight shall be considered part of the load.
- Capacities appearing above the bold line are based on structural strength and tipping should not be relied upon as a capacity limitation.
- All capacities are for crane on firm, level surface. It may be necessary to have structural supports under the outrigger floats or tires to spread the load to a larger bearing surface.
- When either boom length or radius or both are between values listed, the smallest load shown at either the next larger radius or boom length shall be used.
- For outrigger operation, ALL outriggers shall be fully extended with tires raised free of ground before raising the boom or lifting loads.
- Tires shall be inflated to the recommended pressure before lifting on rubber.
- Unless otherwise stated, capacities are with powered boom sections equally extended.
- Defined Arc - 6° on either side of longitudinal centerline of machine.
- With tele-boom extension in working position and main boom length greater than 70 ft., boom angle must not be less than 30°.

Constant improvement and engineering progress makes it necessary that we reserve the right to make specification, equipment, and price changes without notice. Illustrations shown may include optional equipment and accessories and may not include all standard equipment.

North and South America, U.S.S.R., Far East, Australasia
GROVE MANUFACTURING COMPANY
 Box 21 ■ Shady Grove ■ Pennsylvania 17256
 (717) 597-8121 ■ telex: 842308 ■ fax: (717) 597-4062

Europe, Africa, Middle East, Indian Sub-continent
GROVE
 Telford Rd. ■ Bloxster ■ Oxfordshire OX6 0TZ
 (0869) 246800 ■ telex: 837447 ■ fax: 0869-246965

FORM NO.: LC-RT528C-Dom. 489-10M PRINTED IN U.S.A.

ON RUBBER CAPACITIES WITH 20.5 x 25 TIRES STATIONARY CAPACITIES - 360°

Radius in Feet	Main Boom Length in Feet							
	28	34	40	46	52	58	64	70
10	26,200 (64)	26,200 (69)						
12	19,350 (59.5)	19,350 (65.5)	16,000 (70)					
15	13,200 (51.5)	13,200 (59.5)	13,200 (66)	13,200 (69)				
20	7,910 (36.5)	7,910 (49)	7,910 (57)	7,910 (62)	7,910 (66)	7,400 (69.5)		
25	6,060 (6)	6,060 (36)	6,060 (47.5)	6,060 (54.5)	6,060 (60)	6,060 (64)	6,060 (67)	6,060 (69.5)
30		3,600 (15.5)	3,600 (36.5)	3,600 (46.5)	3,600 (53)	3,600 (58)	3,600 (62)	3,600 (65)
35			2,610 (20)	2,610 (36.5)	2,610 (48.5)	2,610 (51.5)	2,610 (56.5)	2,610 (60)
40				1,890 (23)	1,890 (36.5)	1,890 (45)	1,890 (50.5)	1,890 (55)
45					1,340 (25)	1,340 (37)	1,340 (44.5)	1,340 (49.5)
50						910 (26.5)	910 (37)	910 (43.5)

A6-829-009073

STATIONARY CAPACITIES - DEFINED ARC OVER FRONT

Radius in Feet	Main Boom Length in Feet							
	28	34	40	46	52	58	64	70
10	28,650 (64)	25,900 (69)						
12	24,950 (59.5)	24,950 (65.5)	21,000 (70)					
15	20,900 (51.5)	20,900 (59.5)	20,900 (65)	16,500 (69)				
20	14,900 (36.5)	14,900 (49)	14,900 (57)	12,200 (62)	12,200 (66)	12,200 (69.5)		
25	9,900 (6)	9,900 (36)	9,900 (47.5)	9,900 (54.5)	9,400 (60)	9,400 (64)	9,400 (67)	9,400 (69.5)
30		7,350 (15.5)	7,350 (36.5)	7,350 (46.5)	7,000 (53)	7,000 (58)	7,000 (62)	7,000 (65)
35			5,660 (20)	5,660 (36.5)	5,660 (48.5)	5,660 (51.5)	5,660 (56.5)	5,660 (60)
40				4,450 (23)	4,450 (36.5)	4,450 (45)	4,450 (50.5)	4,450 (55)
45					3,550 (25)	3,550 (37)	3,550 (44.5)	3,550 (49.5)
50						2,850 (26.5)	2,850 (37)	2,850 (43.5)
55						2,290 (3.5)	2,290 (28)	2,290 (37)
60							1,840 (13)	1,840 (28.5)
65								1,460 (15.5)

A6-829-009074

PICK & CARRY CAPACITIES (UP TO 2.5 MPH) - BOOM CENTERED OVER FRONT

Radius in Feet	Main Boom Length in Feet							
	28	34	40	46	52	58	64	70
10	33,800 (64)							
12	29,000 (59.5)							
15	23,600 (51.5)	23,600 (59.5)	23,600 (65)	23,600 (69)				
20	14,900 (36.5)	14,900 (49)	14,900 (57)	14,900 (62)	12,200 (66)	12,200 (69.5)		
25	9,900 (6)	9,900 (36)	9,900 (47.5)	9,900 (54.5)	9,900 (60)	9,400 (64)	9,400 (67)	
30		7,180 (15.5)	7,180 (36.5)	7,180 (46.5)	7,180 (53)	7,180 (58)	7,000 (62)	7,000 (65)
35			5,660 (20)	5,660 (36.5)	5,660 (48.5)	5,660 (51.5)	5,660 (56.5)	5,660 (60)
40				4,450 (23)	4,450 (36.5)	4,450 (45)	4,450 (50.5)	4,450 (55)
45					3,550 (25)	3,550 (37)	3,550 (44.5)	3,550 (49.5)
50						2,850 (26.5)	2,850 (37)	2,850 (43.5)
55						2,290 (3.5)	2,290 (28)	2,290 (37)
60							1,840 (13)	1,840 (28.5)
65								1,460 (15.5)

NOTE: Boom angles are in degrees.

A6-829-009075

	No Load Stability Data		Main Boom 70 ft.
	Min. boom angle (deg.) for indicated length	Max. boom length (ft.) at 0 deg. boom angle	
Front (No load)			0
360 Deg. (No load)			70
	Min. boom angle (deg.) for indicated length		34
	Max. boom length (ft.) at 0 deg. boom angle		52

**25 FT. BOOM EXTENSION
ON OUTRIGGERS - 360°**

Radius in Feet	Boom Angle Ref.	Cap. (lbs.)
25	75.0	12,500
30	71.5	10,700
35	68.0	9,230
40	65.0	8,280
45	61.5	7,340
50	58.0	6,720
55	54.0	6,430
60	50.0	6,070
65	46.0	5,180
70	41.5	4,440
75	36.5	3,820
80	30.5	3,280
85	23.5	2,810
90	12.5	2,400

A6-829-008673

*This capacity is based upon the maximum boom angle.

**WEIGHT REDUCTIONS FOR
LOAD HANDLING DEVICES**

25 FT. BOOM EXTENSION

†Stowed -	402 lbs.
†Erected -	1,279 lbs.

25 FT. - 43 FT. TELE. EXTENSION

†Stowed -	725 lbs.
†Erected (Retracted) -	3,350 lbs.
†Erected (Extended) -	4,262 lbs.

†Reduction of main boom capacities.

HOOKBLOCKS:

12 Ton, 1 Sheave	360 lbs.
35 Ton, 4 Sheave	600 lbs.
22 Ton, 3 Sheave	455 lbs.
Auxiliary Boom Head	112 lbs.
5 Ton Headache Ball	172 lbs.

**RATED CAPACITIES ON OUTRIGGERS
28 FT. - 70 FT. BOOM
ON OUTRIGGERS - 360°**

Radius in Feet	Main Boom Length in Feet								
	28	34	40	46	52	58	64	70	
10.0	56,000 (64)	36,000 (69)	36,000 (73)						
12.0	40,000 (59.5)	36,000 (65.5)	36,000 (70)	35,000 (73)					
15.0	34,000 (51.5)	31,000 (59.5)	30,950 (65)	30,300 (69)	29,750 (72)	29,150 (74.5)			
20.0	23,200 (36.5)	23,200 (49)	23,200 (57)	23,200 (62)	23,000 (66)	22,600 (69.5)	22,250 (72)	20,500 (74)	
25.0	17,950 (6)	17,950 (36)	17,950 (47.5)	17,950 (54.5)	17,950 (60)	17,950 (64)	17,950 (67)	17,650 (69.5)	
30.0		15,350 (15.5)	15,350 (36.5)	15,350 (46.5)	15,350 (53)	15,150 (58)	14,950 (62)	14,750 (65)	
35.0			12,850 (20)	12,850 (36.5)	12,850 (45.5)	12,800 (51.5)	12,650 (56.5)	12,500 (60)	
40.0				10,750 (23)	10,750 (36.5)	10,750 (45)	10,750 (50.5)	10,750 (55)	
45.0					9,020 (25)	9,020 (37)	9,020 (44.5)	9,020 (49.5)	
50.0						7,420 (26.5)	7,420 (37)	7,420 (43.5)	
55.0						6,170 (3.5)	6,170 (28)	6,170 (37)	
60.0							5,170 (13)	5,170 (28.5)	
65.0								4,350 (15.5)	
Minimum boom angle (deg.) for indicated length (no load)									0
Maximum boom length (ft.) at 0 deg. boom angle (no load)									70

NOTE: Boom angles are in degrees.

A6-829-008639

25 FT. - 43 FT. TELE. EXTENSION ON OUTRIGGERS - 360°

Radius in Feet	25 ft. LENGTH						34 ft. LENGTH						43 ft. LENGTH					
	0° OFFSET		15° OFFSET		30° OFFSET		0° OFFSET		15° OFFSET		30° OFFSET		0° OFFSET		15° OFFSET		30° OFFSET	
	Boom Angle Ref. (Deg.)	Cap. lbs.	Boom Angle Ref. (Deg.)	Cap. lbs.	Boom Angle Ref. (Deg.)	Cap. lbs.	Boom Angle Ref. (Deg.)	Cap. lbs.	Boom Angle Ref. (Deg.)	Cap. lbs.	Boom Angle Ref. (Deg.)	Cap. lbs.	Boom Angle Ref. (Deg.)	Cap. lbs.	Boom Angle Ref. (Deg.)	Cap. lbs.	Boom Angle Ref. (Deg.)	Cap. lbs.
25	75.0	12,500	75.0	7,300			75.0	7,700					75.0	4,500				
30	71.5	10,700	74.0	7,170	75.0	5,250	73.0	7,180	75.0	4,900			74.0	4,430				
35	68.0	9,230	70.5	6,490	73.0	5,080	70.0	6,110	73.5	4,790			71.5	3,960	75.0	2,800		
40	65.0	8,280	67.5	5,900	69.5	4,730	67.0	5,370	70.5	4,360	75.0	3,200	68.5	3,610	74.0	2,770		
45	61.5	7,340	64.0	5,460	66.0	4,440	63.5	4,870	67.5	4,020	71.5	2,900	66.0	3,360	71.0	2,640	75.0	2,200
50	58.0	6,720	60.5	5,210	62.5	4,270	60.0	4,500	64.5	3,730	68.0	2,590	63.5	3,140	68.5	2,520	73.0	2,150
55	54.0	6,430	56.5	5,030	58.5	4,130	56.5	4,070	61.5	3,400	64.5	2,360	60.5	2,920	65.5	2,400	69.5	2,080
60	50.0	5,510	53.0	4,970	54.5	3,980	53.0	3,700	58.0	3,100	61.0	2,220	57.5	2,730	62.5	2,280	66.5	2,020
65	46.0	4,630	48.5	4,630	50.0	3,900	49.5	3,450	54.5	2,830	57.0	2,070	54.5	2,560	59.0	2,170	63.0	1,950
70	41.5	3,890	44.0	3,890	45.5	3,800	45.5	3,310	50.5	2,610	53.0	1,940	51.5	2,360	56.0	2,110	59.5	1,880
75	36.5	3,270	39.0	3,270	40.0	3,270	41.0	3,170	46.5	2,470	48.5	1,880	48.0	2,210	52.5	2,040	56.0	1,810
80	30.5	2,730	33.0	2,730	34.0	2,730	36.5	3,080	42.0	2,410	44.0	1,830	44.5	2,140	49.0	1,980	52.0	1,730
85	23.5	2,270	26.0	2,270			31.5	2,740	37.0	2,370	38.5	1,790	41.0	2,100	45.0	1,940	47.5	1,670
90	12.5	1,860					25.5	2,320	31.5	2,310	32.0	1,770	36.5	2,060	40.5	1,900	43.0	1,620
95							18.5	1,950	24.0	1,950			32.0	2,010	35.5	1,850	37.5	1,570
100													26.5	1,940	30.0	1,780	30.5	1,500
105													19.0	1,690	22.0	1,690		

*This capacity is based upon maximum boom angle.

A6-829-008672



RT528C

Rough terrain hydraulic crane/28 ft.-70 ft. boom

RANGE DIAGRAM (UNLADEN BOOM)

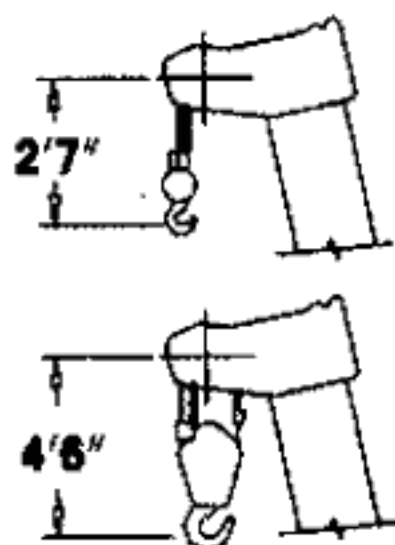
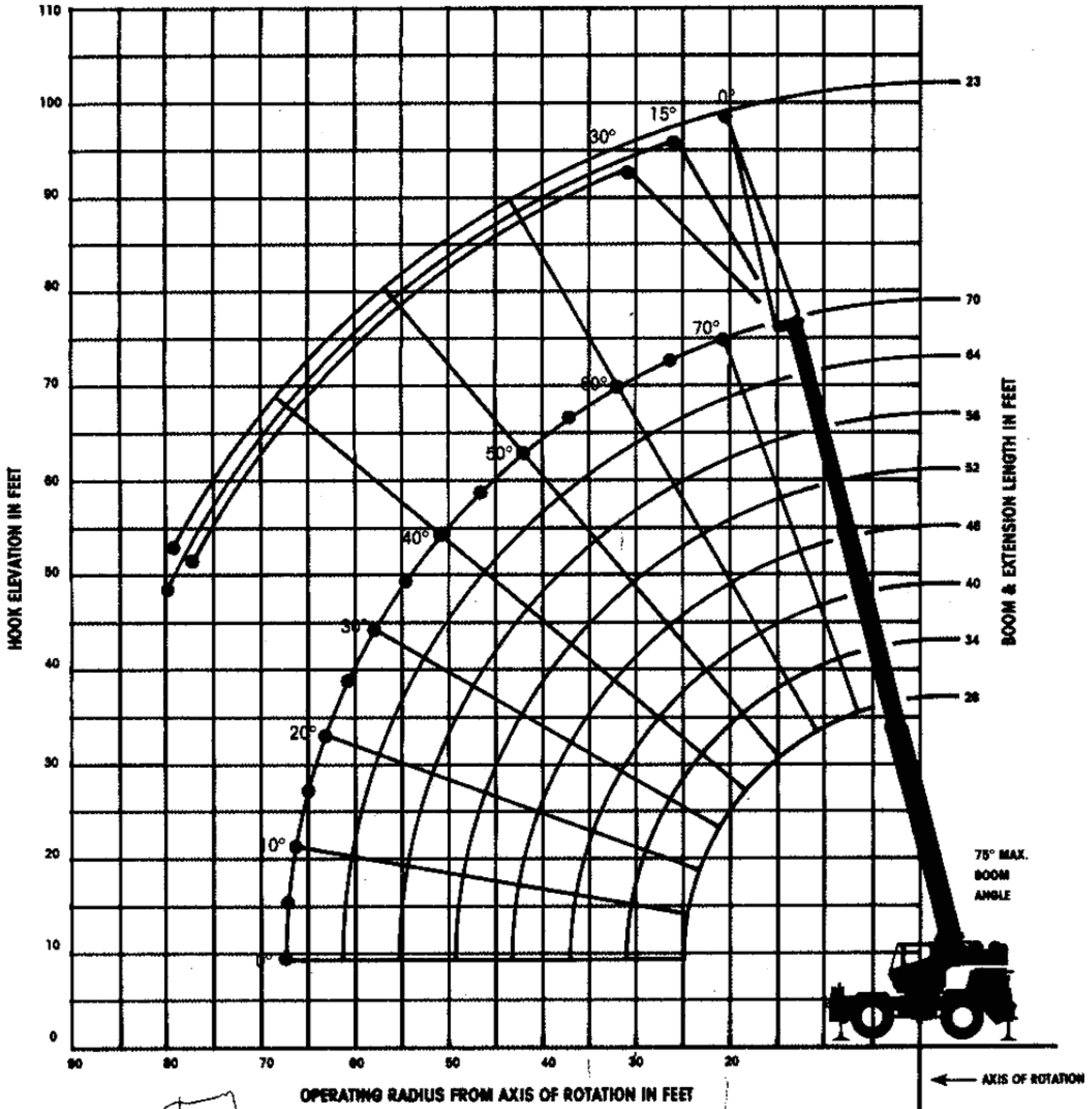

DIMENSIONS ARE FOR LARGEST GROVE FURNISHED HOOK BLOCK AND HEADACHE BALL, WITH ANTI-TWO BLOCK ACTIVATED.

**ON RUBBER CAPACITIES WITH 16.00 x 25 TIRES
STATIONARY CAPACITIES - 360°**

Radius in Feet	Main Boom Length in Feet						
	28	34	40	46	52	58	64
10	22,450 (64)	22,450 (69)					
12	18,350 (59.5)	18,350 (65.5)	16,600 (70)	16,600 (73)			
15	12,500 (51.5)	12,500 (59.5)	12,500 (68)	12,200 (69)	12,200 (72)	12,200 (74.5)	
20	7,410 (36.6)	7,410 (49)	7,410 (57)	7,410 (62)	7,410 (66)	7,410 (69.5)	7,410 (72)
25	4,650 (6)	4,650 (36)	4,650 (47.5)	4,650 (54.5)	4,650 (60)	4,650 (64)	4,650 (67)
30		2,930 (15.5)	2,930 (36.5)	2,930 (46.5)	2,930 (53)	2,930 (58)	2,930 (62)
35			1,740 (20)	1,740 (36.5)	1,740 (45.5)	1,740 (51.5)	1,740 (56.5)
40				880 (23)	880 (36.5)	880 (45)	880 (50.5)

STATIONARY CAPACITIES - DEFINED ARC OVER FRONT

Radius in Feet	Main Boom Length in Feet							
	28	34	40	46	52	58	64	70
10	33,450 (64)	28,550 (69)						
12	28,550 (59.5)	28,550 (65.5)	28,550 (70)	17,100 (73)				
15	23,250 (51.5)	23,250 (59.5)	23,250 (65)	17,100 (69)	13,250 (72)	13,250 (74.5)		
20	14,700 (36.5)	14,700 (49)	14,700 (57)	14,700 (62)	13,250 (66)	13,250 (69.5)	7,900 (72)	
25	10,100 (6)	10,100 (36)	10,100 (47.5)	10,100 (54.5)	10,100 (60)	10,100 (64)	7,900 (67)	
30		7,420 (15.5)	7,420 (36.5)	7,420 (46.5)	7,420 (53)	7,420 (58)	7,400 (62)	7,400 (65)
35			5,610 (20)	5,610 (36.5)	5,610 (45.5)	5,610 (51.5)	5,610 (56.5)	5,610 (60)
40				4,330 (23)	4,330 (36.5)	4,330 (45)	4,330 (50.5)	4,330 (55)
45					3,360 (25)	3,360 (37)	3,360 (44.5)	3,360 (49.5)
50						2,620 (26.5)	2,620 (37)	2,620 (43.5)
55						2,020 (3.5)	2,020 (28)	2,020 (37)
60							1,530 (13)	1,530 (28.5)
65								1,120 (15.5)

**PICK & CARRY CAPACITIES (UP TO 2.5 MPH) -
BOOM CENTERED OVER FRONT**

Radius in Feet	Main Boom Length in Feet							
	28	34	40	46	52	58	64	70
10	31,750 (64)							
12	27,450 (59.5)							
15	22,600 (51.5)	22,600 (59.5)	21,000 (65)					
20	14,700 (36.5)	14,700 (49)	14,700 (57)	14,700 (62)	14,700 (66)			
25	10,100 (6)	10,100 (36)	10,100 (47.5)	10,100 (54.5)	10,100 (60)	9,400 (64)		
30		7,420 (15.5)	7,420 (36.5)	7,420 (46.5)	7,420 (53)	7,400 (58)	7,400 (62)	7,400 (65)
35			5,610 (20)	5,610 (36.5)	5,610 (45.5)	5,610 (51.5)	5,610 (56.5)	5,610 (60)
40				4,330 (23)	4,330 (36.5)	4,330 (45)	4,330 (50.5)	4,330 (55)
45					3,360 (25)	3,360 (37)	3,360 (44.5)	3,360 (49.5)
50						2,620 (26.5)	2,620 (37)	2,620 (43.5)
55						2,020 (3.5)	2,020 (28)	2,020 (37)
60							1,530 (13)	1,530 (28.5)
65								1,120 (15.5)

Note: Boom angles are in degrees.

A6-829-009115 & -009116 & -009117

**23 FT. A-FRAME JIB
(ON OUTRIGGERS - 360°)**

Main Boom Angle (Deg.)	0° OFFSET		15° OFFSET		30° OFFSET	
	Rad. Ref. (ft.)	Cap. lbs.	Rad. Ref. (ft.)	Cap. lbs.	Rad. Ref. (ft.)	Cap. lbs.
75	27.0	12,000	32.5	7,700	35.7	5,070
70	33.3	10,400	38.1	7,000	41.2	4,800
65	40.2	8,500	44.9	6,300	47.8	4,500
60	47.0	7,400	51.3	5,450	54.0	4,300
55	53.2	6,600	57.3	5,000	59.8	4,100
50	59.2	6,100	62.9	4,700	65.1	3,900
45	64.7	5,160	68.0	4,500	69.9	3,800
40	69.6	4,410	72.6	4,010	74.2	3,700
35	74.0	3,840	76.6	3,530	77.9	3,390
30	77.8	3,400	80.1	3,160		

A6-829-008660

**WEIGHT REDUCTIONS FOR
LOAD HANDLING DEVICES**

23 ft. A-FRAME JIB with 28 ft.- 70 ft. Boom	
*Stowed -	381 lbs.
*Erected -	1,950 lbs.

*Reduction of main boom capacities

HOOKBLOCKS:	
12 Ton, 1 Sheave	360 lbs.
35 Ton, 4 Sheave	600 lbs.
22 Ton, 3 Sheave	455 lbs.
Auxiliary Boom Head	112 lbs.
5 Ton Headache Ball	172 lbs.