

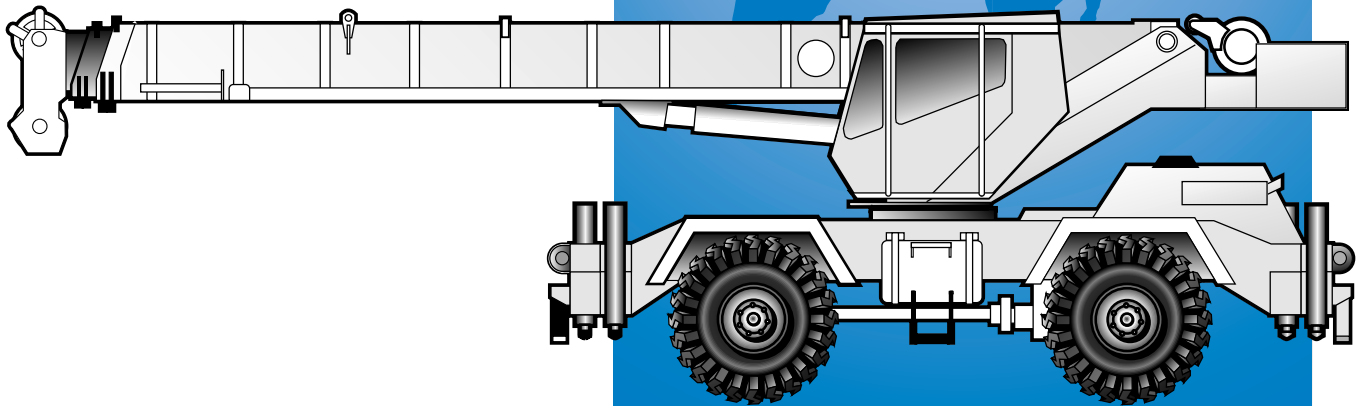

RT522B



Rough Terrain Hydraulic Crane

Dimensions

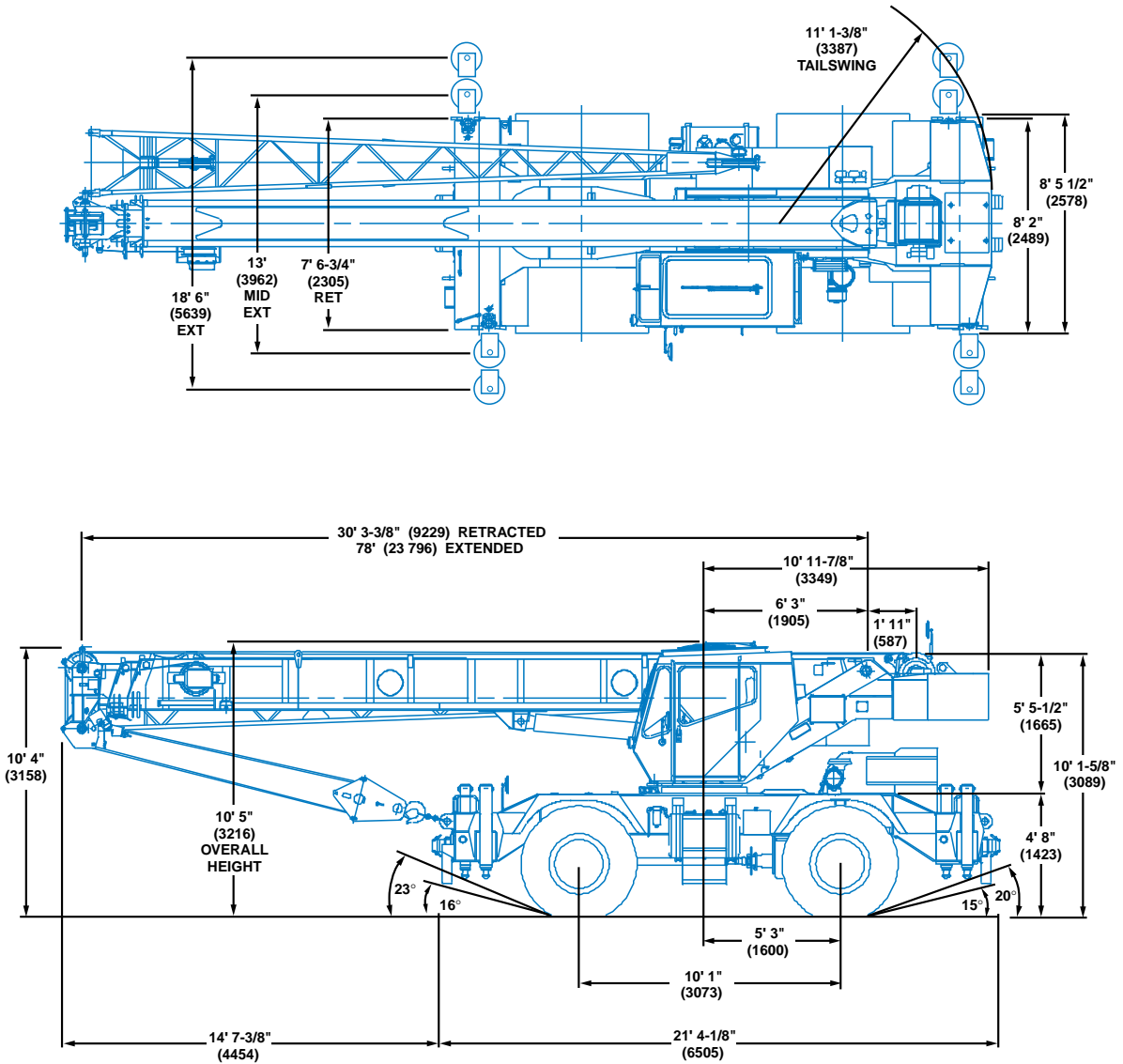

Note: () Reference dimensions in mm

Turning Radius 16.4'

Front Axle Load 21,860 lbs. (9916 kg)

Rear Axle Load 22,788 lbs. (10 336 kg)

Gross Vehicle Weight 44,648 lbs. (20 252 kg)

Working range



30 - 78 ft.
(9.2 - 23.8 m)

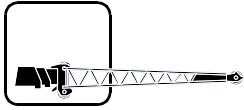

25 ft.
(7.6 m)



5,700 lbs.
(2586 kg)

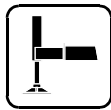

100%



360°

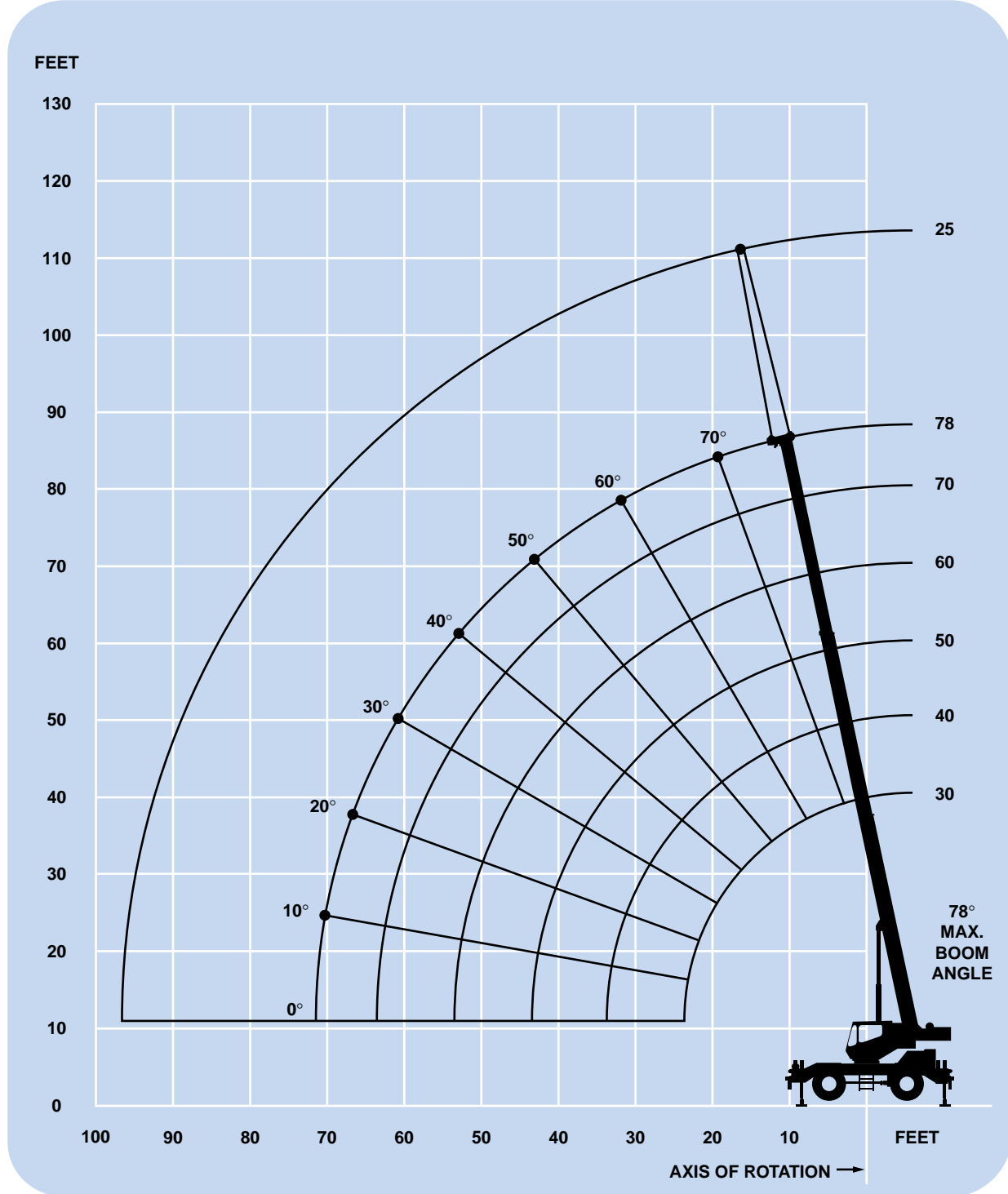

2'-7"

4'-6"

DIMENSIONS ARE FOR LARGEST GROVE FURNISHED HOOK BLOCK AND HEADACHE BALL, WITH ANTI-TWO BLOCK ACTIVATED.

Superstructure specifications

Boom

30 ft. - 78 ft. (9.2 m - 23.8 m) three-section full power boom. Maximum tip height: 84 ft. 9 in. (25.8 m).

Fixed Swingaway Extension

25 ft. (7.6 m) lattice swingaway extension. Non-offsettable. Stows alongside base boom section. Maximum tip height: 108 ft. 11 in. (33.2 m).

Boom Nose

Three steel sheaves mounted on heavy duty permlubed tapered roller bearings with removable pin-type rope guards. Quick reeve type boom nose.

*Optional removable auxiliary boom nose with removable pin type rope guard.

Boom Elevation

One double acting hydraulic cylinder with integral holding valve provides elevation from -3° to +78°.

Load Moment & Anti-Two Block System

Standard load moment and anti two block system with audio-visual warning and control lever lockout. These systems provide electronic display of boom angle, length, radius, tip height, relative load moment, maximum permissible load, load indication and warning of impending two-block condition.

Cab

Full vision, all galvanealed steel fabricated with acoustical lining and tinted safety glass throughout. Deluxe reclining seat incorporates adjustable armrest with hydraulic single-axis controllers. Dash panel incorporates gauges for all engine functions. Other standard features include: cab circulating air fan, sliding side and rear windows, electric windshield wash/wipe, manual skylight wiper, swing horn, fire extinguisher, seat belt, and tachometer.

Swing

Planetary swing with foot applied multi-disc brake. Spring applied, hydraulically released swing brake. One position, plunger type mechanical house lock, and a 360° positive swing lock, both operated from cab. Maximum speed: 3.0 RPM.

Counterweight

5,700 lbs. (2586 kg) integral with superstructure. 773 lbs. (351 kg) slab in place of auxiliary hoist.

Hydraulic System

Two main gear pumps with a combined capacity of 72.0 GPM (272.5 LPM).

Maximum operating pressure: 3500 PSI (241 bar).

Two individual pressure compensated valve banks.

Return line type filter with full flow by-pass protection and service indicator. Replaceable cartridge with micron filtration rating of 5/12/16.

82 gallon (310 L) reservoir.

Remote-mounted oil cooler with thermostatically controlled electric motor driven fan.

System pressure test ports with quick release type fittings for each circuit.

HOIST SPECIFICATIONS

Main and Auxiliary Hoist

Planetary reduction with automatic spring applied multi-disc brake. Grooved drum. Electronic hoist drum rotation indicator and hoist drum cable followers.

Maximum Single Line Pull: 12,148 lbs.
(5510 kg)

Maximum Single Line Speed: 287 FPM
(87 m/min)

Maximum Permissible Line Pull: 9,080 lbs.
(4119 kg)

Rope Diameter: 5/8 in.
(16 mm)

Rope Length: 370 ft.
(113 m)

Maximum Rope Stowage: 370 ft.
(113 m)

**Denotes optional equipment*

Carrier specifications

Chassis

Box section frame fabricated from high-strength, low alloy steel. Integral outrigger housings and front/rear towing and tie down lugs.

Outrigger System

Four hydraulic telescoping single-stage double box beam outriggers with inverted jacks and integral holding valves. Three position setting. All steel fabricated quick release type square outrigger floats, 16.5 in. (419 mm) square.
Maximum outrigger pad load: 38,600 lbs. (17 509 kg)

Outrigger Controls

Controls and crane level indicator located in cab.

Engine

Cummins 4BTA3.9 diesel, aftercooled, turbocharged, 130 bhp (96.7 kW) (Gross) @ 2,500 RPM.
Maximum torque: 360 ft. lbs. (488 Nm) @ 1,500 RPM.

Fuel Tank Capacity

40 gallons (151 L)

Transmission

Full powershift with 6 forward and 6 reverse speeds.
Front axle disconnect for 4 x 2 travel.

Electrical System

12 V - maintenance free battery.

Drive

4 x 4

Steering

Full independent power steering.
Front: Full hydraulic steering wheel controlled.
Rear: Full hydraulic hand lever controlled.
Provides 4 main steering modes: front only, rear only, crab and coordinated. Rear steer indicating gauge.

Axles

Front: Drive/steer with differential and planetary reduction hubs rigid mounted to frame.
Rear: Drive/steer with differential and planetary reduction hubs pivot mounted to frame.

Oscillation Lockouts

Automatic full hydraulic lockouts on rear axle permit oscillation only with boom centered over the front.

Brakes

Full hydraulic split circuit brakes operating on all wheels. Spring-applied, hydraulically released transmission-mounted parking brake.

Tires

17.5 x 25-20PR earthmover type, tubeless.

Lights

Full lighting package including turn indicators, head, tail, brake and hazard warning lights.

Maximum Speed

22 mph (35 kph)

Maximum Gradeability

Infinite (Theoretical based on 17.5 x 25 tires, 78 ft. [23.8 m] boom and 25 ft. [7.6 m] swingaway).

Miscellaneous Standard Equipment

Full width galvanealed steel fenders, dual rear view mirrors, hookblock tiedown, electronic back-up alarm, light package, front stowage well, cold start aid (less canister), cab mounted worklight, engine distress A/V warning.

*Optional Equipment

- * Auxiliary hoist (Dealer installed)
- * Hookblock
- * Headache ball
- * Auxiliary boom nose (Dealer installed)

**Denotes optional equipment*



30 - 78 ft.
(9.2 - 23.8 m)



5,700 lbs.
(2586 kg)



100%



360°



Pounds

25 ft. Ext
& 78 ft.
Boom

Feet	30	40	50	60	70	78	103
10	44,000 (62)	42,850 (70)	39,150 (74.5)	*31,450 (78)			
12	39,300 (57.5)	38,400 (67)	36,100 (72)	31,450 (76)			
15	31,300 (50)	31,300 (62)	31,700 (68.5)	27,850 (73)	25,300 (76)	*16,200 (78)	
20	22,450 (34)	23,050 (53)	23,450 (62)	23,250 (67.5)	21,000 (71.5)	16,200 (74)	*12,500 (78)
25		17,300 (42.5)	17,450 (55)	17,900 (62)	17,500 (67)	13,300 (70)	11,400 (75.5)
30		13,450 (29)	13,700 (47)	14,000 (56.5)	13,800 (62.5)	11,200 (66)	10,200 (72.5)
35			10,500 (38)	10,750 (50)	10,900 (57.5)	9,600 (61.5)	9,500 (69.5)
40			8,590 (26)	8,840 (43)	9,000 (52)	8,330 (57.5)	8,250 (66.5)
45				7,140 (35)	7,290 (46.5)	7,310 (52.5)	7,170 (63.5)
50				5,740 (24)	5,910 (40)	6,050 (47.5)	6,260 (60)
55					4,840 (32.5)	4,990 (42)	5,500 (57)
60					3,970 (22.5)	4,140 (35.5)	4,660 (53)
65						3,440 (27.5)	3,930 (49.5)
70						2,850 (16)	3,320 (45.5)
75							2,800 (41)
80							2,360 (36.5)
85							1,980 (31)
90							1,640 (24)
95							1,340 (14)
Minimum boom angle (deg.) for indicated length							0
Maximum boom length (ft.) at 0 deg. boom angle (no load)							103

NOTE: () Boom angles are in degrees.
* This capacity is based upon maximum boom angle.

Boom Angle	30	40	50	60	70	78
0°	10,950 (23.8)	7,360 (33.8)	5,190 (43.8)	3,740 (53.8)	2,710 (63.8)	2,060 (71.8)

NOTE: () Reference radii in feet.

A6-829-015872



30 - 78 ft.
(9.2 - 23.8 m)



5,700 lbs.
(2586 kg)



50%
13' (4.0 m) Spread



360°



Pounds

25 ft. Ext
& 78 ft.
Boom

Feet	30	40	50	60	70	78	103
10	38,800 (62)	39,300 (70)	39,150 (74.5)	*31,450 (78)			
12	33,750 (57.5)	34,200 (67)	34,500 (72)	31,450 (76)			
15	27,950 (50)	27,650 (62)	26,400 (68.5)	25,200 (73)	24,100 (76)	*16,200 (78)	
20	17,200 (34)	17,300 (53)	17,200 (62)	16,700 (67.5)	16,150 (71.5)	15,750 (74)	*12,500 (78)
25		11,450 (42.5)	11,600 (55)	11,800 (62)	11,750 (67)	11,500 (70)	11,350 (75.5)
30		8,130 (29)	8,280 (47)	8,460 (56.5)	8,660 (62.5)	8,780 (66)	8,800 (72.5)
35			6,100 (38)	6,270 (50)	6,450 (57.5)	6,610 (61.5)	6,990 (69.5)
40			4,550 (26)	4,730 (43)	4,900 (52)	5,060 (57.5)	5,610 (66.5)
45				3,590 (35)	3,760 (46.5)	3,910 (52.5)	4,430 (63.5)
50				2,690 (24)	2,880 (40)	3,020 (47.5)	3,520 (60)
55					2,180 (32.5)	2,320 (42)	2,800 (57)
60					1,590 (22.5)	1,750 (35.5)	2,210 (53)
65						1,260 (27.5)	1,720 (49.5)
70							1,310 (45.5)
0.1A (lbs.)	465	440	420	410	400	395	380
Minimum boom angle (deg.) for indicated length						21	43
Maximum boom length (ft.) at 0 deg. boom angle (no load)							70

NOTE: () Boom angles are in degrees.
* This capacity is based upon maximum boom angle.

Boom Angle	30	40	50	60	70
0°	10,950 (23.8)	6,370 (33.8)	3,640 (43.8)	2,140 (53.8)	1,210 (63.8)

NOTE: () Reference radii in feet.

A6-829-015873



30 - 78 ft.
(9.2 - 23.8 m)



5,700 lbs.
(2586 kg)



0%
7' 7" (2.3 m) Spread



360°



Pounds

Feet	30	40	50	60	70	78
10	24,650 (62)	23,350 (70)	22,050 (74.5)	*18,100 (78)		
12	18,850 (57.5)	18,250 (67)	17,450 (72)	16,650 (76)		
15	13,400 (50)	13,300 (62)	12,950 (68.5)	12,450 (73)	12,000 (76)	*11,450 (78)
20	8,320 (34)	8,390 (53)	8,500 (62)	8,340 (67.5)	8,120 (71.5)	7,940 (74)
25		5,410 (42.5)	5,550 (55)	5,730 (62)	5,740 (67)	5,640 (70)
30		3,560 (29)	3,700 (47)	3,860 (56.5)	4,040 (62.5)	4,090 (66)
35			2,440 (38)	2,600 (50)	2,770 (57.5)	2,910 (61.5)
40			1,520 (26)	1,680 (43)	1,850 (52)	1,990 (57.5)
45					1,150 (46.5)	1,280 (52.5)
0.1A (lbs.)	465	440	420	410	400	395
Minimum boom angle (deg.) for indicated length			13	38	44	48

Maximum boom length (ft.) at 0 deg. boom angle (no load)

40

NOTE: () Boom angles are in degrees.

* This capacity is based upon maximum boom angle.

Boom Angle	30	40
0°	5,850 (23.8)	2,540 (33.8)

NOTE: () Reference radii in feet.

A6-829-015874



30 - 78 ft.
(9.2 - 23.8 m)



5,700 lbs.
(2586 kg)



Stationary



360°

17.5 x 25 (20 Ply) Tires



Feet	30	40	50	60
10	18,150 (62)	18,150 (70)	18,150 (74.5)	
12	14,950 (57.5)	14,950 (67)	14,950 (72)	14,950 (76)
15	11,250 (50)	11,250 (62)	11,250 (68.5)	11,250 (73)
20	6,530 (34)	6,530 (53)	6,530 (62)	6,530 (67.5)
25		4,100 (42.5)	4,100 (55)	4,100 (62)
30		2,900 (29)	2,900 (47)	2,900 (56.5)
35			1,840 (38)	1,840 (50)
40			1,040 (26)	1,040 (43)
Minimum boom angle (deg.) for indicated length (no load)			5	29.5
Maximum boom length (ft.) at 0 deg. boom angle (no load)			40	
NOTE: () Boom angles are in degrees				

Boom Angle	30	40
0°	4,120 (23.8)	1,840 (33.8)

NOTE () Reference radii in feet.

A6-829-015875



30 - 78 ft.
(9.2 - 23.8 m)



5,700 lbs.
(2586 kg)



Stationary



Defined Arc
Over Front
±6°

17.5 x 25 (20 Ply) Tires



Pounds

Feet	30	40	50	60
10	21,650 (62)	21,650 (70)	21,650 (74.5)	
12	18,850 (57.5)	18,850 (67)	18,850 (72)	18,850 (76)
15	15,650 (50)	15,650 (62)	15,650 (68.5)	15,650 (73)
20	11,800 (34)	11,800 (53)	11,800 (62)	11,800 (67.5)
25		8,030 (42.5)	8,030 (55)	8,030 (62)
30		5,910 (29)	5,910 (47)	5,910 (56.5)
35			4,490 (38)	4,490 (50)
40			3,470 (26)	3,470 (43)
45				2,710 (35)
50				2,110 (24)
Minimum boom angle (deg.) for indicated length (no load)				0
Maximum boom length (ft.) at 0 deg. boom angle (no load)				60
NOTE: () Boom angles are in degrees				
Boom Angle	30	40	50	60
0°	8,720 (23.8)	4,790 (33.8)	2,880 (43.8)	1,750 (53.8)

NOTE () Reference radii in feet.

A6-829-015876



30 - 78 ft.
(9.2 - 23.8 m)



5,700 lbs.
(2586 kg)



Pick & Carry
Up to 2.5 MPH



Boom Centered
Over Front

17.5 x 25 (20 Ply) Tires



Pounds

Feet	30	40	50	60
10	21,000 (62)	21,000 (70)	21,000 (74.5)	
12	18,000 (57.5)	18,000 (67)	18,000 (72)	18,000 (76)
15	14,600 (50)	14,600 (62)	14,600 (68.5)	14,600 (73)
20	10,700 (34)	10,700 (53)	10,700 (62)	10,700 (67.5)
25		8,030 (42.5)	8,030 (55)	8,030 (62)
30		4,940 (29)	4,940 (47)	4,940 (56.5)
35			3,880 (38)	3,880 (50)
40			3,060 (26)	3,060 (43)
45				2,400 (35)
50				1,870 (24)
Minimum boom angle (deg.) for indicated length (no load)				0
Maximum boom length (ft.) at 0 deg. boom angle (no load)				60
NOTE: () Boom angles are in degrees				
Boom Angle	30	40	50	60
0°	8,700 (23.8)	4,120 (33.8)	2,560 (43.8)	1,520 (53.8)

NOTE: () Reference radii in feet.

A6-829-015877





































Rated Lifting Capacities

IMPORTANT NOTES:

WARNING: THIS CHART IS ONLY A GUIDE.
The notes below are for illustration only and should not be relied upon to operate the crane.
The individual crane's load chart, operating instructions and other instruction plates must be read and understood prior to operating the crane.

1. All rated loads meet ANSI/ASME B30.5, Mobile and Locomotive Cranes. Testing and development were performed to SAEJ1063, Cantilevered Boom Crane Structures - Method of Test and SAEJ765 Crane Stability Test Code.
2. Rated loads include the weight of hookblock, slings and auxiliary lifting devices and their weights shall be subtracted from the listed rating to obtain the net load to be lifted. When more than the minimum required hoist reeving is used, the additional rope weight shall be considered part of the load to be handled.
3. Defined Arc $\pm 6^\circ$ on either side of longitudinal centerline of machine.
4. Capacities appearing above the bold line are based on structural strength. Tipping should not be relied upon as a capacity indication.
5. The machine shall be leveled on a firm supporting surface. Depending on the nature of the supporting surface, it may be necessary to have structural supports under the outrigger floats or tires to spread the load to a larger bearing surface.
6. When either boom length or radius or both are between values listed, the smallest load shown at either the next larger radius or next longer or shorter boom length shall be used.
7. Tires shall be inflated to the recommended pressure before lifting on rubber.
8. For outrigger operation, outriggers shall be properly extended with tires raised free of crane weight before operating the boom or lifting loads.

Symbols Glossary

	Frame		Steering
	Outriggers		Transmission
	Outrigger Controls		Axles
	Engine		Brakes
	Fuel Tank Capacity		Tires
	Electrical System		Suspension
	Drive		Rotation
	Lights		Boom Elevation
	Cab		Swing
	Boom		Counterweight
	Fixed Swingaway		Oil
	Tele-Swingaway		Hydraulic System
	Jib		Hoist
	Boom Nose		Radius
	Boom Extension		Boom Length
	Speed		Hookblock
	Grade		Gear
	Lattice Extension		Luffing Jib

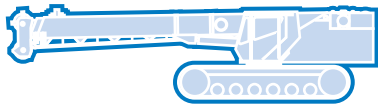
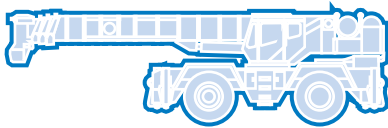
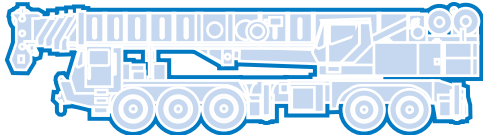
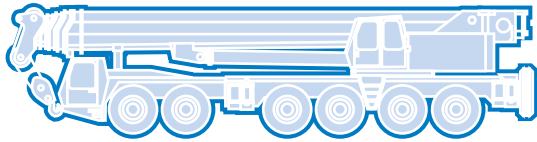
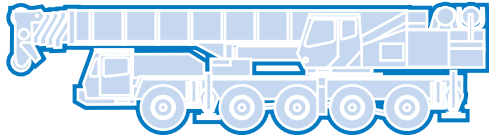

Grove Worldwide – World Headquarters

Grove North America

1565 Buchanan Trail East
P.O. Box 21
Shady Grove, Pennsylvania 17256, U.S.A.
Tel: [Int + 1] (717) 597-8121
Fax: [Int + 1] (717) 597-4062
Western Hemisphere, Asia/Pacific

Grove Europe Limited*

Sunderland SR4 6TT, England
Tel: [Int + 44] 191 565-6281
Fax: [Int + 44] 191 564-0442
Europe, Africa, Middle East

Grove Europe Limited*

P.O. Box No. 268
4A Kimber Road
Abingdon, Oxfordshire, OX141SG
Tel: [Int + 44] 1235 55-3184
Fax: [Int + 44] 1235 55-3218

*Grove Europe Limited, Registered in England,
Number 1845128, Registered office, Crown Works,
Pallion, Sunderland, Tyne & Wear, England SR4 6TT

Deutsche Grove GmbH

Sales and Service
Helmholtzstrasse 12, Postfach 5026
D-40750 Langenfeld, Germany
Tel: [Int + 49] (2173) 8909-0
Fax: [Int + 49] (2173) 8909-30

Wilhelmshaven Works

Industriegelände West, Postfach 1853
D-26358 Wilhelmshaven, Germany
Tel: [Int + 49] (4421) 294-0
Fax: [Int + 49] (4421) 294-301

Grove France S.A.

16, chaussée Jules-César, 95520 OSNY
B.P. 203, 95523 CERGY PONTOISE CEDEX
France
Tel: [Int + 33] (1) 30313150
Int: [Int + 33] (1) 30386085

Grove Asia/Pacific - Regional Office

171 Chin Swee Road
#06-01 San Centre
Singapore 0316
Tel: [Int + 65] 536-6112
Fax: [Int + 65] 536-6119
Asia/Pacific, Near East

Grove China - Representative Office

Beijing Suite 6074
No. 33 East Chang An Avenue
Beijing, 100004, China
Tel: [Int + 86] (10) 513-7766
Fax: [Int + 86] (10) 513-7307

Grove Product Support

Western Hemisphere, Asia/Pacific
1086 Wayne Avenue
Chambersburg, Pennsylvania USA
Tel: [Int + 1] (717) 263-5100
Fax: [Int + 1] (717) 267-0404

Europe, Africa, Middle East
Sunderland SR4 6TT, England
Tel: [Int + 44] 191 565-6281
Parts Fax: [Int + 44] 191 510-9242
Service Fax: [Int + 44] 191 510-9560

<http://www.groveworldwide.com>

Constant improvement and engineering progress make it necessary that we reserve the right to make specification, equipment, and price changes without notice. Illustrations shown may include optional equipment and accessories and may not include all standard equipment.

Distributed By: