

The National Pedestal-Mounted Marine Lifting Systems



NATIONAL CRANE

Your National Dealer:

General Offices: 11200 North 148th Street / Waverly, NE 68462
Phone: (402) 786-2240 / Telex: 438061

National reserves the right to change designs, prices, and specifications at any time without notice.

Printed in USA

Form No. PM/M4889M

© 1988 National Crane



National Crane Corporation manufactures pedestal-mounted cranes for docks, factories, towers, yards and other sites where the need for fixed, stationary lifting, loading and unloading exists. Pedestal-mounted telescoping cranes with marine conditioning are ideal for shipboard, dockside, offshore and other marine-related workites.

Full marine conditioning is standard on all National marine cranes. All external surfaces are sand-blasted, coated with inorganic zinc primer, painted, and coated with a durable chlorinated rubber topcoat. All interior surfaces and cylinders are carefully primed and painted to help prevent corrosion.

On cranes manufactured for marine working environments, lift cylinder shafts, and boom pivot pins are stainless steel to withstand the rigors of corrosive salt water and chemical environments. Continuous welds are made wherever possible to prevent the formation of corrosion in crevices. National marine conditioning extends the crane life while reducing maintenance requirements.

Strong Four-Plate Booms

Whether your pedestal-mounted lifting requirements are at land-based or harsh marine workites, you will benefit from National's four-plate boom construction. National fabricates all telescoping boom sections from high-strength steel members welded with perpendicular corners. This box-section (four-plate) construction utilizes thicker top and bottom

plates to achieve extra strength. And it utilizes thinner side plates to increase the lifting capacity through lower boom weight.

Only strong, low-alloy steel is used in National booms. It is welded with automatic, low-hydrogen techniques for extra-strong seams. Corner seams are ultrasonically tested for proper weld penetration.

Fast, Smooth Slewing

National turret drives are engineered for fast, smooth, controlled slewing. They require minimal maintenance, even under harsh marine conditions. Routine service is easy.

The Series 400, Series 600B, and Series 800B utilize a planetary rotation gearbox with a hydraulic release brake that allows the gearbox to backdrive whenever excessive side load is applied to the boom, reducing shock loads on the upper and lower crane structure and gearbox

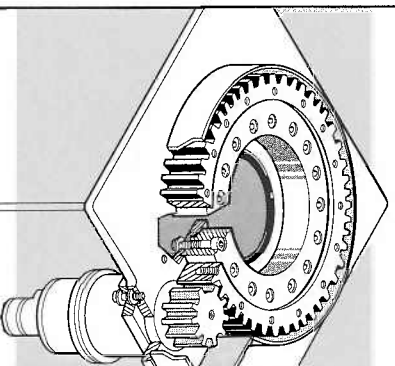

The turret drive is designed with extra-heavy bearings below the drive pinion. The gearbox and rotation bearing mounting surfaces are precision machined after welding. This ensures consistent tooth alignment for smooth rotation and even wear, even under maximum loads. The entire turret glides smoothly on a low inertia ball bearing race. Rotation is 375° non-continuous (continuous rotation is optional on the 400, 600B, and 800B).

The Series 200 utilizes the precision of rack-and-pinion rotation. The system is simple, reliable and, because it has fewer parts, easy to maintain. Rotation is 390° non-continuous.

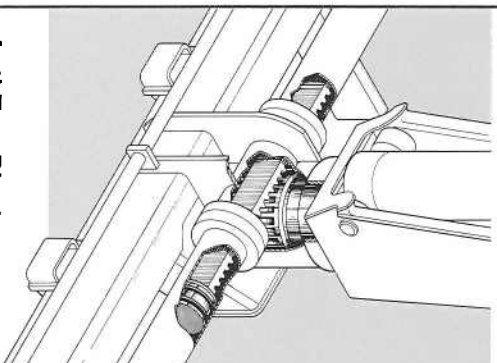

Anti-Two-Block Protection

All National pedestal-mounted hydraulic telescoping cranes are equipped with a standard anti-two-block system. Two-blocking occurs when the winch cable and attachments contact the underside of the boom sheave case, whether by winching up or extending the boom without paying out the winch cable. When this happens, the cable can be damaged by crimping or over-tensioning. The anti-two-block system helps prevent cable damage by sensing the position of the winch cable and attachments with respect to the sheave case and shutting down the functions that cause two-blocking.

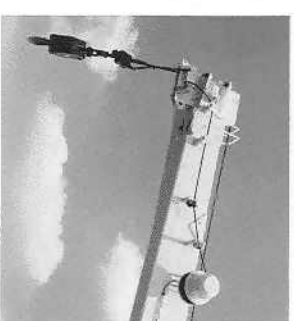

High Performance Winch Systems

The National Series 400, Series 600B, and Series 800B cranes are equipped with high-performance planetary winch systems with rotation resistant cable. The Series 400's high-efficiency winch coupled with a hydraulic motor and counterbalance valve for "power down" load lowering provides smooth loadline control and quiet operation. All Series 600B and 800B cranes come equipped with a high-performance Braden PD-12C winch. Anti-friction

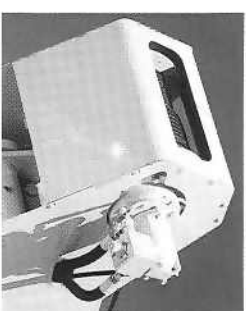

bearings are used throughout to maximize efficiency and seal life. A "Burst-of-Speed" feature — standard on the 800B with dual side pedestal controls* and optional on the 600B with dual side pedestal controls* — permits an extra fast and efficient pay-out and pick-up of unloaded cable ("Burst-of-Speed" circuitry increases line speed up to 60% over normal). The Series 200 is equipped with a durable Tulsa 9 worm-gear winch with an automatic friction brake and a hydraulic motor control valve brake. *

Explosion-Proof Systems

National provides an optional complete crane power pack and anti-two-block system in an explosion-proof class-one, group D version. This option is designed specifically for pedestal-mounted cranes that operate in hazardous gaseous or explosion-prone environments.

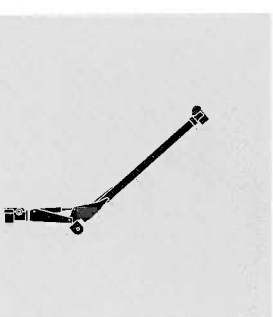

- Series 200
- 6,000-pound capacity at 10 feet
- 10,700-pound maximum capacity

The 200 provides the quality and performance of larger Nationals in a compact, cost-efficient package. It is ideal for use on smaller boats and barges, dockside and terminal work, offshore platforms, or wherever light-duty lifting is required.

Boom Lengths Available

- Model 228: 16' to 28'
- Model 216: 16' to 1-section

Rotation

- Non-continuous, 390°

Winch

- Standard Model Tulsa 9
- Line Pull Bare 6,100 lbs.*
- Line Pull Full 5,100 lbs.*
- Line Speed Full 42 fpm
- *Because of the 5 to 1 ANSI safety factor, maximum rated pull cannot exceed 4,100 lbs. on a single line.

Accessories

- Two-and-three part line block
- Capacity alert systems
- Dual side stand up controls
- Remote valve control station group
- Electric motor (explosion proof motor available)
- Lister diesel engine power pack
- Reservoir
- Control console
- Total power package

Note: All booms are available with or without marine conditioning.

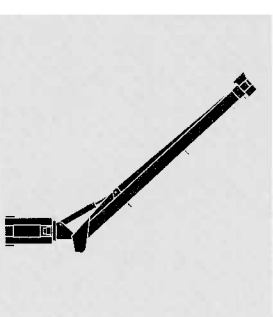

- Series 400
- 8,000-pound capacity at 10 feet
- 16,000-pound maximum capacity

The 400 is designed for high-performance, medium-duty lifting. Its mid-range capacity and reliability have made it the workhorse of fishing fleets.

Boom Lengths Available

- Model 455: 22' to 55'
- Model 446: 19' to 46'
- Model 437: 16' to 37'

Rotation

- Non-continuous, 375°
- Continuous (optional)

Winch

- Standard Model 6,450 lbs.*
- Line Pull Bare 5,500 lbs.
- Line Speed Full 92 fpm
- Optional Model (High Pull)
- Line Pull Bare 10,200 lbs.*
- Line Pull Full 8,400 lbs.**
- Line Speed Full 55 fpm
- *Because of the 5 to 1 ANSI safety factor, maximum rated pull on a single line cannot exceed 5,500 lbs. on Standard Model or 7,000 lbs. on Optional Model.

Accessories

- Two-and-three part line block
- Capacity alert systems
- Dual stand up controls
- Remote valve control station group
- Electric motor (explosion proof motor available)
- Lister diesel engine power pack
- Reservoir
- Control Console
- Total power package

Note: All booms are available with or without marine conditioning.



- Series 600B
- 17,000-pound capacity at 10 feet
- 28,000-pound maximum capacity

The 600B, with proportional boom design, provides higher capacities in normal lifting areas. It features a high-performance planetary winch and heavy-duty capabilities.

Boom Lengths Available

- Model 666B: 26' to 66'
- Model 656B: 22' to 56'
- Model 647B: 19' to 47'
- Model 638B: 16' to 38'
- Model 622B: 22' to 1-section

Rotation

- Non-continuous, 375°
- Continuous (optional)

Winch

- Standard Model Braden PD-12C
- Line Pull Bare 10,200 lbs.*
- Line Pull Full 8,400 lbs.**
- Line Speed Full 93 fpm
- *Because of the 5 to 1 ANSI safety factor, maximum rated pull on a single line cannot exceed 7,000 lbs.

Accessories

- Two-and-three part line block
- Capacity alert systems
- Dual stand up controls
- Remote valve control station group
- Electric motor (explosion proof motor available)
- Lister diesel engine power pack
- Reservoir
- Control console
- Total power package

Note: All booms are available with or without marine conditioning.

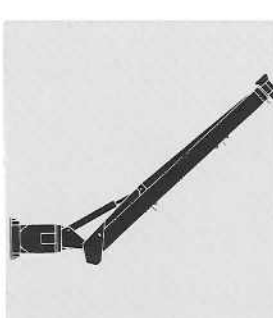

- Series 800B
- 20,000-pound capacity at 10 feet
- 35,000-pound maximum capacity

The 800B is National's maximum-capacity marine crane. Its industry-acclaimed four-section hydraulic boom provides extra long reach. National's Burst-of-Speed winch feature for fast payout and pick-up of cable is standard on crane with dual side pedestal controls.

Boom Lengths Available

- Model 875B: 22' to 75'
- Model 856B: 22' to 56'
- Model 839B: 22' to 39'

Rotation

- Non-continuous, 375°
- Continuous (optional)

Winch

- Standard Model Braden PD-12C
- Line Pull Bare 10,200 lbs.*
- Line Pull Full 8,400 lbs.**
- Line Speed Full 93 fpm**
- *Because of the 5 to 1 ANSI safety factor, maximum rated pull on a single line cannot exceed 7,000 lbs.
- **Optional wire rope pull is 8,400 lbs. and the line speed full is 93 fpm.

Accessories

- Two-part line block
- Two-and-three-part line block
- Two, three, four, and five-part line block
- Capacity alert systems
- Dual stand up controls
- Remote valve control station group
- Electric motor (explosion proof motor available)
- Lister diesel engine power pack
- Reservoir
- Control console
- Total power package

Note: All booms are available with or without marine conditioning.

National Marine Cranes Accessory Equipment

National provides several control options for its pedestal-mounted marine cranes.

Dual Side Pedestal Control

Dual controls with extra-fine metering and low pool force give you smooth, precise control and excellent load visibility. Controls on National's marine pedestal cranes are identical on each side, so you consistently work the same control with the same hand. Dual side controls are not recommended for extreme marine environments.

Remote Valve Control (RVC)

This stationary hydraulic control unit may be mounted remotely from the crane. The hydraulic control valves provide operation of the tilt, slewing, telescoping function, and winch. They are fine-metering spool-type units identical to those used on the dual side pedestal control. The RVC includes filter, flow divider, and control valves on an angle base ready for mounting and connection to the hydraulic supply. This model is not weather protected.

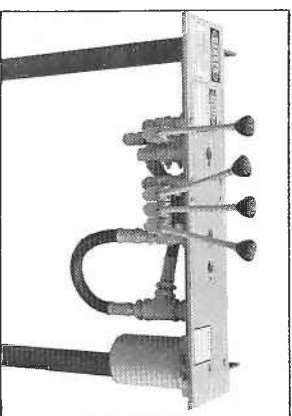

Control Console (6000-C)

This weather-protected Console can be located where the operator can best observe loads for maximum safety and efficiency. It includes extra strong steel cabinet weldment with a built-in spill container and a protective hinged cover. It has turn, boom, telescope, and winch valve subassemblies; a push button start/stop station for the electrical power pack; system pressure gauge; with necessary internal wiring terminating in an accessible junction box. All internal plumbing is included. Letter-designated work ports are provided on the bottom of the Console cabinet; these match letter-designated work ports on the base of the crane to facilitate ease of hook up. All external and internal surfaces are sandblasted and coated with an inorganic zinc paint system. The 6000-C can be connected to either the existing vessel hydraulic system or to the separate power package available from National.

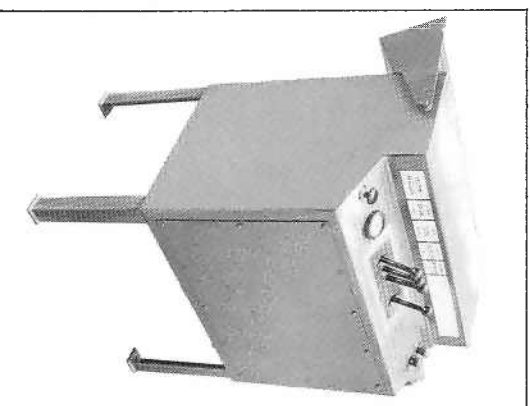

Control Console (6000-C)

Power Pack and Pump with Reservoir

For independent operation of your National marine crane, motors are available in TEFC (Totally-Enclosed, Fan Cooled), or XP (Explosion Proof) Class I Group D models. Both are available in 25 and 50 horsepower driving a balanced vane pump at 1,800 rpm. The reservoir is a 60-gallon hydraulic unit complete with removable access panel with heavy-duty gasket, internal diffuser, convoluted pump strainer (60 mesh), filter, breather, sight level gauge, tank baffle, return line filter — 10 micron with 25 psi bypass (element replaceable), condensation drain-off valve, pump isolation (shut-off) valve, and four mounting legs with one mounting hole in the base of each leg. Mounting the reservoir directly above the power supply provides forced suction of hydraulic fluid which extends the life of the hydraulic pump. Due to potential wiring variances, starter motor is not included. The reservoir can be purchased with the pump as shown at the left or the reservoir and pump can be purchased as separate units.

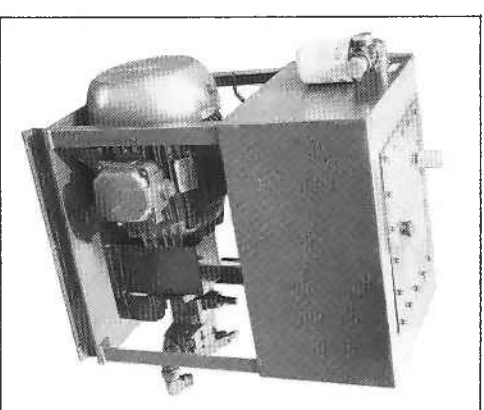

The total power package shown above includes pump, tank, control and motor assembly plumbed together in a free standing unit. The unit has been tested and is ready for electrical hook-up to your starter and plumbing hook-up to your crane.

NOTE: Diesel power packages are also available. Contact the factory for details.

Do not operate cranes or accessories within 10 feet of live power lines.

National Marine Cranes Technical Data

	Marine 200	Marine 400	Marine 600B	Marine 800B
Capacity at 10 ft.*	6,000 lbs.	8,000 lbs.	17,000 lbs.	20,000 lbs.
Max. Capacity*	10,700 lbs.	16,000 lbs.	28,000 lbs.	35,000 lbs.
Rotation				
Non-Continuous	390°	375°	375°	375°
Continuous	N/A	N/A	Optional	Optional
Speed	56 sec.	89 sec.	86 sec.	81 sec.
Controls				
Dual Side**	Optional	Optional	Optional	Optional
RVC**	Optional	Optional	Optional	Optional
Console	Optional	Optional	Optional	Optional
Hydraulic Requirements				
Boom	5.5 gpm/2,500 psi	5.5 gpm/2,625 psi	12 gpm/2,825 psi	12 gpm/2,950 psi
Winch	12.5 gpm/2,500 psi	12.5 gpm/3,050 psi	21 gpm/3,050 psi	21 gpm/3,050 psi
Winch				
Standard Model	Tulsa 9	GP5500	Braden PD-12	Braden PD-12
Line Pull Bare	6,100 lbs.	6,450 lbs.	10,200 lbs.	10,200 lbs.
Line Speed Full	42 fpm	92 fpm	93 fpm	93 fpm
Optional Model	N/A	Braden PD-12		
Line Pull Bare		10,200 lbs.		
Line Speed Full		55 fpm		

*All boom capacities are based on the following system operating pressures. For systems with other pressures, contact factory for information.

Marine 200 2,500 psi
Marine 400 2,625 psi
Marine 600B 2,825 psi
Marine 800B 2,950 psi

**Not marine conditioned

Power Pack Specifications

Components: Electric Motor, Hydraulic Pump, Mounting Bracket

Electric Motor:

Types: A. Totally Enclosed Fan-Cooled (TEFC)
B. Explosion Proof, Class I, Group D (XP)

Speed: 1,800 rpm

Voltage: 230/460 AC

Hertz: 60 Hz

Phase: 3

(Due to potential wiring variances, motor starter is not included.)

Mounting Bracket: Heavy duty, steel base weldment with six mounting holes.

Balance Vane Hydraulic Pump

	Marine 200	Marine 400	Marine 600B	Marine 800B
Pump:	Single pump* 25 hp	Single pump* 25 hp	Tandem pump 50 hp	Tandem pump 50 hp
Flow rate:				
Boom:	5.5 gpm*	5.5 gpm*	12 gpm	12 gpm
Winch	12.5 gpm	12.5 gpm	21 gpm	21 gpm
Pressure:				
Boom:	2,500 psi	2,650 psi	2,825 psi	2,950 psi
Winch	2,500 psi	3,050 psi	3,050 psi	3,050 psi

*Hydraulic control system must be equipped with 70:30 flow divider (70% flow to winch circuit; 30% flow to boom circuit.)

Warranty and Parts

National Marine 200 Load Rating Data

The National Parts System

Authorized National crane dealers maintain a parts supply to support National cranes in each dealer's area. If your dealer cannot immediately supply a needed part, the factory maintains a back-up parts supply that provides 24-hour parts shipping in 85% of all breakdown rush orders. National responsiveness means that your crane will be back in service fast. National maintains a Service and Parts staff to answer dealer service questions and expedite parts shipping.

The National Warranty

National's warranty covers your crane against defects in materials or workmanship for **six full months** from the date of shipment, subject to the conditions of the warranty. When you select a National crane, you get strong warranty protection and National's concern for every product we manufacture.

For complete information, write National Warranty Service, Waverly, NE 68462.

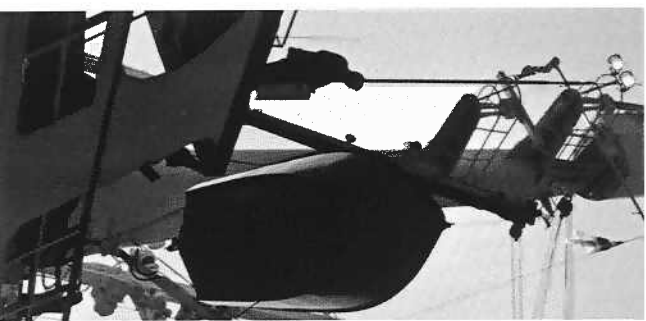

NATIONAL SERIES 200 WINCH DATA	1-Part Line	2-Part Line	3-Part Line

Caution: Do not deadhead lineblock against boom tip when extending boom. Keep at least three wraps of load line on drum at all times. Use only the specified cable on this machine.

These are the ratings of the winch system when reeved accordingly.

Winch	Cable Supplied	Average Breaking Strength	Lift and Speed	Lift and Speed	Lift and Speed
Tulsa Model 9	Standard 7/16" diam. rotation resistant	20,500 lbs.	4,100 lbs. 42 fpm	8,200 lbs. 21 fpm	10,700 lbs. 19 fpm
	Optional 7/16" diam. 6 x 25 IWRC	17,940 lbs.	5,100 lbs. 42 fpm	10,200 lbs. 21 fpm	10,700 lbs. 19 fpm

All winch pulls and speeds are shown on the third layer. Winch pulls would increase on the first and second layers. Winch line speeds would decrease on the first and second layers. Winch pulls may be limited by the winch capacity or the cable safety factor. These are shown below.

Winch

With standard rotation resistant rope 6,100 pounds
With optional 6 x 25 IWRC rope 6,100 pounds

Bare Drum Pull 4,100 pounds
*Maximum bare drum pull is 6,100 pounds with Tulsa Model 9 winch, however, because of the 5 to 1 safety factor, maximum rated pull on a single line cannot exceed 4,100 pounds on rotation resistant cable.

Winch

With standard rotation resistant rope 6,100 pounds
With optional 6 x 25 IWRC rope 6,100 pounds

Bare Drum Pull 4,100 pounds
*Maximum bare drum pull is 6,100 pounds with Tulsa Model 9 winch, however, because of the 5 to 1 safety factor, maximum rated pull on a single line cannot exceed 4,100 pounds on rotation resistant cable.

Allowable Cable Pull

With standard rotation resistant rope 6,100 pounds
With optional 6 x 25 IWRC rope 6,100 pounds

Allowable Cable Pull 4,100 pounds
*Maximum bare drum pull is 6,100 pounds with Tulsa Model 9 winch, however, because of the 5 to 1 safety factor, maximum rated pull on a single line cannot exceed 4,100 pounds on rotation resistant cable.



Load ratings are shown in pounds on the charts below and on the following three pages. These charts make no allowance for such factors as the effect of freely suspended loads, wind, or operating speeds. The operator, therefore, must reduce the load rating to take these conditions into account. Weights of accessories must be deducted from the chart capacities. Do not exceed capacities at any reduced boom lengths. **Overloading may cause structural collapse.**

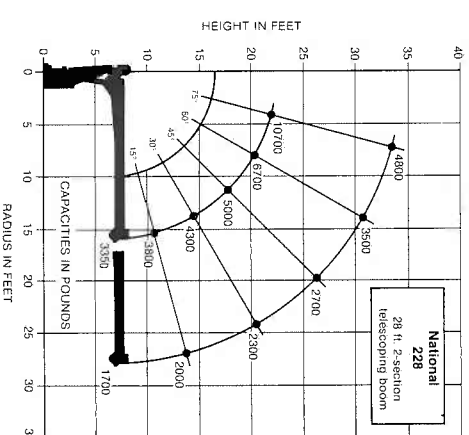
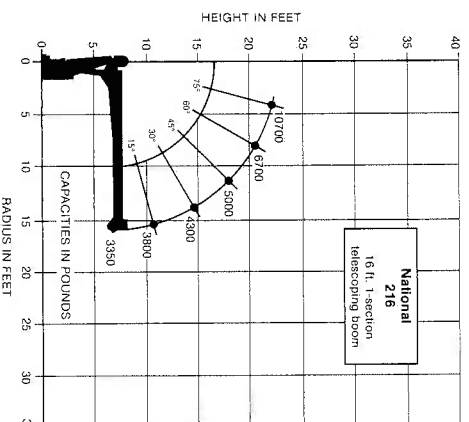

Do not operate National cranes or accessories within 10 feet of live power lines.

National Marine 400 Load Rating Data

NATIONAL SERIES 400 WINCH DATA	1-Part Line	2-Part Line	3-Part Line

Caution: Do not deadhead lineblock against boom tip when extending boom. Keep at least three wraps of load line on drum at all times. Use only the specified cable on this machine.

Winch	Cable Supplied	Average Breaking Strength	Lift and Speed	Lift and Speed	Lift and Speed
Standard Planetary Winch	1/2" diam. rotation resistant	27,500 lbs.	5,500 lbs. 92 fpm	11,000 lbs. 46 fpm	16,000 lbs. 30 fpm
Optional High-pull Planetary Winch	Standard 9/16" diam. rotation resistant	35,000 lbs.	7,000 lbs. 92 fpm	14,000 lbs. 46 fpm	16,000 lbs. 30 fpm
	Optional 9/16" diam. 6 x 19 or 6 x 25 IWRC	29,750 lbs.	8,400 lbs. 55 fpm	16,000 lbs. 27 fpm	—

All winch pulls and speeds are shown on the third layer. Winch pulls would increase on the first and second layers. Winch line speeds would decrease on the first and second layers. Winch pulls may be limited by the winch capacity or the cable safety factor. These are shown below:

Winch
Standard Planetary 6,450 lbs.
(With Optional Cable) 6,450 lbs.
Standard Planetary 10,200 lbs.
(With Optional Cable) 10,200 lbs.

Bare Drum Pull 5,500 lbs.
Full Drum 5,500 lbs.
Allowable Cable Pull 5,500 lbs.

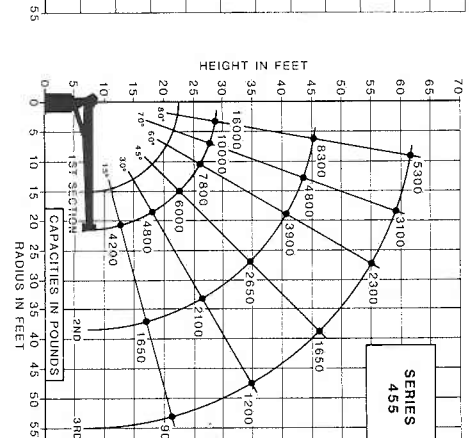
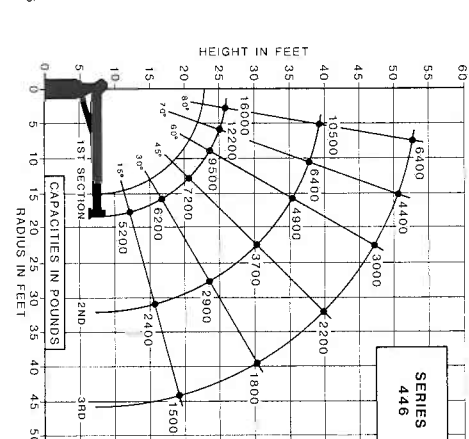
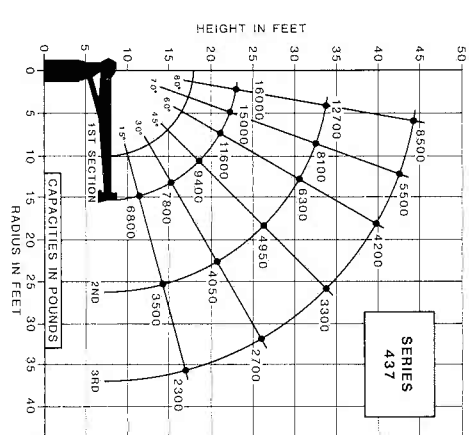

National Marine 600B Load Rating Data

NATIONAL SERIES 600B WINCH DATA		Caution:				
Do not deadhead lineblock against boom tip when extending boom. Keep at least three wraps of load-line on drum at all times. Use only the specified cable on this machine.						
Winch	Cable Supplied	Average Breaking Strength	Lift and Speed	Lift and Speed	Lift and Speed	Lift and Speed
Standard Planetary Winch	Standard 3/16" diameter rotation resistant	35,000 lbs.	7,000 lbs. 93 fpm	14,000 lbs. 47 fpm	21,000 lbs. 31 fpm	28,000 lbs. 23 fpm
	Optional 3/16" diameter 6 x 25 IWRC	29,750 lbs.	7,500 lbs.* 8,400 lbs.† 93 fpm	15,000 lbs.* 16,800 lbs.† 47 fpm	22,500 lbs.* 25,200 lbs.† 31 fpm	28,000 lbs.* 28,000 lbs.† 23 fpm
With Optional Burst-of-Speed Feature**	Same as corresponding cable data shown above		3,000 lbs. 150 fpm	6,000 lbs. 75 fpm	9,000 lbs. 50 fpm	12,000 lbs. 37 fpm

Data applies to all 600B booms.

*Applicable to the 666B boom.
†Applicable to all other Series 600B booms.
Speeds shown are the same for all Series 600B booms.

All winch pulls and speeds are shown on the third layer (the fourth layer on 666B). Winch pulls would increase on the first and second layers. Winch line speeds would decrease on the first and second layers. Winch line pulls may be limited by the winch capacity or the cable safety factor. These are shown below:

Winch
With standard rotation resistant rope 10,200 pounds
With optional 6 x 25 IWRC rope 7,000 pounds
*This feature is available with either the standard or optional cable. Ratings are based on intermittent use. High cycle applications may require optional oil cooler. Available only with dual side pedestal controls.

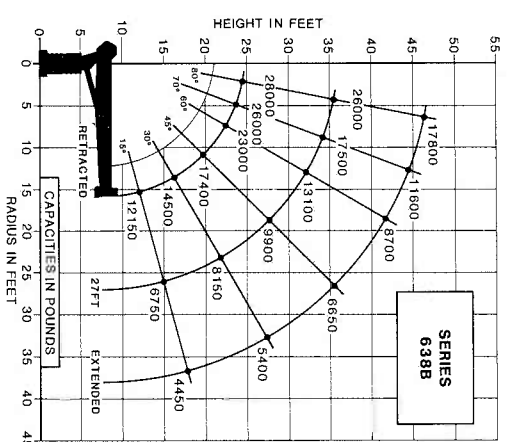
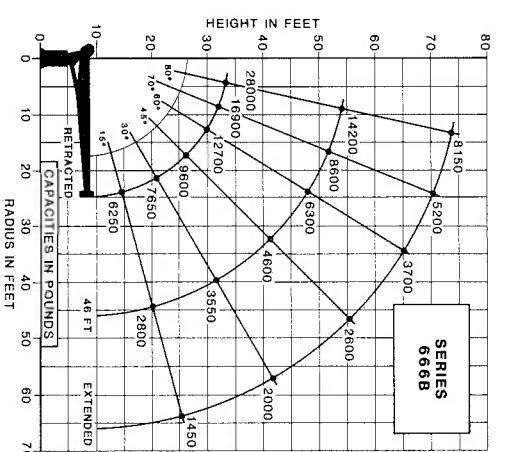
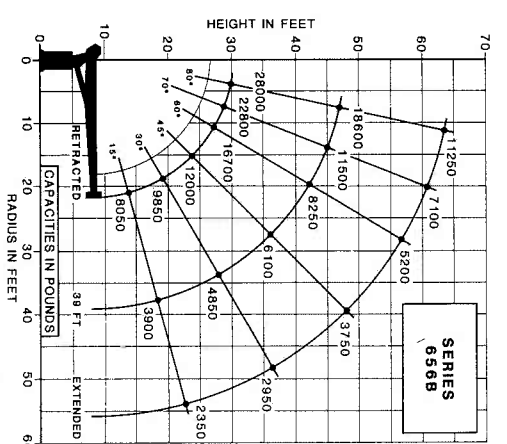
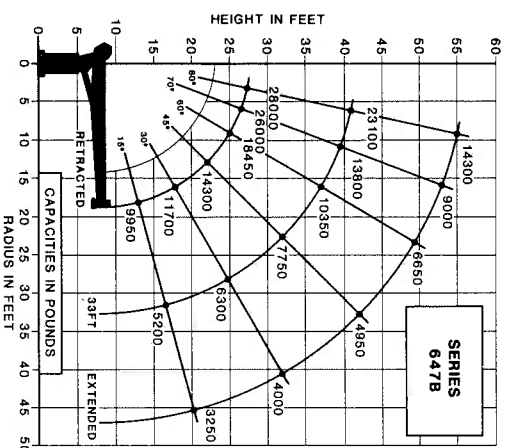

National Marine 800B Load Rating Data

NATIONAL SERIES 800B WINCH DATA		Caution:					
Do not deadhead lineblock against boom tip when extending boom. Keep at least three wraps of load line on drum at all times. Use only the specified cable on this machine.							
Winch	Cable Supplied	Average Breaking Strength	Lift and Speed	Lift and Speed	Lift and Speed	Lift and Speed	
Standard Planetary Winch	Standard 3/16" diameter rotation resistant	35,000 lbs.	7,000 lbs. 93 fpm	14,000 lbs. 47 fpm	21,000 lbs. 31 fpm	28,000 lbs. 23 fpm	35,000 lbs. 19 fpm
	Optional 3/16" diameter 6 x 25 IWRC	29,750 lbs.	7,500 lbs.* 8,400 lbs.† 93 fpm	15,000 lbs.* 16,800 lbs.† 47 fpm	22,500 lbs.* 25,000 lbs.† 31 fpm	30,000 lbs.* 34,000 lbs.† 23 fpm	35,000 lbs.* 35,000 lbs.† 19 fpm
With Optional Burst-of-Speed Feature**	Same as corresponding cable data shown above.		3,000 lbs. 150 fpm	6,000 lbs. 75 fpm	9,000 lbs. 50 fpm	12,000 lbs. 37 fpm	15,000 lbs. 30 fpm

Data applies to all 800B booms.

*Applicable to the 875B boom.
†Applicable to all other Series 800B booms.
Speeds shown are the same for all Series 800B booms.

All winch pulls and speeds are shown on the third layer (the fourth layer on 875B). Winch pulls would increase on the first and second layers. Winch line speeds would decrease on the first and second layers. Winch line pulls may be limited by the winch capacity or the cable safety factor. These are shown below:

Winch
With standard rotation resistant rope 10,200 pounds
With optional 6 x 25 IWRC rope 7,000 pounds
*This feature is available with either the standard or optional cable. Ratings are based on intermittent use. High cycle applications may require optional oil cooler. Available only with dual side pedestal controls.

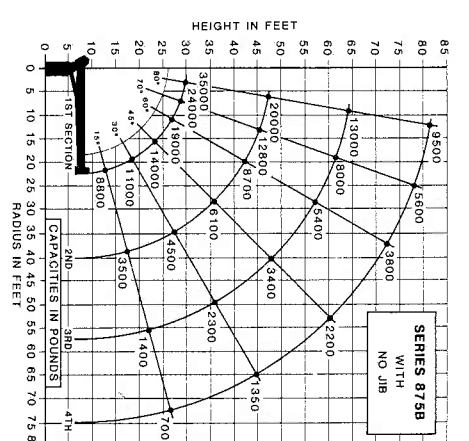
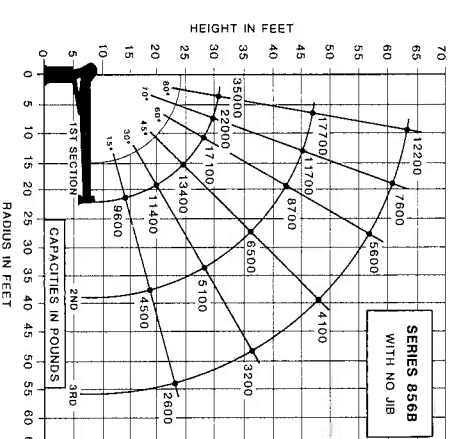
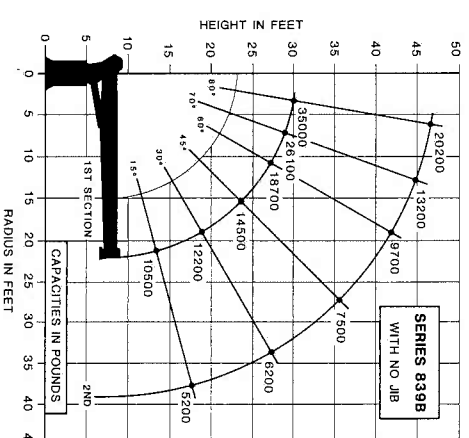

Do not operate National cranes or accessories within 10 feet of live power lines.

SERIES 200

Load Moment at Mounting Surface

840,000 in-lb

Rotational Force

130,000 in-lb

Thrust Load at Mounting Surface

14,200 lbs.

Mounting Bolts and Nuts

1½-7 UNC GR 8 Bolts, extending 5" above the mounting surface. Torqued to 960 ft/lbs. Nuts 1½-7 GR 8.

Rotation

390° non-continuous. Stop centered over rear of crane.

Weight

Model 216: 2,440 lbs.
Model 228: 2,800 lbs.

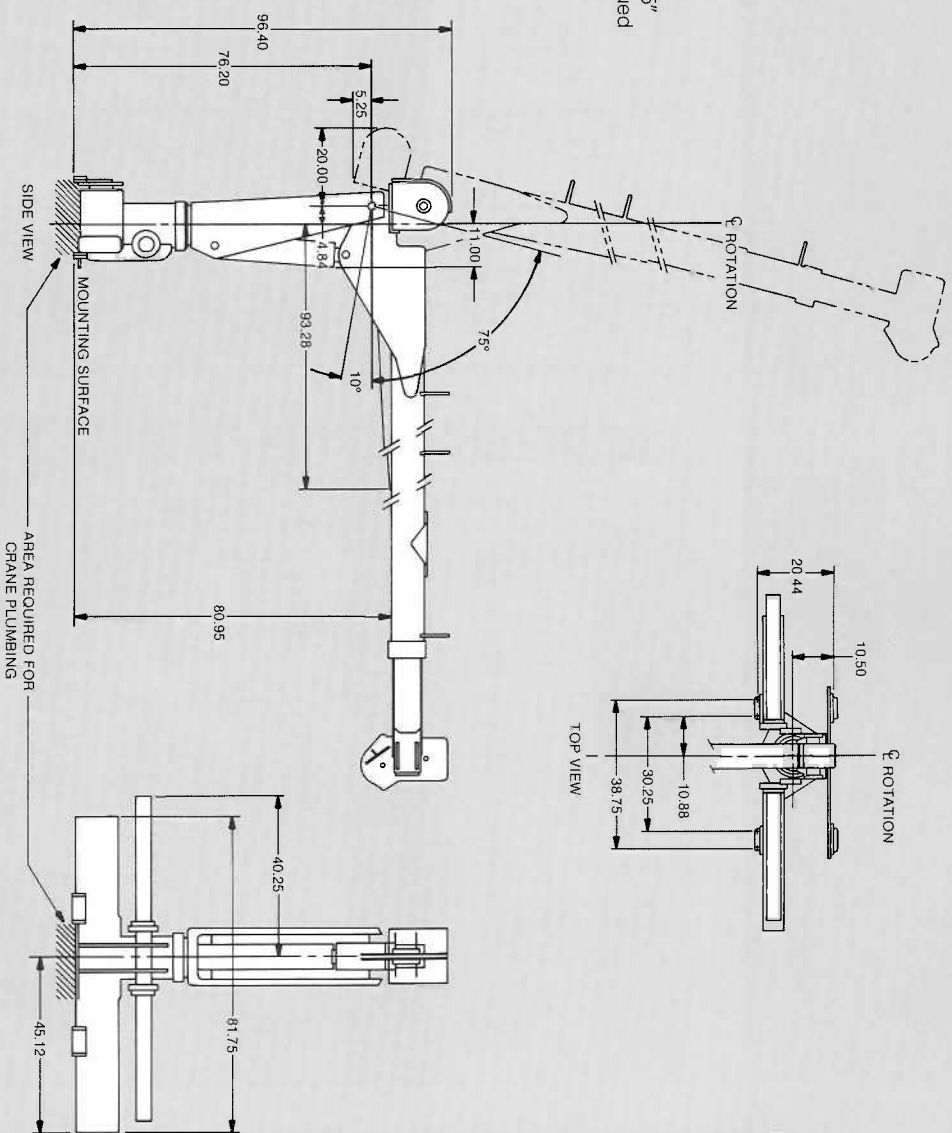

SERIES 600B

Load Moment at Mounting Surface

2,750,000 in-lb

Rotational Force

237,000 in-lb

Thrust Load at Mounting Surface

28,000 lbs.

Mounting Bolts and Nuts

1-8 UNC Grade 8, extending 2½" above the mounting surface. Torqued to 800 ft/lbs.

Rotational Stop Locations

Rotational stops which allow minimum of 60° rotation up to 375° rotation in any desired quadrant. Contact factory for details.

Weight

Model 638B: 8,100 lbs.
Model 647B: 8,500 lbs.
Model 656B: 9,000 lbs.
Model 666B: 9,600 lbs.

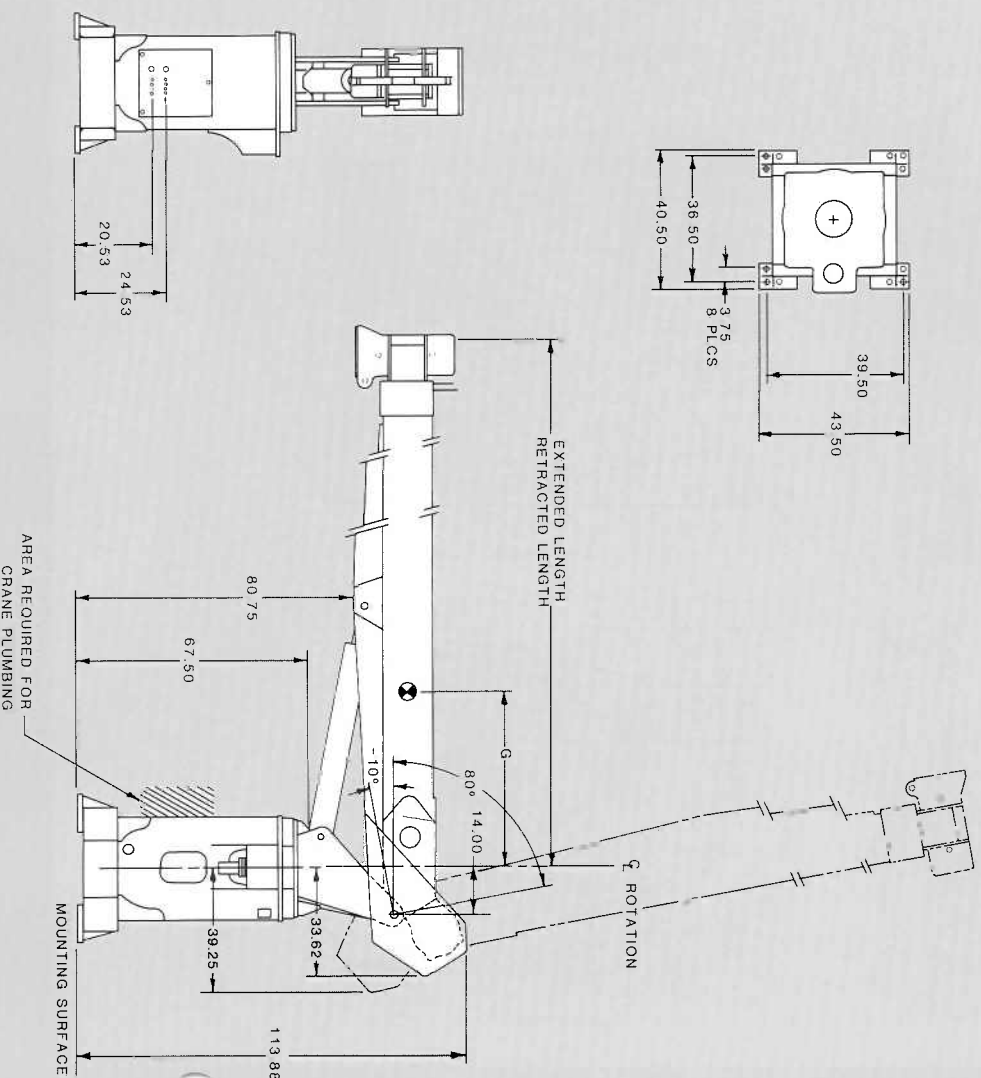

SERIES 400

Load Moment at Mounting Surface

1,404,000 in-lb

Rotational Force

120,000 in-lb

Thrust Load at Mounting Surface

24,000 lbs.

Mounting Bolts and Nuts

1-8 UNC Grade 8, extending 2½" above the mounting surface. Torqued to 900 ft/lbs.

Rotational Stop Locations

Rotational stops which allow minimum of 60° rotation up to 375° rotation in any desired quadrant. Contact factory for details.

Weight

Model 437: 5,120 lbs.
Model 446: 5,520 lbs.
Model 455: 5,870 lbs.

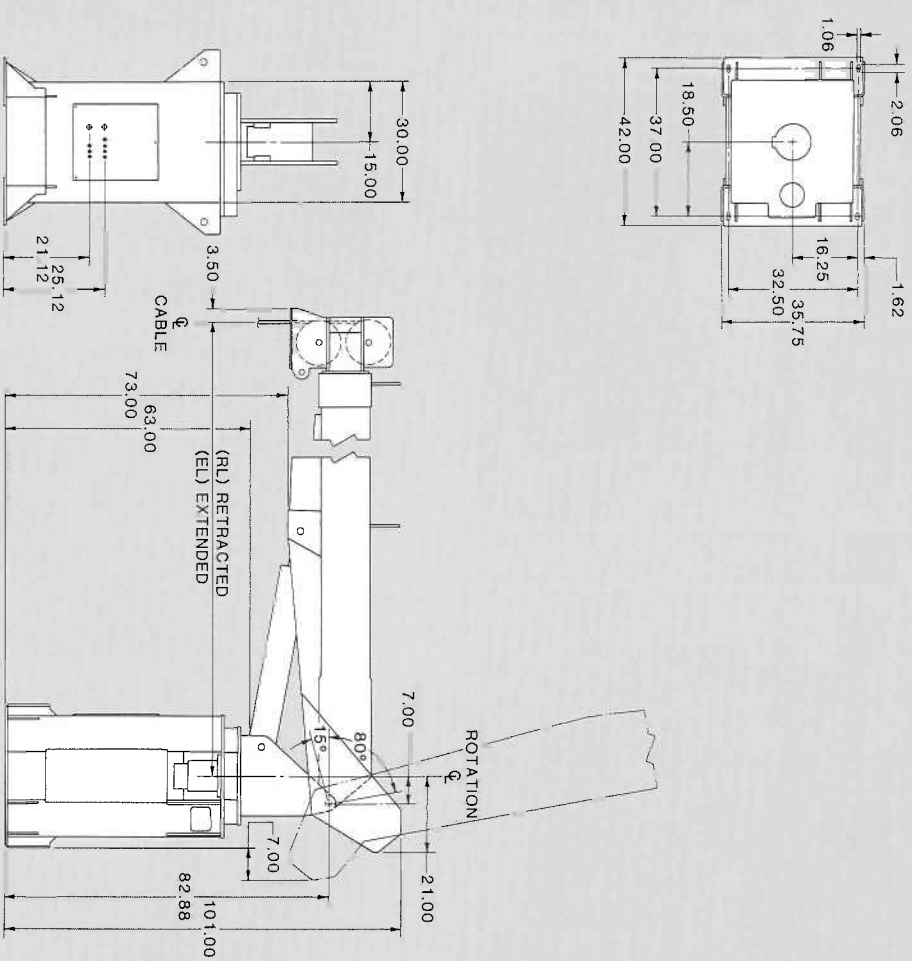

SERIES 800B

Load Moment at Mounting Surface

3,150,000 in-lb

Rotational Force

220,000 in-lb

Thrust Load at Mounting Surface

35,000 lbs.

Mounting Bolts and Nuts

1-8 UNC Grade 8, extending 2½" above the mounting surface. Torqued to 800 ft/lbs.

Rotational Stop Locations

Rotational stops which allow minimum of 60° rotation up to 375° rotation in any desired quadrant. Contact factory for details.

Weight

Model 839B: 7,950 lbs.
Model 856B: 9,050 lbs.
Model 875B: 10,900 lbs.

