



model 11000



product guide

- 100 ton Lift Capacity
- 2,350 ft-kips Maximum Load Moment
- 230' Heavy-Lift Boom
- 270' Fixed Jib on Heavy-Lift Boom
- 310' Luffing Jib on Heavy-Lift Boom
- 332 HP Engine
- 535 fpm Maximum Line Speed
- 25,100 lb Rated Line Pull
- 46,700 lb Maximum Line Pull
- 25,000 lb Material Rehandling Clamshell capacity
- Fast, efficient self-assembly and disassembly
- Manitowoc Crane CARE comprehensive support

contents

Specifications	3
Outline Dimensions	6
Transport Data	11
Self Assembly	12
Performance Data	13
Boom Combinations	14
Load Charts Notes	16
Range Diagrams and Load Charts	17
Clamshell	26



specifications

Upperworks



Engine

Hino P11C-UN, 6 cylinder, water-cooled diesel, direct fuel injection with turbocharger, 247 kW (332 HP) at 2000 high-idle RPM. Maximum torque 959 lb·ft (1300 N·m) net at 1,500 rpm (SAE J 1349).

One diesel fuel tank, 105 gallons (400 liters) capacity.

Two 12 volt 150 AH capacity batteries, 24 volt system and 80 amp alternator.

All wiring harnesses and connectors are numbered for easier servicing. Machine is equipped with individual fused branch circuits.



Controls

Full-flow hydraulic control system for constant variable pressure to front and rear drums, boom hoist brakes and clutches. Controls respond instantly to the touch, delivering smooth function operation.

Relief valve pressures:

Load hoist, boom hoist

and propel system4,480 psi (315 kg/cm²)

Swing system3,980 psi (280 kg/cm²)

Control system1,140 psi (80 kg/cm²)



Hydraulic System

All four variable displacement piston-type pumps are driven by a heavy-duty pump drive. One of these pumps is used in the right propel circuit and hook hoist circuit, and can accommodate an optional third circuit. Another is used in the left propel circuit and hook hoist circuit. The third variable displacement pump is used in the boom hoist circuit. The fourth variable displacement pump is used in the swing circuit. In addition, two gear pumps are used in the control system and auxiliary equipment, and two gear pumps serve the brake cooling system.

Maximum pressure rating 4,640 psi (325 kg/cm²)

Load hoist and propel 2 Piston pumps

Boom hoist 1 Piston pump

Swing 1 Piston pump

Control system and auxiliary 2 Gear pumps

Brake cooling system 2 Gear pumps

Reservoir capacity: 121 US gallon (460 liter).

Cooling: Oil-to-air heat exchanger (plate-fin type).

Filtration: Full-flow and bypass type with replaceable paper element.



Drums

Front and rear drums for load hoist powered by hydraulic variable displacement piston-type motors, driven through planetary reducers. Powered hoisting/lowering and free-fall operation is standard. Drum turn indicators for front and rear drums are also standard.

Brake & Clutches (compatible): Forced-circulation oil-cooled wet-type multi-disc brakes, each using positive and negative actuation. An external ratchet is fitted for locking the drums.

Drums: (front and rear) 24.1" (613 mm) P.C.D. X 24.5" (622 mm) wide drums, grooved for 1-1/16" (26.0 mm) wire rope.

Wire rope capacity:

Front drum 853 ft (260 m) working length

Rear drum 754 ft (230 m) working length

Line speed: Single line on the first drum layer

Hoisting394 ft/min (120m/min)

Lowering394 ft/min (120m/min)

▶ **Optional third drum:** same dimensions and specifications as front and rear drums (free-fall is optional). Wire rope capacity working length is 787' (240m).



Swing System

Swing unit: Powered by a hydraulic piston-type motor driving spur gears through planetary reducers, the swing system provides 360° rotation.

Swing brake: A spring-set, hydraulically released multiple-disc brake is internally fitted in swing motor.

Swing lock: 4 Position lock for transportation.

Rotating bed turntable: Single-row ball bearing with an integral internally cut swing gear.

Swing speed 2.7 rpm



Boom Hoist

Single drum powered by a hydraulic variable displacement piston motor through a planetary reducer.

Brake: A spring-set, hydraulically released multiple-disc brake is internally fitted in the boom hoist motor and operated through a counter-balance valve. An external ratchet is fitted for locking the drum.

Drum: Single drum, grooved for 13/16" (20 mm) diameter wire rope. Boom hoist reeving is 10-part line.

Wire rope capacity:

3

specifications

4

Drum 508 ft (155 m) working length.

Line speed: Single line on the first drum layer

Hoisting157 ft/min (48 m/min)

Lowering157 ft/min (48 m/min)



Gantry

This high folding type gantry is fitted with a sheave frame for boom hoist reeving. It provides full up, full down positions.



Counterweight

QTY.	ITEM	UNIT WEIGHT		TOTAL WEIGHT	
		kg	lb	kg	lb
1	Counterweight A	10 000	22,050	10 000	22,050
2	Counterweight B	7 000	15,435	14 000	30,870
1	Counterweight C	10 000	22,050	10 000	22,050
Counterweight TOTAL		34 000	74,970		



Operator's Cab

Totally enclosed, full vision cab fitted with tinted safety glass. A fully adjustable, highbacked seat with arm rests permits operators to set their ideal working position. Side mounted console for auxiliary controls and instruments. An air conditioner, a signal horn, cigarette lighter, windshield wiper and inspection lamp socket are standard features.

Controls

In front of operator are the foot pedals for front, rear and third drum (option) brakes and foot throttle pedal. At operator's right side are the travel (propel) control levers and the function lock lever. To the operator's right front are the boom hoist control lever, front and rear winch control levers and the free-fall select switches for the front and rear winches and drum turn indicators (front/rear drum). To the operators left front are the swing control lever and third drum (option) control lever. To the operator's left are the crawler extend/retract lever and the positive swing lock. The left-hand console contains switches for the anti-two-block/boom overhoist. Directly in front of the console are the drum pawl lock for boom, front, rear and third drum (option) and the engine ignition key. The swing brake and signal horn are mounted on the swing control lever.

Gauges

Fuel gauge, engine water temperature gauge, hour meter and tachometer are located on the monitor display.

Warning display

All potential warnings, including battery charge, engine oil pressure, air cleaner, engine oil filter, control main pressure, and hydraulic oil temperature will appear on the monitor display when a fault occurs.

Safety device

Function lock lever, anti-two-block, boom over hoist limit switch, boom angle indicator, signal horn, boom hoist drum lock, front and rear drum lock, swing lock, swing alarm (buzzer and lamps), boom backstops, safety latch on hook blocks, and load moment indicator.

Lowerworks



Carbody

The durable carbody features steel welded construction with extendible axles.



Crawlers

Crawler assemblies can be hydraulically extended for wide-track operation and are designed with a quick disconnect feature for individual removal as a unit from axles. Crawler belt tension adjusted with hydraulic jack and maintained by shims between idler block and frame. Self-erect system includes two sheaves for crawler, counterweight, and boom handling, plus jacking cylinders with pads.

Crawler drive

The independent hydraulic propel drive is built into each crawler side frame. Each drive consists of a hydraulic motor driving a propel sprocket through a planetary gearbox. The hydraulic motor and gearbox are built into the crawler side frame within the shoe width. The track rollers are sealed for maintenance-free operation.

Crawler brakes

Spring-set, hydraulically released, multiple disc-type parking brakes are built into each propel drive.

Steering mechanism

The hydraulic propel system provides both skid steering (driving one track only) and counter-rotating steering (driving each track in opposite direction) and differential track speed.

Crawler shoes

63 shoes per side, 36" (914 mm) wide each crawler.

Travel speed (High/Low) 0.87/0.62 mph (1.4/1.0 km/h)

Attachments



Boom

Welded lattice construction using tubular, high-tensile steel chords with pin connections between sections. Boom tip is open throat construction. Two idler sheaves and four point sheaves are standard.

specifications

Basic boom length 60' (18,3 m) consists of the boom butt section 10' 0" (3,0 m) insert and boom top section 25' 0" (7,62 m).

Optional boom inserts are available to provide extension capabilities. They also have welded lattice construction with tubular, high-tension steel chords and pin connections on each one of 10' (3,0 m), 20' (6,1 m), 40' (12,2 m) inserts.

Maximum total length of boom 230' (70,1 m).



Fixed Jib

The optional fixed jib employs welded lattice construction with tubular, high-tension steel chords with pin connections between sections.

Basic jib length 30' (9,14 m) consists of jib butt section 15' (4,57 m) and jib top section 15' (4,57 m).

Optional jib inserts of 10' (3,0 m) and 20' (6,1 m) are available for extension capabilities up to 70' (21,3 m).

Maximum total length of boom and jib 200' (61,0 m) + 70' (21,3 m) is 270' (82,3 m).



Luffing Jib

Optional: Components to make up 60' (18,3 m) basic luffing boom including 25' (7,62 m) butt, 30' (9,14 m) special luffing boom insert (with idler sheave), 5' (1,5 m) top, boom strut assembly, jib strut assembly, jib stop assembly, strut backstops, backstay pendants with sheaves, mounting parts and LMI hardware.

Optional: 10' (3,0 m) and 20' (6,1 m), and 40' (12,2 m) luffing boom inserts. Utilize optional boom inserts to make up to 150' (45,7 m) of luffing boom.

Optional: 60' (18,3 m) basic luffing jib assembly including 19' (5,8 m) luffing jib butt, 20' (6,1 m) luffing jib insert, 21' (6,4 m) luffing jib top, 21' (6,4 m) front strut assembly, 17' 5" (5,3 m) rear strut assembly, and luffing jib point roller assembly (single sheave) which is required during erection of the jib.

Maximum 170' (51,8 m) luffing jib length for 140' (42,7 m) luffing boom length and maximum 100' (30,4 m) luffing jib length for 150' (45,7 m) luffing boom length.

Note: Luffing boom utilizes the liftcrane boom inserts (except for the 30' special luffing boom insert). Also, the third drum and wire rope must be ordered with luffing jib attachment

Tools and Accessories

A set of tools and accessories are furnished.

Optional Equipment

Optional: Blocks and Hooks

Contact factory representative for hook and block options.

Travel kit
Detachable upper boom point
Custom color

5

outline dimensions

6

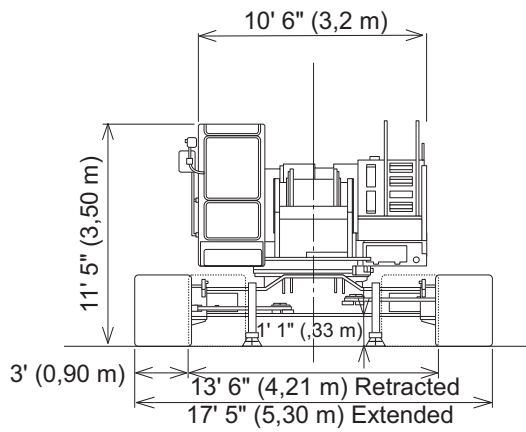
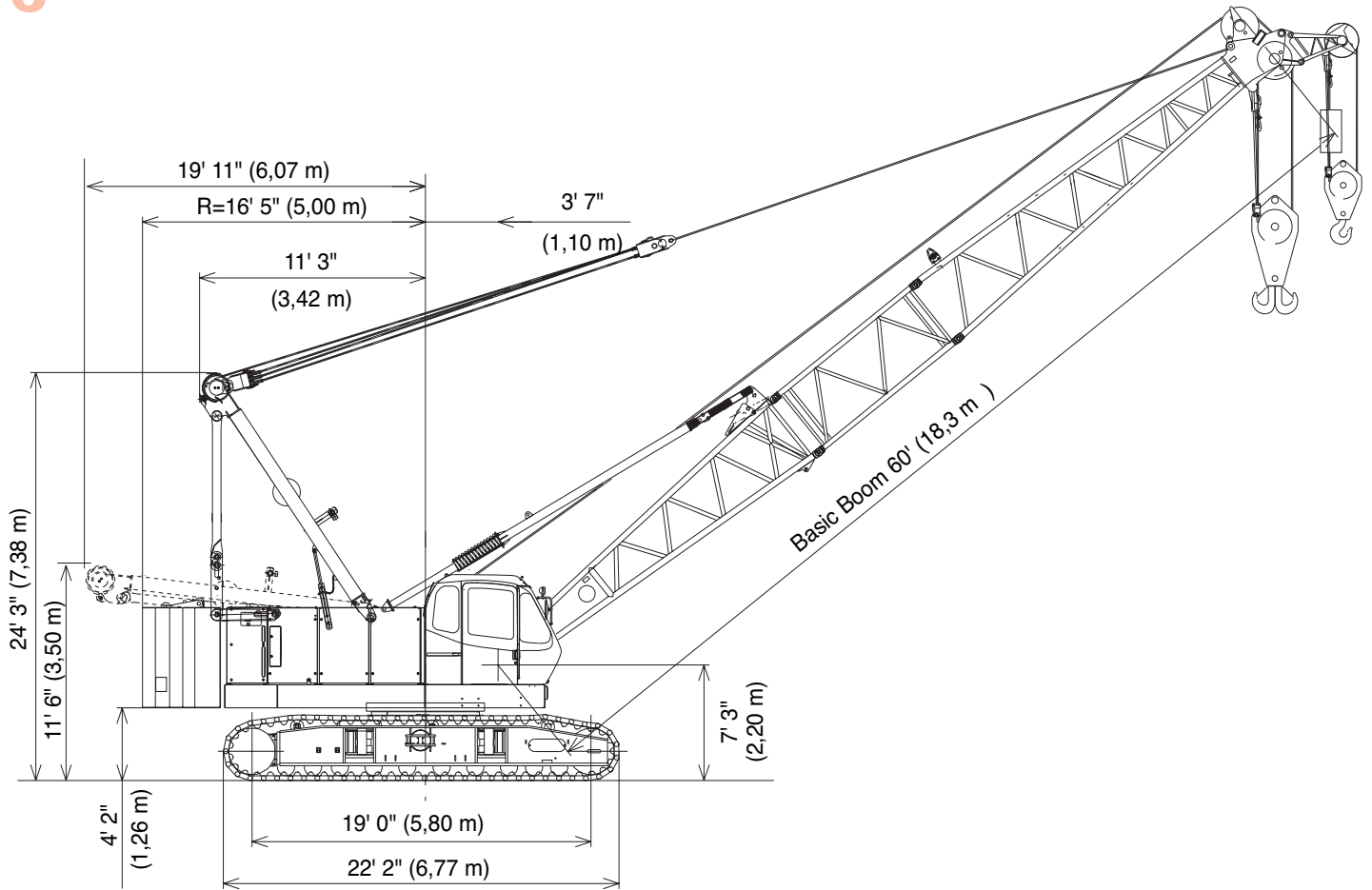

outline dimensions

7

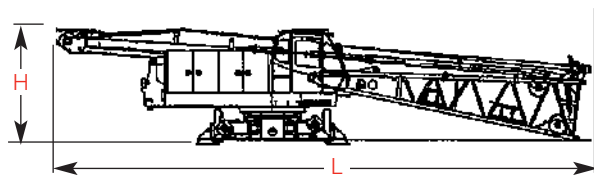

Upperworks without Crawlers x 1

Length	15,12 m	49' 7"
Width	3,24 m	10' 8"
Height	3,15 m	10' 4"
Weight	42 661 kg	94,052 lb

Note: Weight includes base machine, gantry, maximum hoist and whip lines on drums, boom butt, full hydraulic fluid reservoir, and one third tank of fuel.

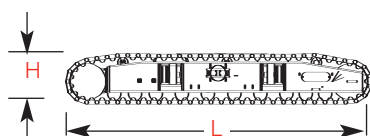

Crawlers x 2

Length	6,77 m	22' 3"
Width	0,90 m	3' 0"
Height	1,15 m	3' 9"
Weight	11 830 kg	26,085 lb

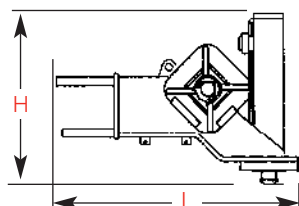

Hydraulic Jack

(if removed) x 4

Length	1,36 m	4' 5"
Width	0,32 m	1' 1"
Height	0,96 m	3' 2"
Weight	430 kg	950 lb

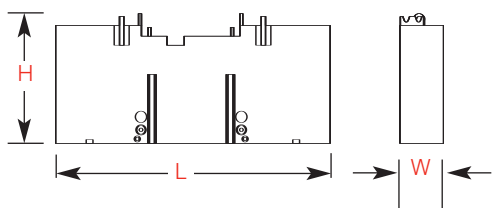

Upper Counterweight A x 1

Length	3,20 m	10' 5"
Width	0,58 m	1' 11"
Height	1,94 m	6' 4"
Weight	10 000 kg	22,050 lb

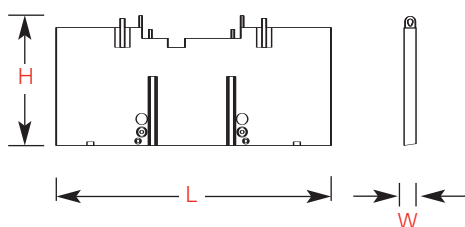

Upper Counterweight B x 2

Length	3,20 m	10' 5"
Width	0,49 m	1' 7"
Height	1,92 m	6' 3"
Weight	7 000 kg	15,435 lb

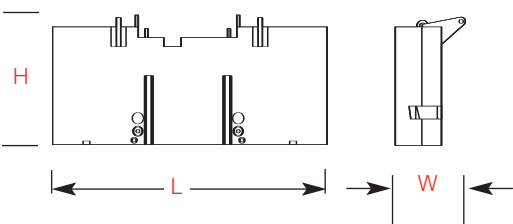

Upper Counterweight C x 1

Length	3,20 m	10' 5"
Width	0,69 m	2' 3"
Height	1,92 m	6' 3"
Weight	10 000 kg	22,050 lb

Optional 3rd Drum & Wire Rope x 1

Weight	2 660 kg	5,865 lb
--------	----------	----------

Option

outline dimensions

8

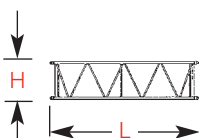
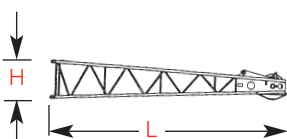
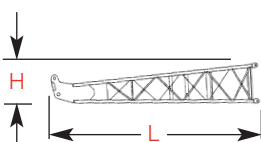
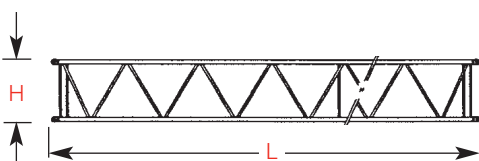
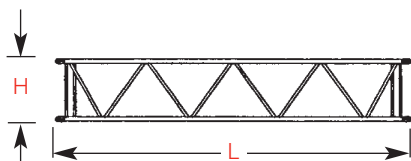
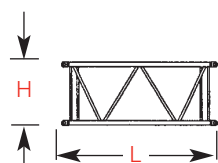
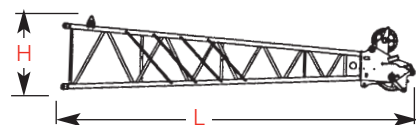
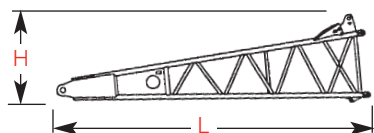

-Boom Butt 7.6m (25')		x 1
Length	7,79 m	26' 3"
Width	1,68 m	5' 6"
Height	2,06 m	6' 9"
Weight	2 110 kg	4,652 lb

Boom Top 7.6m (25')		x 1
Length	8,32 m	27' 4"
Width	1,68 m	5' 6"
Height	1,69 m	5' 7"
Weight	1 525 kg	3,362 lb

Boom Insert 3,0 m (10')		x 1, 2
Length	3,17 m	10' 5"
Width	1,68 m	5' 6"
Height	1,69 m	5' 7"
Weight	380 kg	838 lb

Boom Insert 6,1m (20')		x 1, 2
Length	6,22 m	20' 5"
Width	1,68 m	5' 6"
Height	1,69 m	5' 7"
Weight	655 kg	1,445 lb

Boom Insert 12,2 m (40')		x 1, 2, 3
Length	12,31 m	40' 5"
Width	1,68 m	5' 6"
Height	1,69 m	5' 7"
Weight	1 195 kg	2,635 lb

Note: Use one "A" type insert with lug required for any boom combinations that require a 12,2 m (40') insert.

Fixed Jib Butt		x 1
Length	4,81 m	15' 9"
Width	0,80 m	2' 8"
Height	0,80 m	2' 8"
Weight	200 kg	440 lb

Fixed Jib Top		x 1
Length	4,91 m	16' 1"
Width	0,80 m	2' 8"
Height	0,80 m	2' 8"
Weight	280 kg	617 lb

Fixed Jib Insert 3,0 m (10')		x 1, 2
Length	3,12 m	10' 3"
Width	0,80 m	2' 8"
Height	0,80 m	2' 8"
Weight	100 kg	220 lb

Option

outline dimensions

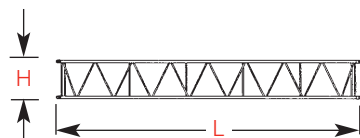

	Fixed Jib Insert 6,1 m (20')	x 1, 2
Length	6,16 m	20' 3"
Width	0,80 m	2' 8"
Height	0,80 m	2' 8"
Weight	180 kg	395 lb

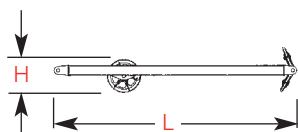

	Fixed Jib Strut	x 1
Length	3,62 m	11' 11"
Height	0,62 m	2' 0"
Weight	250 kg	550 lb

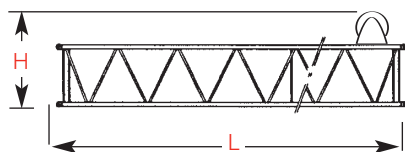

	Special Luffing Boom Insert 9,1 m (30')	x 1
Length	9,27 m	30' 5"
Width	1,68 m	5' 6"
Height	2,41 m	7' 11"
Weight	1 160 kg	2,558 lb

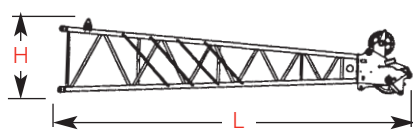

	Luffing Jib Top	x 1
Length	6,91 m	22' 8"
Width	1,50 m	4' 11"
Height	1,48 m	4' 10"
Weight	1 170 kg	2,580 lb

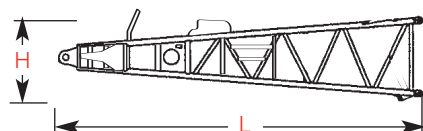

	Luffing Jib Butt	x 1
Length	5,97 m	19' 7"
Width	1,49 m	4' 11"
Height	1,32 m	4' 4"
Weight	863 kg	1,903 lb

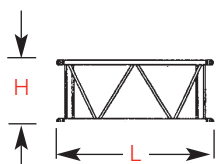

	Luffing Jib Insert 3,0 m (10')	x 1, 2
Length	3,16 m	10' 5"
Width	1,49 m	4' 11"
Height	1,29 m	4' 3"
Weight	310 kg	684 lb

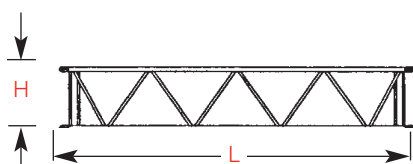

	Luffing Jib Insert 6,10 m (20')	x 1, 2
Length	6,21 m	20' 5"
Width	1,49 m	4' 11"
Height	1,29 m	4' 3"
Weight	540 kg	1,147 lb

 Option

9

outline dimensions

10

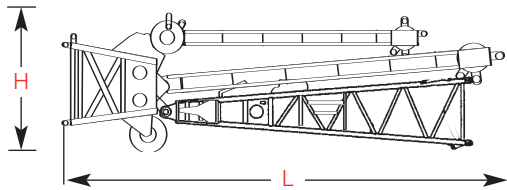
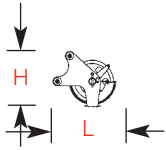
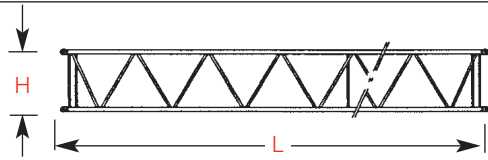

Luffing Jib Insert 12,2 m (40') x 1, 2, 3		
Length	12,31 m	40' 4"
Width	1,49 m	4' 11"
Height	1,29 m	4' 3"
Weight	960 kg	2,117 lb

Luffing Jib Point Roller Assembly x 1		
Length	1,01 m	3' 4"
Width	0,89 m	2' 11"
Height	0,91 m	3' 0"
Weight	380 kg	838 lb

Luffing Boom Top Assembly (Shipping Style) x 1		
Length	8,19 m	26' 10"
Height	2,65 m	8' 8"
Weight	3 580 kg	7,895 lb

Trailer Load Out Summary

Model 11000

No. 11000 Luffing Jib 39,6 m (130') on No. 260 Boom 38,1 m (125')

Weight
each Item Quantity on
Trailer Load #

Item	kg (lb)	1	2	3	4	5	6
No. 11000 Basic Crane with Crawlers Removed	42 661 (94,052)	1					
Crawler Frame	11 832 (26,085)		1				
Crawler Frame	12 832 (26,085)			1			
Counterweight A	10 000 (22,050)					1	
Counterweight B	7 000 (15,435)				1		
Counterweight B	7 000 (15,435)					1	
Counterweight C	10 000 (22,050)						1
12,2 m (40') No. 11000 Boom Insert, Pendants	1 209 (2,635)		1				
12,2 m (40') No. 11000 Boom Insert, Pendants	1 209 (2,635)			1			
12,2 m (40') No. 11000 Boom Insert, Pendants	1 209 (2,635)				1		
6,1 m (20') No. 11000 Boom Insert, Pendants	655 (1,445)					1	
6,1 m (20') No. 11000 Boom Insert, Pendants	655 (1,445)						1
3,0 m (10') No. 11000 Boom Insert, Pendants	380 (838)		1				
3,0 m (10') No. 11000 Boom Insert, Pendants	380 (838)					1	
Standard Boom Top 7,6 m (25')	1,525 (3,362)						1
Upper Boom Point	501 (1,105)			1			
4,6 m (15') No. 11000 Fixed Jib Top	280 (617)				1		
4,6 m (15') No. 11000 Fixed Jib Butt	134 (440)						1
6,1 m (20') No. 11000 Fixed Jib Insert	179 (395)				1		
6,1 m (20') No. 11000 Fixed Jib Insert	179 (395)						1
Approximate Total Shipping Weight kg (lb)		42 661 (94,052)	13 594 (29,558)	13 528 (29,825)	8 655 (19,082)	18 038 (39,768)	12 561 (27,692)

self assembly

12

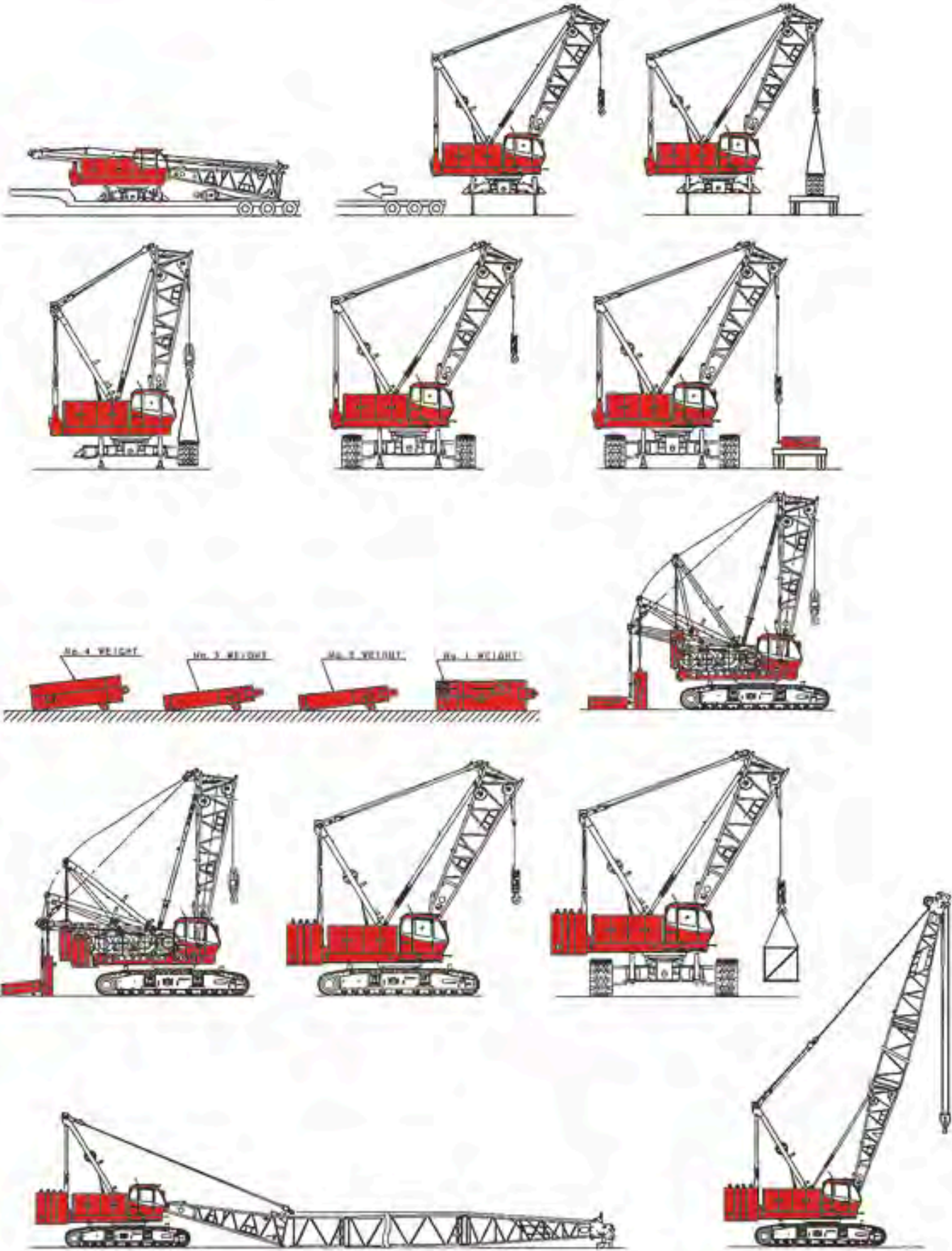

performance data

13

Line Pull

	Rated line pull	* Maximum line pull
Front Drum	25,100 lbs (11 400 kg)	46,700 lbs (21 180 kg)
Rear Drum	25,100 lbs (11 400 kg)	46,700 lbs (21 180 kg)
Optional 3rd Drum	25,100 lbs (11 400 kg)	46,700 lbs (21 180 kg)

* Maximum line pull is not based on wire rope strength.

Wire Rope Specifications

Use	Specs	Diameter inch (mm)	Working Length feet (m)	Breaking Strength lbs (kg)
Front Drum	IWRC 6 X Fi (29) C/O	1-1/16" (26,0)	853' (260)	120,000 (54 431)
Rear Drum	IWRC 6 X Fi (29) C/O	1-1/16" (26,0)	754' (230)	120,000 (54 431)
Boom Hoist Drum	IWRC 6 X WS (31) C/O	13/16" (20,0)	508' (155)	73,700 (33 430)

Model 11000 Front and Rear Winch Performance (Optional: Third Winch)

Line speed (ft/min)							
Layer	1	2	3	4	5	6	
Line Pull (lbs)							
0	394	422	450	479	505	535	
5,000	387	415	443	471	499	526	
10,000	353	353	353	353	353	353	
15,000	235	235	235	235	235	235	
20,000	117	117	117	117	117	117	
Rated Line pull	25,000	141	141	141	141	141	142
	30,000	118	118	119	121	122	123
	35,000	103	104	105	105		
	40,000	92	92				

Line speed (m/min)							
Layer	1	2	3	4	5	6	
Line Pull (kg)							
0	120	129	137	146	155	163	
2 268	118	126	135	143	152	160	
4 536	108	108	108	108	108	108	
6 804	72	72	72	72	72	72	
9 072	52	52	52	52	52	52	
Rated Line pull	11 340	43	43	43	43	43	43
	13 608	36	36	36	37	37	37
	15 876	31	32	32	32		
	18 144	28	28				

Note:
Line speeds and line pull based on single line.
Line pulls are not based on wire rope strength.

boom combinations

14

No. 11000 Heavy-Lift Boom Combinations

Boom Length m (ft)	Boom Inserts		
	3,1 m (10 ft)	6,1 m (20 ft)	12,2 m (40 ft)
18,3 (60)	1	-	-
21,3 (70)	2	1	-
24,4 (80)	1	1	-
27,4 (90)	2	1	-
30,5 (100)	1	2	-
33,5 (110)	2	2	-
36,6 (120)	1	1	1*
39,6 (130)	2	1	1*
42,7 (140)	1	2	1*
45,7 (150)	2	2	1*
48,8 (160)	1	1	2*
51,8 (170)	2	1	2*
54,9 (180)	1	2	2*
57,9 (190)	2	2	2*
61,0 (200)	1	1	3*
64,0 (210)	2	1	3*
67,0 (220)	1	2	3*
70,1 (230)	2	2	3*

*Note: One 40 ft. (12,2 m) boom insert with lug (40A) is required for fixed jib. When no jib is installed a 40 ft (12,2 m) boom can be used instead of 40A.

No. 11000 Fixed Jib Combinations

Jib Length m (ft)	Fixed Jib Inserts	
	3,1m (10 ft)	6,1m (20 ft)
9,1 (30)	-	-
12,2 (40)	1	-
15,2 (50)	-	1
18,3 (60)	1	1
21,3 (70)	-	2

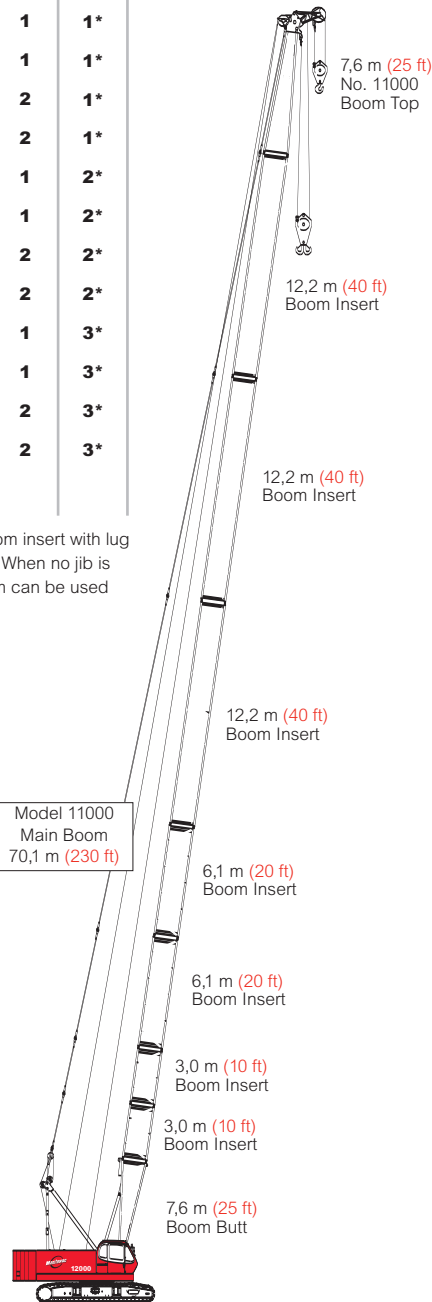

**Model 11000
Main Boom
70,1 m (230 ft)**

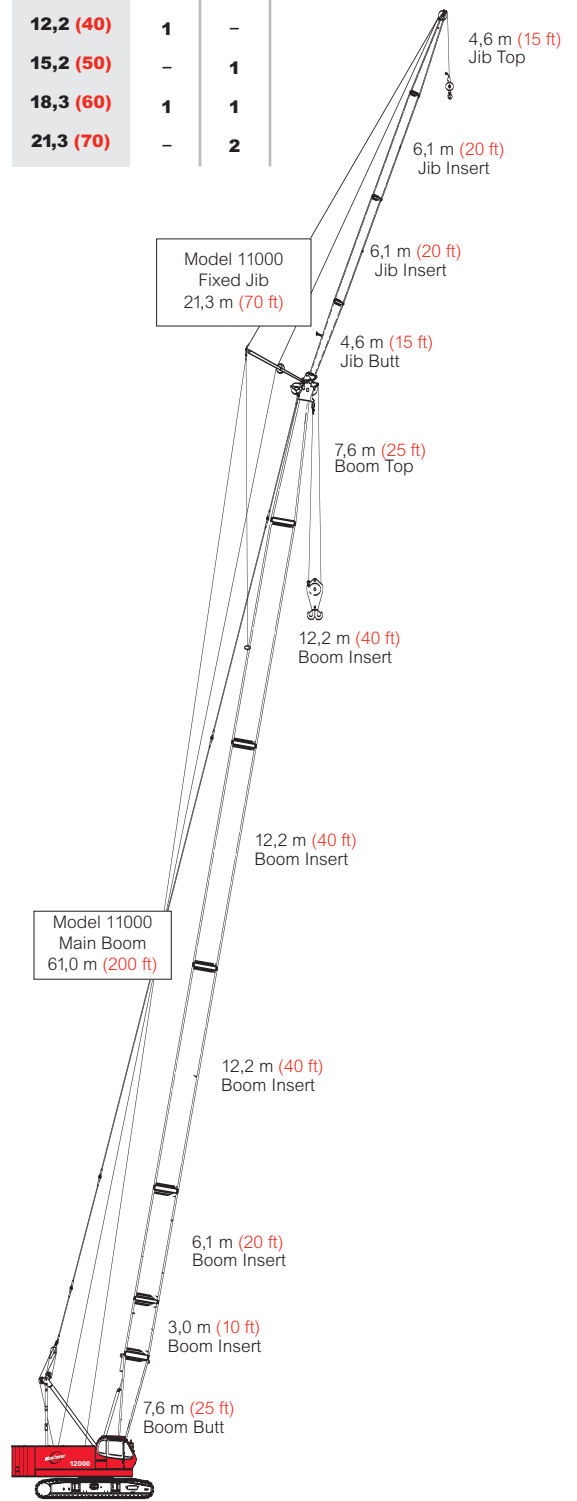

**Model 11000
Fixed Jib on Main Boom
82,3 m (270 ft)**

boom combinations

No. 11000 Luffing Jib Combinations

Luffing Jib Length m (ft)	Boom Inserts		
	3,0 m (10 ft)	6,1 m (20 ft)	12,2 m (40 ft)
18,3 (60)	-	-	-
21,3 (70)	1	-	-
24,4 (80)	2	-	-
27,4 (90)	1	1	-
30,5 (100)	2	1	-
33,5 (110)	1	-	1
36,6 (120)	2	-	1
39,6 (130)	1	1	1
42,7 (140)	2	1	1
45,7 (150)	1	-	2
48,8 (160)	2	-	2
51,8 (170)	1	1	2

No. 11000 Luffing Boom Combinations

Luffing Boom Length m (ft)	Boom Inserts			
	3,0 m (10 ft)	6,1 m (20 ft)	9,1 m (30 ft)	12,2 m (40 ft)
18,3 (60)	-	-	1*	-
21,3 (70)	1	-	1*	-
24,3 (80)	2	-	1*	-
27,4 (90)	1	1	1*	-
30,5 (100)	2	1	1*	-
33,5 (110)	1	2	1*	-
36,6 (120)	2	2	1*	-
39,6 (130)	1	1	1*	1
42,7 (140)	2	1	1*	1
45,7 (150)	1	2	1*	1

*Note: One 9,14 m (30') special luffing boom insert is required for luffing boom.

15

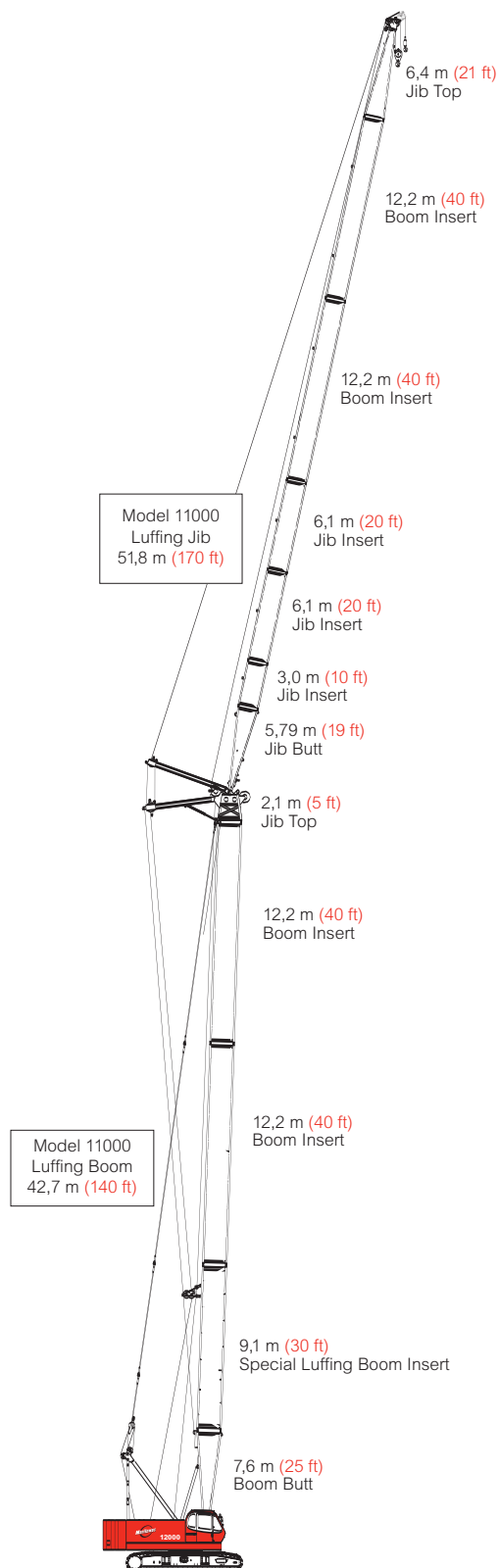

Model 11000
Luffing Jib on
Luffing Boom
94,5 m (310 ft)

load charts notes

16

- Rated loads included in the charts are the maximum allowable freely suspended loads at a given boom length, boom angle and load radius, and have been determined for the machine standing level on firm supporting surface under ideal operating conditions. The user must limit or de-rate rated loads to allow for adverse conditions (such as soft or uneven ground, out-of-level conditions, wind, side loads, pendulum action, jerking or sudden stopping of loads, inexperience of personnel, multiple machine lifts, and traveling with a load).
- Capacities do not exceed 75% of minimum tipping loads. Capacities based on factors other than machine stability such as structural competence are shown by asterisk * in the charts located in the operator's crane cab.
- The machine must be reeved and set-up as stated in the operation manual and all the instruction manuals. If these manuals are missing, obtain replacements. Boom backstops are required for all boom lengths. Gantry must be in the fully raised position for all operations. Crawlers must be fully extended and be locked in position. The crane must be leveled to within 1% on a firm supporting surface.
- Do not attempt to lift where no radius or load is listed as crane may tip or collapse.
- Attempting to lift more than rated loads may cause machine to tip or collapse. Do not tip machine to determine capacity.
- Weight of hooks, hook blocks, slings and other lifting devices are a part of the total load. Their total weight must be subtracted from the rated load to obtain the weight that can be lifted.
- When lifting over boom point with jib or upper boom point installed, rated loads for the boom must be deducted as shown below.

Jib length	Upper Boom Point	30'	40'	50'	60'	70'
Deduct (lbs)	700	2,400	3,200	4,200	5,200	6,200

When lifting over luffing jib point with luffing jib roller assembly or pin connected boom point sheave (on the luffing boom top) attached, rated loads for the jib and sheave must be deducted as shown below.

	Luffing Jib Point Roller	Pin Connected Boom Point Sheave
Deduct (lbs)	850	480

- The total load that can be lifted by the fixed jib is limited by rated jib loads. The total load that can be lifted with the upper boom point is limited by rated upper boom point loads.
- Boom lengths for fixed jib mounting are 90 ft (27,4 m) to 200 ft (61,0 m).
- The total load that can be lifted by the upper boom point is: the rated load for the luffing jib (without upper boom point installed) minus 850 lbs; however, the upper boom point rated load should not exceed 25,000 lbs.

- An upper boom point cannot be used on a 230 ft (70,1 m) boom length.
- The boom should be erected over the front of the crawlers, not laterally.
- Least stable position is over the side.
- Maximum hoist load for number of reeving parts of line for hoist rope.

Maximum Load for Main Boom

No. of Parts of Line	1	2	3	4	5
Maximum Loads (lbs)	25,000	50,000	75,000	100,000	125,000

No. of Parts of Line	6	7	8
Maximum Loads (lbs)	150,000	175,000	200,000

Maximum Load for Luffing Jib

No. of Parts of Line	1	2	3	4
Maximum Loads (lbs)	25,000	50,000	75,000	80,000

Maximum Load for Fixed Jib

No. of Parts of Line	1
Maximum Loads (lbs)	24,000

Maximum Load for Upper Boom Point (On Liftcrane Boom)

No. of Parts of Line	1	2
Maximum Loads (lbs)	25,000	50,000

Maximum Load for Upper Boom Point (On Luffing Jib)

No. of Parts of Line	1
Maximum Loads (lbs)	25,000

Minimum Weight of Hook Block Required for Lowering. (Luffing Jib Use)

No. of Parts of Line	1	2	3	4
Maximum Loads (lbs)	900	1,200	1,500	1,800

- Lifting capacities listed apply only to the machine as originally manufactured for and supplied by Manitowoc Cranes, Inc. Modifications to this machine or use of equipment other than that specified can reduce operating capacity.
- Designed and rated to comply with ANSI Code B30.5.

Operation of this equipment in excess of rated loads or disregard of instruction voids the warranty.

heavy-lift boom range diagram

No. 11000 Main Boom

17

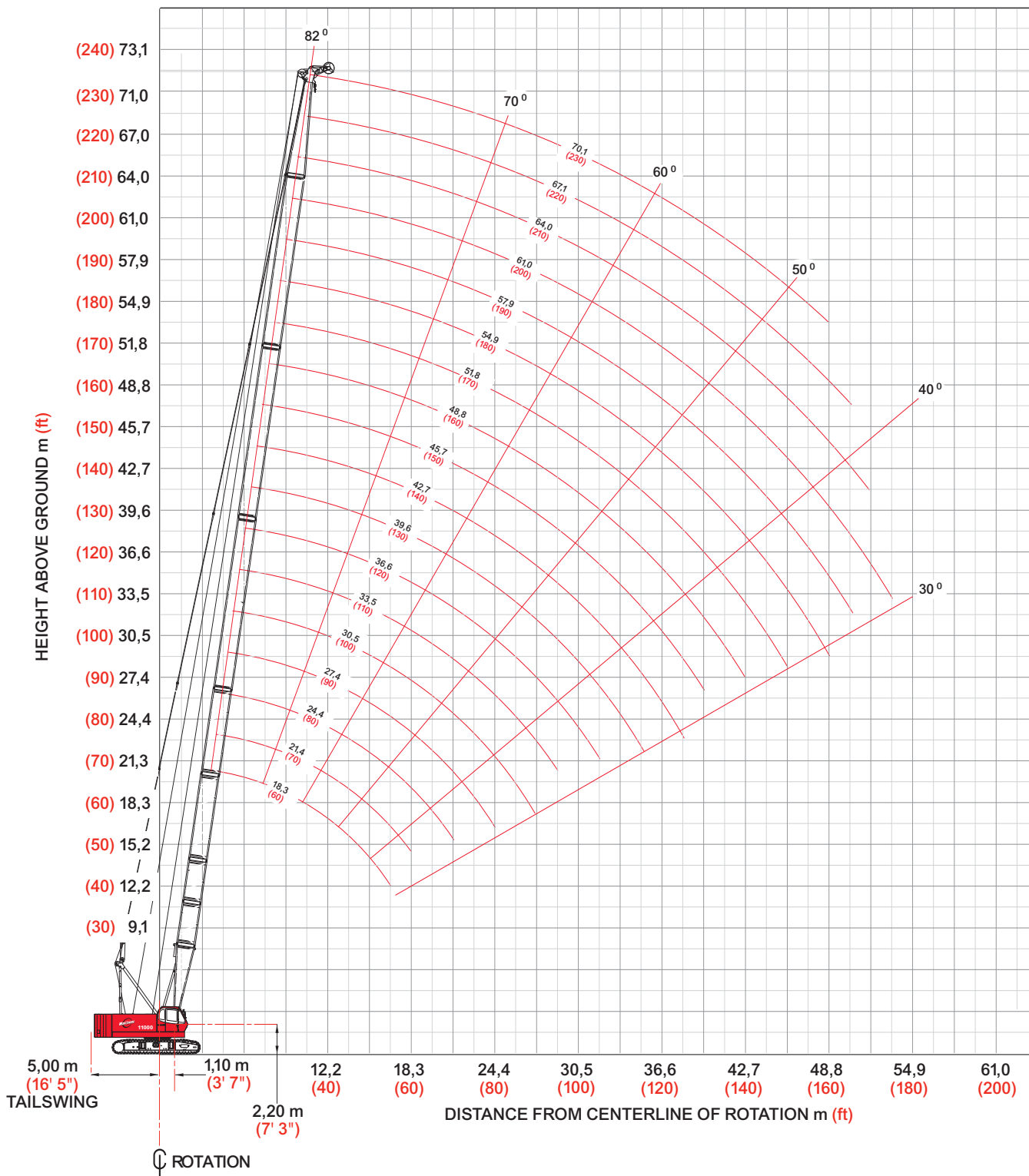

heavy-lift boom load charts

Liftcrane Boom Capacities No. 11000 Main Boom

75,000 lb Upper Counterweight

360° Rating

lb x 1 000

18

Boom ft	60	70	80	90	100	110	120	130	140	150	160	170	180	190	200	210	220	230
Radius																		
12																		
14	200.0																	
16	177.0	177.0																
18	150.0	150.0	150.0	150.0														
20	135.0	135.0	135.0	135.0	135.0													
24	111.7	111.7	111.5	111.5	111.3	111.3	111.1	100.0										
28	89.2	89.0	88.8	88.8	88.6	88.4	88.4	88.1	87.9	87.7								
34	68.1	67.9	67.4	67.4	67.2	67.0	67.0	66.7	66.5	66.3	66.3	66.1	65.9	65.4				
40	54.6	54.4	54.2	54.0	53.7	53.5	53.5	53.3	53.1	52.6	52.9	52.4	52.2	52.0	50.0	50.0	46.7	42.7
45	46.7	46.5	46.2	46.0	45.8	45.6	45.6	45.4	45.1	44.7	44.9	44.5	44.3	44.0	44.0	43.8	43.4	40.1
55	36.1	35.9	35.4	35.4	35.0	34.8	34.8	34.6	34.3	33.9	33.9	33.7	33.2	33.0	33.0	32.8	32.6	32.1
75				23.5	23.1	22.9	22.7	22.4	22.2	21.8	21.8	21.6	21.1	20.9	20.9	20.7	20.2	20.0
95						16.5	16.3	16.0	15.6	15.4	15.4	14.9	14.7	14.3	14.3	14.1	13.8	13.4
105							14.1	13.8	13.4	13.2	13.2	12.7	12.3	12.1	12.1	11.9	11.4	11.2
115								12.1	11.6	11.2	11.2	11.0	10.5	10.1	10.3	9.9	9.7	9.2
125									10.3	9.9	9.7	9.4	9.0	8.8	8.8	8.3	7.9	7.4
135											8.5	8.1	7.7	7.2	7.2	6.8	6.6	6.1
145												7.0	6.6	6.1	6.1	5.7	5.2	4.8
155													5.7	5.2	5.0	4.6	4.4	3.9
165														4.4	4.1	3.7	3.5	
175															3.5			

model 11000



Meets ANSI B30.5 Requirements - Capacities do not exceed 75% of static tipping load.
NOTICE: This capacity chart is for reference only and must not be used for lifting purposes.

fixed jib range diagram

No. 11000 Fixed Jib on Main Boom

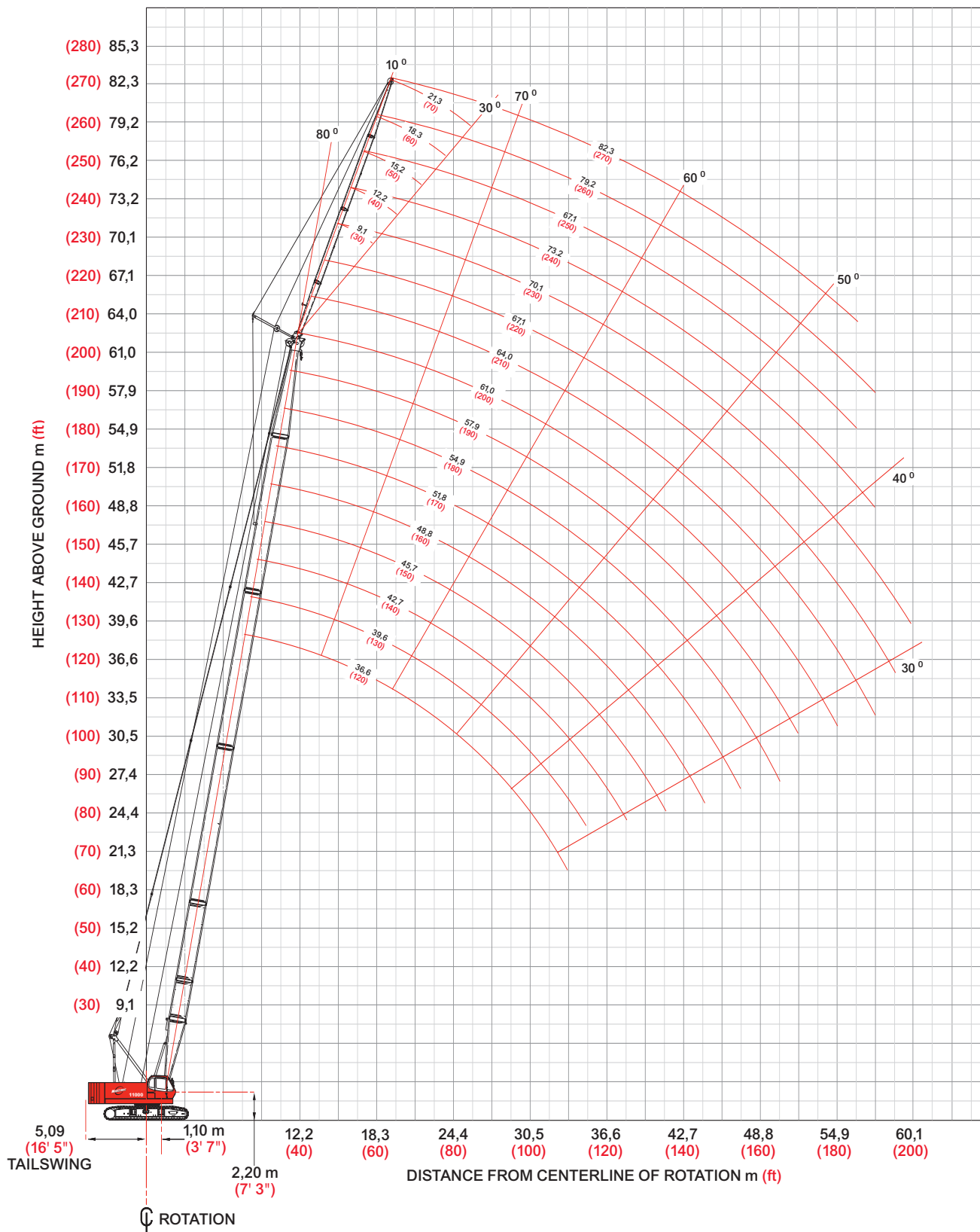

fixed jib load charts

20

Liftcrane Jib Capacities No. 11000 Fixed Jib on Main Boom

75,000 lb Counterweight (4 Upper Counterweights, Crawler Extended)

360° Rating

lb x 1 000

10° Offset

30° Offset

Boom ft	90	120	160	180	200
Radius					
30	24.0				
40	24.0	24.0			
50	24.0	24.0	24.0	24.0	24.0
60	24.0	24.0	24.0	24.0	24.0
80	21.9	21.1	20.1	19.8	19.0
100	16.1	15.3	14.2	13.6	13.1
120		11.6	10.4	9.8	9.3
140			7.8	7.1	6.5
160			5.8	4.9	4.2
175				3.6	
185					

Boom ft	90	120	160	180	200
Radius					
30					
40	21.0				
50	21.0	21.0			
60	21.0	21.0	21.0	21.0	21.0
80	18.9	20.8	20.8	20.2	19.9
100		15.6	14.7	14.1	13.7
120			10.7	10.2	9.7
140				7.4	7.0
160					
175					
185					

Boom ft	90	120	160	180	200
Radius					
30					
40	20.0				
50	20.0	20.0	20.0		
60	20.0	20.0	20.0	20.0	20.0
80	16.8	19.5	20.0	20.0	19.7
100	13.6	15.7	14.7	14.1	13.6
120	11.5	11.9	10.8	10.2	9.8
140		9.3	8.2	7.5	7.1
160			6.2	5.4	4.7
175			4.9	4.0	3.3
185			4.1		

Boom ft	90	120	160	180	200
Radius					
30					
40					
50					
60	11.4	11.4			
80	11.2	11.2	11.4	11.4	11.4
100	9.8	10.6	11.4	11.4	11.4
120		9.6	10.4	10.8	10.6
140			8.6	8.1	7.7
160				5.9	5.3
175					3.8
185					

model 11000



Meets ANSI B30.5 Requirements - Capacities do not exceed 75% of static tipping load.
NOTICE: This capacity chart is for reference only and must not be used for lifting purposes.

fixed jib load charts

Liftcrane Jib Capacities No. 11000 Fixed Jib on Main Boom

75,000 lb Counterweight (4 Upper Counterweights, Crawler Extended)

360° Rating lb x 1 000

		10° Offset					30° Offset				
		90	120	160	180	200	90	120	160	180	200
Jib 70 ft	Boom ft										
	Radius										
	45	15.7									
	60	14.8	15.1	15.4	15.6	15.7					
	75	13.9	14.4	14.8	15.0	15.1	8.1	8.1			
	90	11.5	13.3	14.3	14.4	14.6	7.6	8.1	8.1	8.1	8.1
	110	9.4	10.9	12.7	12.3	11.9	6.5	7.0	7.6	7.8	8.0
	130	7.9	9.2	9.7	9.1	8.6		6.3	6.9	7.1	7.3
	145	7.1	8.2	7.9	7.2	6.8		5.9	6.4	6.6	6.8
	170		6.8	5.6	4.7	4.1			5.9	5.5	4.9
	180			4.8	3.9					4.5	3.9
	190			4.0							
200			3.3								

Meets ANSI B30.5 Requirements - Capacities do not exceed 75% of static tipping load.
NOTICE: This capacity chart is for reference only and must not be used for lifting purposes.

luffing jib range diagram

No. 11000 Luffing Jib on Luffing Boom

22

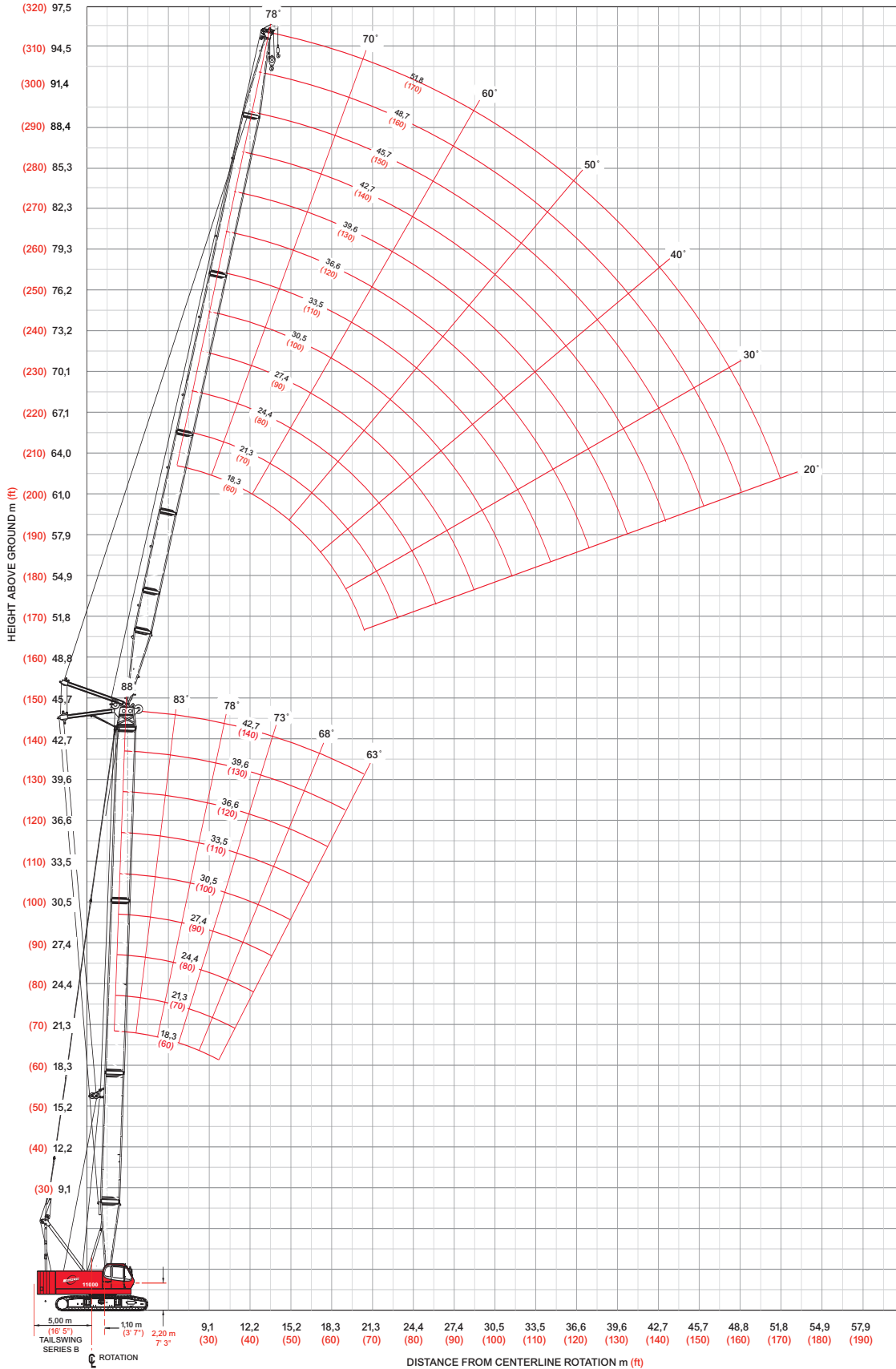

Luffing jib load charts

Liftcrane Luffing Jib Capacities No. 11000 Luffing Jib on Luffing Boom

75,000 lb Upper Counterweights (Crawlers Extended)

360° Rating

lb x 1 000

88° Boom Angle

23

Luffing Jib Length 60 ft	Boom ft	60	80	100	120	150
	Radius					
26		80.0	80.0			
30		69.3	69.3	69.3	69.3	42.5
36		57.7	57.7	57.7	57.7	36.4
45		46.2	46.2	46.2	46.2	29.1
65			26.9	27.3	27.6	18.3
80						
100						
120						
145						
165						

Luffing Jib Length 100 ft	Boom ft	60	80	100	120	150
	Radius					
26						
30						
36		57.7				
45		46.2	46.2	46.2	46.2	28.4
65		28.0	28.4	28.9	29.1	19.0
80		20.3	20.3	20.5	20.7	14.3
100		13.7	13.7	13.7	13.9	9.7
105						8.8
135						
165						

Luffing Jib Length 130 ft	Boom ft	60	80	100	120
	Radius				
45		46.2	46.2	46.2	
55		36.8	37.5	37.5	36.4
75		22.7	22.9	23.1	23.4
95		15.2	15.4	15.4	15.7
115		10.6	10.6	10.6	10.8
130		8.2	8.2	8.2	8.2
150					
165					
175					
190					

Luffing Jib Length 170 ft	Boom ft	60	80	100	120
	Radius				
45					
55		30.0	30.2		
75		21.6	21.8	22.0	22.3
95		14.1	14.3	14.3	14.6
115		9.7	9.7	9.7	9.7
130		7.3	7.3	7.3	6.2
150		4.9	4.0		
165		2.2			
175					
190					

Meets ANSI B30.5 Requirements - Capacities do not exceed 75% of static tipping load.
NOTICE: This capacity chart is for reference only and must not be used for lifting purposes.

Luffing jib load charts

24

Liftcrane Luffing Jib Capacities No. 11000 Luffing Jib on Luffing Boom

75,000 lb Upper Counterweights (Crawlers Extended)

360° Rating

lb x 1 000

73° Boom Angle

Luffing Jib Length	60 ft	80	100	120	150
	Radius				
55	35.9				
65	29.1	27.6			
75	24.0	23.1	22.3	20.3	
85		19.6	18.7	17.9	15.4
95				15.2	13.9
105					11.9
115					
125					
135					
140					

Luffing Jib Length	60	80	100	120	150
	Radius				
55					
65					
75					
85	19.6	17.9			
95	16.8	15.9	15.0	13.0	
105	14.6	13.7	13.0	12.1	9.3
115	12.8	11.9	11.2	10.4	9.0
125			9.9	9.0	7.7
135				7.9	6.6
140					6.2

Luffing Jib Length	60	80	100	120
	Radius			
95	15.2			
105	13.9	13.0	11.2	
115	12.1	11.2	10.6	9.3
125	10.6	9.9	9.3	8.2
135	9.3	8.6	7.9	7.1
145	8.2	7.7	6.8	6.2
155			6.0	5.3
160				4.9
175				
185				

Luffing Jib Length	60	80	100	120
	Radius			
95				
105				
115	10.1			
125	9.5	8.4	6.6	
135	8.4	7.5	6.6	4.9
145	7.1	6.4	5.5	4.6
155	6.2	5.5	4.6	4.0
160	5.7	5.1	4.2	3.5
175	4.6	4.0	3.3	
185		3.3		

model 11000



Meets ANSI B30.5 Requirements - Capacities do not exceed 75% of static tipping load.
NOTICE: This capacity chart is for reference only and must not be used for lifting purposes.

luffing jib load charts

Liftcrane Luffing Jib Capacities No. 11000 Luffing Jib on Luffing Boom

75,000 lb Upper Counterweights (Crawlers Extended)

360° Rating

lb x 1 000

63° Boom Angle

25

Luffing Jib Length 60 ft	Boom ft	60	80	100	120	150
	Radius					
75		22.5				
80		21.2				
85		19.4	17.6			
95			15.7	13.7		
105				12.3	10.4	
115					9.7	6.4
125						6.4
135						
145						
150						

Luffing Jib Length 100 ft	Boom ft	60	80	100	120	150
	Radius					
75						
80						
85						
95						
105		13.4				
115		11.7	10.6			
125		10.4	9.3	7.9		
135			8.2	7.1	5.3	
145				6.2	4.9	
150					4.4	

Luffing Jib Length 130 ft	Boom ft	60	80	100	120
	Radius				
120		9.7			
125		9.7			
130		9.0	7.1		
140		7.9	6.8	4.6	
150		7.1	6.0	4.6	
160			5.1	4.0	
170				3.3	
175				3.1	
180					
190					

Luffing Jib Length 170 ft	Boom ft	60	80	100	120
	Radius				
120					
125					
130					
140					
150		5.1			
160		4.9			
170		4.0			
175		3.7			
180		3.3			
190		2.9			

Meets ANSI B30.5 Requirements - Capacities do not exceed 75% of static tipping load.
NOTICE: This capacity chart is for reference only and must not be used for lifting purposes.

clamshell

26

Boom:

Welded lattice construction using tubular, high-tensile steel chords with pin connections between sections.
 Basic boom length: 60 ft (18,3 m)
 Max. boom length: 100 ft (30,5 m)
 Limit on clamshell bucket weight: 4,600 lbs (2 100 kg)

Boom Component Chart

Boom length ft (m)	Boom arrangement
60 (18,3)	Base-A-Tip
70 (21,3)	Base-A-A-Tip, Base-B-Tip
80 (24,4)	Base-A-B-Tip
90 (27,4)	Base-A-A-B-Tip, Base-B-B-Tip, Base-C-Tip
100 (30,5)	Base-A-B-B-Tip, Base-A-C-Tip

Base = 25 ft (7,6 m)
 Insert: A = 10 ft (3,05 m)
 B = 20 ft (6,10 m)
 C = 40 ft (12,2 m)
 Tip = 25 ft (7,2 m)

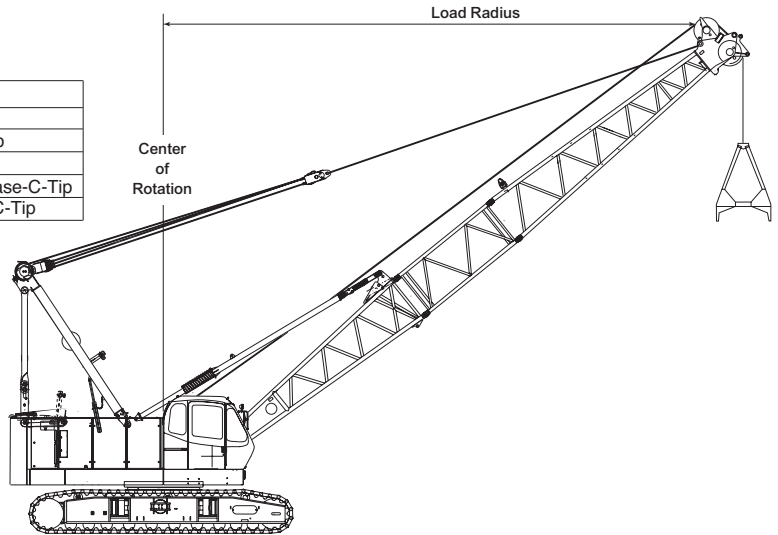

1. Figures represent maximum allowable capacity, and assume level ground and ideal working conditions.
2. Capacities are calculated at 66% of the minimum tipping loads.
3. Capacities are maximum recommended by PCSA Standard #4. Allowances must be made by the user for such unfavorable conditions as a soft or uneven supporting surface, rapid cycle operations, or bucket suction.
4. The combined weight of the bucket and load must not exceed these capacities.
5. Boom length for clamshell operation should not exceed 100 ft (30,5 m).

Clamshell Capacities

22,050 lb Counterweight (One Upper Counterweight, Crawlers Extended)

lb x 1 000

Boom ft	60	70	80	90	100
Radius					
22					
26					
30	25.0				
34	25.0	25.0			
45	22.9	22.7	22.5	21.6	
50	19.8	19.6	19.4	19.2	18.5
55	17.4	17.2	17.0	16.8	16.5
60		15.2	15.0	14.8	14.6
70			11.9	11.7	11.5
80				9.5	9.3
85					8.4
90					7.7

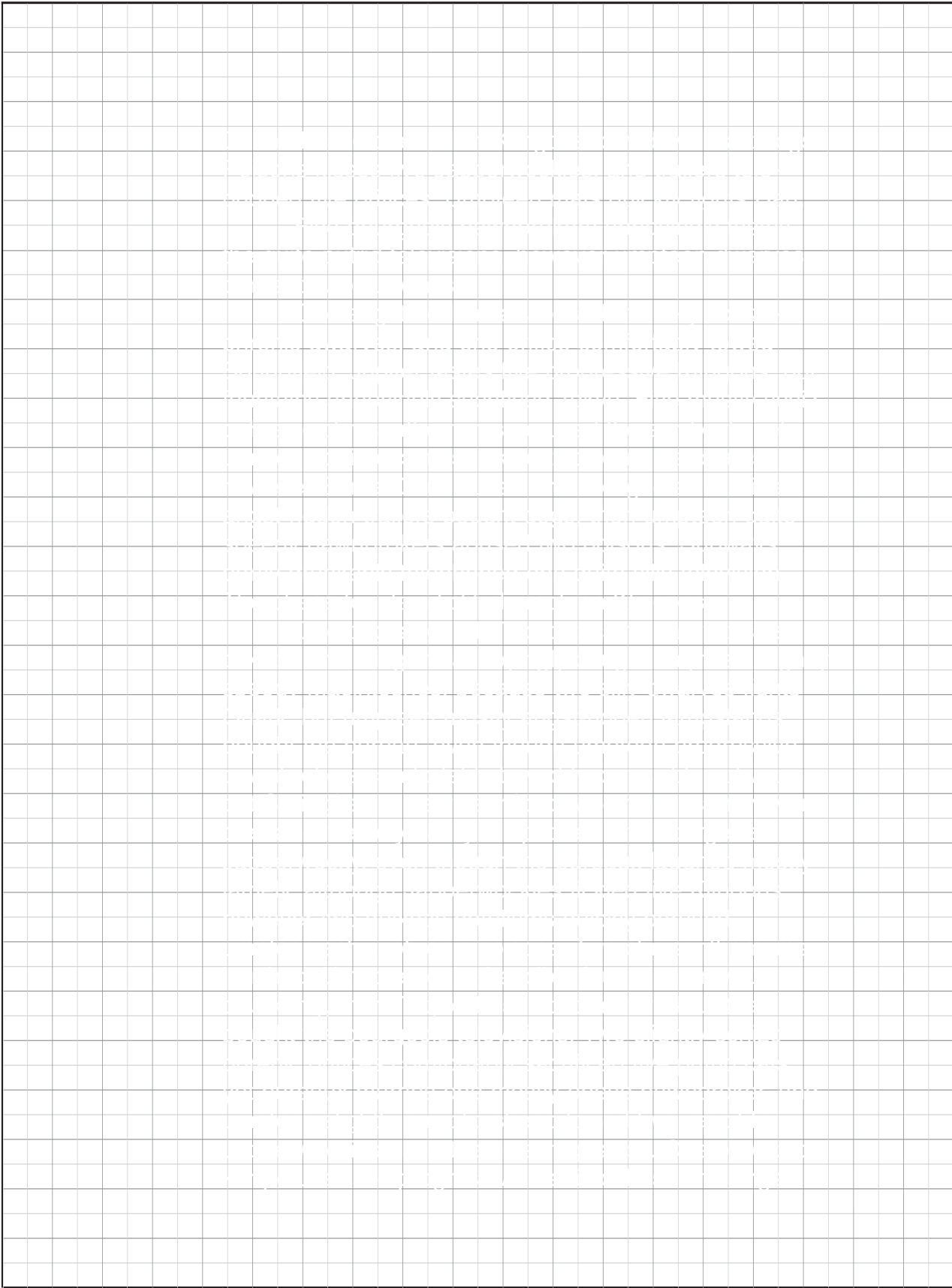



Americas Region

Manitowoc

Telephone Number: + 1 920 684 6621
Fax Number: + 1 920 683 6278
Address: 2401 S. 30th Street,
Manitowoc, WI 54220 USA

Grove, National, Manlift, Potain

Telephone Number: + 1 717 597 8121
Fax Number: + 1 717 593 5929
Address: 1565 Buchanan Trail East,
Shady Grove, PA 17256 USA

Manitowoc Crane Group - Brazil

Telephone Number: +55 11 3841 2741
Fax Number: +55 11 3841 2740
Address: Edificio: Itaim Office Tower
Rua Gomes de Carvalho,
1581 - 2 andar cj 205 / 206
Vila Olimpia - SP - Cep: 04547 - 006 Brasil

Grove - Mexico

Fax Number: +5281 8124 0128
Fax Number: +5281 8124 0129
Address: Miravalle Center, piso PB, Suite 106
Calz San Pedro 250 Nte. Monterrey,
Nuevo Leon Mexico

EMEA Region

Grove RT

Telephone number: + 44 191 565 6281
Fax number: + 44 191 515 7475
Address: Akeler House, 1 Emperor Way
Doxford International Business park
Sunderland, England SR3 3XR

Grove GMK

Telephone Number: + 49 4421 294 454
Fax number: + 49 4421 294 244
Address: Industriegelände West
26389 Wilhelmshaven
Postfach 1853, Germany

Potain & Manitowoc

Telephone number: + 33 472 182 164
Fax number: + 33 472 182 109
Address: 18 Chemin de Charbonnières
69130 Ecully, France

Manlift - France

Telephone Number: +33 (0) 553 84 85 86
Fax number: +33 (0) 553 84 85 74
Address: Delta Manlift ZI de Fauillet BP 20
F-47400 Tonneins, France

Manlift - Germany

Telephone Number: + 49 (0) 7253 9401 13
Fax number: + 49 (0) 7253 9401 16
Address: Liftflux Potain GmbH
Service und Ersatzteilzentrum
Heidigstrasse 17 D-76709 Kronau, Germany



www.manitowoccranecare.com

Asia/Pacific Region

China, Peoples Republic of

Manitowoc Crane Group Asia PTE LTD
Telephone Number: + 65 6264 1188
Fax Number: + 65 6862 4040 (Sales/Admin)
+ 65 6862 4142 (Parts/Service)
+65 6264 7596(Service)
Address: 4 Kwong Min Road
Singapore, 628707 PR China

Zhangjiagang

Telephone Number: + 86 512 5878 0088
Fax number: + 86 512 5878 0098
Address: No 55 Zhen Bei East Road
South District Zhangjiagang Economic
Development Zone,
Jiangsu Province 215618 P R China

Manitowoc Crane Group Asia Shanghai Office

Telephone number: + 86 21 6270 0442
Fax number: + 86 21 6270 1436
Address: RM. D-305 Shanghai-
Mira Commercial Centre
No.2633, West Yanan Rd
Shanghai, PR China 200336

Manitowoc Crane Group Asia Shanghai Operations Office

Telephone Number: + 86 21 5111 3579
Fax number: + 86 21 5111 3578
Address: Rm1201, #933 Zhongshanxilo
Hongqiao Silver Tower
Shanghai 200051, P R China

Australia

Manitowoc Crane Group Australia

Manitowoc Crane Group - Melbourne Office
Telephone Number: + 61 03 9336 1300
+ 1300 788 089
Fax number: + 61 03 9336 1322
Address: 2/22 Disney Avenue, East Keilor
VIC 3033 Australia

Manitowoc Crane Group - Sydney Office

Telephone Number: + 61 02 9896 4433
+ 1300 788 089
Fax Number: + 61 2 9896 3122
Address: 142 Magowar
Girraween NSW 2145 Australia

Korea

Manitowoc Crane Group Korea CO LTD
Telephone Number: + 82 2 508 3361
Fax number: + 82 2 508 3365
Address: Room 301 Gugu Building #145-18
Samsung-Dong, Kangnam-Ku
Seoul 135-878 Korea

Philippines

Potain Inc.
Telephone Number: + 63 2 844 9437
Fax number: + 63 2 844 4712
Address: G/F Southwest Centre Building
cor Makiling Street South Super
Highway Palanan, Makati City
Philippines