

MDT 349 L12

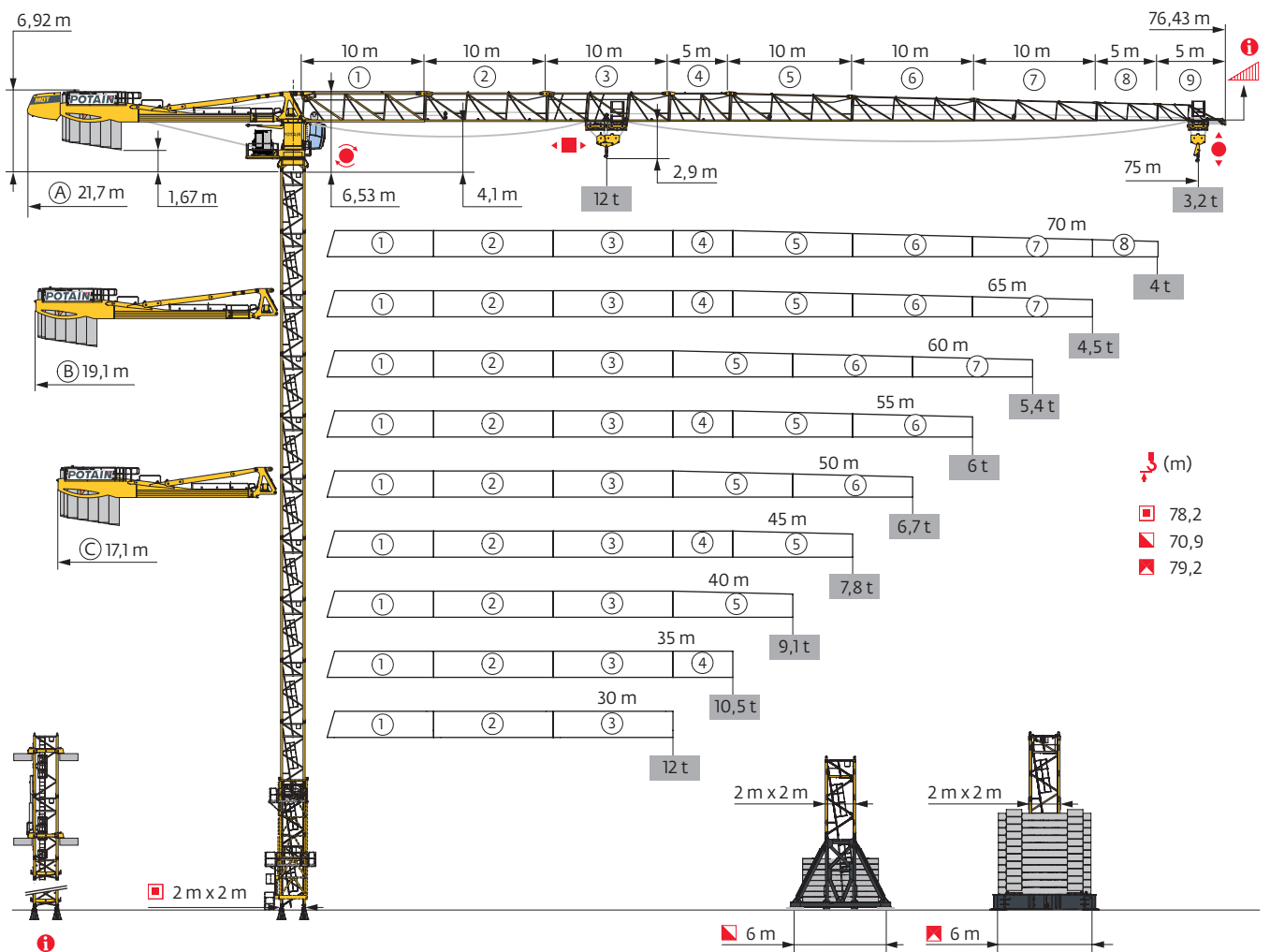

Potain Plus



Power Control

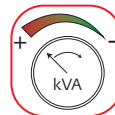

POTAIN®
CONNECT

Top Site

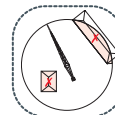



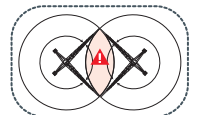

Anti-collision systems



Mât - Réactions / Mast - Reaktionskräfte / Mast - Reactions / Mástil - Reacciones / Torre - Reazioni
 Tramo - Reacções / Реакция опор мачты

2 m - P 63A											
AVAN (m)	30	35	40	45	50	55	60	65	70	75	
↕ (m)	76,6	76,6	74,9	78,2	76,6	78,2	78,2	76,6	76,6	76,6	
↕/P+ (m)	76,6	71,6	71,6	73,2	71,6	74,9	74,9	74,9	74,9	76,6	
	3,33 m	0	0	1	2	0	2	2	0	0	
	5 m	13	13	12	12	13	12	12	13	13	
	10 m	1	1	1	1	1	1	1	1	1	
F2 (t)	●	222	224	220	230	228	230	231	226	234	236
	■	295	299	287	312	304	320	324	316	322	329
F3 (t)	●	159	160	156	163	161	162	163	158	166	168
	■	238	241	229	250	243	258	262	254	260	266

2 m - V 60A - 											
AVAN (m)	30	35	40	45	50	55	60	65	70	75	
↕ (m)	70,9	70,9	70,9	70,9	70,9	70,9	70,9	70,9	70,9	70,9	
↕/P+ (m)	70,9	70,9	69,2	70,9	70,9	70,9	70,9	70,9	70,9	70,9	
	3,33 m	0	0	0	0	0	0	0	0	0	
	5 m	13	13	13	13	13	13	13	13	13	
	F1 (t)	●	116	119	117	115	116	118	118	122	126
	■	139	141	141	138	142	143	145	149	155	160

2 m - V 63A - 											
AVAN (m)	30	35	40	45	50	55	60	65	70	75	
↕ (m)	70,9	70,9	70,9	70,9	70,9	70,9	70,9	70,9	70,9	70,9	
↕/P+ (m)	70,9	70,9	69,2	70,9	70,9	70,9	70,9	70,9	70,9	70,9	
	3,33 m	0	0	0	0	0	0	0	0	0	
	5 m	12	12	12	12	12	12	12	12	12	
	F1 (t)	●	117	119	118	116	120	119	118	122	126
	■	142	144	144	141	145	146	148	152	158	163

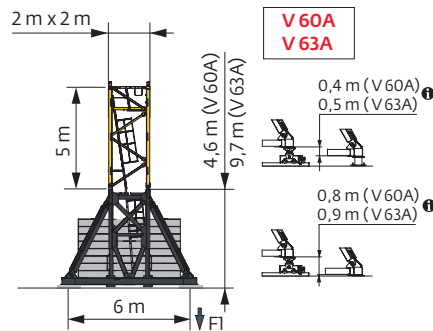
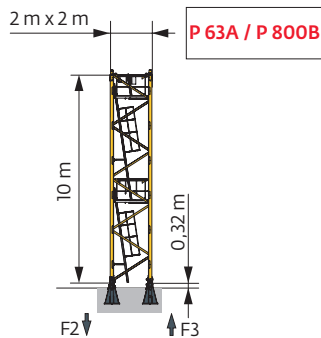

i Autres compositions de pylône - Nous consulter. / Andere Turmaufbauten - bitte kontaktieren Sie uns. / Other mast compositions - Please consult us. / Para otras composiciones de mástil - Por favor contáctenos. / Per altre composizioni torre, contattateci. / Para outras composições de coluna - Por favor, consulte-nos. / Для других композиций мачты пожалуйста проконсультируйтесь с нами.

Accès motorisés : compositions de mâture, de lest de base et réactions adaptées. / Motorisierter Zugang vom : Mastzusammensetzung, Grundballast und Reaktionskräfte sind angepasst. / Motorized accesses: adapted mast composition, base ballast and reactions. / Acceso a cabina con elevador: Adaptación de composición de mástil, lastre de base y reacciones. / Accessi motorizzati: composizioni elementi torre, zavorre di base e reazioni aggiornate. / Acessos motorizados: composições de coluna, lastro da base e reacções adaptadas. / Лифты : адаптированная композиция мачты, базовый балласт и нагрузки.

2 m - ZX 640 -

h (m)	30	35	40	45	50	55	60	65	70	75
\downarrow (m)	77,5	74,2	74,2	77,5	75,9	79,2	77,5	77,5	75,9	75,9
\downarrow/P (m)	77,5	70,9	70,9	72,5	72,5	74,2	75,9	74,2	74,2	75,9
3,33 m	0	2	2	0	1	2	0	0	1	1
5 m	13	11	11	13	12	12	13	13	12	12
10 m	1	1	1	1	1	1	1	1	1	1
Fl (t)	● 134	125	125	134	133	144	139	142	141	144
	■ 171	158	157	170	167	185	178	182	178	183

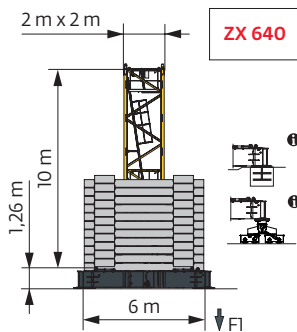

Ancrages / Verankerungen / Anchorages / Anclajes / Ancoraggi
 Ancoragem / нкрепа

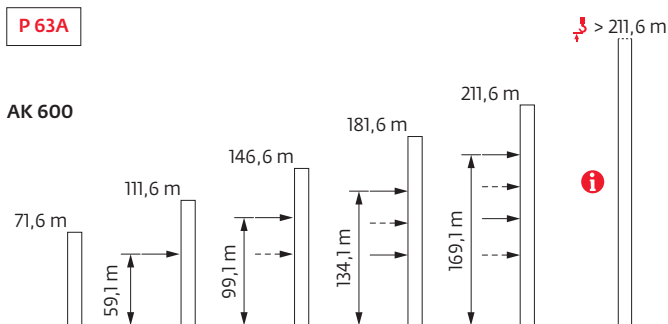

Lest de base / Grundballast / Base ballast / Lastre de base / Zavorra di base
 Lastro da base / Базовый Балласт

⚖️(t) / 📏2 m - V 60A - 🚛

⚖️(t) / 📏2 m (m)	30	35	40	45	50	55	60	65	70	75
70,9	120	120	120	108	108	120	120	120	132	132
65,9	96	96	96	84	96	84	84	96	96	108
60,9	84	96	96	84	84	84	84	72	72	72
55,9	72	84	84	72	72	72	60	60	60	72
50,9	60	72	72	60	60	60	60	60	60	60
45,9	60	60	60	48	60	48	48	48	60	60
40,9	60	60	60	48	48	48	48	48	48	60
35,9	60	60	60	48	48	48	48	48	48	60
30,9	60	60	60	48	48	48	48	48	48	60
25,9	60	60	60	48	48	48	48	48	48	60
20,9	60	60	60	48	48	48	48	48	48	60

⚖️(t) / 📏2 m - V 63A - 🚛



⚖️(t) / 📏2 m (m)	30	35	40	45	50	55	60	65	70	75
70,9	120	120	120	108	120	120	120	120	132	144
65,9	96	96	96	96	96	84	96	96	108	108
60,9	84	96	96	84	84	84	72	72	72	84
55,9	72	84	84	72	72	72	60	60	60	72
50,9	60	72	72	60	60	60	48	60	60	60
45,9	60	60	60	48	60	48	48	48	60	60
40,9	48	60	60	48	48	48	48	48	60	60
35,9	48	60	60	48	48	48	36	48	48	60
30,9	48	60	60	48	48	48	36	48	48	60
25,9	48	60	60	48	48	48	36	36	48	60
20,9	48	60	60	48	48	48	36	36	48	60

⚖️(t) / 📏2 m - ZX 640 - 🚛











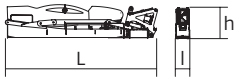

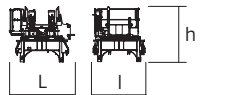

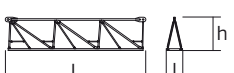

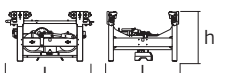
⚖️(t) / 📏2 m (m)	30	35	40	45	50	55	60	65	70	75
79,2	180									
77,5	160			150		160	170	180		
75,9	140			140	150	150	150	160	170	180
74,2	130	130	130	130	130	140	140	150	160	160
69,2	100	110	110	100	100	100	110	110	120	130
64,2	100	100	100	90	90	90	90	80	90	90
59,2	90	90	90	90	90	80	80	80	70	70
54,2	80	90	90	80	80	70	70	60	60	60
49,2	60	80	80	60	70	60	60	50	50	50
44,2	60	70	70	50	60	50	50	40	50	50
39,2	50	60	60	50	50	40	40	40	40	50
34,2	50	60	60	50	50	40	40	40	40	50
29,2	50	60	60	50	50	40	40	40	40	50
24,2	50	60	60	50	50	40	40	40	40	50
19,2	50	60	60	50	50	40	40	40	40	50



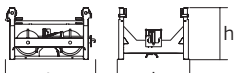

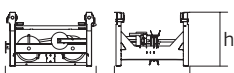

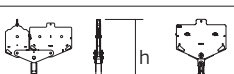

Encombremet et poids / Abmessungen und Gewicht / Dimensions and weight / Dimensiones y peso / Ingombro e peso
 dimensões e pesos / габаритные размеры и вес

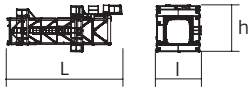
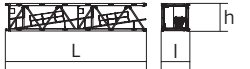
Partie tournante / Drehender Kranteil / Slewing crane part / Parte giratoria

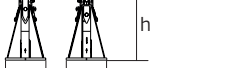
Parte rotante / Parte rotativa / Поворотная часть :  75 m -  75/90 HPL™

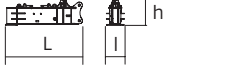

Partie tournante / Drehender Kranteil / Slewing crane part Parte giratoria / Parte rotante / Parte rotativa Поворотная часть		L (m)	l (m)	h (m)	kg (+/- 5%)	
Contre-flèche / Gegenausleger Counter-jib / Contra-flecha Controbraccio / Contra-lança Контр-стрела		Ⓐ 12 Ⓑ 12 Ⓒ 12	1,25 1,25 1,25	2,5 2,5 2,5	14110 13600 11540	
Mât-cabine + cabine / Kabinenmast + Kabine Cab mast + cab / Mástil-cabina + cabina Portaralla superiore + cabina / Tramo-cabina + cabina Секция мачты кабины + кабина		Ultra View	5,03	2,22	2,49	6720
Pivot / Krankopf Towerhead / Pivote Portaralla / Pivot Секция поворотной части		⌈ 2 m	2,95	2,48	2,5	7620
Treuil de levage (+ câble) / Hubwerk (+ Seil) Hoisting winch (+ rope) / Mecanismo de elevación (+ cabo) Argano di sollevamento (+ fune) Guincho de elevação (+ cabo) Подъемная лебедка (+ канатом)		75/90 HPL™	4,27	2,3	2,32	4500
Elément de flèche / Auslegerement Jib section / Elemento de flecha Elemento di braccio / Elemento de lança Секция стрелы		① 6 DVF	10,75	1,8	2,74	5450
Elément de flèche / Auslegerement Jib section / Elemento de flecha Elemento di braccio / Elemento de lança Секция стрелы		② ③ ⑤ ⑥ ⑦	10,21 10,31 10,22 10,24 10,19	1,2 1,2 1,2 1,2 1,2	2,5 2,42 2,39 2,1 1,83	3145 2420 1560 1235 950
Elément de flèche / Auslegerement Jib section / Elemento de flecha Elemento di braccio / Elemento de lança Секция стрелы		④ ⑧ ⑨	5,27 5,09 5,09	1,2 1,2 1,2	2,39 1,53 1,39	960 310 220
Chariot / Laufkatze Trolley / Carrello Carro / Carro-distribuidor Тележка		 12 t	1,87	1,51	1,05	400
Moufle / Hubflasche Pulley block / Aparejo Bozzello / Cadernal Полиспаст		 12 t	1,19	0,43	2,31	455
Chariot / Laufkatze Trolley / Carrello Carro / Carro-distribuidor Тележка		 12 t	1,57	1,51	0,98	210
Chariot / Laufkatze Trolley / Carrello Carro / Carro-distribuidor тележка		 12 t  6 t	1,7 1,86	1,51 1,51	1,03 0,98	245 236
Moufle / Hubflasche Pulley block / Aparejo Bozzello / Cadernal Полиспаст		 12 t  6 t	1,65 1,09	0,22 0,27	1,78 1,62	450 265

Рулоне / Kranturm / Crane tower Mástil / Torre / Torre Башня крана		L (m)	l (m)	h (m)	kg (+/- 5%)
T 61		10,83	4,14	4,47	9700
K 649B KM 649E KRM 6410B		10,23 10,29 10,23	2,07 2,03 2,1	2,03 2,03 2,08	5290 4850 7100
K 649A KMT 649A KR 649A KRMT 649A		5,23 5,23 5,23 5,23	2,07 2,07 2,1 2,1	2,03 2,03 2,08 2,08	2805 2570 3250 3050
K 649C KMT 649C KRMT 649C		3,57 3,57 3,57	2,07 2,07 2,1	2,03 2,03 2,08	2070 2060 2450
Pieds de scellement / Verankerungsfüße Fixing angles / Pie de empotramiento Montante da anegare / Angulos fixadores анкера			0,75	1,28	465
Mât-châssis / Grundmasteinheit Basic mast unit / Tramo-chasis Elemento base / Tramo-chassis Мачта для крепления к шасси		5,01 10,02	2,41 2,41	2,41 2,41	4760 7660
Haubans / Mastabstützungen / Struts / Tornapuntas Puntoni / Escoras / Растяжка		4,51 4,51	0,29 0,33	0,29 0,33	470 560
Sommier / Unterwagenhälfte Half-bearer / Testero Testata / Estrutura base Траверса		6,7 6,7	0,7 0,7	2,31 2,31	1840 1860
1/2 Bras de croix / 1/2 Fundamentkreuzträger 1/2 Cross girder / 1/2 Braço en cruz 1/2 Braccio croce / 1/2 Braço da cruz 1/2 Поперечная балка		4,35	1	1,56	3320
Bras de croix / Fundamentkreuzträger Cross girder / Braço en cruz Braccio croce / Braço da cruz Поперечная балка		9,15	1,19	1,56	6880

Mécanismes / Triebwerke / Mechanisms / Mecanismos / Meccanismi
 Механизмы / Механизмы

400 V - 50 Hz 480 V - 60 Hz													ch - PS hp	kW		
	400 V - 50 Hz	75 HPL™ 30	m/min	44	57,5	82	140	220,5	23	30	43,5	74	110	75	55	845 m
			t	6	4,5	3	1,5	0,2	12	9	6	3	0,8			
	480 V - 60 Hz	90 HPL™ 30	m/min	53,5	69,5	99,5	143	220,5	27,5	36,5	52,5	74,5	110	90	66	
			t	6	4,5	3	1,5	0,2	12	9	6	3	0,8			
		6 DVF 6 Optima	m/min	0 → 42 (12 t) 0 → 84 (8 t) 0 → 100 (4 t)									5,5	4		
	400 V - 50 Hz 480 V - 60 Hz	RVF 172 Optima+	tr/min U/min rpm	400 V - 50 Hz : 0 → 0,8 480 V - 60 Hz : 0 → 0,9									2 x 10	2 x 7,5		

IEC 60204-32	kVA
400 V (+10% -10%) 50 Hz	75 HPL™ : 84 → 54 kVA
480 V (+6% -10%) 60 Hz	90 HPL™ : 96 → 60 kVA

	FR	DE	EN	ES	IT	PT	RU
	Appel de flèche	Auslegerüberhöhung	Jib elevation	Elevación de la flecha	Inclinazione braccio	Desvio da lança	подъем стрелы
	Équipements standards	Standardausrüstungen	Standard equipment	Equipamiento de serie	Equipaggiamento standard	Equipamento de série	Стандартное оборудование
	Équipements optionnels	Sonderausrüstungen	Options	Equipamiento opcional	Equipaggiamento in opzione	Equipamento opcional	Дополнительное оборудование (опция)
	Fonction Potain Plus : Courbes de charges Plus	Funktion Potain Plus: Plus-Lastkurven	Potain Plus function: Plus load curves	Función Potain Plus: Diagrama de cargas Plus	Funzione Potain Plus: Curve di carico Plus	Função Potain Plus: Diagrama de cargas Plus	Функция контроля мощности Potain Plus: Диаграммы грузоподъемности Plus
	Hauteurs sous crochet associées aux courbes de charges Plus	Hakenhöhen mit Plus-Lastkurven	Hook heights with Plus load curves	Altura bajo gancho, usando el diagrama de cargas Plus	Altezze sotto gancio con curve di carico Plus	Altura livre, utilizando o diagrama de cargas Plus	Высота под крюком для диаграмм грузоподъемности Plus
	Réactions en service	Reaktionskräfte in Betrieb	Reactions in service	Reacciones en servicio	Reazioni in servizio	Reacções em serviço	Реакция при работе
	Réactions hors service	Reaktionskräfte außer Betrieb	Reactions out of service	Reacciones fuera de servicio	Reazioni fuori servizio	Reacções fora de serviço	Реакция в покое
	Poids total du lest	Ballast-Gesamtgewicht	Total ballast weight	Peso total del lastre	Peso totale della zavorra	Peso total do lastro	Общий вес балласта
	Cadre d'ancrage serré	Fester Verankerungsrahmen	Tightened anchorage frame	Marco de anclaje de apriete	Quadro di ancoraggio stretto	Quadro de amarração apertado	Прикрепленная анкерная рама
	Cadre d'ancrage desserré	Loser Verankerungsrahmen	Loosened anchorage frame	Marco de anclaje de desapriete	Quadro di ancoraggio allentato	Quadro de amarração solto	Отсоединенная анкерная рама
	Poids de flèche	Auslegergewicht	Jib weight	Peso de flecha	Peso del braccio	Peso da lança	вес стрелы
	Camion 13,4 m	Lkw 13,4 m	Lorry 13,4 m	Camión 13,4 m	Camion 13,4 m	Camião 13,4 m	Ррузовой автомобиль 13,4 м
	Conteneur High Cube 40', et/ou Flat Rack 20'	Container High Cube 40', und/oder Flat Rack 20'	Container High Cube 40', and/or Flat Rack 20'	Contenedor High Cube 40', y/o Flat Rack 20'	Container High Cube 40', e/o Flat Rack 20'	Contentor High Cube 40', e/ou Flat Rack 20'	40-футовый контейнер повышенной вместимости High Cube, и/или 20-футовая открытая платформа Flat Rack
	Levage	Heben	Hoisting	Elevación	Sollevarmento	Elevação	Подъем
	Distribution	Katzfahren	Trolleying	Distribución	Ditribuzione	Distribuição	Перемещение по стреле
	Orientation	Schwenken	Slewing	Orientación	Rotazione	Rotação	Поворот
	Translation	Kranfahren	Travelling	Traslación	Traslazione	Translação	Перемещение крана
	Puissance requise	Erforderliche Leistung	Required power	Potencia Necesaria	Potenza richiesta	Potência Necessária	Потребляемая мощность
	Fonction Power Control : vitesses treuils adaptées à la puissance disponible	Funktion Power Control: Geschwindigkeiten der Triebwerke werden an die verfügbare Leistung angepasst	Power Control Function: winch speeds adapted to the available power	Función Power Control: marchas de los cabrestantes adaptadas a la potencia disponible	Funzione Power Control: velocità degli argani adattate alla potenza disponibile	Função Power Control: velocidades de guincho adaptadas à potência disponível	Функция контроля мощности Power Control: регулировка скорости лебедок в зависимости от доступной мощности
	Nous consulter	Auf Anfrage	Consult us	Consultarnos	Consultateci	Consultar-nos	Проконсультируйтесь у нас
	Document commercial non contractuel. Pour toute information technique se référer à la notice correspondante.	Unverbindliches Vertriebsdokument. Für technische Informationen, siehe die entsprechenden Anweisungen.	This commercial document is not legally binding. For any technical information, please refer to the corresponding instructions.	Documento comercial no contractual. Para cualquier información técnica, ver la noticia correspondiente.	Documento commerciale non vincolante, per tutte le informazioni tecniche fare riferimento al catalogo istruzioni.	Documento comercial não contratual. Para qualquer informação técnica complementar consultar as respectivas instruções.	Этот коммерческий документ не является юридически обязательным. Для получения технической информации, см. соответствующие инструкции.

