

## MDT 259 J10

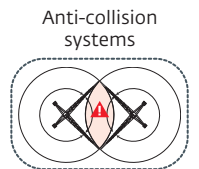
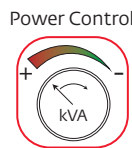
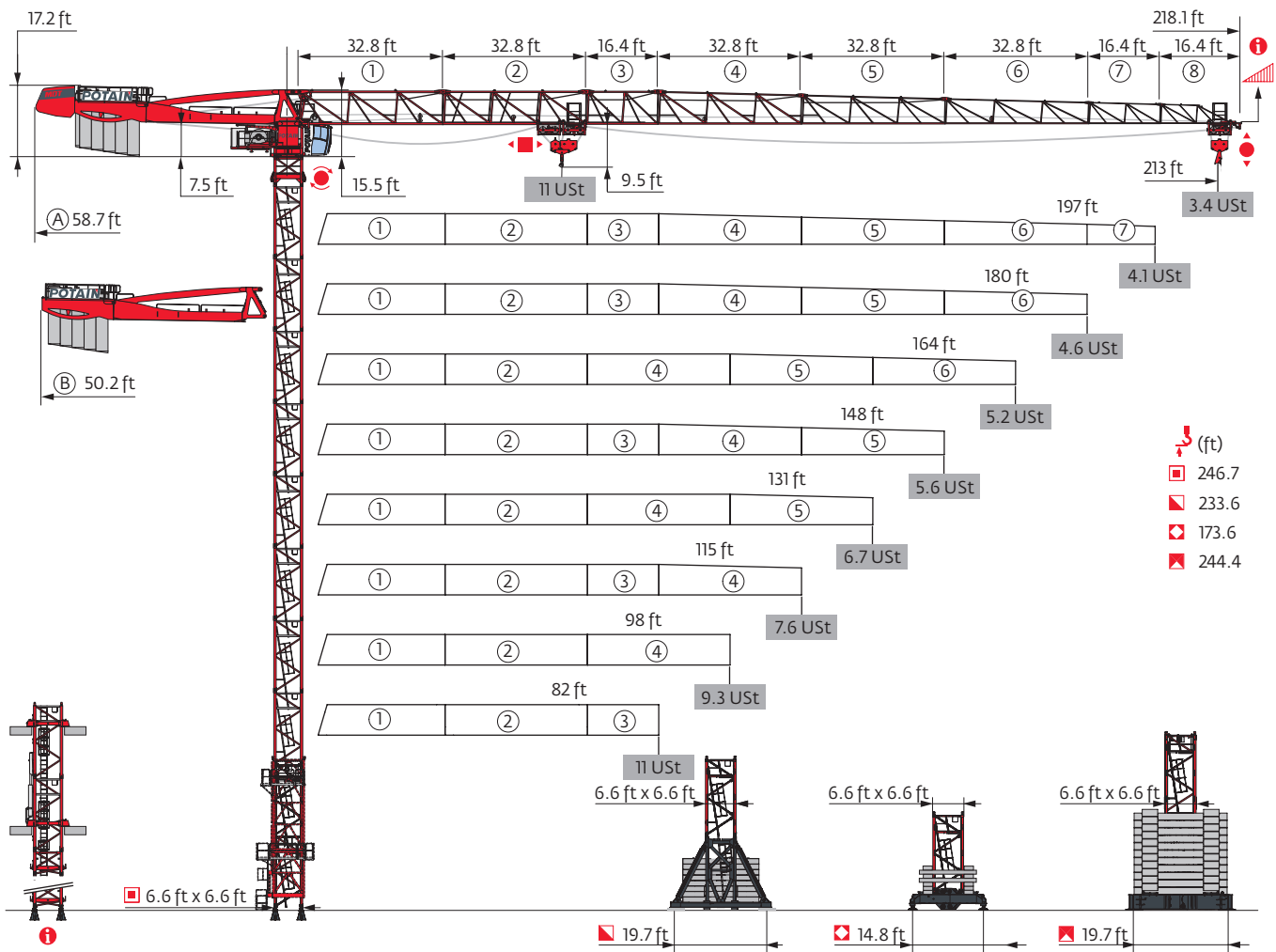

Mast - Reactions

**6.6 ft - P 63A**

Height (ft)	82	98	115	131	148	164	180	197	213
$H$ (ft)	246.7	241.1	241.1	235.6	235.6	235.6	235.6	224.7	224.7
$H/P_+$ (ft)	246.7	241.1	241.1	235.6	235.6	235.6	235.6	224.7	224.7
6.6 ft	1	1	1	1	1	1	1	1	1
10.9 ft	1	2	2	0	0	0	0	2	2
16.4 ft	12	11	11	12	12	12	12	10	10
32.8 ft	1	1	1	1	1	1	1	1	1
F2 (USt)	● 212 ■ 385	209 371	213 377	208 356	209 364	209 365	209 363	206 332	207 338
F3 (USt)	● 159 ■ 338	155 323	158 328	153 307	153 313	153 315	150 310	147 278	148 285

**6.6 ft - V 60A - V 63A**

Height (ft)	82	98	115	131	148	164	180	197	213
$H$ (ft)	206	211.3	206	211.3	211.3	211.3	211.3	211.3	211.3
$H/P_+$ (ft)	206	211.3	206	211.3	211.3	211.3	211.3	211.3	211.3
6.6 ft	1	1	1	1	1	1	1	1	1
10.9 ft	2	1	2	1	1	1	1	1	1
16.4 ft	10	11	10	11	11	11	11	11	11
F1 (USt)	● 110 ■ 145	112 151	112 147	114 152	114 156	114 157	117 155	118 154	118 158

**6.6 ft - V 63A - V 63A**

Height (ft)	82	98	115	131	148	164	180	197	213
$H$ (ft)	228	233.6	233.6	233.6	233.6	233.6	233.6	228	228
$H/P_+$ (ft)	228	233.6	233.6	233.6	233.6	233.6	233.6	228	228
6.6 ft	1	1	1	1	1	1	1	1	1
10.9 ft	1	0	0	0	0	0	0	1	1
16.4 ft	11	12	12	12	12	12	12	11	11
F1 (USt)	● 131 ■ 181	133 188	134 190	134 188	135 192	135 193	138 191	134 182	134 186

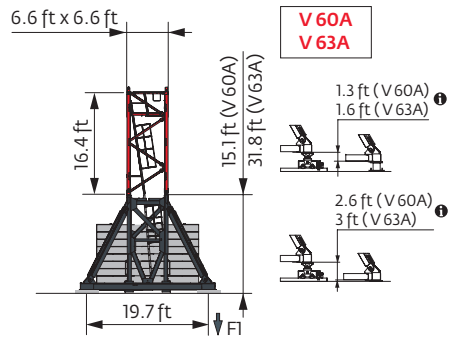
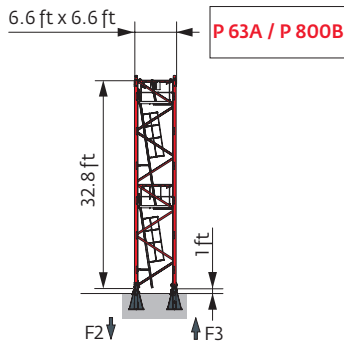

**6.6 ft - ZD 463 -**

AVAIL (ft)	82	98	115	131	148	164	180	197	213
(ft)	168	173.6	168	168	168	168	168	162.7	162.7
/P+ (ft)	168	173.6	168	168	168	168	162.7	162.7	162.7
	6.6 ft	1	1	1	1	1	1	1	1
	10.9 ft	1	0	1	1	1	1	2	2
	16.4 ft	9	10	9	9	9	9	8	8
FI (USt)	● 111	114	113	111	110	112	116	115	115
	■ 130	138	133	129	134	135	133	124	129

**6.6 ft - ZX 640 -**

AVAIL (ft)	82	98	115	131	148	164	180	197	213
(ft)	244.4	244.4	244.4	238.9	238.9	238.9	238.9	228	228
/P+ (ft)	244.4	244.4	244.4	238.9	238.9	238.9	238.9	228	228
	6.6 ft	1	1	1	1	1	1	1	1
	10.9 ft	2	2	2	0	0	0	2	2
	16.4 ft	11	11	11	12	12	12	10	10
	32.8 ft	1	1	1	1	1	1	1	1
FI (USt)	● 142	143	145	138	141	141	139	130	133
	■ 199	199	202	190	195	196	193	174	179

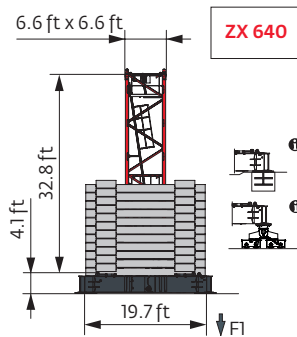
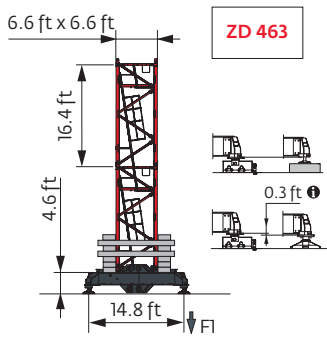

Note: When "ASCE" is noted in this data sheet it is referring to 115 mph Wind Zone, Exposure B, Design Wind Speed = 98 mph. See back cover for design wind speed calculations.

Motorized accesses: adapted mast compositions, base ballast and reactions.

Other mast compositions - Please consult us

Anchorage

Base ballast

**Ust) / 6.6 ft - V 60A -**

Δ (ft)	82	98	115	131	148	164	180	197	213
211.3	145.5		145.5	145.5	145.5	145.5	145.5	145.5	145.5
206	145.5	145.5	145.5	132.3	145.5	145.5	132.3	132.3	132.3
189.6	105.8	105.8	105.8	105.8	105.8	105.8	105.8	105.8	105.8
173.2	79.4	79.4	79.4	79.4	79.4	79.4	92.6	92.6	92.6
156.8	66.1	66.1	66.1	66.1	66.1	66.1	66.1	66.1	66.1
140.4	52.9	52.9	52.9	52.9	52.9	52.9	52.9	52.9	52.9
124	39.7	39.7	39.7	39.7	39.7	39.7	39.7	39.7	39.7
107.6	39.7	39.7	39.7	39.7	39.7	26.5	26.5	26.5	26.5
91.2	39.7	39.7	39.7	39.7	39.7	26.5	26.5	26.5	26.5
74.8	39.7	39.7	39.7	39.7	39.7	26.5	26.5	26.5	26.5

**Ust) / 6.6 ft - V 63A -**

Δ (ft)	82	98	115	131	148	164	180	197	213
233.6	198.4		198.4	198.4	198.4	198.4	198.4	198.4	198.4
228	198.4	185.2	185.2	185.2	185.2	185.2	185.2	185.2	185.2
211.6	158.7	158.7	158.7	145.5	158.7	158.7	145.5	145.5	145.5
195.2	132.3	119.1	119.1	119.1	119.1	119.1	119.1	105.8	119.1
178.8	92.6	92.6	92.6	92.6	92.6	92.6	92.6	92.6	92.6
162.4	79.4	79.4	79.4	66.1	66.1	66.1	79.4	79.4	79.4
146	66.1	66.1	66.1	52.9	52.9	52.9	66.1	66.1	66.1
129.6	52.9	52.9	52.9	39.7	39.7	39.7	52.9	52.9	52.9
113.2	39.7	39.7	39.7	39.7	26.5	26.5	39.7	39.7	26.5
96.8	26.5	39.7	26.5	39.7	26.5	26.5	26.5	26.5	26.5
80.4	26.5	39.7	26.5	39.7	26.5	26.5	26.5	26.5	26.5

**Ust) / 6.6 ft - ZD 463 -**

Δ (ft)	82	98	115	131	148	164	180	197	213
173.6	137.8								
168	132.3	126.8	132.3	126.8	121.3	126.8	137.8		
162.7	126.8	121.3	121.3	121.3	115.7	115.7	132.3	132.3	132.3
146.3	104.7	99.2	104.7	99.2	93.7	93.7	110.2	110.2	110.2
129.9	88.2	82.7	82.7	82.7	77.2	77.2	88.2	88.2	88.2
113.5	71.7	77.2	71.7	77.2	71.7	66.1	66.1	71.7	66.1
97.1	71.7	77.2	71.7	77.2	71.7	66.1	60.6	49.6	55.1
80.7	71.7	77.2	71.7	77.2	71.7	66.1	60.6	49.6	55.1
64.3	71.7	77.2	71.7	77.2	71.7	66.1	60.6	49.6	55.1

**Ust) / 6.6 ft - ZX 640 -**

Δ (ft)	82	98	115	131	148	164	180	197	213
244.4	220.5	220.5	220.5						
238.9	198.4	198.4	198.4	198.4	209.4	209.4	198.4		
228	176.4	176.4	176.4	176.4	176.4	176.4	176.4	165.4	176.4
211.6	143.3	143.3	143.3	132.3	143.3	143.3	132.3	143.3	143.3
195.2	110.2	110.2	110.2	110.2	110.2	110.2	110.2	121.3	121.3
178.8	99.2	88.2	99.2	99.2	88.2	88.2	88.2	99.2	99.2
162.4	77.2	77.2	77.2	77.2	77.2	77.2	77.2	88.2	77.2
146	66.1	66.1	66.1	66.1	55.1	55.1	55.1	66.1	66.1
129.6	44.1	44.1	44.1	44.1	44.1	44.1	44.1	44.1	44.1
113.2	33.1	33.1	33.1	33.1	33.1	33.1	22.1	33.1	33.1
96.8 ↓	33.1	33.1	33.1	33.1	33.1	33.1	22.1	22.1	22.1
64	33.1	33.1	33.1	33.1	33.1	33.1	22.1	22.1	22.1

Load curves



		(ft)																				ft
		11 USt										5.5 USt										
213	10 → 69	123 - 133	11	10.4	9	8.2	7.2	6.7	6	5.6	5.5	5.3	4.9	4.6	4.3	4.1	3.9	3.7	3.5	3.3	3.2	USt
	10 → 75	133 - 144	11	11	9.9	9	8	7.4	6.6	6.2	5.6	5.5	5.3	5.1	4.7	4.5	4.2	4	3.8	3.6	3.4	USt P+
197	10 → 73	130 - 141	11	11	9.6	8.8	7.7	7.2	6.4	6	5.5	5.5	5.2	5	4.6	4.4	4.1	4	3.7			USt
	10 → 79	141 - 152	11	11	10.6	9.7	8.5	7.9	7.1	6.6	6	5.7	5.5	5.4	5.1	4.8	4.5	4.3	4.1			USt P+
180	10 → 74	134 - 144	11	11	9.8	9	8	7.4	6.6	6.2	5.6	5.5	5.3	5.1	4.7	4.5	4.2					USt
	10 → 81	145 - 155	11	11	10.5	9.9	8.8	8.1	7.3	6.8	6.2	5.9	5.5	5.5	5.2	4.9	4.6					USt P+
164	10 → 74	134 - 144	11	11	9.9	9	8	7.4	6.7	6.2	5.7	5.5	5.4	5.1	4.7							USt
	10 → 81	145 - 156	11	11	10.9	9.9	8.8	8.2	7.3	6.9	6.2	5.9	5.5	5.5	5.2							USt P+
148	10 → 76	137 - 148	11	11	10.1	9.2	8.2	7.6	6.8	6.4	5.8	5.5	5.5									USt
	10 → 82		11	11	11	10.2	9	8.3	7.5	7	6.4	6	5.5									USt P+
131	10 → 79		11	11	10.5	9.6	8.5	7.9	7.1	6.7	6.1											USt
	10 → 85		11	11	11	10.6	9.4	8.7	7.8	7.3	6.7											
115	10 → 76		11	11	10.1	9.2	8.2	7.6	6.8													USt
	10 → 82		11	11	11	10.2	9	8.3	7.5													USt P+
98	10 → 78		11	11	10.3	9.5	8.4															USt
	10 → 84		11	11	11	10.4	9.2															USt P+
82	10 → 78		11	11	10.4																	USt
	10 → 82		11	11	10.9																	USt P+

$W = W - 0.53 \text{ USt max.}$



		(ft)																				ft
		11 USt										5.5 USt										
213	8 → 69	124 - 127	11	10.5	9.1	8.3	7.3	6.8	6.1	5.7	5.3	5	4.6	4.3	4	3.8	3.5	3.4	3.2	3	2.85	USt
	8 → 75	134 - 137	11	11	10	9.1	8	7.4	6.7	6.2	5.7	5.3	5	4.8	4.4	4.2	3.9	3.7	3.5	3.3	3.1	USt P+
197	8 → 73	132 - 135	11	11	9.7	8.8	7.8	7.2	6.5	6.1	5.5	5.3	4.9	4.7	4.3	4.1	3.8	3.6	3.4			USt
	8 → 79	142 - 145	11	11	10.6	9.7	8.6	8	7.2	6.7	6.1	5.7	5.3	5.1	4.7	4.5	4.2	4	3.8			USt P+
180	8 → 75	135 - 138	11	11	9.9	9.1	8	7.5	6.7	6.3	5.7	5.5	5.1	4.8	4.5	4.3	4					USt
	8 → 81	146 - 149	11	11	10.6	10	8.8	8.2	7.4	6.9	6.3	5.9	5.5	5.2	4.9	4.7	4.4					USt P+
164	8 → 75	136 - 138	11	11	9.9	9.1	8.1	7.5	6.7	6.3	5.7	5.5	5.1	4.8	4.5							USt
	8 → 81	147 - 150	11	11	10.9	10	8.9	8.2	7.4	6.9	6.3	6	5.5	5.2	4.9							USt P+
148	8 → 76	139 - 141	11	11	10.2	9.3	8.3	7.7	6.9	6.5	5.9	5.5	5.2									USt
	8 → 83		11	11	11	10.3	9.1	8.4	7.6	7.1	6.5	6.1	5.6									USt P+
131	8 → 79		11	11	10.6	9.7	8.6	8	7.2	6.7	6.1											USt
	8 → 86		11	11	11	10.7	9.5	8.8	7.9	7.4	6.7											
115	8 → 76		11	11	10.2	9.3	8.2	7.6	6.9													USt
	8 → 83		11	11	11	10.2	9.1	8.4	7.6													USt P+
98	8 → 78		11	11	10.4	9.5	8.5															USt
	8 → 85		11	11	11	10.5	9.3															USt P+
82	8 → 79		11	11	10.5																	USt
	8 → 82		11	11	11																	USt P+

$W = W - 0.15 \text{ USt max.}$

Jib weight & counter-jib ballast



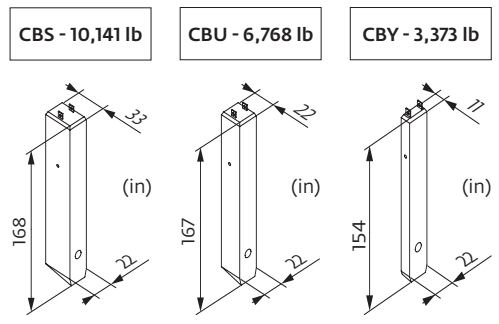

ft	W (lb) (+/- 5%)			CBS-10,141 lb		CBU-6,768 lb		CBY-3,373 lb	
	W	U	U	10,141 lb	3,373 lb	6,768 lb	3,373 lb	3,373 lb	3,373 lb
213 ft	27,472	26,863	27,672	5	1	54,079	7	2	54,123
197 ft	26,978	26,369	27,179	5	1	54,079	7	2	54,123
180 ft	26,131	25,589	26,288	5	0	50,706	7	1	50,750
164 ft	24,273	23,731	24,429	4	1	43,938	6	1	43,982
148 ft	24,588	24,046	24,745	4	1	43,938	6	1	43,982
131 ft	22,800	22,258	22,957	4	0	40,565	6	0	40,609
115 ft	22,536	21,993	22,692	3	2	37,170	5	1	37,214
98 ft	20,435	19,892	20,591	3	1	33,797	5	0	33,841
82 ft	19,268	18,726	19,425	3	0	30,424	4	1	30,446





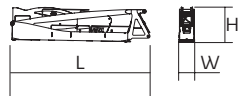

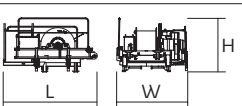
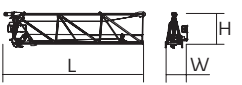
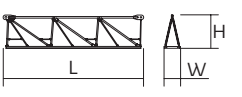
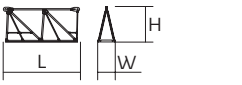
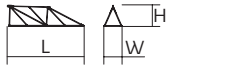

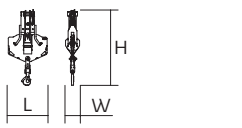
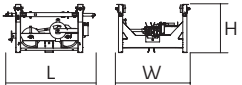
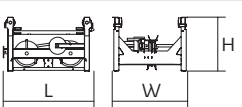
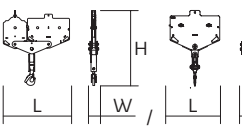

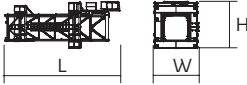

Dimensions and weight

Slewing crane part:  213 ft -  50 LVF

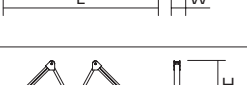
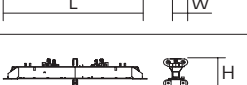
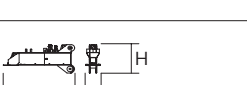

Slewing crane part		L (ft)	W (ft)	H (ft)	lb (+/- 5%)
Counter-jib		36.1 36.1	3.8 3.8	8.1 8.1	19,213 18,629
Towerhead + cab		16.1	7.5	8.3	18,618
Hoisting winch (+ rope)		10.6 10.6	8.1 10.8	6.2 5.8	7,319 9,092
Jib section		35.5	5.6	9	7,959
Jib section		33.8 33.5 33.6 33.4	3.9 3.9 3.9 3.9	7.9 7.8 6.9 6	5,335 3,439 2,723 1,753
Jib section		17.3 16.7	3.9 3.9	7.8 5	2,116 683
Jib section		16.7	3.9	4.6	485
Trolley		6.1	5	3.4	882
Pulley block		3.3	1.4	6.6	694
Trolley		5.2	5	3.2	463
Trolley		5.6 6.1	5 5	3.4 3.2	540 520
Pulley block		5.4 3.6	0.7 0.5	5.6 4.9	717 430

Crane tower		L (ft)	W (ft)	H (ft)	lb (+/- 5%)	
Telescopic cage T 61		6.6 ft	35.5	13.6	14.7	21,385
K60/K60-2		6.6 ft	7.3	8.2	8.1	4,255
K 649B KM 649E KRM 6410B		6.6 ft	33.6 33.8 33.6	6.8 6.7 6.9	6.7 6.7 6.8	11,663 10,692 15,653
K 649A KMT 649A KR 649A KRMT 649A		6.6 ft	17.2 17.2 17.2 17.2	6.8 6.8 6.9 6.9	6.7 6.7 6.8 6.8	6,184 5,666 7,165 6,724
K 649C KMT 649C KRMT 649C		6.6 ft	11.7 11.7 11.7	6.8 6.8 6.9	6.7 6.7 6.8	4,559 4,542 5,401
Fixing angles		P 63A / P 800B	2.5	2.5	4.2	1,025
Basic mast unit		V 60A V 63A	16.4 32.9	7.9 7.9	7.9 7.9	10,494 16,887
Struts		V 60A V 63A	14.8 14.8	1 1.1	1 1.1	1,036 1,235
Half-bearer		V 60A V 63A	22 22	2.3 2.3	7.6 7.6	4,057 4,101
Cross girder		ZD 463	25.1	3.8	4.5	7,904
1/2 Cross girder		ZD 463	11.2	2.3	4.4	3,649
1/2 Cross girder		ZX 640	14.3	3.3	5.1	7,319
Cross girder		ZX 640	30	3.9	5.1	15,168

Mechanisms

480 V - 60 Hz											hp	kW			
	50 LVF 25 Optima	fpm	126	166	221	313	66	85	115	157	50	37	1,827 ft		
		USt	5.5	4.1	2.8	1.1	11	8.3	5.5	2.5					
	90 HPL™ 25	fpm	213	279	392	518	707	110	146	203	271	353	90	66	2,736 ft
		USt	5.5	4.1	2.8	1.4	0.4	11	8.3	5.5	2.8	1.3			
	6 DVF 4 Optima	fpm	0 → 164 (11 USt) 0 → 328 (6.6 USt) 0 → 394 (3.3 USt)									5.5	4		
	RVF 162 Optima+	rpm	0 → 0.9									2 x 7.5	2 x 5.5		

480 V (+6% -10%) 60 Hz	50 LVF: 58 → 38 kVA	
	90 HPL™: 90 → 54 kVA	

50 LVF 25 Optima

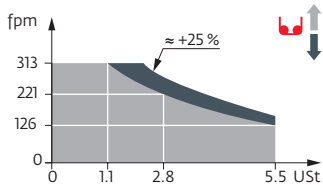

These mast combinations meet the EN 14439 and ASME B30.3-2016 specifications for "out of service" wind conditions, provided the illustrated wind speed matches required design wind speed for the location of the tower crane. The "out of service" design wind speed was determined in accordance with ASCE 7-10, Figure 26.5-1A. The wind velocity, used for this configuration was 98 mph (158 kph), which represents a nominal design 3-second wind gust at 33 ft (10 m) above ground for Exposure B category. A factor of 0.85 was applied to the 700-year ultimate design wind speed of 115 mph (185 kph), per ASCE 37-02, with the assumption that this crane is considered a temporary structure used during a construction period of 2 years or less.

- Jib elevation
- Standard equipment
- Options
- Potain Plus function: Plus load curves
- Hook heights with Plus load curves
- Reactions in service
- Reactions out of service
- Total ballast weight
- Jib weight
- Lorry 44 ft
- Container High Cube 40 ft, and/or Flat Rack 20 ft
- Hoisting
- Trolleying
- Slewing
- Travelling
- Required power
- Power Control Function: winch speeds adapted to the available power
- Consult us

This commercial document is not legally binding. For any technical information, please refer to the corresponding instructions.

