

RT9130E-2 Product Guide

ANSI B30.5
Imperial 85%



Features

- 120 t (130 USt) capacity
- 12,8 m - 48,8 m (42 ft - 160 ft) five-section, full power boom
- 11 m -18 m (36 ft - 59 ft) offsettable bi-fold swingaway extension
- 8 m (26 ft) extension inserts
- Grove MEGAFORM™ boom
- Cummins 239 kW (320 hp) Tier 4F, diesel engine

GROVE RT9130E-2

The RT9130E-2 has an impressive 130 USt capacity and a Full Vision cab to keep the operator comfortable and maximize productivity with the ergonomically-designed controls..

Features

> Boom

The 48,8 m (160 ft) five-section Full Power boom incorporates the “U” shaped MEGAFORM™ design, which eliminates stiffeners, thus reducing weight and increasing capacity.

> Extensions

A 18 m (59 ft) offsettable bi-fold lattice swingaway extension and two 8 m (26 ft) inserts give the RT9130E-2 a maximum tip height of 85 m (279 ft). A hydraulically offsettable bi-fold lattice swingaway is also available, and conveniently offsets from 0° to 40° from the operator's cab.

> Cab

The Full Vision cab on the RT9130E-2 tilts up to 20° providing the operator additional comfort when working at long boom and extension lengths.

> Removable outrigger boxes

Removable front and rear outrigger boxes provide up to 8552 kg (18,854 lb) of weight reduction for easier transport. Includes the removable 18 100 kg (40,000 lb) of counterweight, auxiliary hoist and rope, and can easily self-remove close to 29 000 kg (64,000 lb).

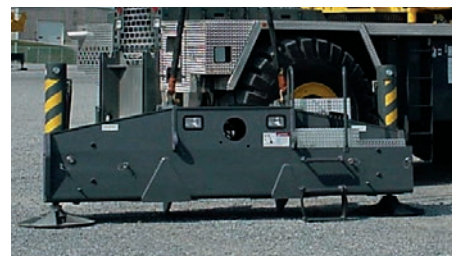

RT9130E-2 benefits

- Competitive capacities and impressive working range ensures maximum utilization and profitability.
- Full power boom allows for telescoping loads if needed. Eliminates excessive time lost pinning and unpinning competitive models pinned boom design.
- Tilt cab, suspension seat, and ergonomically positioned controls supply the operator with a full day comfortable working environment and less fatigue at shift end.
- Counterweight and both outrigger boxes are hydraulically self-removable and installed by the crane.
- Full proportional single axis hydraulic controls provide finger tip control for precise positioning of any load at any boom length or load radius.
- Powerful engine, powershift transmission, 4 wheel drive and 4 wheel steer, and the ability to move with boom extension and inserts installed provides outstanding job-site maneuverability with no time loss.



Manitowoc Finance

Manitowoc Finance gets you in the field with the right equipment by giving you access to flexible, affordable financing. With Maniowoc Finance, equipment can be acquired with virtually no cash outlay, and unlike traditional lending, our financial products don't affect bank lines of credit. Your capital resources remain intact for times when you need ready access to cash.

Competitive rates with flexible financing options and payment schedules put you in control.

Did you know? Maniowoc Finance can finance **used** Maniowoc cranes. You can also **trade-in** your used fleet for upgrade and get financed by Maniowoc Finance.

Contents

- Dimensions 5
- Weights 6
- Working range 7
- Load charts 8
- Working range with inserts 11
- Load charts with inserts 12
- Working ranges - luffing extension 14
- Load charts - luffing extension 16
- Load handling 23
- Specifications..... 24
- Symbols glossary..... 26

Dimensions

Tire Size: 33.25 x 29

A	B	C	D	E	F	G	A	B	C	D	E	F	G
18 237 mm (717.9")	18 847 mm (742.0")	15 748 mm (620.0")	14 884 mm (585.9")	14 453 mm (569.9")	11 709 mm (460.9")	10 236 mm (402.9")	13 970 mm (550.0")	14 453 mm (569.0")	10 973 mm (432.0")	10 135 mm (399.0")	9652 mm (380.0")	6909 mm (272.0")	5918 mm (232.9")
Two-Wheel Steer							Four-Wheel Steer						

All dimensions are in mm (in).

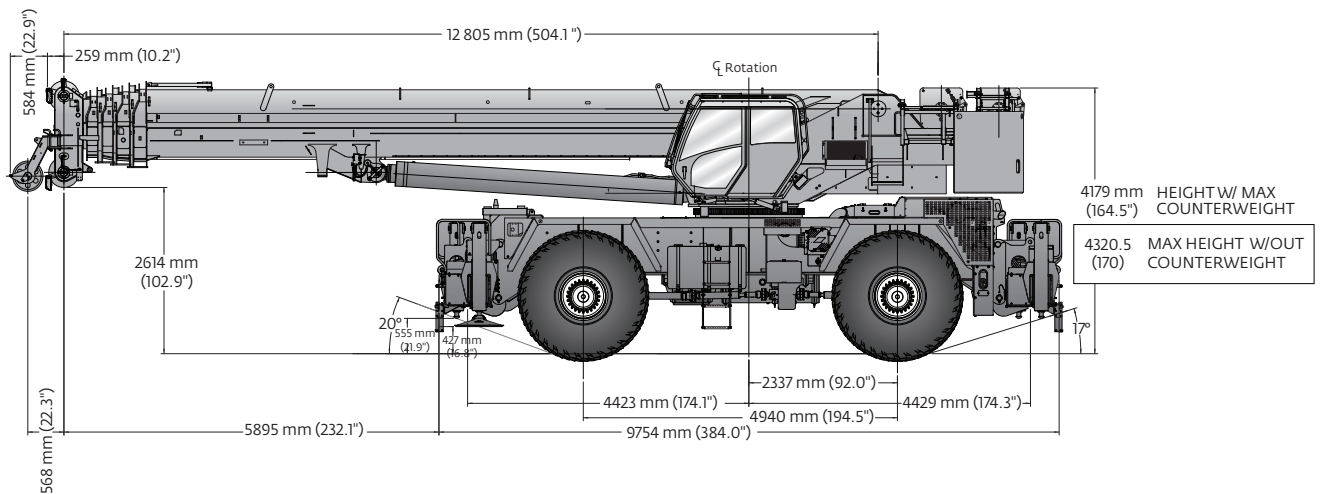
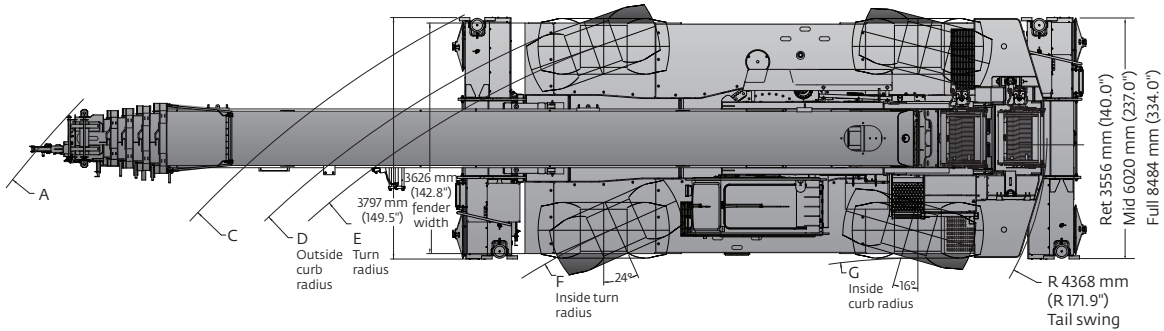

Weights

Weights						
	Gross		Front		Rear	
	kg	lb	kg	lb	kg	lb
Basic Machine: (T4F) including 72,5m (160 ft) main boom, main hoist with (431m 950 ft) of rope, auxiliary hoist with 318 m (700 ft) of wire rope, 18 144 kg (40,000 lb) counterweight, 11 m - 18 m (36 ft - 59 ft) manual extension, 9 t 10 USt) headache ball, and 72,5 t (80 USt) hook block:	79 913	176,175	36 333	80,100	43 580	96,075
Remove: 18 144 kg (40,000 lb) counterweight and auxiliary hoist and wire rope	-19 997	- 44,084	5714	12,597	-25 711	-56,681
crane weight:	59 916	132,091	42 047	92,697	17 869	39,394
Remove: 11 m - 18m (36 ft - 59 ft) manual extension	-1411	-3110	-2141	-4721	731	1611
crane weight:	58 506	128,981	39 906	87,976	18 600	41,005
Remove: 72,5 t (80 USt) hook block	-730	-1610	-694	-1531	-36	-79
crane weight:	57 775	127,371	39 211	86,445	18 564	40,926
Remove: 9,0 t (10 USt) headache ball	-330	-727	-526	-1159	196	432
crane weight:	57 446	126,644	38 686	85,286	18 760	41,358
Remove: Front outrigger box and beam	-4276	-9427	-5848	-12,892	1572	3465
crane weight:	53 170	117,217	32 838	72,394	20 332	44,823
Remove: Rear outrigger box and beam	-4276	-9427	1803	3974	-6079	-13,401
crane weight:	48 894	107,790	34 641	76,368	14 253	31,422
Remove: (4) tire / wheel assemblies	-4318	-9520	-2159	-4760	-2159	-4760
crane weight:	44 575	98,270	32 481	71,608	12 094	26,662
Remove: Main boom assembly, auxiliary boom nose, and extension brackets	-15 361	-33,865	-20 631	-45,483	5270	11,618
crane weight:	29 214	64,405	11 850	26,125	17 364	38,280

THIS CHART IS ONLY A GUIDE AND SHOULD NOT BE USED TO OPERATE THE CRANE.
The individual crane's load chart, operating instructions and other instructional plates must be read and understood prior to operating the crane

Working range

160 ft main boom + 36 ft - 59 ft fixed offset extension

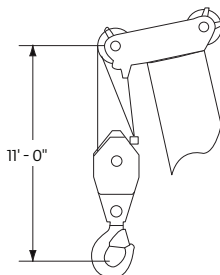
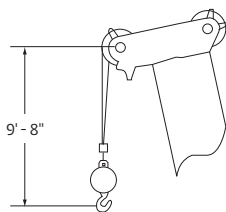
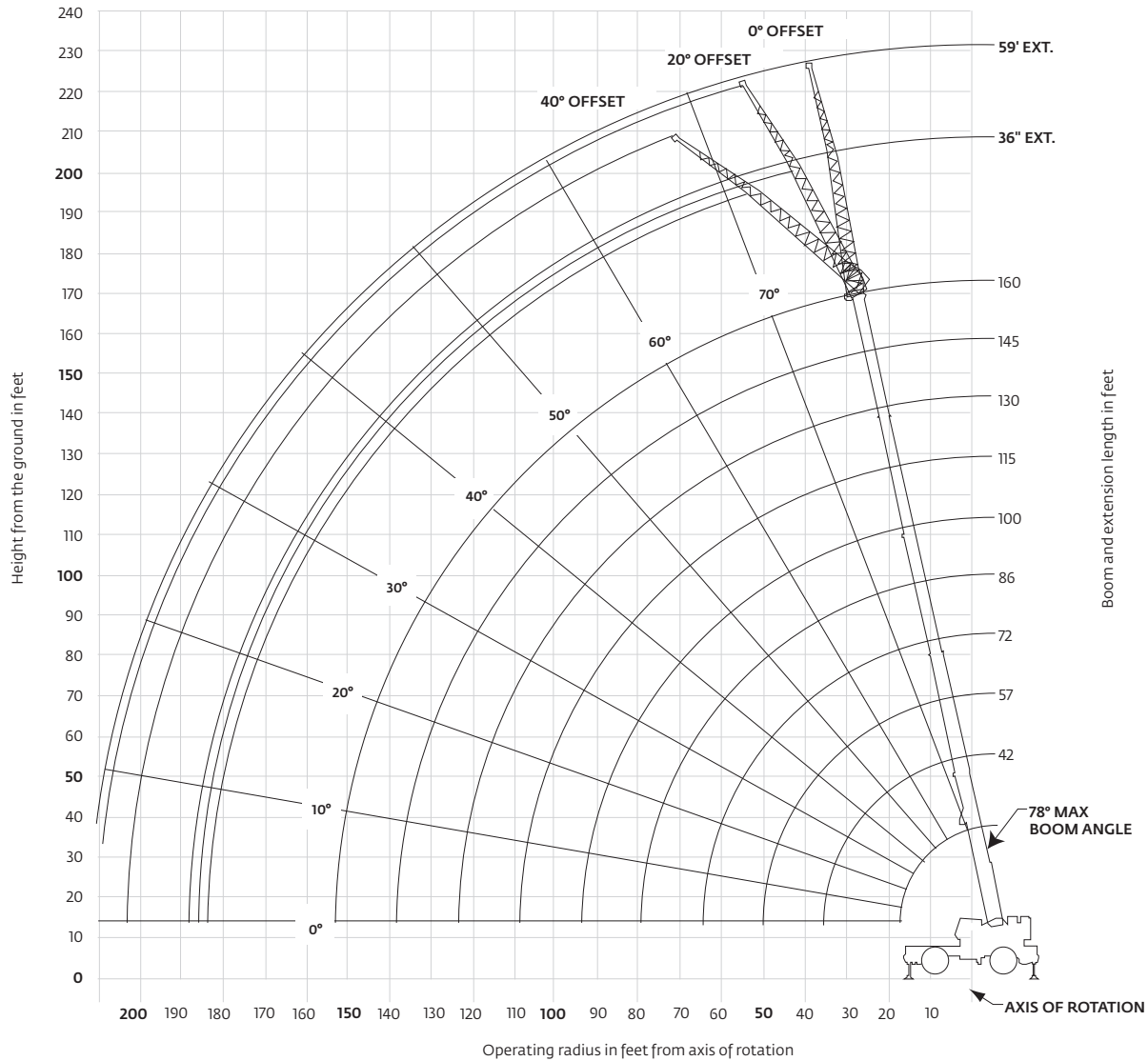

Dimensions are for largest Grove furnished hookblock and headache ball, with anti-two block activated.

*THIS CHART IS ONLY A GUIDE AND SHOULD NOT BE USED TO OPERATE THE CRANE.
The individual crane's load chart, operating instructions and other instructional plates must be read and understood prior to operating the crane*

Load chart



Feet

Feet	Main boom length in feet								
	42	57	72	86	100	115	130	145	160
10	+260,000 (71.5)	147,000 (76.5)							
12	224,000 (68.5)	147,000 (74.5)	*127,000 (78)						
15	176,000 (63.5)	147,000 (71.5)	127,000 (76)	*92,600 (78)					
20	127,500 (55.5)	125,500 (65.5)	115,500 (71.5)	86,550 (75.5)	*65,000 (78)				
25	97,300 (46)	95,550 (60)	95,300 (67)	78,900 (72)	62,650 (75)	44,600 (78)			
30	76,900 (34)	75,250 (53.5)	75,050 (62.5)	68,500 (68.5)	56,800 (72)	44,600 (75.5)	43,150 (78)		
35		60,950 (46.5)	60,750 (58)	60,100 (64.5)	50,050 (69)	44,600 (73)	42,200 (76)	32,550 (78)	
40		50,300 (38.5)	50,150 (52.5)	50,550 (60.5)	44,050 (66)	41,400 (70)	38,000 (73.5)	32,550 (76)	25,100 (78)
45		42,050 (28)	41,950 (47)	42,350 (56.5)	38,950 (62.5)	37,450 (67.5)	34,150 (71)	32,550 (74)	24,800 (76.5)
50			35,400 (41)	35,850 (52.5)	34,650 (59)	33,450 (64.5)	31,350 (68.5)	29,550 (71.5)	24,500 (74.5)
55			30,050 (34)	30,550 (47.5)	30,050 (55.5)	30,000 (61.5)	29,200 (66)	26,850 (69.5)	24,000 (72.5)
60			25,600 (24.5)	26,100 (42.5)	25,850 (52)	26,950 (58.5)	26,350 (63.5)	24,700 (67.5)	23,200 (70.5)
65				22,400 (37)	22,150 (48)	23,800 (55.5)	23,850 (61)	22,950 (65)	21,100 (68.5)
70				19,200 (30.5)	18,950 (44)	20,800 (52.5)	21,600 (58.5)	20,850 (62.5)	19,200 (66.5)
75				16,400 (22)	16,200 (39)	18,100 (49)	19,250 (55.5)	19,000 (60.5)	17,500 (64.5)
80					13,800 (34)	15,700 (45.5)	16,900 (52.5)	17,100 (58)	15,750 (62.5)
85					11,650 (28)	13,550 (41.5)	15,000 (49.5)	15,500 (55.5)	14,300 (60)
90					9770 (19.5)	11,700 (37)	13,100 (46.5)	13,900 (53)	13,100 (58)
95						10,000 (32)	11,450 (43)	12,250 (50)	12,150 (55.5)
100						8490 (26.5)	9940 (39.5)	11,000 (47)	11,400 (53)
105						5690 (18.5)	8630 (35.5)	9730 (44)	10,200 (50.5)
110							7320 (30.5)	8460 (41)	9020 (48)
115							6220 (25)	7370 (37.5)	8100 (45.5)
120							5120 (17.5)	6280 (33.5)	7190 (42.5)
125								5350 (29.5)	6270 (39.5)
130								4430 (24)	5350 (36)
135								2560 (16.5)	4560 (32.5)
140									3770 (28)
Minimum boom angle (°) for indicated length (no load)									23
Maximum boom length (ft) at 0° boom angle (no load)									145

*This capacity is based on maximum obtainable boom angle.

+16 parts line required to lift this capacity (using aux. boom nose). Refer to Operator's and Safety Handbook for reeving diagram.

NOTE: () Boom angles are in degrees

Lifting capacities at zero degree boom angle										
Boom Angle	Main boom length in feet									
	42	57	72	86	100	115	130	145	160	
0°	41,400 (35.3)	24,650 (50)	15,350 (64.6)	9700 (79.3)	5250 (94)	3650 (108.6)	2450 (123.3)	1450 (138)		

Note: () Reference radii in feet

A6-829-103576

THIS CHART IS ONLY A GUIDE AND SHOULD NOT BE USED TO OPERATE THE CRANE.

The individual crane's load chart, operating instructions and other instructional plates must be read and understood prior to operating the crane

Load chart

		Pounds					
		36 ft LENGTH			59 ft LENGTH		
Feet	Offset	0°	20°	40°	0°	20°	40°
		OFFSET	OFFSET	OFFSET	OFFSET	OFFSET	OFFSET
35		23,350 (78)					
40		23,350 (77)			12,300 (78)		
45		23,350 (75)	*21,300 (78)		12,300 (77.5)		
50		23,350 (73.5)	20,700 (76.5)		12,300 (76)		
55		23,350 (71.5)	20,100 (75)	16,600 (78)	12,300 (74.5)		
60		23,350 (69.5)	19,500 (73)	16,350 (76)	12,300 (73)	11,600 (78)	
65		22,300 (67.5)	19,000 (71)	16,100 (74)	12,300 (71.5)	11,300 (77)	
70		20,350 (66)	18,500 (69)	15,850 (72)	12,300 (69.5)	10,950 (75)	
75		18,350 (64)	18,050 (67)	15,650 (70)	12,300 (68)	10,700 (73.5)	8940 (78)
80		16,600 (62)	17,100 (65)	15,500 (68)	12,300 (66.5)	10,400 (72)	8790 (76)
85		15,050 (60)	15,550 (63)	15,300 (66)	12,300 (64.5)	10,150 (70)	8650 (74.5)
90		13,700 (57.5)	14,150 (61)	14,500 (63.5)	12,300 (63)	9910 (68.5)	8520 (72.5)
95		12,450 (55.5)	12,900 (58.5)	13,250 (61.5)	11,900 (61)	9680 (66.5)	8410 (70.5)
100		11,300 (53.5)	11,750 (56.5)	12,100 (59)	11,450 (59)	9460 (64.5)	8300 (68.5)
105		10,300 (51)	10,750 (54)	11,050 (56.5)	10,500 (57.5)	9260 (63)	8210 (66.5)
110		9390 (48.5)	9810 (52)	10,050 (54)	9580 (55.5)	9060 (61)	8120 (64.5)
115		8570 (46)	8970 (49.5)	9200 (51.5)	8790 (53.5)	8860 (59)	8050 (62.5)
120		7750 (43.5)	8140 (46.5)	8350 (48.5)	8010 (51.5)	8660 (57)	7990 (60.5)
125		6840 (41)	7360 (44)	7600 (45.5)	7340 (49.5)	7960 (54.5)	7820 (58)
130		5940 (38)	6590 (41)	6850 (42.5)	6680 (47.5)	7270 (52.5)	7660 (55.5)
135		5170 (34.5)	5730 (37.5)		6100 (45)	6660 (50.5)	7010 (53.5)
140		4400 (31)	4880 (34)		5530 (42.5)	6050 (48)	6360 (50.5)
145		3730 (27.5)	4120 (30)		4890 (40)	5510 (45.5)	5770 (48)
150		3070 (22.5)	3360 (25.5)		4260 (37.5)	4970 (42.5)	5190 (45)
155					3670 (35)	4360 (40)	
160					3090 (31.5)	3750 (36.5)	
165					2570 (28.5)	3120 (33)	
170					2060 (24.5)	2490 (29)	
Min. boom angle for indicated length (no load)		20°	20°	40°	20°	20°	40°
Max. boom length (ft) at 0° boom angle (no load)		100 ft			100 ft		

A6-829-102127

NOTE: () Boom angles are in degrees

*This capacity is based on maximum obtainable boom angle.

NOTES:

- All capacities above the bold line are based on structural strength of boom extension and do not exceed 85% of tipping loads, in accordance with SAE J-765.
- 36 ft boom extension may be used for single or double line lifting service. 59 ft boom extension may be used for single line lifting service only.
WARNING: Lifting with the 36 ft extension base, with the 23 ft extension fly either erected or folded along side of extension base, is strictly prohibited.
- Radii listed are for a fully extended boom with the boom extension erected. For main boom lengths less than fully extended, the rated loads are determined by boom angle. Use only the column which corresponds to the boom extension length and offset for which the machine is configured. For boom angles not shown, use the rating of the next lower boom angle.
WARNING: Operation of this machine with heavier loads than the capacities listed is strictly prohibited. Machine tipping with boom extension occurs rapidly and without advance warning.
- Boom angle is the angle above or below horizontal of the longitudinal axis of the boom base section after lifting rated load.
- Capacities listed are with outriggers properly extended and vertical jacks set only.

THIS CHART IS ONLY A GUIDE AND SHOULD NOT BE USED TO OPERATE THE CRANE.

The individual crane's load chart, operating instructions and other instructional plates must be read and understood prior to operating the crane

Load chart

Pounds						
Feet	36 ft LENGTH			59 ft LENGTH		
	0° OFFSET	20° OFFSET	40° OFFSET	0° OFFSET	20° OFFSET	40° OFFSET
45	16,000 (78)					
50	16,000 (77.5)					
55	15,900 (76)			10,100 (78)		
60	15,850 (74)	15,700 (77.5)		10,100 (77)		
65	15,800 (72.5)	15,700 (76)	*15,200 (78)	10,100 (75.5)		
70	15,750 (71)	15,000 (74.5)	14,750 (77)	10,100 (74)	10,050 (78)	
75	14,950 (69.5)	14,300 (73)	14,100 (75.5)	10,100 (73)	10,050 (77.5)	
80	14,200 (68)	13,600 (71)	13,450 (74)	10,100 (71.5)	10,050 (76)	
85	13,450 (66)	12,950 (69.5)	12,850 (72)	10,100 (70)	10,050 (74.5)	8600 (78)
90	12,800 (64.5)	12,350 (68)	12,250 (70.5)	10,100 (68.5)	9870 (73)	8500 (77.5)
95	11,700 (63)	11,750 (66)	11,700 (68.5)	10,100 (67)	9680 (72)	8400 (75.5)
100	10,650 (61)	11,200 (64.5)	11,200 (67)	9710 (65.5)	9450 (70)	8310 (74)
105	9710 (59.5)	10,250 (62.5)	10,400 (65)	9280 (64)	9050 (68.5)	8220 (72.5)
110	8780 (57.5)	9310 (61)	9680 (63)	8850 (62.5)	8650 (67)	8140 (71)
115	7990 (55.5)	8500 (59)	8840 (61)	8110 (61)	8280 (65.5)	7920 (69.5)
120	7210 (53.5)	7690 (57)	8010 (59)	7370 (59.5)	7920 (64)	7700 (67.5)
125	6540 (52)	7000 (55)	7290 (57)	6720 (57.5)	7360 (62.5)	7440 (66)
130	5880 (49.5)	6310 (53)	6580 (55)	6070 (56)	6810 (60.5)	7190 (64)
135	5300 (47.5)	5710 (51)	5950 (53)	5510 (54.5)	6210 (59)	6630 (62.5)
140	4730 (45.5)	5110 (49)	5330 (50.5)	4950 (52.5)	5620 (57)	6080 (60.5)
145	4190 (43)	4580 (46.5)	4770 (48)	4460 (50.5)	5100 (55.5)	5520 (58.5)
150	3650 (41)	4060 (44)	4220 (45.5)	3980 (49)	4580 (53.5)	4970 (56.5)
155	3070 (38.5)	3500 (41.5)	3660 (43)	3550 (47)	4120 (51.5)	4470 (54.5)
160	2490 (35.5)	2940 (38.5)		3130 (45)	3660 (49.5)	3970 (52)
165	1970 (32.5)	2370 (36)		2710 (43)	3240 (47.5)	3510 (50)
170	1460 (29.5)	1800 (32.5)		2300 (40.5)	2830 (45)	3060 (47.5)
175				1840 (38.5)	2420 (43)	2640 (45)
180				1390 (36)	2010 (40)	2220 (42)
185					1530 (37.5)	
Min. boom angle for indicated length (no load)	26	28	40	34	35	40
Max. boom length (ft) at 0° boom angle (no load)		100			100	

NOTE: () Boom angles are in degrees A6-829-101980A
 *This capacity is based on maximum obtainable boom angle.

NOTES:

- All capacities above the bold line are based on structural strength of boom extension and do not exceed 85% of tipping loads, in accordance with SAE J-765.
- 36 ft boom extension may be used for single or double line lifting service. 59 ft boom extension may be used for single line lifting service only.
WARNING: Lifting with the 36 ft extension base, with the 23 ft extension fly either erected or folded along side of extension base, is strictly prohibited.
- Radii listed are for a fully extended boom with the boom extension erected. For main boom lengths less than fully extended, the rated loads are determined by boom angle. Use only the column which corresponds to the boom extension length and offset for which the machine is configured. For boom angles not shown, use the rating of the next lower boom angle.
WARNING: Operation of this machine with heavier loads than the capacities listed is strictly prohibited. Machine tipping with boom extension occurs rapidly and without advance warning.
- Boom angle is the angle above or below horizontal of the longitudinal axis of the boom base section after lifting rated load.
- Capacities listed are with outriggers properly extended and vertical jacks set only.

THIS CHART IS ONLY A GUIDE AND SHOULD NOT BE USED TO OPERATE THE CRANE.

The individual crane's load chart, operating instructions and other instructional plates must be read and understood prior to operating the crane

Working range

160 ft main boom + 2 inserts + 36 ft - 59 ft fixed offset extension

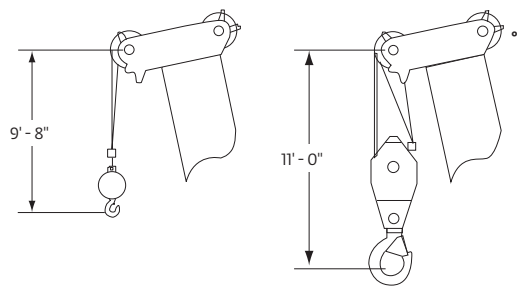
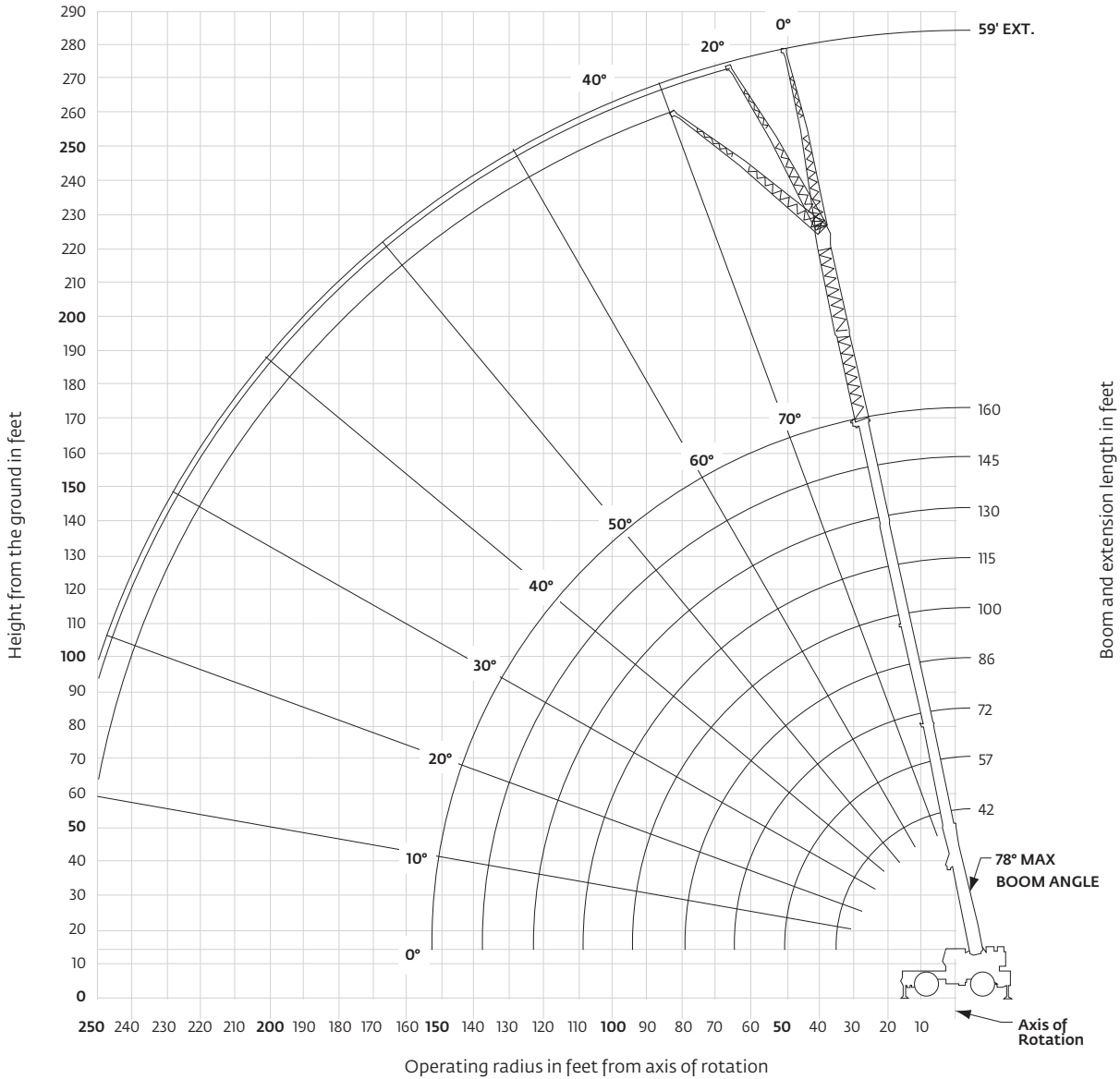

Dimensions are for largest Grove furnished hook block and headache ball, with anti-two block activated.

THIS CHART IS ONLY A GUIDE AND SHOULD NOT BE USED TO OPERATE THE CRANE. The individual crane's load chart, operating instructions and other instructional plates must be read and understood prior to operating the crane

Load chart

Feet	Pounds					
	59 ft LENGTH WITH 26 ft INSERT			59 ft LENGTH WITH 52 ft INSERT		
	0° OFFSET	20° OFFSET	40° OFFSET	0° OFFSET	20° OFFSET	40° OFFSET
60	7070 (78)					
65	7070 (77.5)					
70	7070 (76.5)			4400 (78)		
75	7070 (75)			4400 (77.5)		
80	7070 (74)	6610 (78)		4400 (76.5)		
85	7070 (72.5)	6610 (77.5)		4400 (75.5)		
90	7070 (71.5)	6610 (76)		4400 (74.5)	4230 (78)	
95	7070 (70)	6610 (75)	6400 (78)	4400 (73)	4230 (77.5)	
100	7070 (69)	6610 (73.5)	6400 (77)	4400 (72)	4230 (76.5)	
105	7070 (67.5)	6610 (72.5)	6400 (76)	4400 (71)	4230 (75.5)	4000 (78)
110	7070 (66)	6610 (71)	6400 (74.5)	4400 (69.5)	4230 (74)	4000 (77)
115	6735 (65)	6545 (69.5)	6315 (73)	4400 (68.5)	4230 (73)	4000 (75.5)
120	6400 (63.5)	6480 (68)	6230 (71.5)	4400 (67.5)	4230 (72)	4000 (74.5)
125	5940 (62)	6170 (67)	5955 (70)	4400 (66)	4230 (70.5)	4000 (73)
130	5480 (60.5)	5860 (65.5)	5680 (68.5)	4400 (65)	4230 (69.5)	4000 (72)
135	4930 (59.5)	5510 (64)	5440 (67)	4110 (63.5)	4195 (68)	4000 (70.5)
140	4380 (58)	5160 (62.5)	5200 (65.5)	3820 (62.5)	4160 (67)	4000 (69)
145	3900 (56.5)	4645 (61)	4910 (64)	3350 (61)	3885 (65.5)	3785 (68)
150	3420 (55)	4130 (59.5)	4620 (62.5)	2880 (60)	3610 (64)	3570 (66.5)
155	3000 (53.5)	3680 (58)	4140 (60.5)	2470 (58.5)	3205 (63)	3365 (65)
160	2580 (51.5)	3230 (56.5)	3660 (59)	2060 (57)	2800 (61.5)	3160 (63.5)
165	2210 (50)	2825 (54.5)	3220 (57.5)	1690 (56)	2405 (60)	2810 (62.5)
170	1840 (48.5)	2420 (53)	2780 (55.5)		2010 (59)	2460 (61)
175	1515 (46.5)	2060 (51)	2385 (53.5)		1655 (57.5)	2075 (59.5)
180		1700 (49.5)	1990 (51.5)			1690 (58)
185		1370 (47.5)	1625 (49.5)			
Min. boom angle for indicated length (no load)	45	46	48	54	56	56
Max. boom length (ft) at 0° boom angle (no load)		57			57	

NOTE: () Boom angles are in degrees

A6-829-101983A

NOTES:

- All capacities above the bold line are based on structural strength of boom extension and do not exceed 85% of tipping loads, in accordance with SAE J-765.
- 59 ft folding boom extension length may be used for single line lifting service only. Note: Lifting with the 36 ft extension base with either one or two 26 ft insert sections installed is not permitted.
- For main boom lengths less than 160 ft with the boom extension erected, the rated loads are determined by boom angle. Use only the column which corresponds to the boom extension length and offset for which the machine is set up. For boom angles not shown, use the rating of the next lower boom angle.
- WARNING:** Operation of this machine with heavier loads than the capacities listed is strictly prohibited. Machine tipping with boom extension occurs rapidly and without advance warning.
- Boom angle is the angle above or below horizontal of the longitudinal axis of the boom base section after lifting rated load.
- Capacities listed are with outriggers properly extended and vertical jacks set only.

THIS CHART IS ONLY A GUIDE AND SHOULD NOT BE USED TO OPERATE THE CRANE.

The individual crane's load chart, operating instructions and other instructional plates must be read and understood prior to operating the crane

Load chart

Feet	Main boom length in feet			
	42	57	72	86
10	61,750 (71.5)			
12	61,750 (68.5)			
15	49,000 (63.5)	34,600 (71.5)		
20	34,750 (55.5)	34,600 (65.5)		
25	34,750 (46)	34,600 (60)		
30	29,250 (34)	28,150 (53.5)	28,300 (62.5)	
35	23,400 (13)	22,350 (46.5)	22,500 (58)	24,100 (64.5)
40		17,750 (38.5)	17,800 (52.5)	19,250 (60.5)
45		14,000 (28)	13,950 (47)	15,200 (56.5)
50		10,950 (7.5)	10,800 (41)	11,850 (52.5)
55			8150 (34)	9020 (47.5)
60			5880 (24.5)	6600 (42.5)
65				4520 (37)
70				2700 (30.5)
75				1110 (22)
Min. boom angle for indicated length (no load)			0	20
Max. boom length (ft) at 0° boom angle (no load)				72

NOTE: () Boom angles are in degrees

Lifting capacities at zero degree boom angle		
Boom angle	42	57
0°	23,000 (35.3)	10,900 (50)

A6-829-102108A

NOTES:

1. Capacities are in pounds and do not exceed 75% of tipping loads as determined by test in accordance with SAE J-765.
2. Capacities are applicable to machines equipped with 33.25x29 (38 ply) bias ply tires, at 85 psi cold inflation pressure.
3. Capacities appearing above the bold line are based on structural strength and tipping should not be relied upon as a capacity limitation.
4. Capacities are applicable only with machine on firm level surface.
5. On rubber lifting with boom extension not permitted.
6. Axle lockouts must be functioning when lifting on rubber.
7. For pick and carry operation, boom must be centered over front of machine, mechanical swing lock engaged and load restrained from swinging. When handling loads in the structural range with capacities close to maximum ratings, travel should be reduced to creep speeds.
8. All lifting depends on proper tire inflation, capacity and condition. Capacities must be reduced for lower tire inflation pressures. See lifting capacity chart for tire used. Damaged tires are hazardous to safe operation of crane.
9. Creep – not over 200 ft of movement in any 30 minute period and not exceeding 1 mph.

THIS CHART IS ONLY A GUIDE AND SHOULD NOT BE USED TO OPERATE THE CRANE.

The individual crane's load chart, operating instructions and other instructional plates must be read and understood prior to operating the crane

Working range

160 ft main boom + 36 ft - 59 ft luffing extension

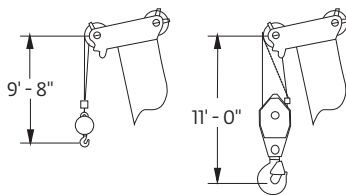
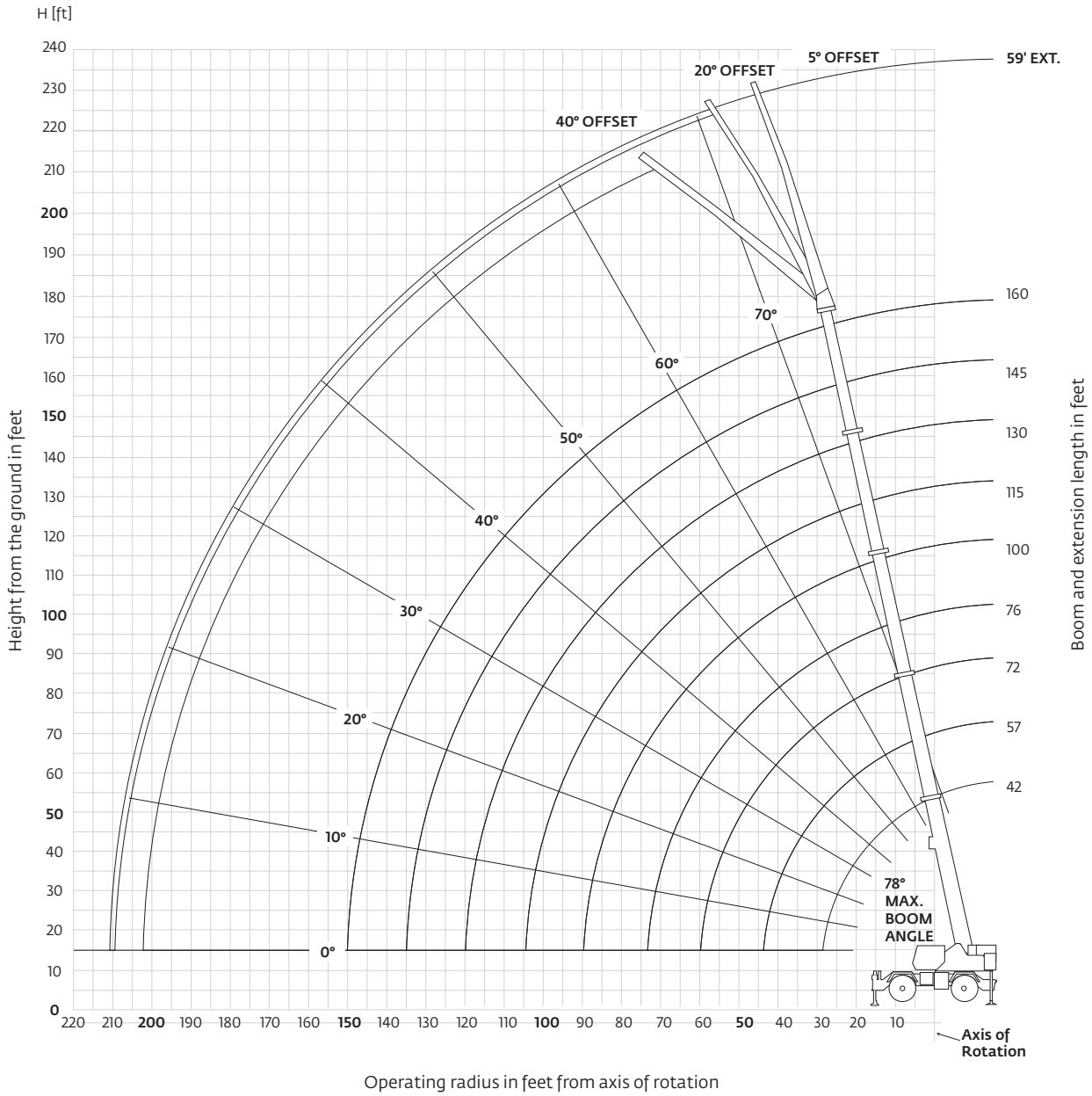

Dimensions are for largest Grove furnished hook block and headache ball, with anti-two block activated.

*THIS CHART IS ONLY A GUIDE AND SHOULD NOT BE USED TO OPERATE THE CRANE.
The individual crane's load chart, operating instructions and other instructional plates must be read and understood prior to operating the crane*

Working range

160 ft main boom + 2 inserts + 36 ft - 59 ft luffing extension

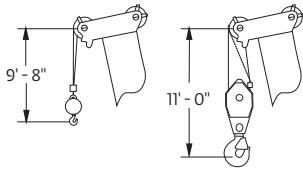
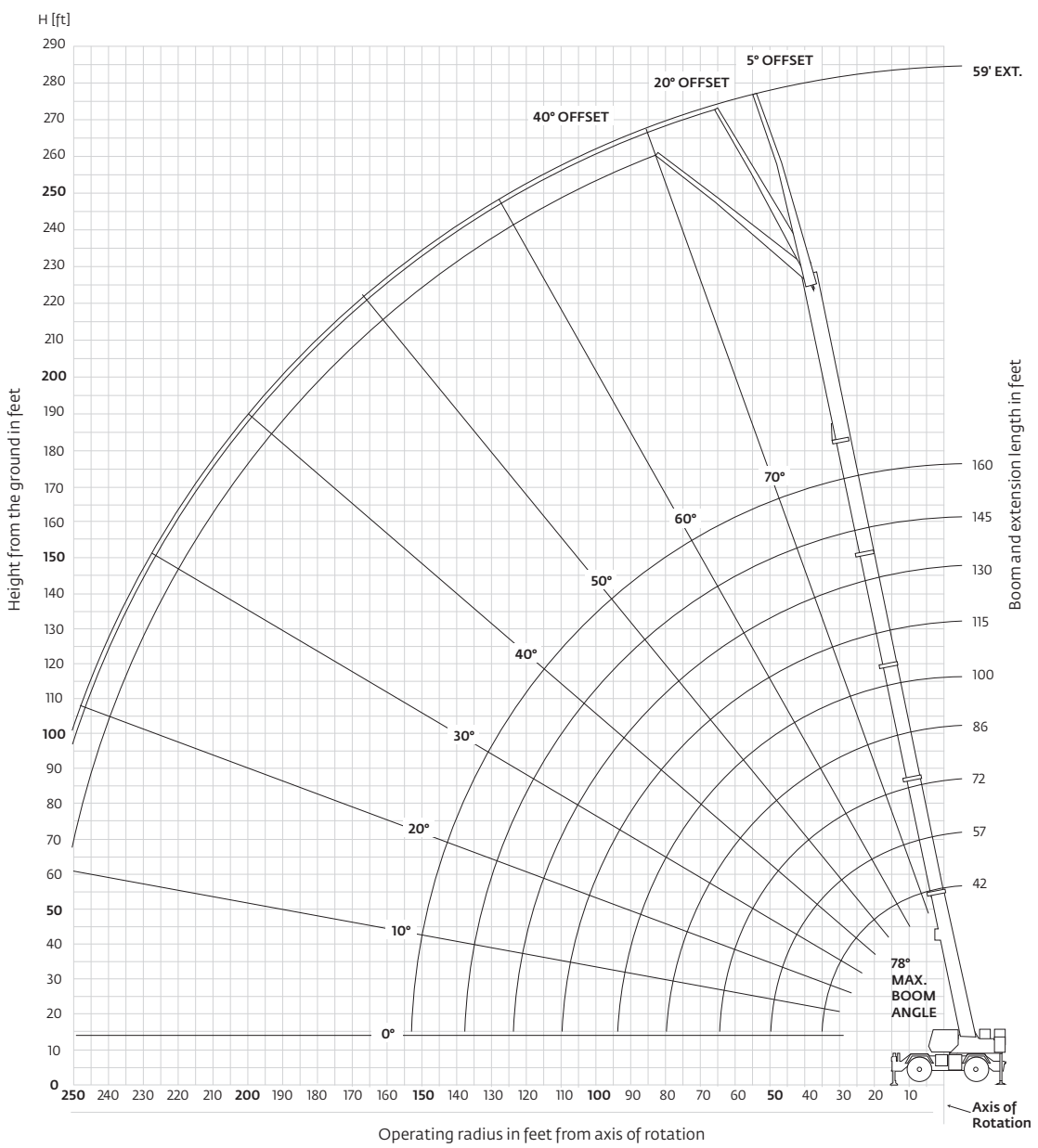

Dimensions are for largest Grove furnished hook block and headache ball, with anti-two block activated.

THIS CHART IS ONLY A GUIDE AND SHOULD NOT BE USED TO OPERATE THE CRANE. The individual crane's load chart, operating instructions and other instructional plates must be read and understood prior to operating the crane

Load chart

36 ft - 59 ft luffing folding boom extension (fixed angle) 100 ft main boom



Feet _____ Pounds _____

Feet	36 ft LENGTH			59 ft LENGTH		
	5° OFFSET	20° OFFSET	40° OFFSET	5° OFFSET	20° OFFSET	40° OFFSET
30	32,600 (78)					
35	30,700 (76)	*23,150 (78)				
40	28,950 (74)	22,150 (76.5)		14,950 (77.5)		
45	27,350 (71.5)	21,250 (74)	15,250 (78)	14,950 (75.5)		
50	25,900 (69.5)	20,450 (72)	14,850 (75.5)	14,950 (73.5)	12,350 (78)	
55	24,600 (67)	19,700 (69.5)	14,500 (73)	14,550 (72)	11,900 (77)	
60	23,400 (64.5)	19,050 (67)	14,200 (70.5)	14,150 (70)	11,500 (75)	
65	22,300 (62)	18,450 (65)	13,900 (68)	13,750 (68)	11,100 (73)	8050 (78)
70	21,300 (59.5)	17,850 (62)	13,650 (65.5)	13,350 (66)	10,700 (71)	7850 (76)
75	20,100 (57)	17,350 (59.5)	13,450 (63)	13,000 (64)	10,400 (69)	7660 (73.5)
80	18,100 (54.5)	16,900 (57)	13,300 (60)	12,550 (61.5)	10,050 (66.5)	7490 (71.5)
85	16,000 (51.5)	16,500 (54)	13,150 (57)	12,000 (59.5)	9780 (64.5)	7340 (69)
90	14,150 (49)	15,400 (51.5)	13,050 (54)	11,550 (57.5)	9510 (62.5)	7210 (66.5)
95	12,500 (46)	13,700 (48)	13,000 (50.5)	11,100 (55)	9,260 (60)	7090 (64)
100	11,050 (42.5)	12,100 (45)	12,750 (47)	10,650 (52.5)	9030 (57.5)	6980 (61.5)
105	9770 (39)	10,650 (41.5)		10,250 (50)	8820 (55)	6900 (59)
110	8490 (35.5)	9270 (37.5)		9930 (47.5)	8620 (52.5)	6830 (56)
115	7400 (31)	8060 (33)		9040 (45)	8440 (49.5)	6790 (53)
120	6320 (26)	6850 (28)		8150 (42)	8260 (47)	6750 (50)
125				7240 (39)	7820 (43.5)	
130				6340 (35.5)	7380 (40.5)	
135				5570 (32)	6440 (36.5)	
140				4800 (28)	5510 (32)	
145				4100 (23)		
150				3410 (16)		
Min. boom angle for indicated length (no load)	5°	20°	40°	5°	20°	40°
Max. boom length (ft) at 5° boom angle (no load)		100 ft		100 ft		

NOTE: () Boom angles are in degrees. A6-829-102550
 *This capacity is based on maximum obtainable boom angle.

NOTES:

- All capacities above the bold line are based on structural strength of boom extension.
- 36 ft boom extension may be used for single or double line lifting service. 59 ft boom extension may be used for single line lifting service only.
WARNING: Lifting with the 36 ft extension base, with the 23 ft extension fly either erected or folded along side of extension base, is strictly prohibited.
- Radii listed are for a 100 ft boom with the boom extension erected. For main boom lengths less than 100 ft, the rated loads are determined by boom angle. Use only the column which corresponds to the boom extension length and offset for which the machine is configured. For boom angles not shown, use the rating of the next lower boom angle.
WARNING: Operation of this machine with heavier loads than the capacities listed is strictly prohibited. Machine tipping with boom extension occurs rapidly and without advance warning.
- Boom angle is the angle above or below horizontal of the longitudinal axis of the boom base section after lifting rated load.
- Capacities listed are with outriggers properly extended and vertical jacks set only.

THIS CHART IS ONLY A GUIDE AND SHOULD NOT BE USED TO OPERATE THE CRANE.

The individual crane's load chart, operating instructions and other instructional plates must be read and understood prior to operating the crane

Load chart

36 ft - 59 ft luffing folding boom extension (fixed angle) 130 ft main boom

Feet	Pounds					
	36 ft LENGTH			59 ft LENGTH		
	5° OFFSET	20° OFFSET	40° OFFSET	5° OFFSET	20° OFFSET	40° OFFSET
40	*23,350 (78)					
45	23,350 (76)	*21,300 (78)		*12,300 (78)		
50	23,350 (74)	20,700 (76.5)			12,300 (77.5)	
55	23,350 (72.5)	20,100 (75)	14,850 (78)	12,300 (76)		
60	23,350 (70.5)	19,500 (73)	14,550 (76)	12,300 (74.5)	11,600 (78)	
65	22,300 (68.5)	19,000 (71)	14,300 (74)	12,300 (73)	11,300 (77)	
70	20,350 (66.5)	18,500 (69)	14,050 (72)	12,300 (71)	10,950 (75)	
75	18,350 (64.5)	18,050 (67)	13,850 (70)	12,300 (69.5)	10,700 (73.5)	7850 (78)
80	16,600 (62.5)	17,000 (65)	13,650 (68)	12,300 (68)	10,400 (72)	7690 (76)
85	15,050 (60.5)	15,450 (63)	13,450 (66)	12,300 (66)	10,150 (70)	7550 (74.5)
90	13,650 (58.5)	14,050 (61)	13,300 (63.5)	12,250 (64.5)	9910 (68.5)	7420 (72.5)
95	12,400 (56.5)	12,800 (58.5)	13,150 (61.5)	11,900 (62.5)	9680 (66.5)	7300 (70.5)
100	11,300 (54)	11,650 (56.5)	11,950 (59)	11,450 (61)	9460 (64.5)	7190 (68.5)
105	10,300 (52)	10,650 (54)	10,950 (56.5)	10,500 (59)	9,260 (63)	7090 (66.5)
110	9340 (49.5)	9660 (52)	9950 (54)	9580 (57)	9060 (61)	7000 (64.5)
115	8480 (47)	8810 (49.5)	9070 (51.5)	8790 (55)	8800 (59)	6930 (62.5)
120	7630 (44.5)	7970 (46.5)	8200 (48.5)	8010 (53)	8550 (57)	6860 (60.5)
125	6700 (41.5)	7240 (44)	7430 (45.5)	7340 (51)	7840 (54.5)	6810 (58)
130	5780 (39)	6510 (41)	6670 (42.5)	6680 (49)	7140 (52.5)	6770 (55.5)
135	4980 (35.5)	5690 (37.5)		6100 (46.5)	6520 (50.5)	6500 (53.5)
140	4190 (32)	4880 (34)		5520 (44)	5910 (48)	6240 (50.5)
145	3500 (28)	4120 (30)		4860 (42)	5360 (45.5)	5640 (48)
150	2820 (23.5)	3360 (25.5)		4200 (39)	4820 (42.5)	5050 (45)
155				3580 (36.5)	4280 (40)	
160				2970 (33.5)	3750 (36.5)	
165				2430 (30)	3120 (33)	
170				1890 (26)	2490 (29)	

Min. boom angle for indicated length (no load)

20°	20°	40°	20°	20°	40°
-----	-----	-----	-----	-----	-----

Max. boom length (ft) at 5° boom angle (no load)

100 ft	100 ft
--------	--------

NOTE: () Boom angles are in degrees. A6-829-102554

*This capacity is based on maximum obtainable boom angle.

NOTES:

- All capacities above the bold line are based on structural strength of boom extension.
- 36 ft boom extension may be used for single or double line lifting service. 59 ft boom extension may be used for single line lifting service only. **WARNING:** Lifting with the 36 ft extension base, with the 23 ft extension fly either erected or folded along side of extension base, is strictly prohibited.
- Radii listed are for a 130 ft boom with the boom extension erected. For main boom lengths less than 130 ft, the rated loads are determined by boom angle. Use only the column which corresponds to the boom extension length and offset for which the machine is configured. For boom angles not shown, use the rating of the next lower boom angle. **WARNING:** Operation of this machine with heavier loads than the capacities listed is strictly prohibited. Machine tipping with boom extension occurs rapidly and without advance warning.
- Boom angle is the angle above or below horizontal of the longitudinal axis of the boom base section after lifting rated load.
- Capacities listed are with outriggers properly extended and vertical jacks set only.

THIS CHART IS ONLY A GUIDE AND SHOULD NOT BE USED TO OPERATE THE CRANE.

The individual crane's load chart, operating instructions and other instructional plates must be read and understood prior to operating the crane

Load chart

36 ft - 59 ft luffing folding boom extension (fixed angle) 160 ft main boom

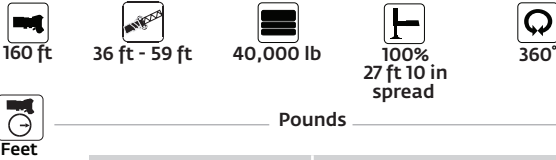

Feet	Pounds					
	36 ft LENGTH			59 ft LENGTH		
	5° OFFSET	20° OFFSET	40° OFFSET	5° OFFSET	20° OFFSET	40° OFFSET
50	15,550 (77.5)					
55	15,550 (76)					
60	15,550 (74.5)	14,950 (77.5)		9650 (78)		
65	15,550 (73)	14,950 (76)	*14,400 (78)	9650 (77)		
70	15,550 (71.5)	14,950 (74.5)	14,150 (77)	9650 (75.5)	9650 (78)	
75	14,900 (70)	14,250 (73)	13,950 (75.5)	9650 (74)	9650 (77.5)	
80	14,100 (68)	13,550 (71)	13,400 (74)	9650 (72.5)	9650 (76)	
85	13,400 (66.5)	12,900 (69.5)	12,800 (72)	9650 (71)	9650 (74.5)	7630 (78)
90	12,700 (65)	12,250 (70.5)	12,200 (70.5)	9650 (69.5)	9650 (73)	7510 (77.5)
95	11,500 (63)	11,700 (66)	11,650 (68.5)	9650 (68.5)	9650 (72)	7390 (75.5)
100	10,400 (61.5)	10,850 (64.5)	11,100 (67)	9570 (67)	9420 (70)	7290 (74)
105	9480 (59.5)	9910 (62.5)	10,200 (65)	9150 (65)	9010 (68.5)	7200 (72.5)
110	8570 (58)	8970 (61)	9360 (63)	8730 (63.5)	8610 (67)	7110 (71)
115	7780 (56)	8160 (59)	8530 (61)	8000 (62)	8220 (65.5)	7030 (69.5)
120	6990 (54)	7360 (57)	7700 (59)	7280 (60.5)	7840 (64)	6950 (67.5)
125	6320 (52)	6670 (55)	6980 (57)	6620 (59)	7180 (62.5)	6890 (66)
130	5650 (50)	5980 (53)	6260 (55)	5970 (57.5)	6530 (60.5)	6830 (64)
135	5070 (48)	5380 (51)	5630 (53)	5400 (55.5)	5930 (59)	6320 (62.5)
140	4500 (46)	4780 (49)	5010 (50.5)	4830 (54)	5340 (57)	5820 (60.5)
145	3990 (43.5)	4250 (46.5)	4450 (48)	4340 (52)	4820 (55.5)	5260 (58.5)
150	3490 (41.5)	3730 (44)	3900 (45.5)	3850 (50)	4300 (53.5)	4710 (56.5)
155	2990 (38.5)	3260 (41.5)		3410 (48)	3840 (51.5)	4210 (54.5)
160	2490 (36)	2800 (38.5)		2980 (46)	3380 (49.5)	3710 (52)
165	1970 (33)	2300 (36)		2590 (44)	2960 (47.5)	3250 (50)
170	1450 (30)	1800 (32.5)		2210 (42)	2550 (45)	2790 (47.5)
175				1800 (39.5)	2170 (43)	
180				1390 (37.5)	1800 (40)	
185					1420 (37.5)	
Min. boom angle for indicated length (no load)	26°	29°	40°	34°	36°	40°
Max. boom length (ft) at 5° boom angle (no load)		100 ft		100 ft		

NOTE: () Boom angles are in degrees. A6-829-102558
 *This capacity is based on maximum obtainable boom angle.

NOTES:

- All capacities above the bold line are based on structural strength of boom extension and do not exceed 85% of tipping loads, in accordance with SAE J765.
- 36 ft boom extension may be used for single or double line lifting service. 59 ft boom extension may be used for single line lifting service only. **WARNING:** Lifting with the 36 ft extension base, with the 23 ft extension fly either erected or folded along side of extension base, is strictly prohibited.
- Radii listed are for a 160 ft boom with the boom extension erected. For main boom lengths less than 160 ft, the rated loads are determined by boom angle. Use only the column which corresponds to the boom extension length and offset for which the machine is configured. For boom angles not shown, use the rating of the next lower boom angle. **WARNING:** Operation of this machine with heavier loads than the capacities listed is strictly prohibited. Machine tipping with boom extension occurs rapidly and without advance warning.
- Boom angle is the angle above or below horizontal of the longitudinal axis of the boom base section after lifting rated load.
- Capacities listed are with outriggers properly extended and vertical jacks set only.

THIS CHART IS ONLY A GUIDE AND SHOULD NOT BE USED TO OPERATE THE CRANE.

The individual crane's load chart, operating instructions and other instructional plates must be read and understood prior to operating the crane

Load chart

59 ft luffing folding boom extension with 1 or 2 inserts (fixed angle) 160 ft main boom

Feet	Pounds					
	59 ft LENGTH WITH 26 ft INSERT			59 ft LENGTH WITH 52 ft INSERT		
	5° OFFSET	20° OFFSET	40° OFFSET	5° OFFSET	20° OFFSET	40° OFFSET
70	6830 (78)					
75	6830 (77)			4400 (78)		
80	6830 (75.5)	6610 (78)		4400 (77.5)		
85	6830 (74.5)	6610 (77.5)		4400 (76.5)		
90	6830 (73)	6610 (76)		4400 (75.5)	4230 (78)	
95	6830 (72)	6610 (75)	6400 (77.5)	4400 (74.5)	4230 (77.5)	
100	6830 (70.5)	6610 (73.5)	6400 (77)	4400 (73)	4230 (76.5)	
105	6830 (69.5)	6610 (72.5)	6400 (76)	4400 (72)	4230 (75.5)	4000 (78)
110	6830 (68)	6610 (71)	6400 (74.5)	4400 (71)	4230 (74)	4000 (77)
115	6590 (66.5)	6520 (69.5)	6310 (73)	4400 (69.5)	4230 (73)	4000 (75.5)
120	6350 (65)	6430 (68)	6230 (71.5)	4400 (68.5)	4230 (72)	4000 (74.5)
125	5910 (64)	6120 (67)	5950 (70)	4400 (67.5)	4230 (70.5)	4000 (73)
130	5480 (62.5)	5810 (65.5)	5680 (68.5)	4400 (66)	4230 (69.5)	4000 (72)
135	4930 (61)	5480 (64)	5430 (67)	4110 (65)	4170 (68)	4000 (70.5)
140	4380 (59.5)	5160 (62.5)	5190 (65.5)	3820 (63.5)	4120 (67)	4000 (69)
145	3900 (58)	4640 (61)	4900 (64)	3350 (62.5)	3860 (65.5)	3780 (68)
150	3420 (56.5)	4130 (59.5)	4620 (62.5)	2880 (61)	3610 (64)	3570 (66.5)
155	3000 (55)	3680 (58)	4140 (60.5)	2470 (59.5)	3200 (63)	3360 (65)
160	2580 (53.5)	3230 (56.5)	3660 (59)	2060 (58.5)	2800 (61.5)	3160 (63.5)
165	2210 (52)	2820 (54.5)	3220 (57.5)	1690 (57)	2400 (60)	2810 (62.5)
170	1840 (50)	2420 (53)	2780 (55.5)		2010 (59)	2460 (61)
175	1510 (48.5)	2060 (51)	2380 (53.5)		1650 (57.5)	2070 (59.5)
180		1700 (49.5)	1990 (51.5)			1690 (58)
Min. boom angle for indicated length (no load)	46°	46°	48°	55°	56°	56°
Max. boom length (ft) at 5° boom angle (no load)		57 ft			57 ft	

NOTE: () Boom angles are in degrees.

A6-829-102562

NOTES:

- All capacities above the bold line are based on structural strength of boom extension and do not exceed 85% of tipping loads, in accordance with SAE J-765.
- 59 ft folding boom extension length may be used for single line lifting service only.
NOTE: Lifting with the 36 ft extension base with either one or two 26 ft insert sections installed is not permitted.
- For main boom lengths less than 160 ft with the boom extension erected, the rated loads are determined by boom angle. Use only the column which corresponds to the boom extension length and offset for which the machine is set up. For boom angles not shown, use the rating of the next lower boom angle.
- WARNING:** Operation of this machine with heavier loads than the capacities listed is strictly prohibited. Machine tipping with boom extension occurs rapidly and without advance warning.
- Boom angle is the angle above or below horizontal of the longitudinal axis of the boom base section after lifting rated load.
- Capacities listed are with outriggers properly extended and vertical jacks set only.

THIS CHART IS ONLY A GUIDE AND SHOULD NOT BE USED TO OPERATE THE CRANE.

The individual crane's load chart, operating instructions and other instructional plates must be read and understood prior to operating the crane

Load chart

36 ft - 59 ft luffing folding boom extension 160 ft main boom (load luffing)



Feet	36 ft LENGTH		59 ft LENGTH	
	5° - 20° OFFSET	20° - 40° OFFSET	5° - 20° OFFSET	20° - 40° OFFSET
60	14,950			
65	14,950	10,250		
70	14,950	10,050	9650	
75	14,250	9840	9320	
80	13,550	9640	8950	
85	12,900	9460	8600	5100
90	12,250	9280	8290	4980
95	11,500	9130	7990	4880
100	10,400	8980	7720	4780
105	9480	8850	7470	4690
110	8570	8720	7220	4600
115	7780	8160	7010	4520
120	6990	7360	6790	4440
125	6320	6670	6600	4370
130	5650	5980	5970	4310
135	5070	5380	5400	4250
140	4500	4780	4830	4200
145	3990	4250	4340	4160
150	3490	3730	3850	4120
155	2990		3410	3840
160	2490		2980	3380
165	1970		2590	2960
170	1450		2210	2550
175			1800	
180			1390	
Min. boom angle for indicated length (no load)	29°	40°	36°	40°
Max. boom length (ft) at 5° boom angle (no load)	100 ft		100 ft	

A6-829-102575

NOTES:

1. All capacities above the bold line are based on structural strength of boom extension and do not exceed 85% of tipping loads, in accordance with SAE J-765.
2. 36 ft boom extension length may be used for single or double line lifting service. 59 ft boom extension may be used for single line lifting service only.
WARNING: Lifting with the 36 ft extension base, with the 23 ft extension fly either erected or folded along side of extension base, is strictly prohibited.
3. Capacities are applicable for a 160 ft main boom length only.
WARNING: Operation of this machine with heavier loads than the capacities listed is strictly prohibited. Machine tipping with boom extension occurs rapidly and without advance warning.
4. The loads for luffing depend on the angle of the main boom, angle of the boom extension and dynamic working pressure of the luffing cylinder for the boom extension.
5. Capacities listed are with outriggers properly extended and vertical jacks set only.

THIS CHART IS ONLY A GUIDE AND SHOULD NOT BE USED TO OPERATE THE CRANE.

The individual crane's load chart, operating instructions and other instructional plates must be read and understood prior to operating the crane

Load chart

59 ft luffing folding boom extension with 1 or 2 inserts 160 ft main boom (load luffing)

Feet	Pounds			
	59 ft LENGTH with 26 ft INSERT		59 ft LENGTH with 52 ft INSERT	
	5° - 20° OFFSET	20° - 40° OFFSET	5° - 20° OFFSET	20° - 40° OFFSET
80	6610			
85	6610			
90	6610		4230	
95	6610	4420	4230	
100	6610	4330	4230	
105	6610	4250	4230	4000
110	6430	4180	4230	4000
115	6250	4100	4230	4000
120	6070	4020	4230	4000
125	5900	3970	4230	4000
130	5480	3920	4230	4000
135	4930	3870	4110	4000
140	4380	3810	3820	3960
145	3900	3770	3350	3780
150	3420	3730	2880	3570
155	3000	3680	2470	3200
160	2580	3230	2060	2800
165	2210	2820	1690	2400
170	1840	2420		2010
175	1510	2060		1650
180		1700		
Min. boom angle for indicated length (no load)	46°	48°	56°	56°
Max. boom length (ft) at 5° boom angle (no load)	57 ft		57 ft	

A6-829-102579

NOTES:

- All capacities above the bold line are based on structural strength of boom extension and do not exceed 85% of tipping loads, in accordance with SAE J-765.
- 59 ft boom extension may be used for single line lifting service only.
WARNING: Lifting with the 36 ft extension base, with either one or two 26 ft insert sections installed is not permitted.
- Capacities are applicable for a 160 ft main boom length only.
WARNING: Operation of this machine with heavier loads than the capacities listed is strictly prohibited. Machine tipping with boom extension occurs rapidly and without advance warning.
- The loads for luffing depend on the angle of the main boom, angle of the boom extension and dynamic working pressure of the luffing cylinder for the boom extension.
- Capacities listed are with outriggers properly extended and vertical jacks set only.

THIS CHART IS ONLY A GUIDE AND SHOULD NOT BE USED TO OPERATE THE CRANE.

The individual crane's load chart, operating instructions and other instructional plates must be read and understood prior to operating the crane

Load chart

Installation and removal of counterweight and auxiliary hoist rated lifting capacities in pounds

On outriggers fully extended- 360°	
Radius in feet	Main boom length 42 ft*
10	65,000
12	65,000
15	65,000
20	65,000
25	65,000
30	57,000

Installation and removal of front and rear outrigger boxes rated lifting capacities in pounds without counterweight

On rubber (stationary) - 360°	
Radius in feet	Main boom length 42 ft*
10	15,000
12	15,000
15	15,000
20	12,350

* The boom must be fully retracted.

Notes for on rubber

- Capacities are applicable to machines equipped with Titan 33.25 x 29 (38 ply) tires at 85 psi cold inflation pressure Capacities do not exceed 75% of tipping loads as determined by test in accordance with SAE J765.
- With no load, the boom angle must not be less than 35° when over sides of machine since loss of stability will occur causing a tipping condition. To lower boom below 35° boom angle, boom must be swung over front or rear and LMI bypass activated.
- Once one outrigger box is installed, do not swing load over that end of the machine while installing the other outrigger box.
- Each outrigger box assembly weighs 9427 lb including the outrigger beams and pads.
- May be used for single or double line lifting service.

*THIS CHART IS ONLY A GUIDE AND SHOULD NOT BE USED TO OPERATE THE CRANE.
The individual crane's load chart, operating instructions and other instructional plates must be read and understood prior to operating the crane*

Load handling

Weight reductions for load handling devices	
36 ft - 59 ft manual boom extension	Pounds
*36 ft extension (erected)	5260
*59 ft extension (erected)	9860
Manual extension with 26 ft insert	Pounds
*59 ft extension (erected)	14,100
Manual extension with 52 ft insert	Pounds
*59 ft extension (erected)	19,400

*Reduction of main boom capacities (no deduct required for stowed boom extension. (no deduct required for stowed boom extension)
When lifting over boom nose with 36 ft or 59 ft extension erected, the outriggers must be fully extended or 50% extended (19 ft 9 in) spread.
When lifting over main boom nose with 26 ft or 52 ft insert erected, the outriggers must be fully extended.

Auxiliary boom nose	Pounds
	120
Hook blocks and headache balls	Pounds
134 USt, 8-sheave	2513+
83 USt, 5-sheave	1592+
50 USt, 3-sheave	992+
29 USt, single sheave	712+
12 USt, overhaul weight	648+
10 USt, overhaul ball	727+

+Refer to rating plate for actual weight.
When lifting over swingaway and/or jib combinations, deduct total weight of all load handling devices reeved over main boom nose directly from swingaway or jib capacity.
NOTE: All load handling devices and boom attachments are considered part of the load and suitable allowances **MUST BE MADE** for their combined weights. Weights are for Grove furnished equipment.

Capacity reductions for synthetic rope use		
	Main boom charts	Extension charts
Outriggers fully extended	200 lb	0 lb
Outriggers 50% extended	1130 lb	410 lb
Outriggers 0% extended	1740 lb	N/A
Rubber	460 lb	N/A

If synthetic rope is installed on either the main or auxiliary hoist, and wire rope is installed on the other hoist, no capacity reductions are required.

Line pulls and reeving information			
Hoists	Cable specs	Permissible line pulls	Nominal cable length
Main	19 mm (3/4 in) 35 x 7 Class Rotation resistant (non-rotating) Min. breaking strength 85,500 lb	16,800 lb*	950 ft
Main	22 mm K™-100 Synthetic hoist rope (ISO) Min. breaking strength 84,000 lb	16,800 lb*	971 ft
Auxiliary	19 mm (3/4 in) 35 x 7 Class Rotation resistant (non-rotating) Min. breaking strength 85,500 lb	16,800 lb*	700 ft
Auxiliary	22 mm K™-100 synthetic hoist rope (ISO) Min. breaking strength 84,000 lb	16,800 lb*	722 ft

The approximate weight of 3/4 in wire rope is 1.5 lb/ft.

The approximate weight of 22 mm synthetic is 0.21 lb/ft.

*With certain boom and hoist tackle combinations, the allowable line pull may be limited by hoist performance. Refer to Hoist Performance table for lift planning to ensure adequate hoist performance on drum rope layer required.

Hoist performance				
Wire rope layer	Hoist line pulls two-speed hoist		Drum rope capacity (ft)	
	Low available lb*	High available lb*	Layer	Total
1	19,267	11,094	136	136
2	17,709	10,197	148	285
3	16,384	9434	160	445
4	15,243	8777	172	618
5	14,251	8206	184	802
6	13,380	7705	196	998

*Max lifting capacity: 35 x 7 class = 16,800 lb

Note: Synthetic rope layer height may vary and may reduce available line pull per layer.

Working area diagram

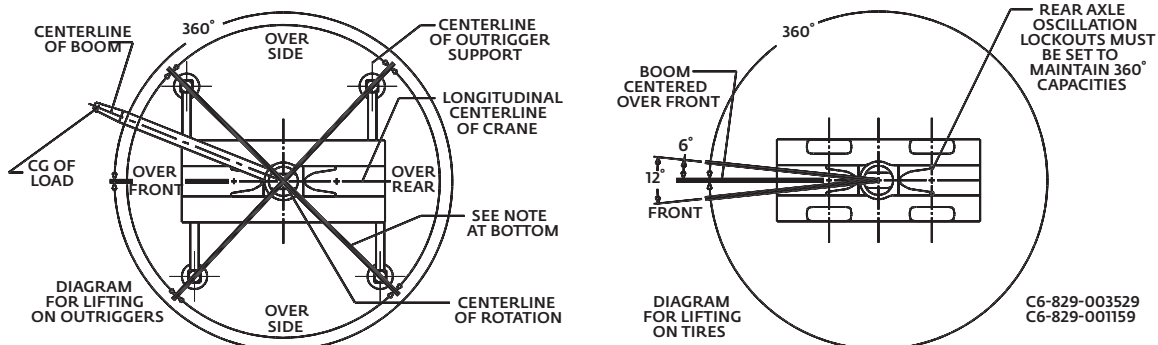

Bold lines determine the limiting position of any load for operation within working areas indicated.

THIS CHART IS ONLY A GUIDE AND SHOULD NOT BE USED TO OPERATE THE CRANE.

The individual crane's load chart, operating instructions and other instructional plates must be read and understood prior to operating the crane

Specifications

Superstructure



Boom

12,8 m - 48,8 m (42 ft - 160 ft) five-section, sequenced synchronized full power boom. Maximum tip height: 51,5 m (169 ft)



Lattice extension

11 m - 18 m (36 ft - 59 ft) offsettable bifold lattice swingaway extension. Offsets 0°, 20° and 40°. Stows alongside base boom section. Maximum tip height: 69,2 m (227 ft)



*Optional lattice extension

11 m - 18 m (36 ft - 59 ft) hydraulically offsettable bifold lattice swingaway extension. Offsets from 0° to 40°. Stows alongside base boom section. Maximum tip height: 69,2 m (227 ft)



*Optional lattice extension inserts

Two 8 m (26 ft) lattice extension inserts. Installs between the boom nose and bifold extension, nonstowable. Maximum tip height: 85 m (279 ft)



Boom nose

Seven nylonron sheaves mounted on heavy duty tapered roller bearings with removable pin-type rope guards. Quick reeving type boom nose. Removable auxiliary boom nose with removable pin type rope guard.



Boom elevation

One double acting hydraulic cylinder with integral holding valve provides elevation from -3° to 78°.



Load moment and anti-two block system

Standard "Graphic Display" load moment and anti-two block system with audio-visual warning and control lever lockout. These systems provide electronic display of boom angle, length, radius, tip height, relative load moment, maximum permissible load, load indication and warning of impending two-block condition. The standard Work Area Definition System allows the operator to pre-select and define safe working areas. If the crane approaches the pre-set limits, audio-visual warnings aid the operator in avoiding job-site obstructions.



Counterweight

18 144 kg (40,000 lb) of total counterweight. Hydraulically installed and removed.



Cab

20° tilt, full-vision, all-steel fabricated with acoustical lining and tinted safety glass throughout. Deluxe seat incorporates armrest-mounted hydraulic single-axis controllers. Tilt/telescoping steering wheel with various controls incorporated into the steering column. Other standard features include: hot water heater, cab circulating air fan, sliding side and rear windows, sliding skylight with electric wiper and sunscreen, electric windshield wash/wipe, fire extinguisher, seat belt, air conditioning, and dual cab mounted work lights.



Swing

Two speed, (2) planetary swing drives with foot applied multi-disc wet brakes. Spring applied, hydraulically released swing brakes. 360° positive swing lock and two-position mechanical house lock, both operated from cab. Maximum speed: 2.5 rpm



Hydraulic system

Six main pumps with a combined capacity of 776 LPM (205 GPM).

Maximum operating pressure: 331 bar (4800 psi).

Two individual post pressure compensated valve banks. Return line type filter with full flow by-pass protection and service indicator. Replaceable cartridge with micron filtration rating of 19/17/14.

1230 L (325 gal) reservoir. Remote mounted oil cooler with thermostatically controlled hydraulic driven motor, fan/air to oil. System pressure test ports.



Hoist (main and auxiliary hoist)

Planetary reduction with automatic spring applied multi-disc brake. Grooved drum electronic hoist drum rotation indicator, and hoist drum cable followers.

Maximum hoist single line pull:

1st layer - 8740 kg (19,267 lb)

3rd layer - 7432 kg (16,384 lb)

5th layer - 6464 kg (14,251 lb)

Maximum permissible single line pull:

7620 kg (16,800 lb) with 35 x 7 class rope

Maximum single line speed: 171 m/min (562 fpm)

Rope class:

35 x 7 EIPS WSC, Rotation Resistant

Rope diameter: 19 mm (3/4 in)

Rope length:

Main hoist - 290 m (950 ft)

Auxiliary hoist - 214 m (702 ft.)

Maximum rope stowage: 368 m (1206 ft)

* Denotes optional equipment

Specifications

Carrier



Chassis

Box section frame fabricated from high-strength, low alloy steel. Removable outrigger housings, front/rear towing and tie down lugs.



Outrigger system

Four hydraulic telescoping single-stage double box beam outriggers with inverted jacks and integral holding valves. Three position settings, 0%, 50% and fully extended. Outrigger boxes removable for ease of transportation. All steel fabricated, quick release type outrigger floats, 775 mm (30.5 in) diameter. Maximum outrigger pad load - 75 298 kg (166,000 lb). Outrigger Monitoring System comes standard (required for North America, Canada and the European Union).



Outrigger controls

Controls and crane level indicator located in cab.



Engine (Tier 4F)

Cummins QSL8.9L diesel, six cylinder, turbo-charged with Cummins Compact Catalyst (CCC) and Selective Catalytic Reduction (SCR) combo muffler, using Diesel Exhaust Fluid (DEF) injection. Meets emission per U.S. Tier 4F and E.U. Stage IV. 239 kW (320 bhp) gross at 2200 rpm. Maximum torque: 1383 Nm (1020 ft lb) at 1500 rpm. Fuel requirements: Maximum of 15 PPM sulphur content (Ultra low diesel fuel) and diesel exhaust fluid (DEF).

NOTE: Tier 4F engine required in North American and European Union countries.



Engine (Tier 3)

Cummins QSC8.3L diesel, six cylinders, 224 kW (300 bhp) (Gross) at 2200 rpm. Maximum torque: 1356 Nm (1000 ft lb) at 1600 rpm.

NOTE: Required for sale outside of N.A. and European Union.



Fuel tank capacity

379 L (100 gal)



Transmission

Full powershift with 6 forward and 3 reverse speeds. Front axle disconnect for 4 x 2 travel.



Axles

Cab controlled cross axle differential locks, (front and rear)

Front: Drive/steer with differential and planetary reduction hubs rigid mounted to frame.

Rear: Drive/steer with differential and planetary reduction hubs pivot mounted to frame.



Brakes

Full hydraulic split circuit, dry disc service brakes operating on all wheels. Spring-applied, hydraulically released parking brake mounted on front axle.



Steering

Fully independent power steering:

Front: Full hydraulic steering wheel controlled.

Rear: Full hydraulic switch controlled.

Provides infinite variations of four main steering modes: front only, rear only, crab and coordinated. Rear steer centered indicator light.



Tires

Standard 33.25 x 29 - 38 bias ply.



Electrical system

Three 12 V - maintenance free batteries. 12 V starting and lighting, circuit breakers.



Lighting

Full lighting including turn indicators, head, tail, brake and hazard warning lights.



Maximum Drive Speed

24 km/h (15 mph)



Gradeability (theoretical)

73% (Based on 79 913 kg [176,175 lb] GVW) 33.25 x 29 tires, pumps engaged, 48,8 m (160 ft) boom, plus 18 m (59 ft) swingaway, 18 144 kg (40,000 lb) counterweight, hook block and headache ball.

Miscellaneous standard equipment

Full width aluminum fenders, full length aluminum decking, dual rear view mirrors, hook block tie down, electronic back-up alarm, light package, front stowage well, tachometer/hourmeter, immersion type block heater, rear wheel position indicator, hot water cab heater, air conditioning, hoist mirrors, engine distress A/V warning system, front/rear tie down and tow lugs, coolant sight level indicator, hydraulic pump disconnect, LMI light bar. Hydraulically activated boom removal pins, lift cylinder travel support.

*Optional equipment

- **AUXILIARY LIGHTING AND CONVENIENCE PACKAGE:** Includes superstructure mounted amber flashing light, dual base boom mounted floodlights, and rubber mat for stowage trough.
- Rear pintle hook
- Wind speed indicator (wireless)
- Third wrap indicator with hoist cut-out (main and auxiliary)
- -29°C/-20°F Cold Weather Package
- -40°C/-40°F Arctic Package
- Synthetic rope for main and/or auxiliary hoist
- Vertical L.M.I. light tower
- Auxiliary hydraulic oil cooler
- CraneSTAR asset management system

** Denotes optional equipment*

Symbols glossary



Axles



Crane control system



Heavy duty jib



Outriggers



Boom



Drive



Height (no max)



Radius



Boom elevation



Electrical system



Hoist



Rotation



Boom extension



Engine



Hook block



Speed



Boom length



Extension



Hydraulic system



Steering



Boom nose



Frame



Insert



Suspension



Brakes



Fuel tank capacity



Lights



Swing



Cab



Gear



Oil



Tires



Counterweight



Grade



Outrigger controls



Transmission

Manitowoc Cranes

Regional headquarters

Americas

Milwaukee, Wisconsin, USA
Tel: +1 414 760 4600

Shady Grove, Pennsylvania, USA
Tel: +1 717 597 8121

Europe and Africa

Dardilly, France - TOWERS
Tel: +33 (0) 4 72 18 20 20

Wilhelmshaven, Germany - MOBILE
Tel: +49 (0) 4421 294 0

APAC

Shanghai, China
Tel: +86 21 6457 0066

Singapore
Tel: +65 6264 1188

Middle East and India

Dubai, UAE
Tel: +971 4 8862677

This document is non-contractual. Constant improvement and engineering progress make it necessary that we reserve the right to make specification, equipment, and price changes without notice. Illustrations shown may include optional equipment and accessories and may not include all standard equipment.