

GRT655/GRT655L

Product guide

ASME B30.5
Imperial 85%



Features

- 51 t (55 Ust) capacity
- **GRT655**: 10,6 m - 34,8 m (34.9 ft - 114.3 ft) four-section full-power boom
- **GRT655L**: 10,8 m - 43,0 m (35.3 ft - 141.2 ft) five-section full-power boom
- 7,92 m - 13,7 m (26 ft - 45 ft) manual offsettable telescopic swingaway extension
- Intuitive, user friendly controls with electronic joysticks and operator customizable function speeds
- Full vision cab with 20° tilt

GROVE GRT655/GRT655L

The GRT655/GRT655L was designed after gathering feedback from crane owners and operators to ensure that it is loaded with the features and reliability you demand.

Features

> Tilt cab

The tilt cab is designed with operator comfort and productivity in mind. Offering a full-vision design and 20° tilt for improved viewing at high boom angles. The tilt/telescoping steering wheel can also be positioned for optimum use.



> Crane Control system

The Crane Control System (CCS) offers a user-friendly interface, two full graphic displays mounted vertically for easier viewing and a jog dial for easier navigation and data input. The system allows the electronic controllers to be reprogrammed by the operator for specific speed and reaction. Parts commonality across Grove, Manitowoc and Potain product lines enhances operator familiarization and serviceability.



> Boom

Two boom options provide you with the versatility you demand. The GRT655 comes equipped with a 10,6 m - 34,8 m (34.9 ft - 114.3 ft) four-section, full-power boom. The GRT655L is equipped with a 10,8 m - 43,0 m (35.3 ft - 141.2 ft) five-section, full-power boom. Optional 7,92 m - 13,7 m (26 ft - 45 ft) manual offsettable telescopic swingaway extension adds to your lifting capabilities.



> Backing up our promise

We stand behind our new line of GRT cranes, and we are willing to prove it. With new three-, four- or five-year extended warranty programs as well as a new two-year standard warranty; our GRT line of cranes are built to be GROVE REAL TOUGH.

**THE ONLY FIVE-YEAR
WARRANTY PROGRAM
AVAILABLE IN THE INDUSTRY**

GRT655/GRT655L benefits

- > Higher nominal capacity and stronger load charts ensure higher rental rates
- > Industry-leading boom tip height and reach provide higher utilization and greater versatility
- > Innovative smart sensing outrigger position monitoring
- > Improved air conditioning and heating for the world market



Manitowoc Crane Care when you need it.
The assurance of the world's most advanced crane service and support to get you back to work fast.



Manitowoc Finance helps you get right to work generating profits for your business.
Financial tools that help you capitalize on opportunity with solutions that fit your needs.

Contents

- Dimensions 5
- Weights 7
- Working range - GRT655..... 9
- Load charts - GRT655 8
- Working range - GRT655L..... 12
- Load charts - GRT655L..... 13
- Load handling 16
- Specifications..... 17
- Symbols glossary..... 19

Dimensions GRT655

Standard tire size: 23.5 x 25												
Two-Wheel Steer	A	B	C	D	E	F	G	H	J	K	L	M
	13 927 mm (548")	13 450 mm (530")	11 125 mm (438")	10 459 mm (412")	10 161 mm (400")	7864 mm (310")	6623 mm (261")	2464 mm (97")	25°	21°	3079 mm (121")	7564 mm (298")
Four-Wheel Steer	A	B	C	D	E	F	G	H	J	K	L	M
	10 210 mm (402")	9860 mm (388")	7082 mm (279")	6435 mm (253")	6140 mm (242")	3813 mm (150")	3513 mm (138")	2464 mm (97")	25°	21°	3079 mm (121")	3514 mm (138")
Narrow tire size: 18.0 x 25												
Two-Wheel Steer	A	B	C	D	E	F	G	H	J	K	L	M
	13 928 mm (548")	13 450 mm (530")	11 125 mm (438")	10 386 mm (409")	10 138 mm (399")	7888 mm (311")	6688 mm (263")	2439 mm (96")	19°	19°	2938 mm (116")	7577 mm (298")
Four-Wheel Steer	A	B	C	D	E	F	G	H	J	K	L	M
	10 210 mm (402")	9860 mm (388")	7082 mm (279")	6362 mm (250")	6116 mm (241")	3837 mm (151")	3587 mm (141")	2439 mm (96")	19°	19°	2938 mm (116")	3526 mm (139")

Dimensions in mm (in) unless otherwise noted.

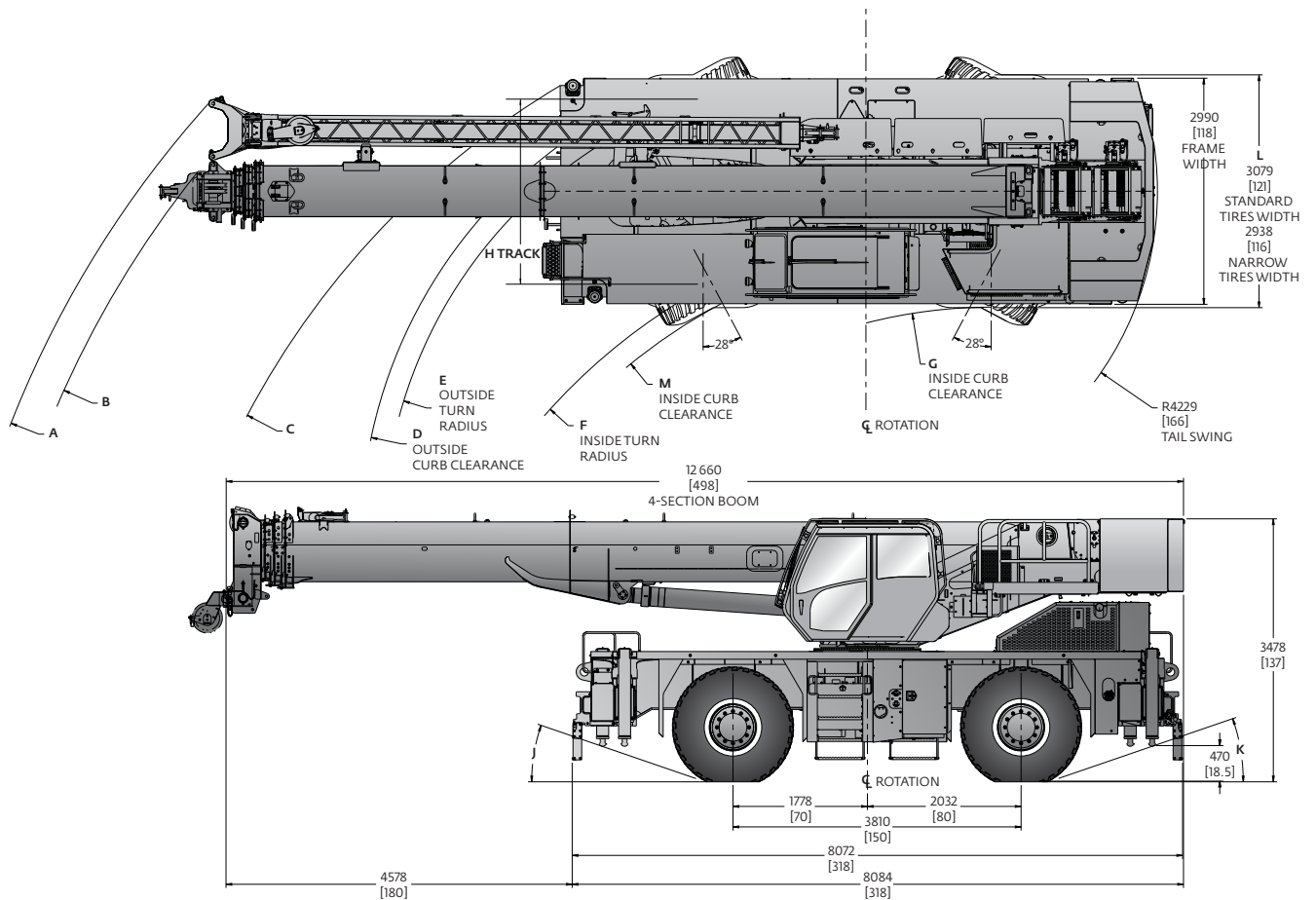

Dimensions

GRT655L

Standard tire size: 23.5 x 25

	A	B	C	D	E	F	G	H	J	K	L	M
Two-Wheel Steer	14 017 mm (552")	13 548 mm (533")	11 125 mm (438")	10 459 mm (412")	10 161 mm (400")	7864 mm (310")	6623 mm (261")	2464 mm (97")	25°	21°	3079 mm (121")	7564 mm (298")
Four-Wheel Steer	10 309 mm (406")	9969 mm (392")	7082 mm (279")	6435 mm (253")	6140 mm (242")	3813 mm (150")	3513 mm (138")	2464 mm (97")	25°	21°	3079 mm (121")	3514 mm (138")

Narrow tire size: 18.0 x 25

	A	B	C	D	E	F	G	H	J	K	L	M
Two-Wheel Steer	14 017 mm (552")	13 548 mm (533")	11 125 mm (438")	10 386 mm (409")	10 138 mm (399")	7888 mm (311")	6688 mm (263")	2439 mm (96")	19°	19°	2938 mm (116")	7577 mm (298")
Four-Wheel Steer	10 309 mm (406")	9969 mm (392")	7082 mm (279")	6362 mm (250")	6116 mm (241")	3837 mm (151")	3587 mm (141")	2439 mm (96")	19°	19°	2938 mm (116")	3526 mm (139")

Dimensions in mm (in) unless otherwise noted.

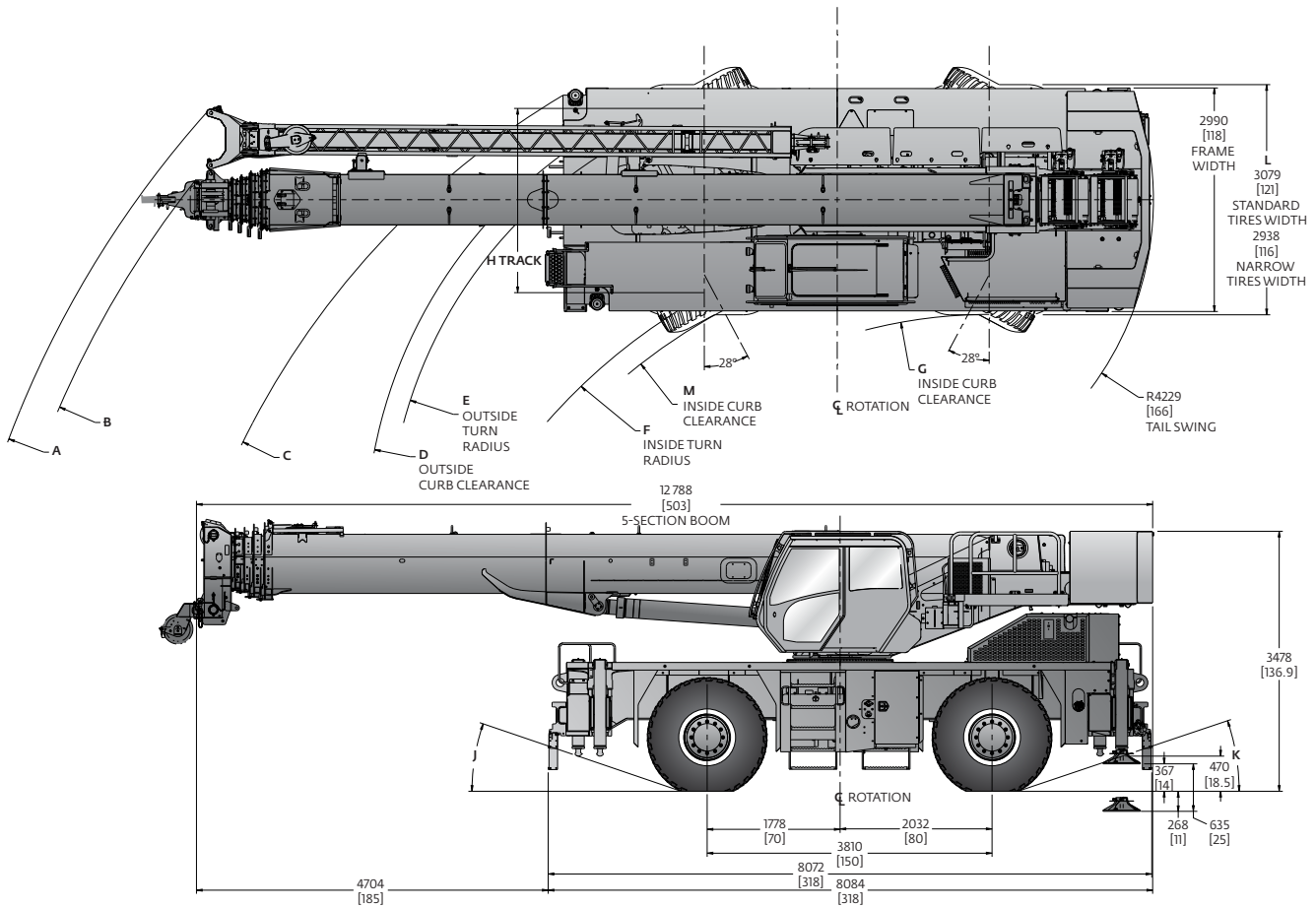

Dimensions and weights

GRT655 and GRT655L

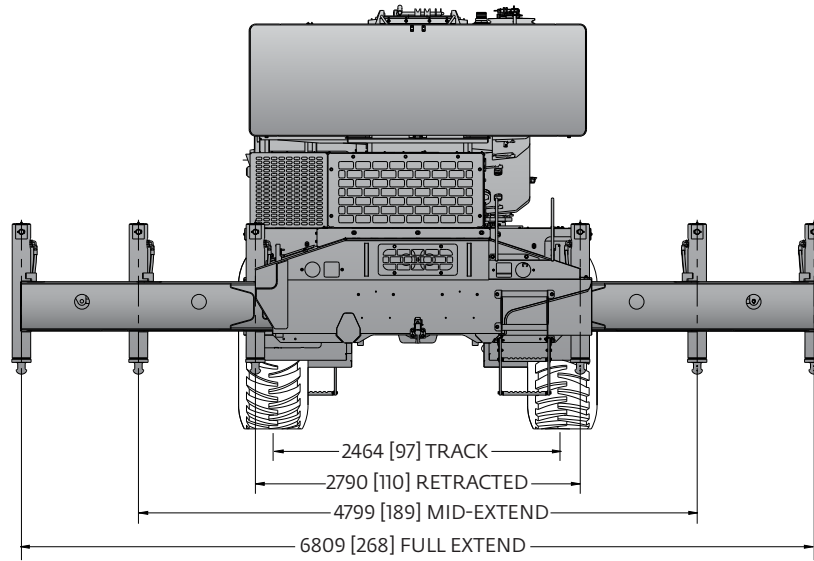

Weights - GRT655

	Gross		Front		Rear	
	kg	lb	kg	lb	kg	lb
Basic Machine: including four- section 34,8 m (114.3 ft) main boom, main hoist with 180 m (590 ft) of wire rope, IPO, full pinned counterweight, air conditioner, full aluminum decking, and hoist access platform and Tier 4F engine	32 779	72,263	13 787	30,395	18 991	41,868
Add: 51 t (56 USt) five-sheave hook block stowed in trough	425	937	439	968	-14	-31
crane weight	33 204	73,200	14 226	31,363	18 977	41,837
Add: 7 t (7.5 USt) headache ball	168	370	269	594	-101	-224
crane weight	33 372	73,570	14 495	31,957	18 876	41,613
Add: 7.92 m-13.7 m (26 ft -45 ft) telescopic swingaway + carrier brackets + aux. nose	978	2155	1778	3919	-800	-1764
crane weight	34 348	75,725	16 273	35,876	18 075	39,849
Add: Auxiliary Hoist + 180 m (590 ft) of wire rope ILO IPO	25	54	-4	-9	29	63
crane weight	34 373	75,779	16 269	35,868	18 103	39,911

Weights - GRT655L

	Gross		Front		Rear	
	kg	lb	kg	lb	kg	lb
Basic Machine: including five- section 43,0 m (141.2 ft) main boom, main hoist with 180 m (590 ft) of wire rope, IPO, full pinned counterweight, air conditioner, full aluminum decking, and hoist access platform and Tier 4F engine	33 058	72,880	15 138	33,372	17 921	39,508
Add: 51 t (56 USt) five-sheave hook block stowed in trough	425	937	439	968	-14	-31
crane weight	33 483	73,817	15 577	34,340	17 906	39,477
Add: 7 t (7.5 USt) headache ball	168	370	269	594	-101	-224
crane weight	33 651	74,187	15 846	34,934	17 806	39,253
Add: 7.92 m-13.7 m (26 ft -45 ft) telescopic swingaway + carrier brackets + aux. nose	978	2155	1778	3919	-800	-1764
crane weight	34 628	76,342	17 646	38,924	16 972	37,418
Add: Auxiliary Hoist + 180 m (590 ft) of wire rope ILO IPO	25	54	-4	-9	29	63
crane weight	34 653	76,396	17 652	38,916	17 001	37,480

Working range

GRT655

Working range diagram with bi-fold extension

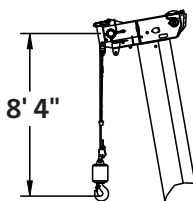
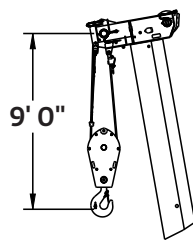
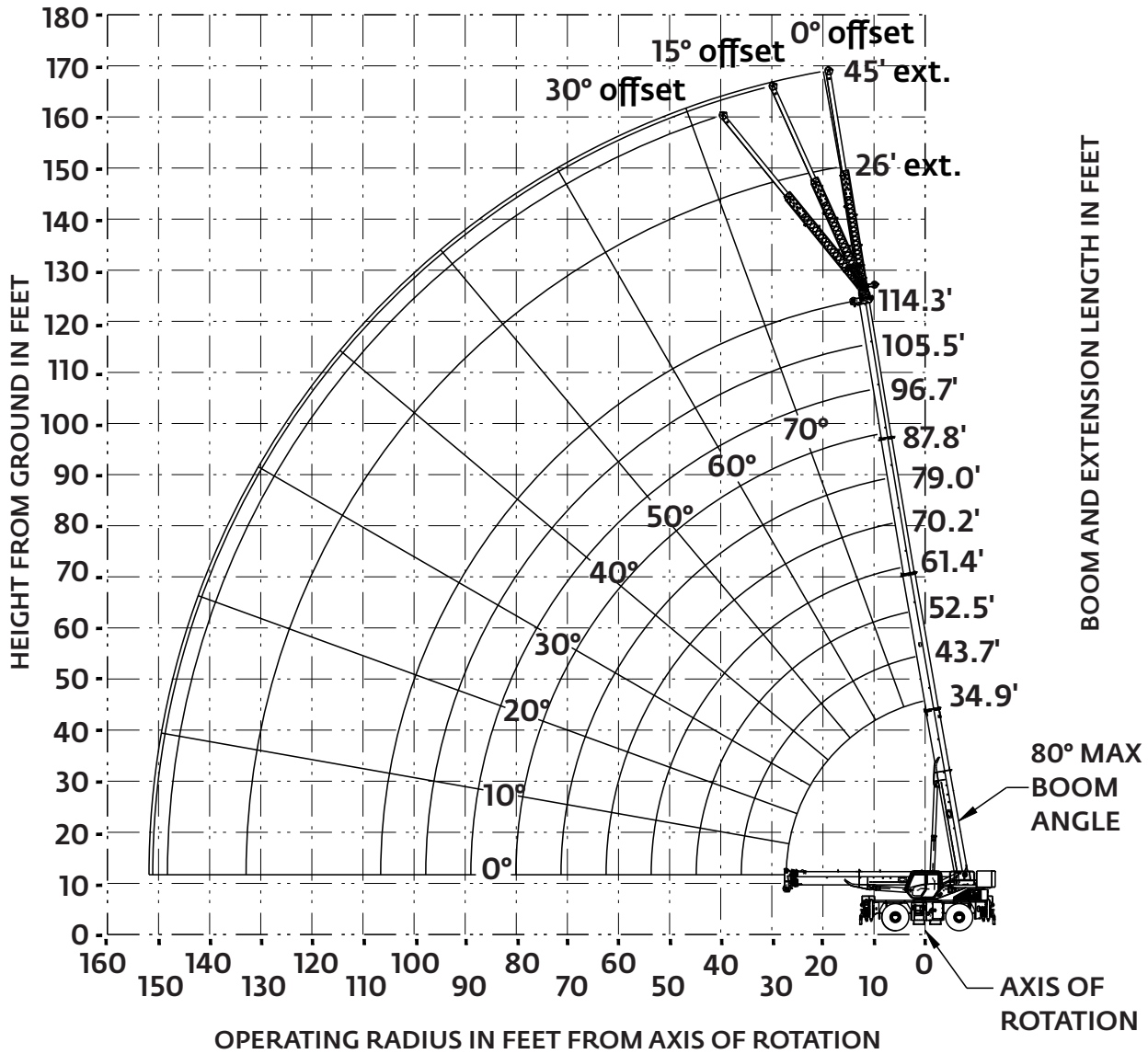

DIMENSIONS ARE FOR THE LARGEST GROVE FURNISHED HOOK BLOCK AND OVERHAUL BALL, WITH ANTI-TWO BLOCK ACTIVATED.

THIS CHART IS ONLY A GUIDE AND SHOULD NOT BE USED TO OPERATE THE CRANE.
The individual crane's load chart, operating instructions and other instructional plates must be read and understood prior to operating the crane

Load chart

GRT655



35 ft – 114 ft



12,300 lb



100%



360°



Pounds

Radius in Feet	Main Boom Length in Feet									
	34.9	43.7	52.5	61.4	70.2	79	87.8	96.7	105.5	114.3
8	110,000 (68.5)	—	—	—	—	—	—	—	—	—
10	88,750 (65)	81,000 (70.5)	79,700 (74)	79,200 (77)	72,650 (79.5)	—	—	—	—	—
12	80,150 (61)	78,100 (67.5)	76,400 (72)	75,050 (75)	68,200 (77.5)	*57,800 (80)	—	—	—	—
15	69,550 (55)	68,200 (63)	66,700 (68)	65,450 (72)	60,450 (75)	51,050 (77)	42,250 (79)	*34,500 (80)	—	—
20	55,300 (43)	55,800 (55.5)	54,900 (62)	53,900 (67)	49,400 (70.5)	42,050 (73)	34,950 (75.5)	33,300 (77)	28,100 (78.5)	*25,800 (80)
25	40,400 (26)	43,300 (46.5)	43,750 (55.5)	44,100 (61.5)	41,300 (66)	35,150 (69)	29,250 (72)	28,150 (74)	27,000 (76)	24,600 (77.5)
30	—	34,750 (35)	35,200 (48)	35,500 (56)	35,250 (61.5)	29,950 (65)	24,900 (68.5)	23,950 (71)	23,150 (73)	21,800 (75)
35	—	24,950 (17)	28,150 (39.5)	28,300 (50)	28,450 (56.5)	25,950 (61)	21,500 (64.5)	20,650 (67.5)	20,000 (70)	19,400 (72)
40	—	—	22,050 (29)	22,300 (43)	22,500 (51)	22,750 (56.5)	18,750 (61)	18,050 (64.5)	17,450 (67)	16,900 (69.5)
45	—	—	—	18,050 (34.5)	18,300 (45.5)	18,500 (52)	16,550 (57)	15,900 (61)	15,350 (64)	14,900 (66.5)
50	—	—	—	14,850 (24)	15,150 (38.5)	15,300 (47)	14,700 (53)	14,100 (57.5)	13,600 (61)	13,150 (64)
55	—	—	—	—	12,700 (30.5)	12,900 (41.5)	13,000 (48.5)	12,550 (53.5)	12,100 (57.5)	11,700 (61)
60	—	—	—	—	10,700 (19)	10,900 (35)	11,050 (43.5)	11,150 (49.5)	10,850 (54)	10,500 (58)
65	—	—	—	—	—	9300 (27)	9470 (38)	9560 (45)	9570 (50.5)	9420 (54.5)
70	—	—	—	—	—	7950 (14)	8100 (32)	8220 (40.5)	8240 (46.5)	8240 (51.5)
75	—	—	—	—	—	—	6950 (23.5)	7070 (35)	7120 (42.5)	7140 (48)
80	—	—	—	—	—	—	4650 (6.5)	6070 (29)	6150 (38)	6190 (44)
85	—	—	—	—	—	—	—	5210 (20.5)	5300 (32.5)	5370 (40)
90	—	—	—	—	—	—	—	—	4550 (26)	4640 (35.5)
95	—	—	—	—	—	—	—	—	3900 (17)	3990 (30)
100	—	—	—	—	—	—	—	—	—	3410 (23.5)
105	—	—	—	—	—	—	—	—	—	2890 (13.5)
Min. boom angle for indicated length (no load)										12°
Max. boom length at 0° boom angle (no load)										105.5 ft

NOTE: () Boom angles are in degrees.

*This capacity is based on maximum boom angle.

Boom Angle	Main Boom Length in Feet									
	34.9	43.7	52.5	61.4	70.2	79	87.8	96.7	105.5	114.3
0°	17,600 (27.1)	12,700 (35.9)	9480 (44.7)	7160 (53.6)	5420 (62.4)	4060 (71.2)	2970 (80)	2070 (88.9)	1320 (97.7)	—

NOTE: () Reference radii in feet.

80100630

THIS CHART IS ONLY A GUIDE AND SHOULD NOT BE USED TO OPERATE THE CRANE.
The individual crane's load chart, operating instructions and other instructional plates must be read and understood prior to operating the crane

Load chart

GRT655



114 ft



26 ft – 45 ft



12,300 lb



100%



360°



Pounds

Radius in Feet	26 ft Length			45 ft Length		
	0° Offset	15° Offset	30° Offset	0° Offset	15° Offset	30° Offset
20	*12,200 (80)	—	—	—	—	—
25	12,200 (79.5)	*9590 (80)	—	*8460 (80)	—	—
30	12,200 (77.5)	9000 (79)	*6710 (80)	7710 (79.5)	—	—
35	12,200 (75.5)	8490 (77.5)	6460 (79.5)	7060 (77.5)	*5120 (80)	—
40	11,950 (73.5)	8020 (75.5)	6230 (78)	6540 (76)	4890 (78.5)	—
45	10,950 (71.5)	7610 (73.5)	6030 (76)	6080 (74.5)	4670 (77)	*3750 (80)
50	10,100 (69.5)	7250 (71.5)	5840 (73.5)	5680 (72.5)	4470 (75)	3640 (79.5)
55	9410 (67.5)	6940 (69)	5670 (71.5)	5320 (70.5)	4290 (73.5)	3530 (77.5)
60	8800 (65.5)	6630 (67)	5520 (69.5)	5020 (69)	4130 (71.5)	3430 (76)
65	8270 (63)	6380 (65)	5380 (67)	4750 (67)	3980 (70)	3330 (74)
70	7790 (61)	6140 (62.5)	5250 (65)	4500 (65.5)	3840 (68)	3250 (72)
75	7140 (58.5)	5920 (60.5)	5130 (62.5)	4280 (63.5)	3720 (66)	3170 (70)
80	6160 (56)	5720 (58)	5020 (60)	4080 (61.5)	3600 (64)	3100 (68)
85	5320 (53.5)	5540 (55.5)	4930 (57)	3900 (59.5)	3480 (62)	3030 (65.5)
90	4580 (50.5)	4870 (53)	4850 (54.5)	3740 (57.5)	3370 (60)	2970 (63.5)
95	3930 (47.5)	4190 (50)	4370 (51)	3590 (55)	3280 (58)	2910 (61)
100	3360 (44.5)	3590 (46.5)	3730 (48)	3450 (53)	3180 (55.5)	2860 (58.5)
105	2840 (41)	3050 (43)	3160 (44.5)	3320 (50.5)	3100 (53)	2820 (56)
110	2380 (37.5)	2560 (39.5)	2650 (41)	3090 (48)	3020 (50.5)	2770 (53.5)
115	1960 (33.5)	2120 (35.5)	2190 (36.5)	2710 (45)	2950 (48)	2740 (50.5)
120	1580 (29)	1720 (31)	1770 (31.5)	2360 (42.5)	2740 (45)	2710 (47.5)
125	1240 (23.5)	1360 (25.5)	—	2040 (39)	2360 (42)	2480 (44)
130	—	1030 (17.5)	—	1750 (36)	2000 (38.5)	2090 (40.5)
135	—	—	—	1490 (32)	1680 (34.5)	1730 (36)
140	—	—	—	1240 (27.5)	1380 (30)	1410 (31)
145	—	—	—	1010 (22.5)	1110 (24.5)	—
Min. boom angle for indicated length (no load)	16°	16°	30°	21°	23°	30°
Max. boom length at 0° boom angle (no load)	79 ft			79 ft		

- 26 ft and 45 ft folding boom extension lengths may be used for single line lifting service.
- Radii listed are for a fully extended boom with the boom extension erected. For main boom lengths less than fully extended, the rated loads are determined by boom angle. Use only the column which corresponds to the boom extension length and offset for which the machine is configured. For boom angles not shown, use the rating of the next lower boom angle.
WARNING: Operation of this machine with heavier loads than the capacities listed is strictly prohibited. Machine tipping with boom extension occurs rapidly and without advance warning.
- Boom angle is the angle above or below horizontal of the longitudinal axis of the boom base section after lifting rated load.
- Capacities listed are with outriggers fully extended and vertical jacks set only.

NOTE: () Boom angles are in degrees.

*This capacity is based on maximum boom angle.

80100636

THIS CHART IS ONLY A GUIDE AND SHOULD NOT BE USED TO OPERATE THE CRANE.

The individual crane's load chart, operating instructions and other instructional plates must be read and understood prior to operating the crane

Load chart

GRT655

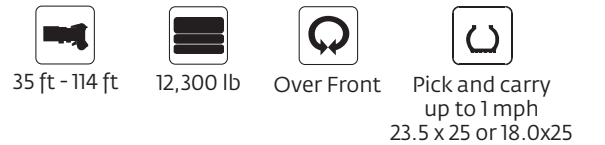

Radius in Feet	Main Boom Length in Feet			
	34.9	43.7	52.5	61.4
10	40,700 (65)	38,000 (70.5)	—	—
12	34,350 (61)	34,350 (67.5)	28,000 (72)	—
15	25,400 (55)	25,800 (63.5)	25,600 (68.5)	23,000 (72)
20	15,750 (43)	16,300 (55.5)	16,650 (62.5)	17,100 (67)
25	10,150 (26.5)	11,000 (47.5)	11,450 (56)	11,700 (62)
30	—	7600 (37)	8100 (49)	8260 (56)
35	—	5230 (19)	5710 (41)	5890 (50)
40	—	—	3940 (30)	4160 (43.5)
45	—	—	—	2840 (36)
50	—	—	—	1810 (25)
Min. boom angle for indicated length (no load)				0°
Max. boom length at 0° boom angle (no load)				61.4 ft

NOTE: () Boom angles are in degrees.

Boom Angle	Main Boom Length in Feet			
	34.9	43.7	52.5	61.4
0°	8460 (27.1)	4870 (35.9)	2620 (44.7)	1190 (53.6)

NOTE: () Reference radii in feet. 80100634

Radius in Feet	Main Boom Length in Feet			
	34.9	43.7	52.5	61.4
10	36,050 (65)	37,300 (70.5)	—	—
12	31,350 (61)	33,100 (67.5)	27,700 (72)	—
15	25,900 (55)	27,350 (63.5)	25,000 (68.5)	22,200 (72)
20	19,250 (43)	20,600 (55.5)	20,400 (62.5)	20,550 (67)
25	14,750 (26.5)	15,800 (47.5)	16,050 (56)	16,200 (62)
30	—	12,350 (37)	12,750 (49)	13,000 (56)
35	—	9700 (19)	10,250 (41)	10,500 (50)
40	—	—	8270 (30)	8550 (43.5)
45	—	—	—	6810 (36)
50	—	—	—	5340 (25)
Min. boom angle for indicated length (no load)				0°
Max. boom length at 0° boom angle (no load)				61.4 ft

NOTE: () Boom angles are in degrees.

Boom Angle	Main Boom Length in Feet			
	34.9	43.7	52.5	61.4
0°	13,250 (27.1)	9280 (35.9)	6530 (44.7)	4480 (53.6)

NOTE: () Reference radii in feet. 80100635

- Capacities are in pounds and do not exceed 75% of tipping loads as determined by test in accordance with SAE J765.
- Capacities are applicable to machines equipped with OTR DL-3 E-3/L-3 - 23.5x25 (24 ply) tires at 87 psi cold inflation pressure, or OTR CL735 E-3/L-3 - 18.0x25 (28 ply) at 83 psi cold inflation pressure.
- Capacities are applicable only with machine on firm level surface.
- On rubber lifting with boom extension not permitted.
- For pick and carry operation, boom must be centered over front of machine, mechanical swing lock engaged and load restrained from swinging.
- Axle lockouts must be functioning when lifting on rubber.
- All lifting depends on proper tire inflation, capacity and condition. Capacities must be reduced for lower tire inflation pressures. See lifting capacity chart for tire used. Damaged tires are hazardous to safe operation of crane.
- Creep - not over 200 ft of movement in any 30 minute period and not exceeding 1 mph.

THIS CHART IS ONLY A GUIDE AND SHOULD NOT BE USED TO OPERATE THE CRANE.
The individual crane's load chart, operating instructions and other instructional plates must be read and understood prior to operating the crane

Working range GRT655L

Working range diagram with bi-fold extension

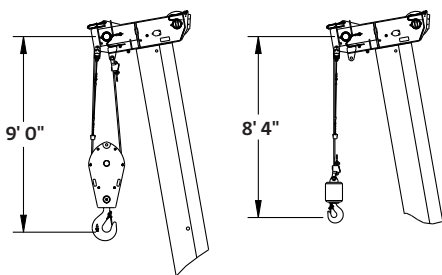
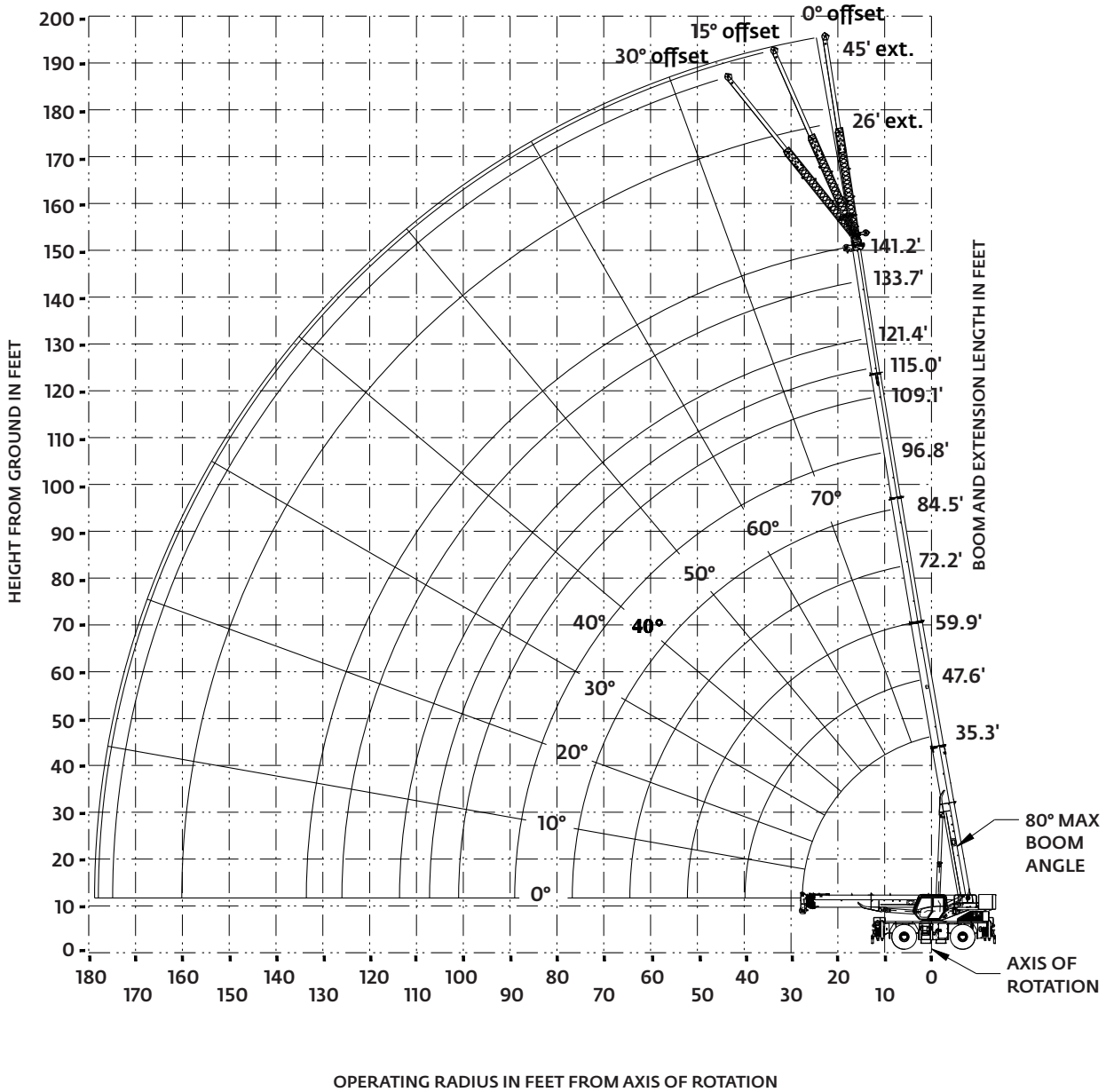

DIMENSIONS ARE FOR THE LARGEST GROVE FURNISHED HOOK BLOCK AND OVERHAUL BALL, WITH ANTI-TWO BLOCK ACTIVATED.

THIS CHART IS ONLY A GUIDE AND SHOULD NOT BE USED TO OPERATE THE CRANE. The individual crane's load chart, operating instructions and other instructional plates must be read and understood prior to operating the crane

Load chart

GRT655L



Pounds

Radius in Feet	Main Boom Length in Feet									
	35.3	47.6	59.9	72.2	84.5	96.8	109.1	121.4	133.7	141.2
8	110,000 (68.5)	—	—	—	—	—	—	—	—	—
10	87,750 (64.5)	44,200 (72)	42,600 (76)	41,300 (79)	—	—	—	—	—	—
12	79,150 (61)	44,200 (69.5)	42,600 (74)	41,300 (77)	—	—	—	—	—	—
15	68,650 (55)	44,200 (65.5)	42,600 (71)	41,300 (74.5)	39,700 (77)	*36,000 (80)	—	—	—	—
20	54,550 (43.5)	44,200 (58.5)	42,600 (65.5)	40,700 (70.5)	36,250 (73.5)	31,450 (76)	*27,950 (80)	*21,300 (80)	—	—
25	40,300 (27)	43,100 (50.5)	42,400 (60)	36,250 (66)	32,250 (70)	27,750 (73)	24,900 (75.5)	21,300 (77.5)	*18,100 (80)	—
30	—	34,450 (41.5)	35,000 (54.5)	32,750 (61.5)	29,050 (66)	24,650 (70)	22,350 (72.5)	20,250 (75)	18,100 (77)	15,700 (79.5)
35	—	27,300 (30)	28,350 (48)	28,850 (56.5)	26,450 (62.5)	22,150 (66.5)	19,650 (70)	18,450 (72.5)	16,850 (74.5)	15,700 (75.5)
40	—	—	22,200 (40.5)	22,650 (51.5)	23,150 (58.5)	20,100 (63.5)	17,100 (67)	16,450 (70)	15,500 (72.5)	14,700 (73.5)
45	—	—	17,800 (31.5)	18,300 (46)	18,750 (54)	17,900 (60)	15,000 (64)	14,450 (67.5)	14,000 (70)	13,600 (71.5)
50	—	—	14,500 (19)	15,050 (40)	15,450 (50)	15,600 (56.5)	13,300 (61)	12,750 (65)	12,350 (68)	12,150 (69.5)
55	—	—	—	12,500 (33)	12,950 (45)	13,100 (52.5)	11,800 (58)	11,350 (62.5)	10,950 (65.5)	10,800 (67)
60	—	—	—	10,450 (23.5)	10,950 (39.5)	11,100 (48.5)	10,550 (55)	10,100 (59.5)	9790 (63)	9620 (65)
65	—	—	—	—	9300 (33.5)	9470 (44.5)	9460 (51.5)	9060 (56.5)	8740 (60.5)	8580 (62.5)
70	—	—	—	—	7900 (26)	8110 (39.5)	8240 (48)	8120 (53.5)	7820 (58)	7670 (60.5)
75	—	—	—	—	6710 (14.5)	6930 (34.5)	7050 (44)	7230 (50.5)	7000 (55.5)	6860 (58)
80	—	—	—	—	—	5920 (28)	6080 (39.5)	6250 (47.5)	6280 (52.5)	6140 (55.5)
85	—	—	—	—	—	5050 (19.5)	5230 (35)	5410 (43.5)	5470 (49.5)	5500 (53)
90	—	—	—	—	—	—	4480 (29.5)	4670 (40)	4740 (46.5)	4780 (50)
95	—	—	—	—	—	—	3810 (23)	4000 (35.5)	4100 (43.5)	4140 (47)
100	—	—	—	—	—	—	3220 (12.5)	3400 (31)	3520 (40)	3580 (44)
105	—	—	—	—	—	—	—	2870 (25.5)	2980 (36)	3070 (41)
110	—	—	—	—	—	—	—	2390 (17.5)	2510 (32)	2600 (37.5)
115	—	—	—	—	—	—	—	—	2080 (27)	2170 (33.5)
120	—	—	—	—	—	—	—	—	1690 (21)	1790 (29)
Min. boom angle for indicated length (no load)							11°	16°	20°	28°
Max. boom length at 0° boom angle (no load)							96.8 ft			

NOTE: () Boom angles are in degrees.
 *This capacity is based on maximum boom angle.

Boom Angle	Main Boom Length in Feet									
	35.3	47.6	59.9	72.2	84.5	96.8	109.1	121.4	133.7	141.2
0°	16,350 (27.5)	10,350 (39.8)	6840 (52.1)	4500 (64.4)	2830 (76.7)	1590 (89)	—	—	—	—

NOTE: () Reference radii in feet. 80100637

THIS CHART IS ONLY A GUIDE AND SHOULD NOT BE USED TO OPERATE THE CRANE.

The individual crane's load chart, operating instructions and other instructional plates must be read and understood prior to operating the crane

Load chart

GRT655L



141 ft



26 ft – 45 ft



12,300 lb



100%



360°



Pounds

Radius in Feet	26 ft Length			45 ft Length		
	0° Offset	15° Offset	30° Offset	0° Offset	15° Offset	30° Offset
35	8610 (80)	—	—	—	—	—
40	8610 (77.5)	*8400 (80)	—	*6010 (80)	—	—
45	8610 (76)	7820 (78.5)	*6200 (80)	6010 (78.5)	—	—
50	8470 (74.5)	7280 (77)	6030 (78.5)	6010 (77)	4630 (80)	—
55	7860 (72.5)	6800 (75)	5870 (76.5)	5760 (75.5)	4460 (78)	—
60	7290 (71)	6360 (73)	5730 (75)	5460 (74)	4310 (76.5)	*3520 (80)
65	6780 (69.5)	5980 (71)	5440 (73)	5170 (72.5)	4170 (75)	3430 (78.5)
70	6330 (67.5)	5620 (69.5)	5160 (71)	4940 (71)	4040 (73.5)	3350 (76.5)
75	5930 (65.5)	5310 (67.5)	4900 (69)	4710 (69.5)	3920 (72)	3280 (75)
80	5570 (64)	5020 (65.5)	4660 (67)	4500 (68)	3810 (70.5)	3210 (73.5)
85	5240 (62)	4750 (63.5)	4440 (65)	4310 (66)	3700 (68.5)	3150 (71.5)
90	4890 (60)	4510 (61.5)	4230 (63)	4060 (64.5)	3600 (67)	3080 (70)
95	4200 (57.5)	4280 (59)	4050 (60.5)	3840 (63)	3440 (65)	3030 (68)
100	3530 (55.5)	3,890 (57)	3870 (58.5)	3640 (61)	3280 (63.5)	2980 (66.5)
105	2930 (53)	3240 (55)	3500 (56)	3450 (59)	3130 (61.5)	2930 (64.5)
110	2390 (50.5)	2660 (52.5)	2900 (53.5)	3270 (57)	2990 (59.5)	2820 (62.5)
115	1910 (48)	2140 (50)	2360 (51)	2810 (55)	2860 (57.5)	2710 (60)
120	1470 (45.5)	1660 (47.5)	1870 (48.5)	2300 (53)	2740 (55.5)	2610 (58)
125	1060 (43)	1230 (44.5)	1420 (45.5)	1830 (51)	2300 (53.5)	2310 (56)
130	—	—	1010 (42.5)	1400 (48.5)	1870 (51)	1940 (53.5)
135	—	—	—	1010 (46.5)	1480 (49)	1610 (51)
140	—	—	—	—	1120 (46.5)	1290 (48.5)
145	—	—	—	—	—	1010 (45.5)
Min. boom angle for indicated length (no load)	42°	43°	41°	45°	45°	44°
Max. boom length at 0° boom angle (no load)	72 ft			72 ft		

- 26 ft and 45 ft folding boom extension lengths may be used for single line lifting service.
- Radii listed are for a fully extended boom with the boom extension erected. For main boom lengths less than fully extended, the rated loads are determined by boom angle. Use only the column which corresponds to the boom extension length and offset for which the machine is configured. For boom angles not shown, use the rating of the next lower boom angle.
WARNING: Operation of this machine with heavier loads than the capacities listed is strictly prohibited. Machine tipping with boom extension occurs rapidly and without advance warning.
- Boom angle is the angle above or below horizontal of the longitudinal axis of the boom base section after lifting rated load.
- Capacities listed are with outriggers fully extended and vertical jacks set only.

NOTE: () Boom angles are in degrees.

*This capacity is based on maximum boom angle.

80100642

THIS CHART IS ONLY A GUIDE AND SHOULD NOT BE USED TO OPERATE THE CRANE.

The individual crane's load chart, operating instructions and other instructional plates must be read and understood prior to operating the crane

Load chart

GRT655L

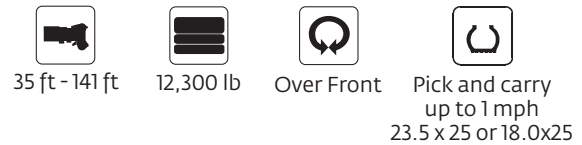

Radius in Feet	Main Boom Length in Feet			
	35.3	47.6	59.9	72.2
10	40,300 (64.5)	35,400 (71.5)	—	—
12	33,550 (61)	32,700 (69)	22,000 (73.5)	—
15	24,850 (54.5)	25,400 (65)	20,000 (70.5)	20,000 (74)
20	15,100 (44)	16,200 (58)	16,650 (65.5)	16,550 (70)
25	9800 (28.5)	10,950 (51)	11,350 (60)	11,350 (65.5)
30	—	7560 (42)	7980 (54.5)	8140 (61)
35	—	5170 (31)	5680 (48)	5880 (56.5)
40	—	—	4010 (41)	4250 (51.5)
45	—	—	2740 (32.5)	3020 (46)
50	—	—	1750 (19.5)	2050 (40.5)
55	—	—	—	1270 (33.5)
Min. boom angle for indicated length (no load)				32°
Max. boom length at 0° boom angle (no load)				59.9 ft

NOTE: () Boom angles are in degrees.

Boom Angle	Main Boom Length in Feet			
	35.3	47.6	59.9	72.2
0°	7940 (27.5)	3470 (39.8)	1390 (52.1)	—

NOTE: () Reference radii in feet. 80100640

Radius in Feet	Main Boom Length in Feet			
	35.3	47.6	59.9	72.2
10	30,500 (64.5)	30,500 (71.5)	—	—
12	26,450 (61)	24,000 (69)	21,500 (73.5)	—
15	21,800 (54.5)	20,700 (65)	19,600 (70.5)	19,400 (74)
20	17,750 (44)	18,800 (58)	17,700 (65.5)	17,400 (70)
25	13,650 (28.5)	15,150 (51)	15,700 (60)	15,400 (65.5)
30	—	11,750 (42)	12,400 (54.5)	13,400 (61)
35	—	9230 (31)	9870 (48)	10,850 (56.5)
40	—	—	7860 (41)	8640 (51.5)
45	—	—	6240 (32.5)	6860 (46)
50	—	—	4900 (19.5)	5390 (40.5)
55	—	—	—	4150 (33.5)
60	—	—	—	3110 (24)
Min. boom angle for indicated length (no load)				0°
Max. boom length at 0° boom angle (no load)				72.2 ft

NOTE: () Boom angles are in degrees.

Boom Angle	Main Boom Length in Feet			
	35.3	47.6	59.9	72.2
0°	12,000 (27.5)	7290 (39.8)	4410 (52.1)	2300 (64.4)

NOTE: () Reference radii in feet. 80100641

- Capacities are in pounds and do not exceed 75% of tipping loads as determined by test in accordance with SAE J765.
- Capacities are applicable to machines equipped with OTR DL-3 E-3/L-3 - 23.5x25 (24 ply) tires at 87 psi cold inflation pressure, or OTR CL735 E-3/L-3 - 18.0x25 (28 ply) at 83 psi cold inflation pressure.
- Capacities are applicable only with machine on firm level surface.
- On rubber lifting with boom extension not permitted.
- For pick and carry operation, boom must be centered over front of machine, mechanical swing lock engaged and load restrained from swinging.
- Axle lockouts must be functioning when lifting on rubber.
- All lifting depends on proper tire inflation, capacity and condition. Capacities must be reduced for lower tire inflation pressures. See lifting capacity chart for tire used. Damaged tires are hazardous to safe operation of crane.
- Creep - not over 200 ft of movement in any 30 minute period and not exceeding 1 mph.

*THIS CHART IS ONLY A GUIDE AND SHOULD NOT BE USED TO OPERATE THE CRANE.
The individual crane's load chart, operating instructions and other instructional plates must be read and understood prior to operating the crane*

Load handling

Weight reductions for load handling devices	
Auxiliary boom nose	45 kg (100 lb)
Hook blocks and overhaul weights:	
51 t (56 USt), 5-sheave	425 kg (937 lb+)
35 t (38 USt), 3 sheave	387 kg (853 lb +)
32 t (35 USt), 4-sheave	388 kg (855 lb+)
17 t (18.7 USt), 1-sheave	261 kg (575 lb+)
7.5 t (8.3 USt), overhaul weight	165 kg (364 lb +)
7 t (7.5 USt), overhaul ball	168 kg (370 lb +)
6 t (6.6 USt) overhaul ball	105 kg (231 lb+)

+Refer to rating plate for actual weight.

Tire inflation - PSI (bar)			
	Size (front and rear)	TRA Code	Lifting service, general travel and extended travel
			Static, creep
Standard	23.5 x 25 (24 ply)	E-3/L-3	87 (6)
Narrow	18.0 x 25 (28 ply)	E-3/L-3	83 (5.7)

Line pulls and reeving information			
Hoists	Cable Specs.	Permissible Line Pulls	Nominal Cable Length
Main and Auxiliary	16 mm (5/8 in) 35x7 Class EEIPS + Rotation Resistant Min. Breaking strength 27760 kg (61,200 lb)	5552 kg (12,240 lb)*	180 m (590 ft)
Main and Auxiliary	18 mm K100™ Hoist Rope Min. Breaking strength 28 895 kg (63,700 lb)	5780 kg (12,740 lb)*	185 m (606 ft)

The approximate weight of 16 mm (5/8 in) wire rope is 1,34 kg/m (0.90 lb/ft).

The approximate weight of 18 mm synthetic rope is 0,24 kg/m (0.16 lb/ft).

*With certain boom and hoist tackle combinations, the allowable line pull may be limited by hoist performance. Refer to Hoist Performance table for lift planning to ensure adequate hoist performance on drum rope layer required.

Telescopic boom extension			
		Without overhaul weight or block	With overhaul ball
		7,9 m - 13,7 m (26 ft - 45 ft)	*7,9 m (26 ft)
Telescopic boom extension	*13,7 m (45 ft)	1678 kg (3700 lb)	2540 kg (5600 lb)

*Reduction of main boom capacities (no deduct required for stowed boom extension)

NOTE: All load handling devices and boom attachments are considered part of the load and suitable allowances MUST BE MADE for their combined weights. Weights are for Grove furnished equipment.

NOTE: When operating at temperatures below -40°F, capacities shall be derated 3.6% of rated load for each degree Fahrenheit below -40°F without shock load.

Hoist performance				
Wire rope layer	Hoist line pulls		Drum capacity	
	Two speed hoist		Layer m (ft)	Total m (ft)
	Low Available kg (lb)	High Available kg (lb)		
1	7515 (16,568)	3372 (7435)	29 (95)	29 (95)
2	6828 (15,053)	3064 (6756)	31,7 (104)	60,7 (199)
3	6256 (13,792)	2808 (6190)	34,7 (114)	95,1 (312)
4	5772 (12,726)	2590 (5711)	37,5 (123)	132,6 (435)
5	5358 (11,813)	2404 (5301)	40,5 (133)	173,1 (568)
6	4999 (11,022)	2243 (4946)	43,3 (142)	216,4 (710)

*Refer to Line Pulls and Reeving Information table for max. lifting capacity of wire rope. Synthetic rope layer height may vary and may reduce available line pull per layer.

Working area diagram

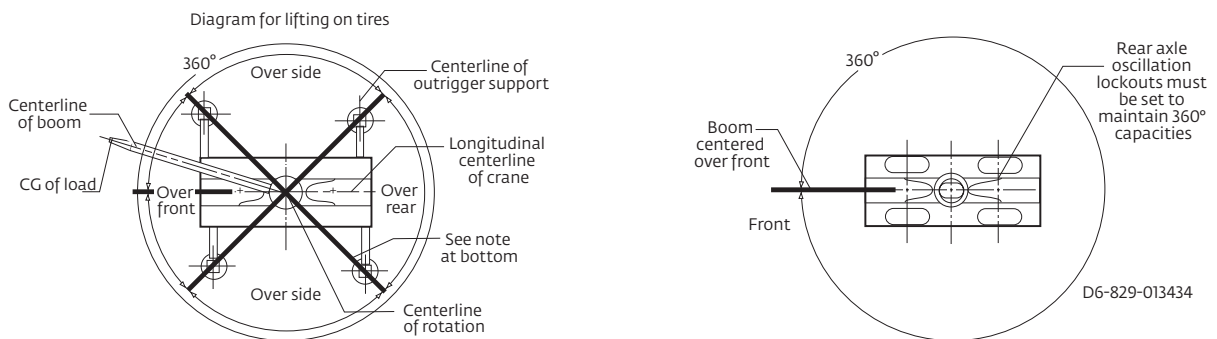

Bold lines determine the limiting position of any load for operation within working areas indicated.

Specifications

Superstructure



Boom (GRT655)

10,6 m - 34,8 m (34.9 ft - 114.3 ft) four-section, full-power boom.
Synchronized extension and retraction. Maximum tip height: 38,1 m (125 ft)



Boom (GRT655L)

10,8 m - 43,0 m (35.3 ft - 141.2 ft) five-section, full-power boom.
Synchronized extension and retraction. Maximum tip height: 46,0 m (151 ft)



*Optional manual swingaway extension

7,9 m - 13,7 m (26 ft - 45 ft) telescopic swingaway extension. Offsettable at 0°, 15°, and 30°. Stows alongside base boom section.
Maximum tip height (GRT655): 51,8 m (170 ft)
Maximum tip height (GRT655L): 59,7 m (196 ft)



Boom nose

Four nylatron sheaves mounted on heavy-duty tapered roller bearings with removable pin-type guards. Quick-reeve type boom nose. Removable single sheave auxiliary boom nose with removable pin type rope guard.



Boom elevation

One double – acting hydraulic cylinder with integral holding valve provides elevation from -3° to +80°.



Crane Control System (CCS)

“Graphic Display” RCL load moment and anti-two block system with audio-visual warning and control lever lockout. This system provides electronic display of boom angle, boom length, load radius, boom tip height, maximum permissible load, actual load and warning of impending two-block condition. The work area definition system allows the operator to pre-select and define safe working areas. If the crane approaches the pre-set limits, audio-visual warnings aid the operator in avoiding job site obstructions. ECO mode system to control engine R.P.M. to lower noise and improve fuel consumption. .



Counterweight

5579 kg (12,300 lb) one piece, pinned to superstructure.



Cab

Operator controlled 20° hydraulic tilt, Full vision, all steel fabricated with acoustical lining and tinted safety glass throughout. Deluxe seat with headrest incorporates armrest-mounted electronic programmable single-axis or dual axis controllers and a jog dial for easier data input. Tilt/telescoping steering wheel with various controls incorporated into the steering column. Other standard features include: hot water heater, cab circulating air fan, sliding side and opening rear window, sliding skylight with electric wiper and sunscreen, electric windshield wash/wipe, fire extinguisher, seat belt, air conditioning, and dual cab mounted work lights.



Swing

Variable speed, planetary swing drive with foot applied multi-disc proportional wet brake. Spring applied, hydraulically released swing brake. Two position mechanical swing lock pin, operated from cab. Maximum swing speed: 1.7 r.p.m.



Hoist (main and auxiliary hoist)

Planetary reduction driven by axial piston motor. Grooved drum with automatic spring applied multi-disk wet brake. Electronic hoist drum rotation indicator, and hoist drum cable follower.

Maximum hoist single line pull:

1st layer: 7515 kg (16,568 lb)

3rd layer: 6256 kg (13,792 lb)

5th layer: 5358 kg (11,813 lb)

Maximum permissible single line pull:

5552 kg (12,240 lb) with 35 x 7 class rope

Maximum hoist single line speed (no load):

148 m/min (487 ft/min)

Rope construction:

35 x 7 rotation – resistant

Rope diameter:

16 mm (5/8 in)

Rope length:

Main hoist: 180 m (590 ft)

Aux. hoist : 180 m (590 ft)

Maximum usable rope:

213 m (700 ft) 5 layers

** Denotes optional equipment*

Specifications

Carrier



Chassis

Parallel box section fabricated from high strength, low alloy steel with integral outrigger boxes, front and rear, tie-down, and towing lugs.



Outrigger system

Four hydraulic telescoping single stage double box beam outriggers with inverted jack cylinders and integral jack holding valves. Three position settings, 0%, 50%, and fully extended. Polymer outrigger floats 500 mm (19.6 in) diameter. Outrigger Monitoring System (OMS) with in-cylinder sensors. Outrigger beam position shown on RCL display. Maximum outrigger pad load: 34 110 kg (75,200 lb)



Outrigger controls

Controls and crane leveling indicator located in cab. Extension and retraction are thru the CCS system.



Hydraulic system

Two main pumps [1] variable displacement piston and [1] gear with a combined output capacity of 331 l/min (88 gal/min). Maximum operating pressure: 276 bar (4000 p.s.i.) Return line in-tank filter with full flow by-pass protection and service indicator. Replaceable cartridge with 4 micron filtration rating per ISO cleanliness level of 17/15/12. Superstructure mounted oil cooler with thermostatically controlled electric motor driven fan/air to oil. System pressure test ports.



Engine (Tier 4F)

Cummins QSB6.7L diesel six cylinder, turbo-charged with Cummins Compact Catalyst (CCC) and Selective Catalytic Reduction (SCR) combo muffler, using Diesel Exhaust Fluid (DEF) injection. Meets emissions per U.S. Tier 4F and E.U. stage IV. 164 H.P. (122 kW) at 2300 r.p.m., maximum torque: 540 lb/ft (732 Nm) at 1500 r.p.m. Fuel requirements: Maximum of 15 ppm "Ultra Low Sulfur Diesel Fuel" + diesel exhaust fluid (DEF).

NOTE: Required for sale in areas with maximum 15 ppm sulfur content diesel fuel or country requirement.



Engine (Tier 3)

Cummins QSB6.7L diesel six cylinder, turbo-charged with 160 H.P. (119 kW) at 2500 r.p.m., maximum torque : 540 lb/ft (732 Nm) at 1500 r.p.m. Fuel requirements: Maximum of 5000 ppm Sulfur Diesel fuel.

NOTE: Required for sale in areas with GREATER than 15 ppm sulfur content diesel fuel.



Fuel tank capacity

244 L (64.5 gal)



Transmission

Rangeshift with 6 forward and 6 reverse speeds. (3 speeds high and 3 speeds low). Front axle disconnect for 4 x 2 drive.



Axles

FRONT: Drive / steer with differential and planetary reduction hubs rigid mounted to frame.

REAR: Drive / steer with differential and planetary reduction hubs pivot mounted to frame. Automatic full hydraulic lockouts on rear axle permits 221 mm (8.7 in) of oscillation only with boom centered over the front.



Brakes

Full hydraulic split (dual) circuit dry disc operating on all wheels with dual calipers. Parking brake is spring applied/hydraulically released on the front axle input shaft.



Steering

Fully independent power steering.

Front: Fully hydraulic steering wheel controlled.

Rear: Fully hydraulic via separate momentary switch. Provides four steering modes, front only, rear only, coordinated, and crab. Rear steer not aligned indicator.

Outside 4ws coordinated steer radius:

23.5 x 25: 6,14 m (21.0 ft)

18.0 x 25: 6,09 m (20.8ft)

Inside 4ws coordinated steer radius:

23.5 x 25: 3,81 m (12.5 ft)

18.0 x 25: 3,83 m (12.5 ft)



Tires

23.5 x 25 – 24 Bias ply rating

18.0 x 25 – 28 Bias ply rating



Electrical system

Two 12V maintenance free batteries with disconnect. 24V system / 24V lighting



Lighting

Full lighting including turn indicators, head, tail, brake, and hazard warning, and two work lights mounted on cab front.



Maximum Drive Speed

30,3 kph (18.8 mph) with counterweight installed



Gradeability (theoretical)

75.2% to drive train stall based on 34 373 kg (75,779 lb) GVW with 23.5 x 25 tires, std. counterweight, aux. hoist, and manual bi-fold extension. Max. allowed fore/aft grade: 30% limited by engine. Refer to operators manual for additional information.

Miscellaneous standard equipment

























Full length aluminum fenders with full aluminum decking, dual rear view mirrors, hook block tie-down, electronic back-up alarm, front stowage tray, hot water cab heater/defroster, cab air conditioner, hoist mirrors, A/V warning system, combination tie-down/towing lugs, coolant sight level indicator, hoist access platform,

*Optional equipment

- Auxiliary Hoist Package: Includes GHP15 hoist with electronic hoist drum rotation indicator, hoist drum cable follower, 180 m (590 ft) of 16 mm (5/8 in) of 35 x 7 class rotation resistant wire rope.
- Auxiliary Lighting and Convenience Package: Includes superstructure mounted amber flashing light, dual base boom mounted floodlights, in-cab RCL light bar, and rubber mat for storage trough.
- 360° positive mechanical swing lock
- Rear Pintle Hitch
- Cab-controlled cross axle differential locks (front and rear)
- Wireless wind speed indicator
- Vertical external mounted RCL light tower
- -29°C / -20°F cold weather package
- -40°C / -40°F arctic weather package
- Emergency stop buttons on each side of carrier
- Second beacon light
- Refinery Package (certified spark arrestor + engine air shutdown available on T3 engine only)
- C.E. certificate package
- Russian certificate package
- Synthetic rope for main and/or auxiliary hoist
- Boom position indicator light
- Three-camera system (back-up, blind side, hoist)
- 270° view camera system
- Crane Star asset management system

* Denotes optional equipment

Symbols glossary

	Axles		Crane control system		Heavy duty jib		Outriggers
	Boom		Drive		Height (no max)		Radius
	Boom elevation		Electrical system		Hoist		Rotation
	Boom extension		Engine		Hook block		Speed
	Boom length		Extension		Hydraulic system		Steering
	Boom nose		Frame		Insert		Suspension
	Brakes		Fuel tank capacity		Lights		Swing
	Cab		Gear		Oil		Tires
	Counterweight		Grade		Outrigger controls		Transmission

Manitowoc Cranes

Regional headquarters

Americas

Milwaukee, Wisconsin, USA
Tel: +1 414 760 4600

Shady Grove, Pennsylvania, USA
Tel: +1 717 597 8121

Europe and Africa

Dardilly, France - TOWERS
Tel: +33 (0) 4 72 18 20 20

Wilhelmshaven, Germany - MOBILE
Tel: +49 (0) 4421 294 0

APAC

Shanghai, China
Tel: +86 21 6457 0066

Singapore
Tel: +65 6264 1188

Middle East and India

Dubai, UAE
Tel: +971 4 8862677



This document is non-contractual. Constant improvement and engineering progress make it necessary that we reserve the right to make specification, equipment, and price changes without notice. Illustrations shown may include optional equipment and accessories and may not include all standard equipment.