

Liftcrane Jib Capacities

Jib No. 134 on
Boom No. B10:82A
83 730 kg Crane Counterweight
19 960 kg Carbody Counterweight
Crawler Machine on a Barge
0 Degree thru 3 Degree Static Machine List
No Travel - 360 Degree Rating

MLC250 SERIES 2



LIFTING CAPACITIES: Chart supplements Boom Capacity chart **No. 9895-AM**. Lifting capacities are for a crawler machine when operating on a barge. Machine shall be positively secured to prevent shifting. Lifting capacities for various boom lengths, jib lengths, and jib operating radii are for freely suspended loads and may be based on percent of static tipping or strength of structural components. Capacities must be reduced by applicable deducts.

Weight of all load blocks, hooks, weight ball, slings, hoist lines, etc., beneath boom and jib point sheaves is considered part of load. Boom and jib are not to be lowered beyond radii where combined weights are greater than rated capacity. Where no capacity is shown, operation is not intended or approved.

OPERATING CONDITIONS: Machine to operate on a firm and uniformly supporting surface with gantry up and machine list not to exceed degrees noted. Refer to Boom Rigging **No. 80137888**, Jib Rigging **No. 80117860**, Wire Rope Specifications chart **No. 9916-A**, Counterweight Arrangements chart **No. 9893-A**, and Wind Conditions chart **No. 9917-A**. Crane operator judgment must be used to allow for dynamic load effects of swinging, hoisting or lowering, wind conditions, as well as adverse operating conditions and physical machine depreciation. Refer to the Operator Manual for operating guidelines.



OPERATING RADIUS: Operating radius is horizontal distance from axis of rotation at barge deck to center of vertical hoist line or load block.



BOOM ANGLE: Boom angle in degrees ($^{\circ}$) is angle between horizontal and centerline of boom butt and inserts, and is an indication of operating radius. In all cases, operating radius shall govern capacity.



JIB POINT ELEVATION: Jib point elevation is vertical distance from barge deck to centerline of jib point shaft.

MACHINE EQUIPMENT: Machine equipped with 8 585 mm crawlers, 1 200 mm or 1 524 mm treads, 3 124 mm retractable gantry, 9 144 mm live mast, 20 part boom hoist reeving, and boom support straps.

Refer to Tables 1 and 2 for raising ability with the maximum weight of all load blocks, hooks, weight ball, slings, and hoist lines beneath boom and jib point sheaves. For block weights shown with #, load blocks, hooks, weight ball, and slings must remain on barge deck until combined weights are within rated capacity of chart. Raising is not permitted in shaded areas of table.

Caution: Combined weight beneath boom and jib point sheaves must not exceed block weight shown. Total weight beneath jib point must not exceed 1 360 kg.

Table 1

Over End or Side of Crawlers													
Boom Length (m)	Maximum Number of Lower Boom Point Sheaves	Jib No. 134											
		9,1 m		12,2 m		15,2 m		18,3 m		21,3 m		24,4 m	
		Block Weight (kg)											
		0°	1° - 3°	0°	1° - 3°	0°	1° - 3°	0°	1° - 3°	0°	1° - 3°	0°	1° - 3°
27,4 - 42,7	8	5 875	5 875	5 875	5 875	5 875	5 875	5 875	5 875	5 875	5 700	4 850	4 625
45,7	8	5 875	5 875	5 875	5 875	5 875	5 875	5 875	5 475	5 250	4 800	4 800	4 375
48,8	8	5 875	5 875	5 875	5 575	5 650	5 075	5 150	4 650	4 475	4 075	4 125	3 650
51,8	8	5 700	5 125	5 200	4 650	4 750	4 250	4 350	3 850	4 025	3 525	3 400	2 975
54,9	8	4 800	4 200	4 350	3 850	3 975	3 475	3 575	3 125	3 300	2 850	2 750	2 350
57,9	8	3 700	3 300	3 350	2 975	3 025	2 625	2 675	2 250	2 350	1 975	1 975	1 625
61,0	8	2 675	2 300	2 350	1 975	1 975	1 625	1 625	#	1 350	#	#	#
64,0	8	1 675	#	1 350	#	#	#	#	#	#	#	#	#
67,1	8	#	#	#	#	#	#	#	#	#	#	#	#
70,1	8	#	#	#	#	#	#	#	#	#	#	#	#
73,2	8	#	#	#	#	#	#	#	#	#	#	#	#
76,2	2	Raising Not Permitted											
79,2	2	Raising Not Permitted											

Table 2

Over End of Blocked Crawlers													
Boom Length (m)	Maximum Number of Lower Boom Point Sheaves	Jib No. 134											
		9,1 m		12,2 m		15,2 m		18,3 m		21,3 m		24,4 m	
		Block Weight (kg)											
		0°	1° - 3°	0°	1° - 3°	0°	1° - 3°	0°	1° - 3°	0°	1° - 3°	0°	1° - 3°
27,4 - 42,7	8	5 875	5 875	5 875	5 875	5 875	5 875	5 875	5 875	5 875	5 700	4 850	4 625
45,7	8	5 875	5 875	5 875	5 875	5 875	5 875	5 875	5 475	5 250	4 800	4 800	4 375
48,8	8	5 875	5 875	5 875	5 575	5 650	5 075	5 150	4 650	4 475	4 075	4 125	3 650
51,8	8	5 700	5 125	5 200	4 650	4 750	4 250	4 350	3 850	4 025	3 525	3 400	2 975
54,9	8	4 800	4 200	4 350	3 850	3 975	3 475	3 575	3 125	3 300	2 850	2 750	2 350
57,9	8	3 850	3 350	3 475	2 975	3 125	2 675	2 800	2 350	2 575	2 175	2 250	1 850
61,0	8	3 075	2 575	2 750	2 250	2 425	1 975	2 125	1 850	1 950	1 800	1 850	1 800
64,0	8	2 300	1 850	2 250	1 800	1 975	1 800	1 950	1 800	1 900	1 800	1 850	1 700
67,1	8	1 800	1 800	1 800	1 800	1 800	1 700	1 700	1 400	1 450	#	#	#
70,1	8	1 625	#	#	#	#	#	#	#	#	#	#	#
73,2	8	#	#	#	#	#	#	#	#	#	#	#	#
76,2	2	#	#	#	#	#	#	#	#	#	#	#	#
79,2	2	#	#	#	#	#	#	#	#	#	#	#	#

Warning: Crane must remain in-line with crawlers when raising over end of blocked crawlers until operating radius is within 360 degree chart. Crane tipping or structural damage can occur.

Explanation of Symbols

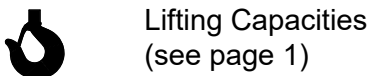
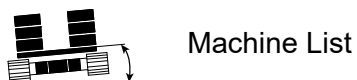
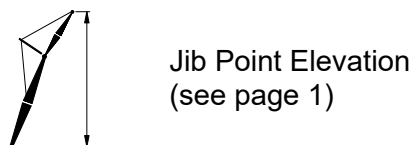
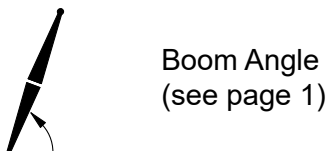
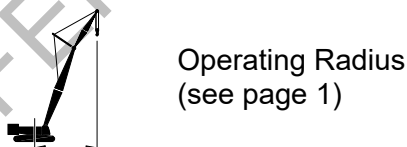
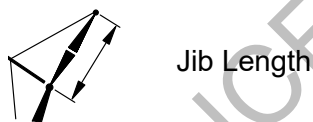
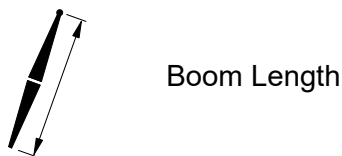
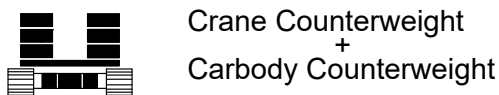
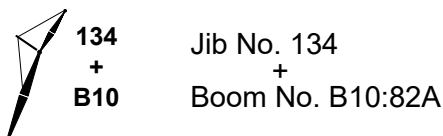

MLC250 S-2

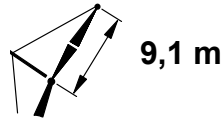
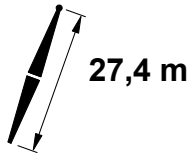
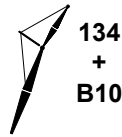

		5°						15°							
	m	°	m	kg	kg	kg	kg	°	m	kg	kg	kg	kg	m	
9,1	79,2	38,3	26 700	26 000										9,1	
10,0	77,8	38,1	26 700	25 700										10,0	
10,7	76,7	37,9	26 700	25 400										10,7	
12,0	74,6	37,5	26 700	24 900	22 400	20 200		79,3	37,7	26 700	24 000			12,0	
12,2	74,2	37,5	26 700	24 800	22 100	19 900		77,1	37,3	26 700	23 600			12,2	
					22 000	19 800		76,7	37,2	26 700	23 600	21 100	19 100		
13,7	71,8	37,0	26 700	24 300	21 600	19 500		74,2	36,7	26 300	23 200	20 800	18 800	13,7	
14,0	71,3	36,9	26 700	24 200	21 500	19 400		73,7	36,6	26 200	23 100	20 700	18 800	14,0	
16,0	67,9	36,1	26 700	23 600	21 100	19 000		70,4	35,8	25 600	22 700	20 400	18 500	16,0	
18,0	64,4	35,2	26 200	23 000	20 600	18 700		66,9	34,9	25 000	22 300	20 100	18 300	18,0	
20,0	60,9	34,1	25 500	22 500	20 200	18 400		63,3	33,8	24 500	21 900	19 800	18 100	20,0	
22,0	57,2	32,8	24 900	22 100	19 900	18 100		59,5	32,5	23 900	21 600	19 600	17 900	22,0	
24,0	53,3	31,4	24 400	21 700	19 600	17 900		55,6	31,1	22 500	21 400	19 400	17 800	24,0	
26,0	49,2	29,7	23 900	21 300	19 300	17 600		51,5	29,4	21 200	21 000	19 300	17 700	26,0	
28,0	44,8	27,7	22 900	21 100	19 100	17 500		47,1	27,4	20 000	19 900	19 200	17 600	28,0	
30,0	40,1	25,5	21 300	20 600	18 900	17 300		42,3	25,1	19 000	19 000	18 800	17 600	30,0	
30,5	38,8	24,8	20 900	20 300	18 900	17 300		41,0	24,4	18 800	18 700	18 600	17 600	30,5	
32,0	34,8	22,7	19 700	19 200	18 700	17 300		36,9	22,3	18 100	18 100	18 100	17 600	32,0	
33,5	29,8	19,9	18 400	18 000	17 500	16 700		32,1	19,7	17 500	17 500	17 500	17 200	33,5	
35,1	24,8	17,1	17 200	16 800	16 400	16 100								35,1	



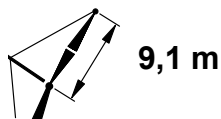
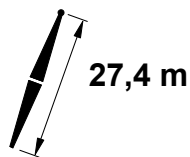





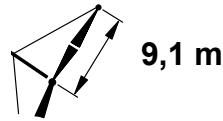
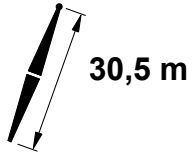
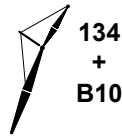

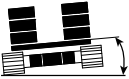
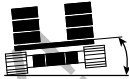
MLC250 S-2



		25°					
		83 730 kg + 19 960 kg					
m	°	m	0° kg	1° kg	2° kg	3° kg	m
9,1							9,1
10,0							10,0
10,7							10,7
12,0							12,0
12,2	79,3	36,7	22 100	21 600			12,2
13,7	76,7	36,2	20 900	20 500	20 000	18 300	13,7
14,0	76,2	36,1	20 700	20 300	19 900	18 200	14,0
16,0	72,8	35,3	19 400	19 000	18 700	18 100	16,0
18,0	69,2	34,3	18 200	17 900	17 600	17 400	18,0
20,0	65,6	33,2	17 200	17 000	16 700	16 500	20,0
22,0	61,8	31,9	16 300	16 100	16 000	15 800	22,0
24,0	57,8	30,4	15 600	15 400	15 300	15 100	24,0
26,0	53,5	28,7	14 900	14 800	14 700	14 600	26,0
28,0	49,0	26,7	14 400	14 300	14 200	14 100	28,0
30,0	44,0	24,3	13 900	13 800	13 800	13 700	30,0
30,5	42,7	23,7	13 800	13 800	13 700	13 600	30,5
32,0							32,0
33,5							33,5
35,1							35,1

MLC250 S-2



		5°						15°							
															
				0°	1°	2°	3°			0°	1°	2°	3°		
															
		m	°	m	kg	kg	kg	kg	°	m	kg	kg	kg	kg	m
9,1	80,0	41,4	26 700												9,1
10,0	78,8	41,2	26 700												10,0
10,7	77,7	41,0	26 700	25 500	22 600	20 200		80,1	40,8	26 700					10,7
12,0	75,8	40,7	26 700	25 100	22 200	19 900		78,1	40,5	26 700					12,0
12,2	75,5	40,6	26 700	25 000	22 100	19 900		77,8	40,4	26 700	23 700	21 100	19 100		12,2
13,7	73,2	40,2	26 700	24 600	21 800	19 600		75,5	40,0	26 400	23 300	20 900	18 900		13,7
14,0	72,8	40,1	26 700	24 500	21 700	19 600		75,1	39,9	26 400	23 300	20 800	18 900		14,0
16,0	69,7	39,4	26 700	23 900	21 200	19 200		72,0	39,1	25 800	22 800	20 500	18 600		16,0
18,0	66,6	38,5	26 500	23 300	20 800	18 800		68,8	38,3	25 300	22 500	20 200	18 400		18,0
20,0	63,3	37,5	25 900	22 800	20 400	18 500		65,6	37,3	24 800	22 100	20 000	18 200		20,0
22,0	60,0	36,4	25 300	22 400	20 100	18 200		62,2	36,2	24 400	21 800	19 700	18 000		22,0
24,0	56,6	35,1	24 700	21 900	19 800	18 000		58,7	34,9	23 600	21 500	19 500	17 900		24,0
26,0	53,0	33,7	24 300	21 600	19 500	17 800		55,1	33,4	22 300	21 300	19 400	17 700		26,0
28,0	49,2	32,0	23 400	21 300	19 300	17 600		51,3	31,7	21 100	20 900	19 300	17 700		28,0
30,0	45,2	30,0	21 300	20 500	19 100	17 400		47,2	29,7	20 100	20 000	19 200	17 600		30,0
32,0	40,8	27,8	19 400	18 800	18 200	17 300		42,8	27,5	19 100	19 000	18 400	17 600		32,0
36,0	30,7	22,0	16 200	15 800	15 400	15 100		32,5	21,6	16 300	15 900	15 500	15 200		36,0
36,6	28,7	20,8	15 800	15 500	15 100	14 700		30,7	20,5	15 900	15 500	15 200	14 800		36,6
38,1	23,7	17,7	14 800	14 500	14 200	13 900									38,1

MLC250 S-2

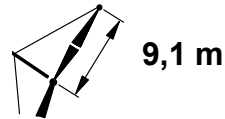
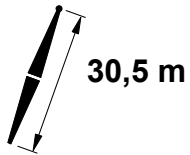

		25°					
		83 730 kg + 19 960 kg					
m	°	m	0° kg	1° kg	2° kg	3° kg	m
9,1							9,1
10,0							10,0
10,7							10,7
12,0							12,0
12,2	80,2	39,9	22 600				12,2
13,7	77,8	39,4	21 400	20 900	20 100	18 300	13,7
14,0	77,4	39,3	21 200	20 800	20 000	18 200	14,0
16,0	74,2	38,6	19 900	19 500	19 200	18 100	16,0
18,0	71,0	37,7	18 800	18 400	18 100	17 800	18,0
20,0	67,7	36,7	17 800	17 500	17 200	17 000	20,0
22,0	64,3	35,6	16 900	16 700	16 500	16 200	22,0
24,0	60,8	34,2	16 100	15 900	15 800	15 600	24,0
26,0	57,1	32,7	15 500	15 300	15 200	15 000	26,0
28,0	53,2	31,0	14 900	14 800	14 600	14 500	28,0
30,0	49,0	29,0	14 400	14 300	14 200	14 100	30,0
32,0	44,5	26,7	14 000	13 900	13 800	13 700	32,0
36,0							36,0
36,6							36,6
38,1							38,1

MLC250 S-2

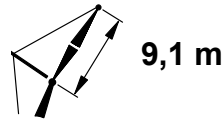
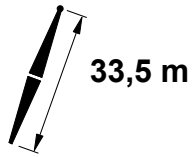

			5°				15°						
			0°	1°	2°	3°			0°	1°	2°	3°	
m	°	m	kg	kg	kg	kg	°	m	kg	kg	kg	kg	m
9,1	80,8	44,5	26 700										9,1
10,0	79,6	44,3	26 700										10,0
10,7	78,6	44,2	26 700	25 700	22 600		80,8	43,9	26 700				10,7
12,0	76,8	43,9	26 700	25 200	22 300		79,0	43,6	26 700				12,0
12,2	76,6	43,8	26 700	25 200	22 200	20 000	78,7	43,6	26 700	23 700	21 200		12,2
13,7	74,5	43,4	26 700	24 700	21 900	19 700	76,6	43,1	26 600	23 400	20 900	18 900	13,7
14,0	74,0	43,3	26 700	24 600	21 800	19 600	76,2	43,1	26 500	23 300	20 900	18 900	14,0
15,2	72,3	42,9	26 700	24 300	21 600	19 400	74,5	42,7	26 200	23 100	20 700	18 700	15,2
16,0	71,2	42,6	26 700	24 000	21 400	19 300	73,3	42,4	26 000	22 900	20 600	18 600	16,0
18,0	68,3	41,9	26 700	23 500	21 000	19 000	70,4	41,6	25 500	22 600	20 300	18 400	18,0
20,0	65,4	41,0	26 200	23 000	20 600	18 600	67,5	40,7	25 000	22 200	20 000	18 200	20,0
22,0	62,4	39,9	25 600	22 600	20 300	18 400	64,4	39,7	24 600	21 900	19 800	18 100	22,0
24,0	59,3	38,8	25 100	22 200	19 900	18 100	61,3	38,5	24 200	21 700	19 600	17 900	24,0
26,0	56,0	37,4	24 600	21 800	19 700	17 900	58,0	37,2	23 500	21 400	19 400	17 800	26,0
28,0	52,7	36,0	23 300	21 500	19 400	17 700	54,7	35,7	22 200	21 300	19 300	17 700	28,0
30,0	49,2	34,3	21 100	20 300	19 200	17 500	51,1	34,0	21 100	20 400	19 200	17 600	30,0
32,0	45,5	32,4	19 100	18 500	17 900	17 300	47,4	32,0	19 300	18 700	18 100	17 400	32,0
35,1	39,1	28,8	16 700	16 200	15 700	15 300	40,9	28,4	16 900	16 400	15 900	15 400	35,1
36,0	37,1	27,6	16 000	15 500	15 100	14 600	38,9	27,2	16 100	15 700	15 200	14 800	36,0
38,1	31,6	24,1	14 700	14 300	13 900	13 500	33,7	24,0	14 700	14 300	13 900	13 600	38,1
40,0	26,7	20,9	13 500	13 200	12 800	12 500							40,0
41,2	22,8	18,3	12 800	12 600	12 300	12 000							41,2

MLC250 S-2

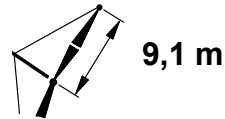
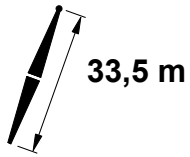
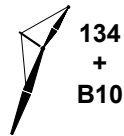

		25°					
		83 730 kg + 19 960 kg					
m	°	m	0° kg	1° kg	2° kg	3° kg	m
9,1							9,1
10,0							10,0
10,7							10,7
12,0							12,0
12,2	80,9	43,0	23 000				12,2
13,7	78,7	42,6	21 900	21 400	20 100		13,7
14,0	78,3	42,5	21 700	21 200	20 000		14,0
15,2	76,6	42,1	20 900	20 500	19 700	18 100	15,2
16,0	75,4	41,8	20 400	20 000	19 600	18 100	16,0
18,0	72,5	41,0	19 300	18 900	18 600	18 000	18,0
20,0	69,5	40,1	18 300	18 000	17 700	17 400	20,0
22,0	66,4	39,1	17 400	17 200	16 900	16 700	22,0
24,0	63,2	37,9	16 700	16 400	16 200	16 000	24,0
26,0	59,9	36,5	16 000	15 800	15 600	15 400	26,0
28,0	56,5	35,0	15 400	15 200	15 100	14 900	28,0
30,0	52,8	33,3	14 900	14 700	14 600	14 500	30,0
32,0	49,0	31,3	14 400	14 300	14 200	14 100	32,0
35,1	42,5	27,7	13 800	13 700	13 700	13 600	35,1
36,0							36,0
38,1							38,1
40,0							40,0
41,2							41,2

MLC250 S-2

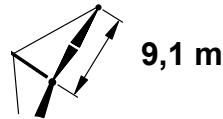
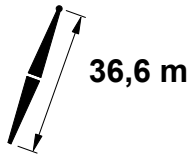

		5°						15°						
 m	 °	 m	0°	1°	2°	3°	 °	 m	0°	1°	2°	3°	 m	
			kg	kg	kg	kg			kg	kg	kg	kg		kg
10,7	79,4	47,3	26 700	25 700										10,7
12,0	77,7	47,0	26 700	25 300										12,0
12,2	77,5	46,9	26 700	25 300	22 300	20 000	79,5	46,7	26 700	23 800				12,2
13,7	75,5	46,5	26 700	24 800	21 900	19 700	77,5	46,3	26 700	23 500	20 900	18 900		13,7
14,0	75,1	46,5	26 700	24 700	21 900	19 700	77,1	46,2	26 600	23 400	20 900	18 900		14,0
15,2	73,6	46,1	26 700	24 400	21 600	19 500	75,5	45,9	26 300	23 200	20 700	18 800		15,2
16,0	72,5	45,9	26 700	24 200	21 500	19 300	74,5	45,6	26 100	23 000	20 600	18 700		16,0
18,0	69,8	45,1	26 700	23 700	21 100	19 000	71,8	44,9	25 600	22 700	20 300	18 500		18,0
20,0	67,1	44,3	26 500	23 200	20 700	18 800	69,1	44,1	25 200	22 400	20 100	18 300		20,0
22,0	64,4	43,4	25 900	22 800	20 400	18 500	66,3	43,1	24 800	22 100	19 900	18 100		22,0
24,0	61,5	42,3	25 400	22 400	20 100	18 200	63,4	42,0	24 400	21 800	19 700	18 000		24,0
26,0	58,6	41,1	24 900	22 000	19 800	18 000	60,5	40,8	24 100	21 600	19 500	17 900		26,0
28,0	55,6	39,8	23 200	21 500	19 600	17 800	57,4	39,5	23 100	21 400	19 400	17 700		28,0
30,0	52,4	38,3	20 900	20 100	19 100	17 600	54,3	38,0	21 200	20 300	19 200	17 600		30,0
32,0	49,2	36,6	19 000	18 300	17 600	17 000	51,0	36,3	19 200	18 500	17 800	17 200		32,0
36,0	42,0	32,5	15 900	15 300	14 800	14 300	43,8	32,2	16 000	15 500	15 000	14 500		36,0
36,6	40,8	31,7	15 500	15 000	14 500	14 000	42,5	31,4	15 700	15 200	14 700	14 200		36,6
40,0	33,7	27,2	13 400	13 000	12 600	12 300	35,3	26,8	13 500	13 100	12 700	12 400		40,0
41,2	30,5	25,0	12 800	12 400	12 100	11 800	32,5	24,8	12 800	12 500	12 200	11 800		41,2
44,0	22,7	19,4	11 300	11 100	10 800	10 600								44,0
44,2	22,0	18,9	11 300	11 000	10 700	10 500								44,2

MLC250 S-2

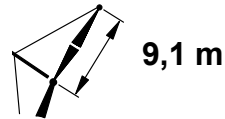
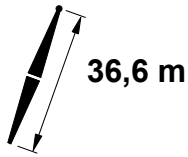
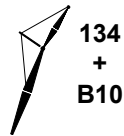

		25°					
		83 730 kg + 19 960 kg					
m	°	m	0° kg	1° kg	2° kg	3° kg	m
10,7							10,7
12,0							12,0
12,2							12,2
13,7	79,5	45,8	22 200	21 700			13,7
14,0	79,1	45,7	22 100	21 600			14,0
15,2	77,5	45,3	21 300	20 900	19 900	18 100	15,2
16,0	76,5	45,1	20 800	20 400	19 700	18 100	16,0
18,0	73,7	44,3	19 700	19 300	19 000	18 000	18,0
20,0	71,0	43,5	18 700	18 400	18 100	17 800	20,0
22,0	68,2	42,5	17 900	17 600	17 400	17 100	22,0
24,0	65,3	41,4	17 100	16 900	16 700	16 400	24,0
26,0	62,3	40,2	16 400	16 200	16 000	15 900	26,0
28,0	59,2	38,8	15 800	15 700	15 500	15 300	28,0
30,0	55,9	37,3	15 300	15 100	15 000	14 900	30,0
32,0	52,6	35,5	14 800	14 700	14 600	14 400	32,0
36,0	45,2	31,3	14 000	13 900	13 900	13 800	36,0
36,6	44,0	30,6	13 900	13 800	13 800	13 700	36,6
40,0							40,0
41,2							41,2
44,0							44,0
44,2							44,2

MLC250 S-2

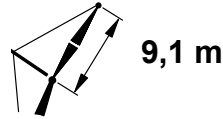
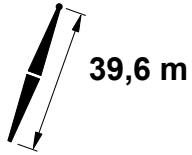
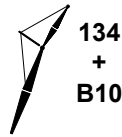

		5°						15°							
		0°				1°		0°				1°			
		2°				3°		2°				3°			
		kg				kg		kg				kg			
		m		°		m		°		m		°		m	
10,7	80,1	50,4	26 700											10,7	
12,0	78,5	50,1	26 700											12,0	
12,2	78,3	50,1	26 700	25 300	22 300			80,2	49,8	26 700				12,2	
13,7	76,4	49,7	26 700	24 900	22 000	19 700		78,3	49,5	26 700	23 500	21 000		13,7	
14,0	76,1	49,6	26 700	24 800	21 900	19 700		78,0	49,4	26 700	23 400	20 900		14,0	
15,2	74,6	49,3	26 700	24 500	21 700	19 500	76,5	49,0	26 400	23 200	20 800	18 800		15,2	
16,0	73,6	49,1	26 700	24 300	21 500	19 400	75,5	48,8	26 300	23 100	20 600	18 700		16,0	
16,8	72,6	48,8	26 700	24 100	21 400	19 300	74,5	48,5	26 100	23 000	20 500	18 600		16,8	
18,0	71,2	48,4	26 700	23 800	21 200	19 100	73,0	48,1	25 800	22 800	20 400	18 500		18,0	
20,0	68,6	47,6	26 700	23 400	20 800	18 800	70,5	47,4	25 300	22 500	20 200	18 300		20,0	
22,0	66,1	46,8	26 200	23 000	20 500	18 600	67,9	46,5	25 000	22 200	20 000	18 200		22,0	
24,0	63,5	45,8	25 600	22 600	20 200	18 300	65,3	45,5	24 600	21 900	19 800	18 000		24,0	
26,0	60,8	44,7	25 100	22 200	19 900	18 100	62,6	44,4	24 200	21 700	19 600	17 900		26,0	
28,0	58,0	43,4	23 000	21 600	19 700	17 900	59,8	43,2	23 300	21 400	19 400	17 800		28,0	
30,0	55,2	42,1	20 700	19 800	18 900	17 700	56,9	41,8	21 000	20 100	19 000	17 700		30,0	
32,0	52,2	40,6	18 800	18 000	17 300	16 600	54,0	40,3	19 100	18 300	17 500	16 800		32,0	
36,0	45,9	37,0	15 700	15 100	14 600	14 000	47,6	36,6	15 900	15 300	14 700	14 200		36,0	
39,6	39,5	32,9	13 400	13 000	12 600	12 100	41,1	32,5	13 600	13 100	12 700	12 300		39,6	
40,0	38,8	32,5	13 200	12 800	12 400	11 900	40,4	32,1	13 300	12 900	12 500	12 100		40,0	
44,0	30,3	26,5	11 200	10 900	10 600	10 300	31,8	26,0	11 300	11 000	10 600	10 300		44,0	
44,2	29,8	26,0	11 100	10 800	10 500	10 200	31,3	25,6	11 200	10 900	10 600	10 300		44,2	
47,2	21,3	19,5	9 800	9 600	9 300	9 100								47,2	

MLC250 S-2

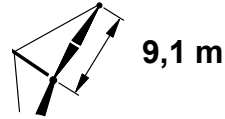
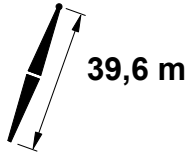
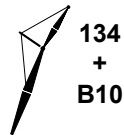

		25°					
		83 730 kg + 19 960 kg					
m	°	m	0° kg	1° kg	2° kg	3° kg	m
10,7							10,7
12,0							12,0
12,2							12,2
13,7	80,2	48,9	22 600				13,7
14,0	79,8	48,8	22 400				14,0
15,2	78,3	48,5	21 700	21 200	19 900		15,2
16,0	77,4	48,3	21 200	20 800	19 800		16,0
16,8	76,3	48,0	20 800	20 400	19 600	18 000	16,8
18,0	74,8	47,6	20 100	19 700	19 300	18 000	18,0
20,0	72,3	46,8	19 200	18 800	18 500	17 900	20,0
22,0	69,7	45,9	18 300	18 000	17 800	17 500	22,0
24,0	67,0	44,9	17 600	17 300	17 100	16 800	24,0
26,0	64,3	43,8	16 900	16 700	16 400	16 200	26,0
28,0	61,4	42,5	16 300	16 100	15 900	15 700	28,0
30,0	58,5	41,1	15 700	15 500	15 400	15 200	30,0
32,0	55,5	39,6	15 200	15 100	14 900	14 800	32,0
36,0	49,0	35,9	14 400	14 300	14 200	14 100	36,0
39,6	42,4	31,7	13 700	13 200	12 800	12 400	39,6
40,0							40,0
44,0							44,0
44,2							44,2
47,2							47,2

MLC250 S-2

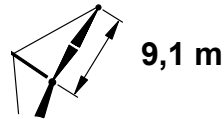
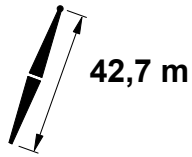

		5°						15°							
				0°	1°	2°	3°			0°	1°	2°	3°		
m	°	m	kg	kg	kg	kg	°	m	kg	kg	kg	kg	m		
10,7	80,7	53,5	26 700											10,7	
12,0	79,2	53,2	26 700											12,0	
12,2	79,0	53,2	26 700	25 300	22 300		80,8	52,9	26 700					12,2	
13,7	77,3	52,8	26 700	24 900	22 000	19 700	79,0	52,6	26 700	23 500				13,7	
14,0	76,9	52,8	26 700	24 900	21 900	19 700	78,7	52,5	26 700	23 500				14,0	
15,2	75,5	52,5	26 700	24 600	21 700	19 500	77,3	52,2	26 500	23 300	20 700	18 700		15,2	
16,0	74,6	52,2	26 700	24 400	21 600	19 400	76,4	52,0	26 300	23 100	20 600	18 700		16,0	
16,8	73,7	52,0	26 700	24 200	21 400	19 300	75,4	51,7	26 100	23 000	20 500	18 600		16,8	
18,0	72,3	51,6	26 700	23 900	21 200	19 100	74,1	51,4	25 900	22 800	20 400	18 500		18,0	
20,0	70,0	50,9	26 700	23 500	20 900	18 800	71,7	50,6	25 500	22 500	20 200	18 300		20,0	
22,0	67,6	50,1	26 400	23 100	20 600	18 600	69,3	49,8	25 100	22 200	20 000	18 200		22,0	
24,0	65,2	49,2	25 900	22 700	20 300	18 400	66,9	48,9	24 700	22 000	19 800	18 000		24,0	
26,0	62,7	48,2	25 300	22 400	20 000	18 200	64,4	47,9	24 400	21 800	19 600	17 900		26,0	
28,0	60,1	47,0	22 800	21 600	19 800	18 000	61,8	46,8	23 200	21 400	19 500	17 800		28,0	
30,0	57,5	45,8	20 600	19 600	18 700	17 600	59,2	45,5	20 900	19 900	18 800	17 700		30,0	
32,0	54,8	44,4	18 700	17 800	17 100	16 300	56,5	44,1	18 900	18 100	17 300	16 600		32,0	
36,0	49,1	41,2	15 500	14 900	14 300	13 700	50,7	40,9	15 700	15 100	14 500	13 900		36,0	
40,0	42,9	37,2	13 100	12 600	12 100	11 700	44,4	36,8	13 200	12 700	12 300	11 800		40,0	
41,2	40,9	35,7	12 500	12 000	11 600	11 200	42,4	35,4	12 600	12 200	11 800	11 300		41,2	
44,0	35,8	32,2	11 000	10 700	10 300	10 000	37,2	31,7	11 200	10 800	10 500	10 100		44,0	
45,7	32,0	29,3	10 300	10 000	9 700	9 400	33,7	29,1	10 400	10 100	9 800	9 500		45,7	
48,0	27,1	25,4	9 400	9 100	8 900	8 600								48,0	
50,3	20,6	20,0	8 500	8 300	8 100	7 900								50,3	

MLC250 S-2

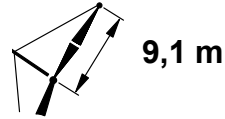
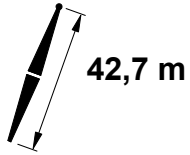
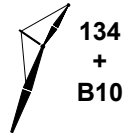

		25°					
		83 730 kg + 19 960 kg					
m	°	m	0° kg	1° kg	2° kg	3° kg	m
10,7							10,7
12,0							12,0
12,2							12,2
13,7	80,8	52,0	22 900				13,7
14,0	80,5	52,0	22 800				14,0
15,2	79,1	51,6	22 000	21 500			15,2
16,0	78,1	51,4	21 600	21 100			16,0
16,8	77,2	51,2	21 200	20 700	19 800	18 000	16,8
18,0	75,8	50,8	20 500	20 100	19 600	17 900	18,0
20,0	73,4	50,1	19 600	19 200	18 900	17 900	20,0
22,0	71,0	49,2	18 700	18 400	18 100	17 700	22,0
24,0	68,5	48,3	18 000	17 700	17 400	17 200	24,0
26,0	66,0	47,3	17 300	17 100	16 800	16 600	26,0
28,0	63,4	46,1	16 700	16 500	16 300	16 100	28,0
30,0	60,7	44,8	16 100	15 900	15 800	15 600	30,0
32,0	58,0	43,4	15 600	15 500	15 300	15 100	32,0
36,0	52,1	40,1	14 800	14 600	14 500	14 100	36,0
40,0	45,7	36,0	13 300	12 900	12 400	12 000	40,0
41,2	43,7	34,7	12 700	12 300	11 800	11 400	41,2
44,0							44,0
45,7							45,7
48,0							48,0
50,3							50,3

MLC250 S-2

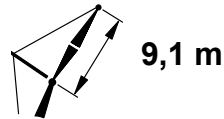
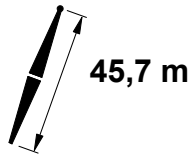

			5°				15°						
m	°	m	kg	kg	kg	kg	°	m	kg	kg	kg	kg	m
12,2	79,6	56,3	26 700	25 300									
13,7	78,0	56,0	26 700	24 900									
14,0	77,7	55,9	26 700	24 900	22 000	19 700	79,6	55,7	26 700	23 500			12,2
15,2	76,4	55,6	26 700	24 600	21 900	19 600	79,3	55,7	26 700	23 400			13,7
16,0	75,5	55,4	26 700	24 400	21 700	19 500	78,0	55,4	26 500	23 200	20 700	18 700	14,0
													15,2
													16,0
16,8	74,6	55,2	26 700	24 200	21 400	19 300	76,3	54,9	26 200	23 000	20 500	18 600	16,8
18,0	73,3	54,8	26 700	24 000	21 200	19 100	75,0	54,6	26 000	22 800	20 400	18 500	18,0
20,0	71,1	54,2	26 700	23 600	20 900	18 900	72,8	53,9	25 500	22 500	20 200	18 300	20,0
22,0	68,9	53,4	26 600	23 200	20 600	18 600	70,5	53,1	25 200	22 300	20 000	18 200	22,0
24,0	66,6	52,5	26 100	22 800	20 400	18 400	68,2	52,3	24 900	22 000	19 800	18 000	24,0
26,0	64,3	51,6	25 200	22 500	20 100	18 200	65,9	51,3	24 500	21 800	19 700	17 900	26,0
28,0	62,0	50,5	22 600	21 400	19 700	18 000	63,5	50,3	22 900	21 300	19 500	17 800	28,0
30,0	59,5	49,4	20 300	19 300	18 300	17 300	61,1	49,1	20 700	19 600	18 600	17 500	30,0
32,0	57,1	48,1	18 400	17 500	16 700	15 900	58,6	47,8	18 700	17 800	17 000	16 200	32,0
36,0	51,9	45,2	15 300	14 600	14 000	13 300	53,4	44,9	15 500	14 800	14 200	13 600	36,0
40,0	46,3	41,6	12 800	12 300	11 800	11 300	47,8	41,3	13 000	12 500	12 000	11 500	40,0
44,0	40,1	37,2	10 800	10 400	10 000	9 600	41,5	36,8	10 900	10 500	10 100	9 800	44,0
44,2	39,7	36,9	10 700	10 300	9 900	9 600	41,1	36,5	10 800	10 400	10 100	9 700	44,2
48,0	32,9	31,6	9 100	8 800	8 500	8 200	34,2	31,2	9 200	8 900	8 600	8 300	48,0
48,8	31,2	30,2	8 900	8 600	8 300	8 000	32,7	29,9	8 900	8 600	8 300	8 100	48,8
52,0	23,9	24,0	7 700	7 500	7 300	7 100							52,0
53,3	20,0	20,5	7 300	7 100	6 900	6 700							53,3

MLC250 S-2

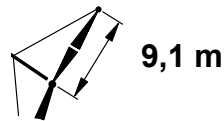
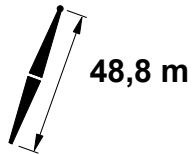

			5°				15°							
			0°	1°	2°	3°			0°	1°	2°	3°		
m	°	m	kg	kg	kg	kg	°	m	kg	kg	kg	kg	m	
12,2	80,2	59,4	26 700										12,2	
13,7	78,6	59,1	26 700	24 900	21 900			80,2	58,9	26 700			13,7	
14,0	78,3	59,0	26 700	24 900	21 900			79,9	58,8	26 700			14,0	
15,2	77,1	58,8	26 700	24 600	21 700	19 400		78,7	58,5	26 500	23 200	20 600	15,2	
16,0	76,3	58,6	26 700	24 400	21 500	19 300		77,9	58,3	26 400	23 100	20 600	16,0	
16,8	75,5	58,3	26 700	24 300	21 400	19 200		77,0	58,1	26 200	23 000	20 500	18 500	16,8
18,0	74,2	58,0	26 700	24 000	21 200	19 100		75,8	57,8	26 000	22 800	20 400	18 400	18,0
18,3	73,9	57,9	26 700	24 000	21 200	19 000		75,5	57,7	25 900	22 800	20 300	18 400	18,3
20,0	72,2	57,4	26 700	23 600	20 900	18 900		73,7	57,1	25 600	22 500	20 200	18 300	20,0
22,0	70,1	56,7	26 600	23 300	20 700	18 600		71,6	56,4	25 300	22 300	20 000	18 100	22,0
24,0	67,9	55,9	26 300	22 900	20 400	18 400		69,5	55,6	24 900	22 100	19 800	18 000	24,0
26,0	65,8	55,0	25 000	22 600	20 100	18 200		67,3	54,7	24 500	21 800	19 700	17 900	26,0
28,0	63,6	54,0	22 400	21 100	19 600	18 000		65,1	53,7	22 800	21 200	19 500	17 800	28,0
30,0	61,3	52,9	20 200	19 100	18 100	17 100		62,8	52,6	20 500	19 400	18 400	17 200	30,0
32,0	59,0	51,7	18 200	17 300	16 400	15 600		60,5	51,4	18 500	17 600	16 700	15 900	32,0
36,0	54,2	49,0	15 100	14 400	13 700	13 100		55,7	48,7	15 300	14 600	13 900	13 300	36,0
40,0	49,1	45,8	12 600	12 100	11 500	11 000		50,5	45,4	12 800	12 300	11 700	11 200	40,0
44,0	43,6	41,9	10 600	10 200	9 800	9 400		45,0	41,5	10 800	10 300	9 900	9 500	44,0
45,7	40,9	39,8	9 900	9 500	9 100	8 800		42,3	39,4	10 100	9 700	9 300	8 900	45,7
48,0	37,4	37,0	9 000	8 600	8 300	8 000		38,7	36,6	9 100	8 700	8 400	8 100	48,0
51,8	30,4	31,2	7 600	7 400	7 100	6 900		31,7	30,7	7 700	7 400	7 200	6 900	51,8
52,0	30,1	30,9	7 600	7 300	7 100	6 800								52,0
54,9	23,7	25,0	6 700	6 500	6 300	6 100								54,9

MLC250 S-2

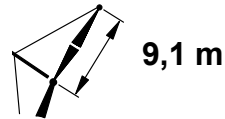
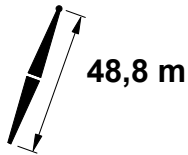
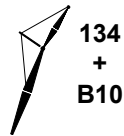

		25°					
		83 730 kg + 19 960 kg					
m	°	m	0° kg	1° kg	2° kg	3° kg	m
12,2							12,2
13,7							13,7
14,0							14,0
15,2	80,2	57,9	22 600				15,2
16,0	79,4	57,7	22 200				16,0
16,8	78,6	57,5	21 800	21 300	19 600		16,8
18,0	77,4	57,2	21 200	20 800	19 600		18,0
18,3	77,0	57,1	21 100	20 600	19 600	17 800	18,3
20,0	75,3	56,5	20 300	19 900	19 500	17 800	20,0
22,0	73,1	55,8	19 500	19 100	18 800	17 700	22,0
24,0	71,0	55,0	18 700	18 400	18 100	17 700	24,0
26,0	68,8	54,1	18 100	17 800	17 500	17 200	26,0
28,0	66,5	53,1	17 400	17 200	16 900	16 700	28,0
30,0	64,2	52,0	16 900	16 700	16 400	16 200	30,0
32,0	61,9	50,8	16 400	16 200	16 000	15 800	32,0
36,0	57,0	48,0	15 300	14 800	14 200	13 500	36,0
40,0	51,8	44,7	13 000	12 400	11 900	11 400	40,0
44,0	46,1	40,7	10 900	10 500	10 000	9 600	44,0
45,7	43,4	38,7	10 100	9 700	9 300	9 000	45,7
48,0							48,0
51,8							51,8
52,0							52,0
54,9							54,9

MLC250 S-2

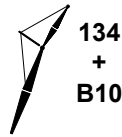



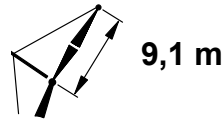
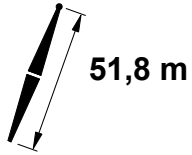





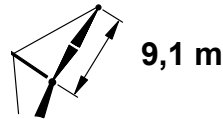
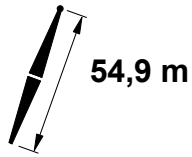

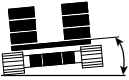
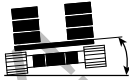

83 730 kg
+
19 960 kg



		5°						15°						
			0°	1°	2°	3°			0°	1°	2°	3°		
m	°	m	kg	kg	kg	kg	°	m	kg	kg	kg	kg	m	
12,2	80,7	62,5	26 700	24 900			80,7	62,0	26 700				12,2	
13,7	79,2	62,2	26 700	24 800			80,4	61,9	26 700				13,7	
14,0	78,9	62,2	26 700	24 800			79,3	61,6	26 500	23 100			14,0	
15,2	77,8	61,9	26 700	24 600	21 600	19 300	78,5	61,5	26 400	23 100			15,2	
16,0	77,0	61,7	26 700	24 400	21 500	19 300	77,7	61,2	26 300	23 000	20 400	18 400	16,0	
16,8	76,2	61,5	26 700	24 200	21 400	19 200	76,5	60,9	26 000	22 800	20 300	18 400	16,8	
18,0	75,0	61,2	26 700	24 000	21 200	19 000	76,2	60,8	26 000	22 800	20 300	18 300	18,0	
18,3	74,7	61,1	26 700	23 900	21 100	19 000	74,6	60,3	25 700	22 500	20 100	18 200	18,3	
20,0	73,1	60,6	26 700	23 600	20 900	18 800	72,6	59,6	25 300	22 300	20 000	18 100	20,0	
22,0	71,1	59,9	26 700	23 300	20 700	18 600	70,6	58,9	25 000	22 100	19 800	18 000	22,0	
24,0	69,1	59,2	26 300	22 900	20 400	18 400	68,5	58,1	24 600	21 900	19 700	17 800	24,0	
26,0	67,1	58,3	24 800	22 600	20 200	18 200	66,4	57,1	22 600	21 100	19 300	17 800	26,0	
28,0	65,0	57,4	22 200	20 900	19 500	17 900	64,3	56,1	20 300	19 200	18 100	17 000	28,0	
30,0	62,9	56,4	20 000	18 800	17 700	16 700	62,2	55,0	18 300	17 300	16 400	15 500	30,0	
32,0	60,7	55,3	18 000	17 000	16 100	15 200	57,7	52,5	15 200	14 400	13 700	13 000	32,0	
36,0	56,3	52,8	14 900	14 100	13 400	12 700	53,0	49,5	12 600	12 000	11 500	10 900	36,0	
40,0	51,6	49,8	12 400	11 800	11 300	10 700	47,9	45,9	10 600	10 100	9 700	9 200	40,0	
44,0	46,6	46,2	10 400	9 900	9 500	9 100	42,3	41,6	8 900	8 500	8 200	7 800	44,0	
48,0	41,1	41,9	8 800	8 400	8 000	7 700	41,1	40,5	8 600	8 300	7 900	7 600	48,0	
48,8	39,9	40,9	8 500	8 100	7 800	7 500	36,0	36,2	7 500	7 200	6 900	6 600	48,8	
52,0	34,8	36,7	7 400	7 100	6 800	6 500	30,8	31,5	6 600	6 300	6 100	5 800	52,0	
54,9	29,5	31,8	6 500	6 300	6 000	5 800							54,9	
56,0	27,4	29,8	6 200	6 000	5 700	5 500							56,0	
57,9	23,1	25,7	5 700	5 500	5 300	5 100							57,9	

MLC250 S-2

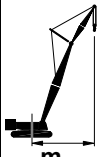

		5°						15°						
														
														
	m	°	m	kg	kg	kg	kg	°	m	kg	kg	kg	kg	m
13,7	79,7	65,3	26 700	24 800										13,7
14,0	79,5	65,3	26 700	24 700										14,0
15,2	78,4	65,0	26 700	24 500	21 500		79,8	64,8	26 500	23 100				15,2
16,0	77,6	64,8	26 700	24 300	21 400		79,1	64,6	26 400	23 000				16,0
16,8	76,9	64,6	26 700	24 200	21 300	19 100	78,3	64,4	26 200	22 900	20 400			16,8
18,0	75,8	64,3	26 700	24 000	21 100	19 000	77,2	64,1	26 000	22 700	20 200			18,0
18,3	75,5	64,3	26 700	23 900	21 100	18 900	76,9	64,0	26 000	22 700	20 200	18 300		18,3
19,8	74,1	63,8	26 700	23 600	20 900	18 800	75,5	63,6	25 700	22 500	20 100	18 100		19,8
20,0	73,9	63,8	26 700	23 600	20 900	18 700	75,3	63,5	25 700	22 500	20 100	18 100		20,0
22,0	72,0	63,1	26 700	23 300	20 600	18 600	73,4	62,9	25 300	22 300	19 900	18 000		22,0
24,0	70,1	62,4	26 400	23 000	20 400	18 400	71,5	62,2	25 000	22 000	19 800	17 900		24,0
26,0	68,2	61,6	24 600	22 600	20 100	18 200	69,6	61,4	24 700	21 800	19 600	17 800		26,0
28,0	66,3	60,8	22 000	20 600	19 300	17 800	67,6	60,5	22 400	21 000	19 200	17 700		28,0
30,0	64,3	59,8	19 800	18 600	17 500	16 400	65,6	59,5	20 200	18 900	17 800	16 800		30,0
32,0	62,3	58,8	17 800	16 800	15 800	14 900	63,6	58,5	18 200	17 100	16 100	15 200		32,0
36,0	58,1	56,4	14 700	13 900	13 200	12 400	59,4	56,1	15 000	14 200	13 400	12 700		36,0
40,0	53,7	53,6	12 200	11 600	11 000	10 400	55,1	53,3	12 500	11 800	11 200	10 700		40,0
44,0	49,1	50,4	10 200	9 700	9 300	8 800	50,4	50,0	10 400	9 900	9 400	9 000		44,0
48,0	44,1	46,5	8 600	8 200	7 800	7 400	45,4	46,1	8 700	8 300	7 900	7 600		48,0
50,3	41,0	43,8	7 800	7 400	7 100	6 800	42,2	43,4	7 900	7 600	7 200	6 900		50,3
52,0	38,6	41,9	7 200	6 900	6 600	6 300	39,8	41,4	7 300	7 000	6 700	6 400		52,0
56,0	32,4	36,1	6 000	5 800	5 500	5 300	33,5	35,6	6 100	5 800	5 600	5 300		56,0
56,4	31,6	35,4	5 900	5 700	5 400	5 200	32,8	35,0	6 000	5 700	5 500	5 300		56,4
60,0	24,7	28,5	5 000	4 800	4 600	4 400								60,0
61,0	22,5	26,2	4 800	4 600	4 400	4 200								61,0

MLC250 S-2

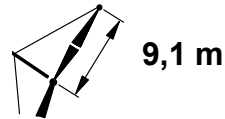
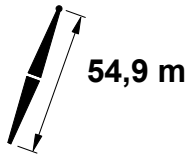

		25°					
		83 730 kg + 19 960 kg					
m	°	m	0° kg	1° kg	2° kg	3° kg	m
13,7							13,7
14,0							14,0
15,2							15,2
16,0							16,0
16,8	79,8	63,8	22 400	21 700			16,8
18,0	78,6	63,5	21 800	21 300			18,0
18,3	78,3	63,4	21 700	21 200	19 400		18,3
19,8	76,9	63,0	21 000	20 600	19 400	17 600	19,8
20,0	76,7	62,9	20 900	20 500	19 400	17 600	20,0
22,0	74,8	62,3	20 100	19 700	19 200	17 600	22,0
24,0	72,9	61,6	19 400	19 000	18 700	17 500	24,0
26,0	70,9	60,8	18 700	18 400	18 100	17 500	26,0
28,0	69,0	59,9	18 100	17 800	17 600	17 300	28,0
30,0	66,9	58,9	17 600	17 300	17 000	16 800	30,0
32,0	64,9	57,9	17 000	16 800	16 500	15 500	32,0
36,0	60,7	55,5	15 200	14 400	13 700	12 900	36,0
40,0	56,2	52,6	12 700	12 000	11 400	10 800	40,0
44,0	51,5	49,3	10 600	10 100	9 600	9 100	44,0
48,0	46,4	45,3	8 900	8 500	8 100	7 700	48,0
50,3	43,2	42,7	8 000	7 600	7 300	7 000	50,3
52,0							52,0
56,0							56,0
56,4							56,4
60,0							60,0
61,0							61,0

MLC250 S-2

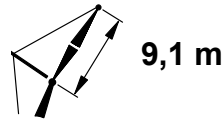
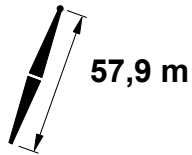

		5°						15°							
		0°				1°		0°				1°			
		2°				3°		2°				3°			
		kg				kg		kg				kg			
		m				°		m				°			
13,7	80,2	68,4	26 700											13,7	
14,0	79,9	68,4	26 700											14,0	
15,2	78,9	68,1	26 700	24 400	21 400			80,2	67,9	26 500				15,2	
16,0	78,2	68,0	26 700	24 200	21 300			79,6	67,7	26 300				16,0	
16,8	77,5	67,8	26 700	24 100	21 200	19 000		78,8	67,5	26 200	22 800	20 300		16,8	
18,0	76,4	67,5	26 700	23 900	21 000	18 900	77,8	67,2	26 000	22 600	20 100			18,0	
18,3	76,2	67,4	26 700	23 800	21 000	18 800	77,5	67,1	25 900	22 600	20 100	18 200		18,3	
19,8	74,8	67,0	26 700	23 600	20 800	18 700	76,2	66,7	25 700	22 500	20 000	18 100		19,8	
20,0	74,7	67,0	26 700	23 600	20 800	18 700	76,0	66,7	25 700	22 400	20 000	18 100		20,0	
22,0	72,9	66,3	26 700	23 200	20 600	18 500	74,2	66,1	25 300	22 200	19 800	17 900		22,0	
24,0	71,1	65,7	26 500	22 900	20 300	18 300	72,4	65,4	25 000	22 000	19 700	17 800		24,0	
26,0	69,3	64,9	24 400	22 600	20 100	18 100	70,6	64,6	24 700	21 800	19 500	17 700		26,0	
28,0	67,4	64,1	21 800	20 300	19 000	17 600	68,7	63,8	22 200	20 700	19 100	17 500		28,0	
30,0	65,5	63,2	19 500	18 300	17 100	16 000	66,8	62,9	19 900	18 700	17 500	16 400		30,0	
32,0	63,6	62,2	17 600	16 500	15 500	14 500	64,9	61,9	18 000	16 800	15 800	14 900		32,0	
36,0	59,7	60,0	14 500	13 600	12 800	12 100	61,0	59,7	14 700	13 900	13 100	12 300		36,0	
40,0	55,6	57,4	12 000	11 300	10 700	10 100	56,9	57,1	12 200	11 500	10 900	10 300		40,0	
44,0	51,4	54,4	10 000	9 400	8 900	8 500	52,6	54,1	10 200	9 600	9 100	8 600		44,0	
48,0	46,8	50,8	8 300	7 900	7 500	7 100	48,0	50,5	8 500	8 100	7 600	7 200		48,0	
52,0	41,8	46,6	6 900	6 600	6 300	5 900	43,0	46,2	7 100	6 700	6 400	6 100		52,0	
53,3	40,0	44,9	6 500	6 200	5 900	5 600	41,1	44,5	6 700	6 300	6 000	5 700		53,3	
56,0	36,3	41,6	5 800	5 500	5 200	4 900	37,4	41,2	5 900	5 600	5 300	5 000		56,0	
59,4	30,9	36,2	4 900	4 600	4 400	4 200	32,0	35,8	4 900	4 700	4 500	4 300		59,4	
60,0	30,0	35,3	4 700	4 500	4 300	4 100								60,0	
64,0	22,0	26,8	3 800	3 700	3 500	3 300								64,0	

MLC250 S-2

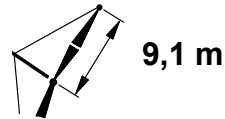
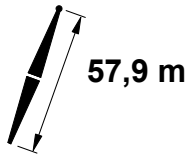
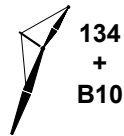

		25°					
		83 730 kg + 19 960 kg					
m	°	m	0° kg	1° kg	2° kg	3° kg	m
13,7							13,7
14,0							14,0
15,2							15,2
16,0							16,0
16,8	80,3	66,9	22 600				16,8
18,0	79,2	66,6	22 100				18,0
18,3	78,9	66,6	21 900	21 500	19 300		18,3
19,8	77,5	66,1	21 300	20 800	19 300	17 500	19,8
20,0	77,4	66,1	21 200	20 800	19 300	17 500	20,0
22,0	75,6	65,5	20 400	20 000	19 200	17 500	22,0
24,0	73,7	64,8	19 700	19 300	18 900	17 500	24,0
26,0	71,9	64,0	19 000	18 700	18 400	17 400	26,0
28,0	70,0	63,2	18 400	18 100	17 800	17 400	28,0
30,0	68,1	62,3	17 900	17 600	17 300	16 600	30,0
32,0	66,2	61,3	17 300	17 100	16 100	15 200	32,0
36,0	62,2	59,0	15 000	14 200	13 400	12 600	36,0
40,0	58,0	56,4	12 400	11 800	11 100	10 500	40,0
44,0	53,7	53,3	10 400	9 800	9 300	8 800	44,0
48,0	49,0	49,7	8 600	8 200	7 800	7 400	48,0
52,0	43,9	45,4	7 200	6 800	6 500	6 200	52,0
53,3	42,1	43,7	6 700	6 400	6 100	5 800	53,3
56,0							56,0
59,4							59,4
60,0							60,0
64,0							64,0



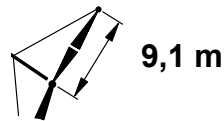
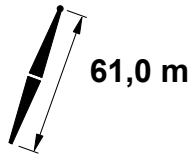





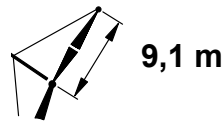
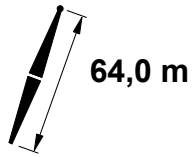

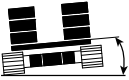
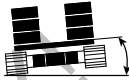



MLC250 S-2



		5°						15°						
			0°	1°	2°	3°			0°	1°	2°	3°		
m	°	m	kg	kg	kg	kg	°	m	kg	kg	kg	kg	m	
13,7	80,6	71,5	26 700										13,7	
14,0	80,4	71,5	26 700										14,0	
15,2	79,4	71,2	26 700	24 300			80,7	71,0	26 400				15,2	
16,0	78,7	71,1	26 700	24 100			80,0	70,8	26 300				16,0	
16,8	78,0	70,9	26 700	24 000	21 100		79,3	70,6	26 100	22 700			16,8	
18,0	77,0	70,6	26 700	23 800	20 900		78,3	70,4	25 900	22 600			18,0	
18,3	76,8	70,6	26 700	23 800	20 900	18 700	78,1	70,3	25 900	22 500	20 000		18,3	
19,8	75,5	70,2	26 700	23 500	20 700	18 600	76,8	69,9	25 700	22 400	19 900	18 000	19,8	
20,0	75,4	70,1	26 700	23 500	20 700	18 500	76,6	69,9	25 600	22 300	19 900	17 900	20,0	
21,3	74,2	69,7	26 700	23 300	20 500	18 400	75,5	69,5	25 400	22 200	19 800	17 900	21,3	
22,0	73,7	69,5	26 700	23 200	20 500	18 400	74,9	69,3	25 300	22 100	19 700	17 800	22,0	
24,0	71,9	68,9	26 500	22 900	20 300	18 200	73,2	68,6	25 000	22 000	19 600	17 700	24,0	
26,0	70,2	68,2	24 200	22 400	20 000	18 100	71,5	67,9	24 700	21 700	19 500	17 700	26,0	
28,0	68,4	67,4	21 600	20 100	18 600	17 400	69,7	67,1	22 000	20 500	18 900	17 300	28,0	
30,0	66,7	66,6	19 300	18 000	16 800	15 700	67,9	66,3	19 800	18 400	17 200	16 100	30,0	
32,0	64,9	65,6	17 400	16 300	15 200	14 200	66,1	65,3	17 800	16 600	15 500	14 500	32,0	
36,0	61,2	63,5	14 300	13 400	12 600	11 800	62,4	63,2	14 600	13 700	12 800	12 100	36,0	
40,0	57,3	61,1	11 800	11 100	10 400	9 800	58,6	60,8	12 000	11 300	10 700	10 000	40,0	
44,0	53,3	58,3	9 800	9 200	8 700	8 200	54,5	57,9	10 000	9 400	8 900	8 400	44,0	
48,0	49,1	55,0	8 100	7 700	7 200	6 800	50,3	54,6	8 300	7 900	7 400	7 000	48,0	
52,0	44,6	51,1	6 800	6 400	6 000	5 700	45,7	50,8	6 900	6 500	6 200	5 800	52,0	
54,9	41,0	47,9	5 900	5 600	5 300	5 000	42,1	47,5	6 000	5 700	5 400	5 100	54,9	
56,0	39,6	46,6	5 600	5 300	5 000	4 700	40,7	46,2	5 700	5 400	5 100	4 800	56,0	
60,0	34,1	41,2	4 600	4 300	4 100	3 800	35,1	40,7	4 600	4 400	4 100	3 900	60,0	
62,5	30,1	36,9	4 000	3 800	3 600	3 400	31,2	36,6	4 100	3 800	3 600	3 400	62,5	
64,0	27,6	34,3	3 700	3 500	3 300	3 100							64,0	
67,1	21,4	27,4	3 000	2 900	2 700	2 600							67,1	

MLC250 S-2



		5°						15°						
														
														
m	°	m	kg	kg	kg	kg	°	m	kg	kg	kg	kg	m	
13,7	81,0	74,6	26 700										13,7	
14,0	80,8	74,6	26 700										14,0	
15,2	79,8	74,3	26 700	24 100									15,2	
16,0	79,2	74,2	26 700	24 000									16,0	
16,8	78,6	74,0	26 700	23 900	20 900		79,8	73,8	26 000	22 600			16,8	
18,0	77,6	73,8	26 700	23 700	20 800		78,8	73,5	25 800	22 400			18,0	
18,3	77,3	73,7	26 700	23 600	20 800	18 600	78,6	73,4	25 800	22 400	19 900		18,3	
19,8	76,1	73,3	26 700	23 400	20 600	18 500	77,4	73,1	25 600	22 300	19 800	17 800	19,8	
20,0	76,0	73,3	26 700	23 400	20 600	18 400	77,2	73,0	25 500	22 200	19 800	17 800	20,0	
21,3	74,9	72,9	26 700	23 200	20 400	18 300	76,2	72,6	25 400	22 100	19 700	17 800	21,3	
22,0	74,4	72,7	26 700	23 100	20 300	18 300	75,6	72,5	25 300	22 100	19 600	17 700	22,0	
24,0	72,7	72,1	26 500	22 800	20 100	18 100	73,9	71,8	25 000	21 900	19 500	17 600	24,0	
26,0	71,1	71,4	24 000	22 100	19 900	17 900	72,3	71,2	24 500	21 700	19 400	17 500	26,0	
28,0	69,4	70,7	21 400	19 800	18 300	17 000	70,6	70,4	21 900	20 200	18 800	17 100	28,0	
30,0	67,7	69,9	19 100	17 800	16 500	15 300	68,9	69,6	19 600	18 200	16 900	15 700	30,0	
32,0	66,0	69,0	17 200	16 000	14 900	13 900	67,2	68,7	17 600	16 400	15 300	14 200	32,0	
36,0	62,5	67,0	14 000	13 100	12 300	11 500	63,7	66,7	14 400	13 400	12 600	11 700	36,0	
40,0	58,9	64,7	11 600	10 800	10 100	9 500	60,0	64,4	11 800	11 100	10 400	9 700	40,0	
44,0	55,1	62,0	9 600	9 000	8 400	7 900	56,3	61,7	9 800	9 200	8 600	8 100	44,0	
48,0	51,2	59,0	7 900	7 400	7 000	6 500	52,3	58,6	8 100	7 600	7 200	6 700	48,0	
52,0	47,0	55,4	6 500	6 100	5 800	5 400	48,1	55,1	6 700	6 300	5 900	5 500	52,0	
56,0	42,5	51,3	5 400	5 000	4 700	4 400	43,5	50,9	5 500	5 200	4 800	4 500	56,0	
57,9	40,1	49,0	4 900	4 600	4 300	4 000	41,2	48,6	5 000	4 700	4 400	4 100	57,9	
60,0	37,5	46,4	4 300	4 100	3 800	3 500	38,6	46,0	4 400	4 200	3 900	3 600	60,0	
64,0	31,9	40,5	3 400	3 200	3 000	2 800	32,9	40,0	3 500	3 300	3 100	2 900	64,0	
65,5	29,4	37,7	3 100	2 900	2 700	2 500	30,5	37,4	3 200	3 000	2 800	2 600	65,5	
68,0	25,3	33,0	2 700	2 500	2 300	2 100							68,0	
70,1	21,0	27,9	2 300	2 100	2 000	1 800							70,1	

MLC250 S-2

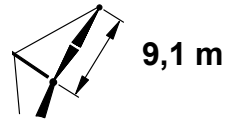
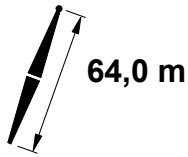
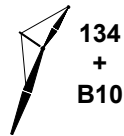

		25°					
		83 730 kg + 19 960 kg					
m	°	m	0° kg	1° kg	2° kg	3° kg	m
13,7							13,7
14,0							14,0
15,2							15,2
16,0							16,0
16,8							16,8
18,0							18,0
18,3	79,9	72,8	22 400	21 300			18,3
19,8	78,6	72,5	21 800	21 200	19 000		19,8
20,0	78,5	72,4	21 700	21 200	19 000		20,0
21,3	77,4	72,0	21 200	20 700	19 000	17 300	21,3
22,0	76,8	71,9	21 000	20 500	19 000	17 300	22,0
24,0	75,2	71,2	20 300	19 900	18 900	17 200	24,0
26,0	73,5	70,5	19 600	19 200	18 900	17 200	26,0
28,0	71,8	69,8	19 000	18 700	18 400	17 100	28,0
30,0	70,1	69,0	18 500	18 100	17 200	16 100	30,0
32,0	68,3	68,1	17 900	16 700	15 600	14 600	32,0
36,0	64,8	66,1	14 700	13 700	12 900	12 000	36,0
40,0	61,1	63,7	12 100	11 300	10 600	10 000	40,0
44,0	57,3	61,0	10 000	9 400	8 800	8 300	44,0
48,0	53,3	57,9	8 300	7 800	7 300	6 900	48,0
52,0	49,0	54,3	6 800	6 400	6 000	5 700	52,0
56,0	44,4	50,1	5 600	5 300	4 900	4 600	56,0
57,9	42,0	47,8	5 100	4 800	4 500	4 200	57,9
60,0							60,0
64,0							64,0
65,5							65,5
68,0							68,0
70,1							70,1

MLC250 S-2

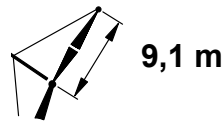
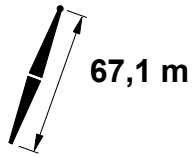

		5°						15°						
		0°	1°	2°	3°			0°	1°	2°	3°			
		kg	kg	kg	kg			kg	kg	kg	kg			
m	°	m				°	m					m		
15,2	80,2	77,4	26 700										15,2	
16,0	79,6	77,3	26 700										16,0	
16,8	79,0	77,1	26 700	23 700			80,3	76,9	25 900				16,8	
18,0	78,1	76,9	26 700	23 500			79,3	76,6	25 700				18,0	
18,3	77,9	76,8	26 700	23 500	20 600	18 200	79,1	76,5	25 700	22 300			18,3	
19,8	76,7	76,5	26 700	23 200	20 400	18 100	77,9	76,2	25 500	22 100	19 600	17 700	19,8	
20,0	76,6	76,4	26 700	23 200	20 400	18 100	77,7	76,2	25 400	22 100	19 600	17 700	20,0	
21,3	75,5	76,1	26 700	23 000	20 300	18 100	76,7	75,8	25 300	22 000	19 500	17 600	21,3	
22,0	75,0	75,9	26 700	22 900	20 200	18 100	76,2	75,6	25 200	21 900	19 500	17 600	22,0	
24,0	73,4	75,3	26 400	22 700	20 000	18 000	74,6	75,0	24 900	21 700	19 400	17 500	24,0	
26,0	71,8	74,7	23 800	21 800	19 800	17 800	73,0	74,4	24 300	21 500	19 300	17 400	26,0	
28,0	70,3	73,9	21 200	19 500	18 000	16 600	71,4	73,7	21 700	20 000	18 500	16 900	28,0	
30,0	68,6	73,2	18 900	17 500	16 200	15 000	69,8	72,9	19 400	17 900	16 600	15 400	30,0	
32,0	67,0	72,3	17 000	15 800	14 600	13 600	68,2	72,0	17 400	16 100	15 000	13 900	32,0	
36,0	63,7	70,4	13 800	12 900	12 000	11 200	64,8	70,2	14 200	13 200	12 300	11 500	36,0	
40,0	60,3	68,3	11 400	10 600	9 900	9 200	61,4	68,0	11 700	10 900	10 200	9 500	40,0	
44,0	56,7	65,8	9 400	8 700	8 200	7 600	57,8	65,4	9 600	9 000	8 400	7 800	44,0	
48,0	53,0	62,9	7 700	7 200	6 700	6 300	54,1	62,6	7 900	7 400	6 900	6 500	48,0	
52,0	49,1	59,6	6 300	5 900	5 500	5 100	50,2	59,2	6 500	6 100	5 700	5 300	52,0	
56,0	44,9	55,8	5 200	4 800	4 500	4 200	46,0	55,4	5 300	5 000	4 600	4 300	56,0	
59,4	41,1	52,0	4 300	4 000	3 700	3 400	42,1	51,6	4 400	4 100	3 800	3 500	59,4	
60,0	40,5	51,3	4 100	3 900	3 600	3 300	41,5	50,9	4 300	4 000	3 700	3 400	60,0	
64,0	35,5	46,1	3 300	3 000	2 800	2 600	36,5	45,7	3 400	3 100	2 900	2 600	64,0	
67,1	31,2	41,2	2 700	2 400	2 200	2 000	32,2	40,9	2 700	2 500	2 300	2 100	67,1	
68,0	29,8	39,7	2 500	2 300	2 100	1 900							68,0	
68,6	28,9	38,6	2 400	2 200	2 000	1 800							68,6	
70,1	26,3	35,5	2 100	1 900									70,1	
71,6	23,7	32,4	1 800										71,6	

MLC250 S-2

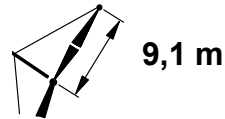
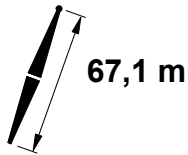









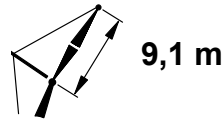
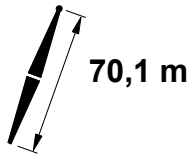

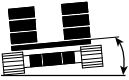
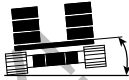



		25°					
		83 730 kg + 19 960 kg					
m	°	m	0° kg	1° kg	2° kg	3° kg	m
15,2							15,2
16,0							16,0
16,8							16,8
18,0							18,0
18,3	80,3	76,0	22 600				18,3
19,8	79,1	75,6	22 000	21 100			19,8
20,0	78,9	75,6	22 000	21 100			20,0
21,3	77,9	75,2	21 500	20 900	18 900	16 600	21,3
22,0	77,4	75,0	21 200	20 800	18 800	16 600	22,0
24,0	75,8	74,4	20 500	20 100	18 800	16 500	24,0
26,0	74,2	73,8	19 900	19 500	18 700	16 500	26,0
28,0	72,6	73,1	19 300	18 900	18 400	16 500	28,0
30,0	70,9	72,3	18 700	18 100	17 000	15 700	30,0
32,0	69,3	71,4	17 800	16 500	15 300	14 300	32,0
36,0	65,9	69,5	14 500	13 500	12 600	11 800	36,0
40,0	62,4	67,3	11 900	11 100	10 400	9 700	40,0
44,0	58,8	64,7	9 800	9 200	8 600	8 000	44,0
48,0	55,1	61,8	8 100	7 600	7 100	6 600	48,0
52,0	51,1	58,5	6 700	6 200	5 800	5 400	52,0
56,0	46,8	54,6	5 400	5 100	4 700	4 400	56,0
59,4	42,9	50,7	4 500	4 200	3 900	3 600	59,4
60,0							60,0
64,0							64,0
67,1							67,1
68,0							68,0
68,6							68,6
70,1							70,1
71,6							71,6

MLC250 S-2



83 730 kg
+
19 960 kg

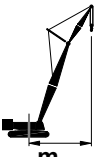

		5°						15°						
														
														
m	°	m	kg	kg	kg	kg	°	m	kg	kg	kg	kg	m	
15,2	80,6	80,5	26 700										15,2	
16,0	80,0	80,4	26 700										16,0	
16,8	79,4	80,2	26 700	23 500			80,6	80,0	25 800				16,8	
18,0	78,6	80,0	26 700	23 300			79,7	79,7	25 600				18,0	
18,3	78,3	79,9	26 700	23 300	20 400		79,5	79,7	25 500	22 100			18,3	
19,8	77,2	79,6	26 700	23 100	20 300	16 200	78,4	79,3	25 300	22 000	19 500		19,8	
20,0	77,1	79,6	26 700	23 100	20 200	16 200	78,2	79,3	25 300	21 900	19 500		20,0	
21,3	76,1	79,2	26 600	22 900	20 100	16 200	77,3	78,9	25 100	21 800	19 400	15 800	21,3	
22,0	75,6	79,0	26 600	22 800	20 000	16 200	76,7	78,8	25 100	21 800	19 300	15 800	22,0	
22,9	74,9	78,8	26 400	22 700	20 000	16 100	76,1	78,5	25 000	21 700	19 300	15 800	22,9	
24,0	74,1	78,5	26 100	22 500	19 900	16 100	75,2	78,2	24 800	21 600	19 200	15 700	24,0	
26,0	72,6	77,9	23 600	21 500	19 600	16 100	73,7	77,6	24 100	21 400	19 100	15 700	26,0	
28,0	71,0	77,2	20 900	19 200	17 700	15 800	72,2	76,9	21 500	19 700	18 100	15 700	28,0	
30,0	69,5	76,4	18 700	17 200	15 900	14 600	70,6	76,2	19 200	17 600	16 300	15 000	30,0	
32,0	67,9	75,6	16 700	15 400	14 300	13 200	69,1	75,4	17 200	15 900	14 700	13 500	32,0	
36,0	64,8	73,8	13 600	12 600	11 700	10 800	65,9	73,6	13 900	12 900	12 000	11 100	36,0	
40,0	61,5	71,8	11 100	10 300	9 600	8 900	62,6	71,5	11 400	10 600	9 800	9 100	40,0	
44,0	58,1	69,4	9 100	8 500	7 800	7 300	59,2	69,1	9 400	8 700	8 100	7 500	44,0	
48,0	54,7	66,7	7 400	6 900	6 400	5 900	55,7	66,4	7 700	7 100	6 600	6 100	48,0	
52,0	51,0	63,6	6 100	5 600	5 200	4 800	52,0	63,2	6 300	5 800	5 400	5 000	52,0	
56,0	47,1	60,0	4 900	4 500	4 200	3 800	48,1	59,7	5 000	4 700	4 300	4 000	56,0	
60,0	43,0	56,0	3 900	3 600	3 300	3 000	44,0	55,6	4 000	3 700	3 400	3 100	60,0	
62,5	40,2	53,0	3 300	3 000	2 800	2 500	41,2	52,6	3 400	3 200	2 900	2 600	62,5	
64,0	38,5	51,2	3 000	2 700	2 500	2 200	39,5	50,8	3 100	2 800	2 600	2 300	64,0	
65,5	36,6	49,1	2 700	2 400	2 200	2 000	37,5	48,7	2 800	2 500	2 300	2 100	65,5	
67,1	34,7	46,9	2 400	2 200	1 900		35,6	46,5	2 500	2 200	2 000	1 800	67,1	
68,0	33,5	45,6	2 200	2 000			34,4	45,2	2 300	2 100			68,0	
68,6	32,7	44,7	2 100	1 900			33,6	44,2	2 200	2 000			68,6	
70,1	30,6	42,2	1 800				31,5	41,7	1 900				70,1	

MLC250 S-2

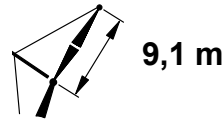
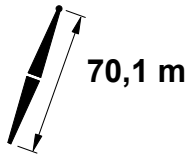
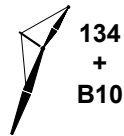

		25°					
		83 730 kg + 19 960 kg					
m	°	m	0° kg	1° kg	2° kg	3° kg	m
15,2							15,2
16,0							16,0
16,8							16,8
18,0							18,0
18,3	80,7	79,1	22 900				18,3
19,8	79,5	78,7	22 300	20 900			19,8
20,0	79,4	78,7	22 200	20 900			20,0
21,3	78,4	78,4	21 700	20 800	18 700		21,3
22,0	77,9	78,2	21 400	20 800	18 700		22,0
22,9	77,2	77,9	21 100	20 600	18 700	14 900	22,9
24,0	76,3	77,6	20 800	20 300	18 600	14 900	24,0
26,0	74,8	77,0	20 100	19 700	18 600	14 900	26,0
28,0	73,3	76,3	19 500	19 200	18 200	14 800	28,0
30,0	71,7	75,5	19 000	18 000	16 700	14 800	30,0
32,0	70,1	74,7	17 600	16 200	15 000	13 900	32,0
36,0	66,9	72,9	14 300	13 300	12 300	11 400	36,0
40,0	63,6	70,8	11 700	10 900	10 100	9 400	40,0
44,0	60,2	68,4	9 600	8 900	8 300	7 700	44,0
48,0	56,7	65,6	7 900	7 300	6 800	6 300	48,0
52,0	52,9	62,5	6 400	6 000	5 500	5 100	52,0
56,0	49,0	58,9	5 200	4 800	4 400	4 100	56,0
60,0	44,8	54,7	4 100	3 800	3 500	3 200	60,0
62,5	42,0	51,8	3 500	3 200	3 000	2 700	62,5
64,0							64,0
65,5							65,5
67,1							67,1
68,0							68,0
68,6							68,6
70,1							70,1

MLC250 S-2



83 730 kg
+
19 960 kg

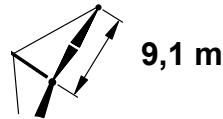
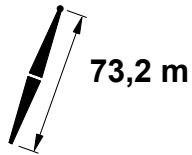

		5°						15°						
			0°	1°	2°	3°			0°	1°	2°	3°		
m	°	m	kg	kg	kg	kg	°	m	kg	kg	kg	kg	m	
15,2	80,9	83,6	26 700										15,2	
16,0	80,4	83,5	26 700										16,0	
16,8	79,8	83,3	26 700	23 300			81,0	83,1	25 600				16,8	
18,0	79,0	83,1	26 700	23 100			80,1	82,9	25 400				18,0	
18,3	78,8	83,1	26 700	23 000	19 100		79,9	82,8	25 400	21 900			18,3	
19,8	77,7	82,7	26 700	22 800	19 000	14 500	78,8	82,5	25 200	21 800	18 600		19,8	
20,0	77,6	82,7	26 700	22 800	18 900	14 500	78,7	82,4	25 200	21 800	18 600		20,0	
21,3	76,6	82,4	26 500	22 700	18 900	14 500	77,7	82,1	25 000	21 600	18 500	14 200	21,3	
22,0	76,1	82,2	26 400	22 600	18 800	14 400	77,2	81,9	24 900	21 600	18 500	14 100	22,0	
22,9	75,5	81,9	26 200	22 500	18 800	14 400	76,6	81,7	24 800	21 500	18 500	14 100	22,9	
24,0	74,7	81,7	26 000	22 300	18 700	14 400	75,8	81,4	24 700	21 400	18 400	14 000	24,0	
26,0	73,2	81,1	23 400	21 300	18 600	14 300	74,3	80,8	23 900	21 200	18 300	14 000	26,0	
28,0	71,8	80,4	20 700	19 000	17 300	14 300	72,9	80,1	21 300	19 400	17 800	14 000	28,0	
30,0	70,3	79,7	18 500	17 000	15 600	14 000	71,4	79,4	19 000	17 400	16 000	13 900	30,0	
32,0	68,8	78,9	16 500	15 200	14 000	12 900	69,9	78,7	17 000	15 600	14 400	13 200	32,0	
36,0	65,8	77,2	13 400	12 300	11 400	10 500	66,8	76,9	13 800	12 700	11 700	10 800	36,0	
40,0	62,7	75,2	10 900	10 100	9 300	8 600	63,7	74,9	11 200	10 400	9 600	8 900	40,0	
44,0	59,5	73,0	8 900	8 200	7 600	7 000	60,5	72,7	9 200	8 500	7 800	7 200	44,0	
48,0	56,2	70,4	7 200	6 700	6 200	5 700	57,2	70,1	7 500	6 900	6 400	5 900	48,0	
52,0	52,7	67,5	5 900	5 400	5 000	4 500	53,7	67,2	6 100	5 600	5 200	4 700	52,0	
56,0	49,1	64,2	4 700	4 300	3 900	3 600	50,1	63,8	4 900	4 500	4 100	3 700	56,0	
60,0	45,3	60,4	3 700	3 300	3 000	2 700	46,2	60,0	3 800	3 500	3 200	2 900	60,0	
64,0	41,1	56,1	2 800	2 500	2 200	2 000	42,1	55,7	2 900	2 600	2 400	2 100	64,0	
65,5	39,4	54,1	2 500	2 200	2 000		40,3	53,7	2 600	2 300	2 100	1 800	65,5	
67,1	37,7	52,2	2 200	1 900			38,6	51,7	2 300	2 000	1 800		67,1	
68,0	36,7	51,0	2 000				37,6	50,6	2 100				68,0	
68,6	36,0	50,2	1 900				36,9	49,7	2 000				68,6	

MLC250 S-2

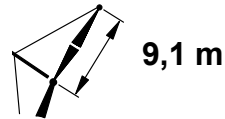
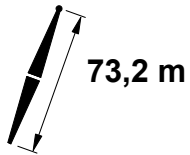
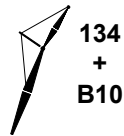

		25°					
		83 730 kg + 19 960 kg					
m	°	m	0° kg	1° kg	2° kg	3° kg	m
15,2							15,2
16,0							16,0
16,8							16,8
18,0							18,0
18,3	81,0	82,2	23 100				18,3
19,8	79,9	81,9	22 500	20 800			19,8
20,0	79,8	81,8	22 400	20 800			20,0
21,3	78,8	81,5	21 900	20 700	17 700		21,3
22,0	78,3	81,3	21 700	20 700	17 600		22,0
22,9	77,7	81,1	21 400	20 600	17 600	13 400	22,9
24,0	76,9	80,8	21 000	20 500	17 600	13 400	24,0
26,0	75,4	80,2	20 400	20 000	17 500	13 300	26,0
28,0	73,9	79,5	19 800	19 300	17 500	13 300	28,0
30,0	72,4	78,8	19 100	17 900	16 400	13 300	30,0
32,0	70,9	78,0	17 400	16 000	14 800	13 200	32,0
36,0	67,9	76,3	14 100	13 000	12 100	11 100	36,0
40,0	64,7	74,3	11 500	10 700	9 900	9 100	40,0
44,0	61,5	72,0	9 400	8 700	8 100	7 500	44,0
48,0	58,1	69,4	7 700	7 100	6 600	6 100	48,0
52,0	54,6	66,4	6 200	5 800	5 300	4 900	52,0
56,0	50,9	63,0	5 000	4 600	4 200	3 900	56,0
60,0	47,0	59,2	3 900	3 600	3 300	3 000	60,0
64,0	42,8	54,8	3 000	2 700	2 400	2 200	64,0
65,5							65,5
67,1							67,1
68,0							68,0
68,6							68,6

MLC250 S-2

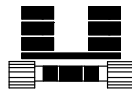

83 730 kg
+
19 960 kg

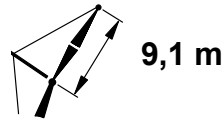
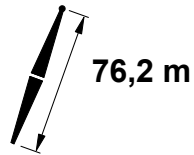

		5°						15°						
			0°	1°	2°	3°			0°	1°	2°	3°		
m	°	m	kg	kg	kg	kg	°	m	kg	kg	kg	kg	m	
16,8	80,2	86,5	26 700										16,8	
18,0	79,4	86,2	26 700										18,0	
18,3	79,2	86,2	26 700	22 800			80,3	85,9	25 200				18,3	
19,8	78,1	85,9	26 600	22 600	17 100		79,2	85,6	25 000	21 500			19,8	
20,0	78,0	85,8	26 600	22 600	17 100		79,1	85,5	25 000	21 500			20,0	
21,3	77,1	85,5	26 300	22 400	17 000	12 900	78,2	85,2	24 800	21 400	16 700		21,3	
22,0	76,6	85,3	26 200	22 300	17 000	12 800	77,7	85,1	24 700	21 400	16 700		22,0	
22,9	76,0	85,1	26 100	22 200	16 900	12 800	77,1	84,8	24 600	21 300	16 600	12 600	22,9	
24,0	75,3	84,8	25 900	22 100	16 900	12 800	76,3	84,6	24 500	21 200	16 600	12 500	24,0	
24,4	75,0	84,7	25 400	21 900	16 900	12 700	76,0	84,4	24 400	21 200	16 600	12 500	24,4	
26,0	73,9	84,3	23 400	21 300	16 800	12 700	74,9	84,0	24 000	21 000	16 500	12 400	26,0	
28,0	72,4	83,6	20 800	19 000	16 600	12 600	73,5	83,3	21 400	19 500	16 400	12 400	28,0	
30,0	71,0	82,9	18 600	17 000	15 500	12 600	72,1	82,7	19 100	17 400	15 800	12 300	30,0	
32,0	69,6	82,2	16 600	15 200	14 000	12 500	70,6	81,9	17 100	15 700	14 400	12 300	32,0	
36,0	66,7	80,6	13 500	12 400	11 400	10 500	67,7	80,3	13 800	12 700	11 700	10 800	36,0	
40,0	63,7	78,7	11 000	10 100	9 300	8 600	64,7	78,4	11 300	10 400	9 600	8 900	40,0	
44,0	60,7	76,5	9 000	8 300	7 600	7 000	61,7	76,2	9 200	8 500	7 900	7 200	44,0	
48,0	57,5	74,1	7 300	6 700	6 200	5 700	58,5	73,8	7 600	7 000	6 400	5 900	48,0	
52,0	54,3	71,3	5 900	5 500	5 000	4 600	55,2	71,0	6 100	5 700	5 200	4 700	52,0	
56,0	50,9	68,2	4 800	4 400	4 000	3 600	51,8	67,8	4 900	4 500	4 100	3 800	56,0	
60,0	47,3	64,7	3 700	3 400	3 100	2 800	48,2	64,3	3 900	3 600	3 200	2 900	60,0	
64,0	43,5	60,6	2 900	2 600	2 300	2 000	44,4	60,2	3 000	2 700	2 400	2 100	64,0	
65,5	41,9	58,9	2 600	2 300	2 000		42,8	58,5	2 700	2 400	2 100	1 900	65,5	
67,1	40,3	57,1	2 300	2 000			41,2	56,7	2 400	2 100	1 900		67,1	
68,0	39,4	56,0	2 100				40,2	55,6	2 200	1 900			68,0	
68,6	38,7	55,3	2 000				39,6	54,8	2 100	1 800			68,6	
70,1							37,9	52,8	1 800				70,1	

MLC250 S-2

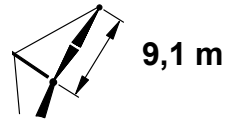
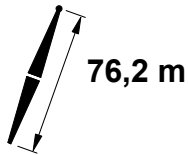
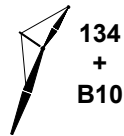

				25°					
				83 730 kg + 19 960 kg					
				0°	1°	2°	3°		
				kg	kg	kg	kg		
				ONLY!					
m	°	m	kg	kg	kg	kg	m		
16,8								16,8	
18,0								18,0	
18,3								18,3	
19,8	80,3	85,0	22 700					19,8	
20,0	80,2	84,9	22 600					20,0	
21,3	79,2	84,6	22 100	20 500				21,3	
22,0	78,8	84,5	21 900	20 500				22,0	
22,9	78,1	84,2	21 600	20 500	16 000			22,9	
24,0	77,4	83,9	21 200	20 400	15 900			24,0	
24,4	77,1	83,8	21 100	20 400	15 900	11 900		24,4	
26,0	76,0	83,4	20 600	20 200	15 800	11 900		26,0	
28,0	74,5	82,7	20 000	19 500	15 800	11 800		28,0	
30,0	73,1	82,0	19 200	17 900	15 700	11 800		30,0	
32,0	71,6	81,3	17 500	16 100	14 800	11 800		32,0	
36,0	68,7	79,6	14 200	13 100	12 100	11 100		36,0	
40,0	65,7	77,7	11 600	10 700	9 900	9 100		40,0	
44,0	62,6	75,5	9 500	8 800	8 100	7 500		44,0	
48,0	59,4	73,1	7 800	7 200	6 600	6 100		48,0	
52,0	56,1	70,3	6 300	5 800	5 400	4 900		52,0	
56,0	52,6	67,1	5 100	4 700	4 300	3 900		56,0	
60,0	49,0	63,5	4 000	3 700	3 300	3 000		60,0	
64,0	45,1	59,4	3 100	2 800	2 500	2 200		64,0	
65,5	43,5	57,6	2 800	2 500	2 200	1 900		65,5	
67,1	41,9	55,8	2 400	2 200	1 900			67,1	
68,0								68,0	
68,6								68,6	
70,1								70,1	

MLC250 S-2

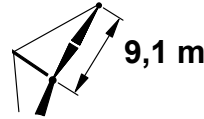
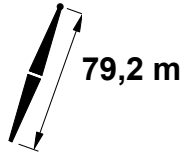
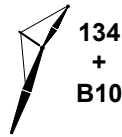

	5°			15°			
	m	°	m	kg	°	m	
16,8	80,6	89,6	26 700				16,8
18,0	79,8	89,3	26 600				18,0
18,3	79,6	89,3	26 500	80,6	89,0	24 900	18,3
19,8	78,6	89,0	26 300	79,6	88,7	24 700	19,8
20,0	78,4	88,9	26 200	79,5	88,7	24 700	20,0
22,0	77,1	88,5	25 900	78,1	88,2	24 500	22,0
24,0	75,8	88,0	25 600	76,8	87,7	24 300	24,0
26,0	74,4	87,4	23 300	75,4	87,2	23 800	26,0
28,0	73,1	86,8	20 600	74,1	86,5	21 200	28,0
30,0	71,7	86,2	18 400	72,7	85,9	18 900	30,0
32,0	70,3	85,5	16 400	71,3	85,2	16 900	32,0
36,0	67,5	83,9	13 300	68,5	83,6	13 600	36,0
40,0	64,7	82,1	10 800	65,7	81,8	11 100	40,0
44,0	61,8	80,0	8 800	62,8	79,7	9 000	44,0
48,0	58,8	77,7	7 100	59,7	77,4	7 400	48,0
52,0	55,7	75,1	5 700	56,6	74,7	5 900	52,0
56,0	52,5	72,1	4 600	53,4	71,8	4 700	56,0
60,0	49,1	68,8	3 500	50,0	68,4	3 700	60,0
64,0	45,5	65,0	2 700	46,4	64,6	2 800	64,0
68,0	41,7	60,7	1 900	42,6	60,3	2 000	68,0
68,6	41,2	60,1	1 800	42,0	59,7	1 900	68,6

MLC250 S-2

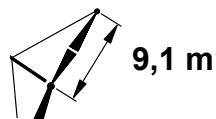
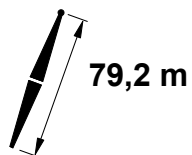

25°				
0°				
m	°	m	kg	m
16,8				16,8
18,0				18,0
18,3				18,3
19,8	80,6	88,1	22 800	19,8
20,0	80,5	88,1	22 800	20,0
22,0	79,2	87,6	22 100	22,0
24,0	77,8	87,1	21 400	24,0
26,0	76,5	86,5	20 800	26,0
28,0	75,1	85,9	20 200	28,0
30,0	73,7	85,3	19 200	30,0
32,0	72,3	84,6	17 300	32,0
36,0	69,5	83,0	14 000	36,0
40,0	66,6	81,1	11 400	40,0
44,0	63,7	79,0	9 300	44,0
48,0	60,6	76,7	7 600	48,0
52,0	57,5	74,0	6 100	52,0
56,0	54,2	71,0	4 900	56,0
60,0	50,8	67,6	3 800	60,0
64,0	47,2	63,8	2 900	64,0
68,0	43,3	59,4	2 100	68,0
68,6	42,7	58,8	2 000	68,6

MLC250 S-2

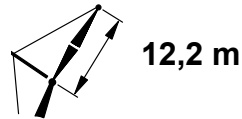
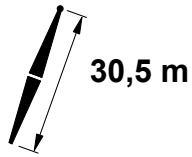

		5°						15°						
			0°	1°	2°	3°			0°	1°	2°	3°		
	m	°	kg	kg	kg	kg	°	m	kg	kg	kg	kg	m	
10,7	79,3	44,2	24 500	20 600									10,7	
12,0	77,5	43,8	23 900	20 300									12,0	
12,2	77,2	43,8	23 900	20 200	17 600	15 600	80,1	43,5	22 000				12,2	
13,7	75,1	43,4	23 300	19 800	17 300	15 300	77,9	43,0	21 500	18 600	16 300	14 600	13,7	
14,0	74,7	43,3	23 200	19 700	17 200	15 300	77,5	43,0	21 500	18 500	16 300	14 500	14,0	
15,2	73,0	42,9	22 700	19 400	17 000	15 100	75,8	42,5	21 200	18 300	16 100	14 400	15,2	
16,0	71,8	42,6	22 500	19 200	16 800	15 000	74,7	42,3	21 000	18 100	16 000	14 300	16,0	
16,8	70,7	42,3	22 200	19 000	16 700	14 900	73,5	42,0	20 800	18 000	15 900	14 300	16,8	
18,0	69,0	41,8	21 800	18 700	16 400	14 700	71,8	41,5	20 600	17 800	15 800	14 200	18,0	
20,0	66,0	40,9	21 200	18 300	16 100	14 400	68,8	40,6	20 100	17 500	15 500	14 000	20,0	
22,0	63,0	39,9	20 600	17 800	15 800	14 100	65,7	39,6	19 400	17 300	15 300	13 800	22,0	
24,0	59,9	38,7	20 100	17 500	15 500	13 900	62,6	38,4	18 100	17 000	15 100	13 700	24,0	
26,0	56,7	37,4	19 700	17 100	15 200	13 700	59,3	37,0	17 100	16 800	15 000	13 500	26,0	
28,0	53,3	35,9	19 200	16 800	15 000	13 500	56,0	35,5	16 100	16 100	14 800	13 400	28,0	
30,0	49,8	34,2	18 200	16 500	14 700	13 300	52,4	33,8	15 300	15 300	14 700	13 300	30,0	
32,0	46,1	32,3	17 100	16 300	14 600	13 200	48,6	31,9	14 600	14 500	14 400	13 300	32,0	
35,1	39,7	28,7	15 700	15 400	14 400	13 000	42,2	28,2	13 600	13 600	13 500	13 200	35,1	
36,0	37,8	27,6	15 300	15 100	14 300	12 900	40,1	27,1	13 300	13 300	13 300	13 100	36,0	
38,1	32,2	24,1	14 500	14 400	13 900	12 900	34,9	23,8	12 800	12 800	12 800	12 700	38,1	
40,0	27,3	20,9	13 800	13 700	13 400	12 800							40,0	
41,2	23,4	18,3	13 500	13 200	12 900	12 600							41,2	

MLC250 S-2

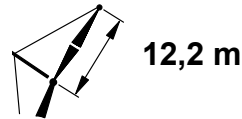
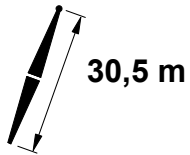

		25°					
		83 730 kg + 19 960 kg					
m	°	m	0° kg	1° kg	2° kg	3° kg	m
10,7							10,7
12,0							12,0
12,2							12,2
13,7	80,8	42,4	18 200				13,7
14,0	80,4	42,3	18 000				14,0
15,2	78,7	41,9	17 300	16 900	15 300		15,2
16,0	77,5	41,6	16 900	16 500	15 300		16,0
16,8	76,3	41,3	16 500	16 200	15 200	13 700	16,8
18,0	74,5	40,8	15 900	15 600	15 200	13 700	18,0
20,0	71,5	39,9	15 100	14 800	14 600	13 600	20,0
22,0	68,4	38,8	14 300	14 100	13 900	13 500	22,0
24,0	65,2	37,6	13 600	13 500	13 300	13 100	24,0
26,0	61,9	36,2	13 100	12 900	12 800	12 600	26,0
28,0	58,4	34,7	12 500	12 400	12 300	12 200	28,0
30,0	54,7	32,9	12 100	12 000	11 900	11 800	30,0
32,0	50,8	30,9	11 700	11 600	11 500	11 400	32,0
35,1	44,3	27,3	11 200	11 100	11 100	11 000	35,1
36,0							36,0
38,1							38,1
40,0							40,0
41,2							41,2

MLC250 S-2

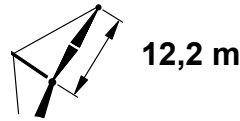
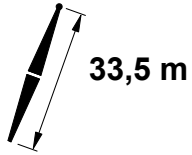
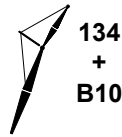

		5°						15°							
				0°	1°	2°	3°			0°	1°	2°	3°		
m	°	m	kg	kg	kg	kg	°	m	kg	kg	kg	kg	m		
10,7	80,0	47,3	24 700											10,7	
12,0	78,3	47,0	24 100											12,0	
12,2	78,1	46,9	24 000	20 300	17 600		80,8	46,6	22 000					12,2	
13,7	76,1	46,5	23 500	19 900	17 400	15 400	78,8	46,2	21 700	18 600	16 300			13,7	
14,0	75,7	46,5	23 400	19 800	17 300	15 300	78,4	46,1	21 600	18 500	16 300			14,0	
15,2	74,2	46,1	23 000	19 500	17 100	15 200	76,8	45,7	21 300	18 400	16 200	14 500		15,2	
16,0	73,1	45,8	22 700	19 300	16 900	15 000	75,7	45,5	21 100	18 200	16 100	14 400		16,0	
16,8	72,0	45,5	22 400	19 100	16 800	14 900	74,7	45,2	21 000	18 100	16 000	14 300		16,8	
18,0	70,4	45,1	22 100	18 900	16 500	14 800	73,1	44,8	20 700	17 900	15 800	14 200		18,0	
20,0	67,7	44,3	21 500	18 400	16 200	14 500	70,3	43,9	20 300	17 600	15 600	14 000		20,0	
22,0	65,0	43,3	21 000	18 100	15 900	14 300	67,5	43,0	19 900	17 400	15 400	13 900		22,0	
24,0	62,1	42,3	20 500	17 700	15 700	14 000	64,7	41,9	18 900	17 200	15 200	13 700		24,0	
26,0	59,2	41,1	20 000	17 400	15 400	13 800	61,7	40,7	17 800	16 900	15 100	13 600		26,0	
28,0	56,2	39,7	19 600	17 000	15 100	13 600	58,7	39,4	16 900	16 700	14 900	13 500		28,0	
30,0	53,0	38,2	19 200	16 800	14 900	13 500	55,5	37,8	16 000	16 000	14 800	13 400		30,0	
32,0	49,7	36,5	18 200	16 500	14 700	13 300	52,2	36,1	15 200	15 200	14 700	13 300		32,0	
36,0	42,6	32,5	16 200	15 700	14 400	13 000	44,9	32,0	14 000	13 900	13 900	13 300		36,0	
36,6	41,4	31,7	15 900	15 400	14 200	13 000	43,7	31,2	13 800	13 800	13 700	13 200		36,6	
40,0	34,2	27,2	13 800	13 500	13 100	12 700	36,4	26,6	13 000	12 900	12 900	12 800		40,0	
41,2	31,1	24,9	13 300	12 900	12 600	12 200	33,5	24,6	12 700	12 700	12 700	12 300		41,2	
44,0	23,2	19,3	11 800	11 500	11 300	11 000								44,0	
44,2	22,5	18,8	11 700	11 400	11 200	10 900								44,2	

MLC250 S-2

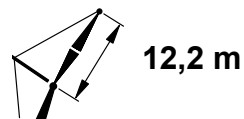

		25°					
		83 730 kg + 19 960 kg					
m	°	m	0° kg	1° kg	2° kg	3° kg	m
10,7							10,7
12,0							12,0
12,2							12,2
13,7							13,7
14,0							14,0
15,2	79,4	45,0	17 600	17 200			15,2
16,0	78,4	44,8	17 200	16 900			16,0
16,8	77,3	44,5	16 800	16 500	15 300	13 700	16,8
18,0	75,7	44,1	16 300	16 000	15 200	13 700	18,0
20,0	72,9	43,2	15 400	15 200	14 900	13 600	20,0
22,0	70,0	42,2	14 700	14 500	14 200	13 500	22,0
24,0	67,1	41,1	14 000	13 800	13 600	13 400	24,0
26,0	64,1	39,9	13 400	13 300	13 100	12 900	26,0
28,0	61,0	38,5	12 900	12 800	12 600	12 500	28,0
30,0	57,7	37,0	12 500	12 300	12 200	12 100	30,0
32,0	54,3	35,2	12 000	11 900	11 800	11 700	32,0
36,0	46,8	31,0	11 400	11 300	11 200	11 200	36,0
36,6	45,7	30,2	11 300	11 200	11 100	11 100	36,6
40,0							40,0
41,2							41,2
44,0							44,0
44,2							44,2

MLC250 S-2

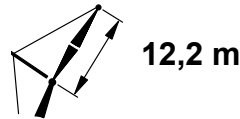
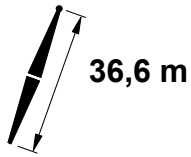

			5°				15°						
			0°	1°	2°	3°			0°	1°	2°	3°	
m	°	m	kg	kg	kg	kg	°	m	kg	kg	kg	kg	m
10,7	80,7	50,4	24 700										10,7
12,0	79,1	50,1	24 200										12,0
12,2	78,8	50,1	24 200	20 400	17 700								12,2
13,7	77,0	49,7	23 700	20 000	17 400	15 400	79,5	49,4	21 700	18 600			13,7
14,0	76,7	49,6	23 600	19 900	17 300	15 400	79,1	49,3	21 700	18 600			14,0
15,2	75,2	49,3	23 100	19 600	17 100	15 200	77,7	48,9	21 400	18 400	16 200	14 500	15,2
16,0	74,2	49,0	22 900	19 500	17 000	15 100	76,7	48,7	21 200	18 300	16 100	14 400	16,0
16,8	73,2	48,8	22 600	19 300	16 900	15 000	75,7	48,4	21 100	18 200	16 000	14 300	16,8
18,0	71,7	48,4	22 300	19 000	16 700	14 800	74,2	48,0	20 800	18 000	15 900	14 200	18,0
18,3	71,3	48,3	22 200	18 900	16 600	14 800	73,8	47,9	20 800	17 900	15 900	14 200	18,3
20,0	69,2	47,6	21 700	18 600	16 300	14 600	71,6	47,3	20 500	17 700	15 700	14 100	20,0
22,0	66,6	46,7	21 200	18 200	16 100	14 400	69,1	46,4	20 100	17 500	15 500	13 900	22,0
24,0	64,0	45,7	20 700	17 900	15 800	14 100	66,4	45,4	19 600	17 300	15 300	13 800	24,0
26,0	61,3	44,6	20 300	17 600	15 500	13 900	63,7	44,3	18 500	17 000	15 200	13 700	26,0
28,0	58,6	43,4	19 900	17 300	15 300	13 700	60,9	43,0	17 600	16 900	15 000	13 600	28,0
30,0	55,7	42,1	19 500	17 000	15 100	13 600	58,1	41,7	16 700	16 500	14 900	13 500	30,0
32,0	52,8	40,5	19 200	16 700	14 900	13 400	55,1	40,1	15 900	15 900	14 800	13 400	32,0
36,0	46,5	37,0	16 200	15 600	14 500	13 100	48,7	36,5	14 600	14 500	14 400	13 300	36,0
39,6	40,0	32,9	13 900	13 500	13 000	12 500	42,1	32,3	13 600	13 500	13 200	12 700	39,6
40,0	39,4	32,4	13 700	13 300	12 900	12 500	41,5	31,9	13 500	13 400	13 000	12 600	40,0
44,0	30,9	26,4	11 700	11 400	11 100	10 800	32,8	25,7	11 800	11 500	11 200	10 900	44,0
44,2	30,3	26,0	11 600	11 300	11 000	10 700	32,3	25,4	11 700	11 400	11 100	10 800	44,2
47,2	21,8	19,4	10 300	10 100	9 800	9 600							47,2

MLC250 S-2

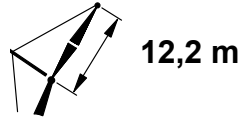
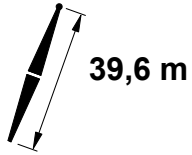
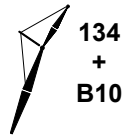

		5°						15°							
				0°	1°	2°	3°			0°	1°	2°	3°		
		m	°	m	kg	kg	kg	kg	°	m	kg	kg	kg	kg	m
12,2	79,5	53,2	24 300	20 400	17 400	15 500	80,1	52,5	21 800					12,2	
13,7	77,8	52,8	23 800	20 100	17 400	15 400	79,8	52,4	21 700					13,7	
14,0	77,5	52,8	23 700	20 000	17 400	15 400	79,8	52,4	21 700					14,0	
15,2	76,1	52,4	23 300	19 700	17 200	15 200	78,4	52,1	21 500	18 500	16 200			15,2	
16,0	75,2	52,2	23 100	19 500	17 000	15 100	77,5	51,9	21 300	18 400	16 100			16,0	
16,8	74,2	52,0	22 800	19 400	16 900	15 000	76,6	51,6	21 200	18 200	16 100	14 400		16,8	
18,0	72,8	51,6	22 500	19 100	16 700	14 900	75,2	51,2	21 000	18 100	15 900	14 200		18,0	
18,3	72,5	51,5	22 400	19 100	16 700	14 800	74,8	51,1	20 900	18 000	15 900	14 200		18,3	
20,0	70,5	50,9	21 900	18 700	16 400	14 700	72,8	50,5	20 600	17 800	15 700	14 100		20,0	
22,0	68,1	50,1	21 400	18 400	16 200	14 400	70,4	49,7	20 300	17 600	15 600	14 000		22,0	
24,0	65,7	49,2	21 000	18 000	15 900	14 200	67,9	48,8	20 000	17 400	15 400	13 800		24,0	
26,0	63,2	48,1	20 500	17 700	15 600	14 000	65,4	47,8	19 200	17 200	15 300	13 700		26,0	
28,0	60,6	47,0	20 100	17 400	15 400	13 800	62,9	46,6	18 200	17 000	15 100	13 600		28,0	
30,0	58,0	45,8	19 800	17 200	15 200	13 600	60,2	45,4	17 300	16 800	15 000	13 500		30,0	
32,0	55,3	44,4	19 200	16 900	15 000	13 500	57,5	44,0	16 500	16 500	14 900	13 400		32,0	
36,0	49,7	41,1	16 000	15 400	14 500	13 200	51,8	40,7	15 200	15 100	14 700	13 300		36,0	
40,0	43,4	37,2	13 500	13 000	12 600	12 100	45,4	36,7	13 700	13 200	12 800	12 300		40,0	
41,2	41,4	35,7	12 900	12 500	12 100	11 700	43,4	35,2	13 100	12 700	12 300	11 800		41,2	
44,0	36,3	32,1	11 500	11 100	10 800	10 400	38,2	31,5	11 700	11 300	10 900	10 600		44,0	
45,7	32,5	29,2	10 800	10 500	10 100	9 800	34,6	28,9	10 900	10 600	10 200	9 900		45,7	
48,0	27,6	25,4	9 800	9 600	9 300	9 000								48,0	
50,3	21,1	19,9	9 000	8 800	8 500	8 300								50,3	

MLC250 S-2

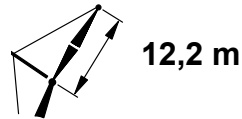
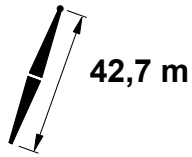

		5°						15°							
				0°	1°	2°	3°			0°	1°	2°	3°		
		m	°	m	kg	kg	kg	kg	°	m	kg	kg	kg	kg	m
12,2	80,1	56,3	24 300						80,7	55,6	21 800				12,2
13,7	78,5	56,0	23 900	20 100	17 400				80,4	55,6	21 800				13,7
14,0	78,2	55,9	23 800	20 000	17 400				79,1	55,2	21 600	18 500			14,0
15,2	76,9	55,6	23 400	19 800	17 200	15 200			78,2	55,0	21 400	18 400			15,2
16,0	76,0	55,4	23 200	19 600	17 100	15 100			77,3	54,8	21 300	18 300	16 100	14 300	16,8
16,8	75,1	55,1	23 000	19 500	17 000	15 000			76,0	54,4	21 100	18 100	15 900	14 200	18,0
18,0	73,8	54,8	22 600	19 200	16 800	14 900			75,7	54,3	21 000	18 100	15 900	14 200	18,3
18,3	73,5	54,7	22 500	19 200	16 700	14 900			73,8	53,8	20 700	17 900	15 800	14 100	20,0
20,0	71,6	54,1	22 100	18 900	16 500	14 700			71,6	53,0	20 400	17 700	15 600	14 000	22,0
22,0	69,4	53,4	21 600	18 500	16 200	14 500			69,3	52,1	20 100	17 400	15 400	13 900	24,0
24,0	67,1	52,5	21 200	18 200	16 000	14 300			66,9	51,2	19 800	17 300	15 300	13 700	26,0
26,0	64,8	51,6	20 800	17 800	15 700	14 100			64,6	50,1	18 900	17 100	15 200	13 600	28,0
28,0	62,4	50,5	20 400	17 600	15 500	13 900			62,1	49,0	18 000	16 900	15 000	13 500	30,0
30,0	60,0	49,4	20 000	17 300	15 300	13 700			59,6	47,7	17 100	16 800	14 900	13 500	32,0
32,0	57,6	48,1	19 000	17 100	15 100	13 600			54,4	44,7	15 700	15 400	14 600	13 300	36,0
36,0	52,4	45,1	15 800	15 200	14 400	13 300			48,7	41,1	13 600	13 100	12 600	12 100	40,0
40,0	46,8	41,6	13 400	12 800	12 300	11 900			42,4	36,6	11 500	11 100	10 700	10 400	44,0
44,0	40,6	37,2	11 400	11 000	10 600	10 200			42,0	36,4	11 400	11 000	10 700	10 300	44,2
44,2	40,2	36,9	11 300	10 900	10 500	10 100			35,1	31,0	9 800	9 500	9 200	8 900	48,0
48,0	33,4	31,6	9 700	9 400	9 100	8 800			33,5	29,7	9 500	9 200	8 900	8 700	48,8
48,8	31,6	30,1	9 400	9 100	8 800	8 600									
51,8	24,8	24,4	8 300	8 100	7 900	7 700									51,8

MLC250 S-2



83 730 kg
+
19 960 kg

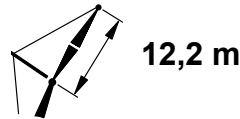
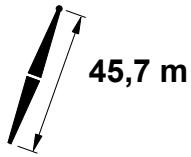

		5°						15°						
			0°	1°	2°	3°			0°	1°	2°	3°		
m	°	m	kg	kg	kg	kg	°	m	kg	kg	kg	kg	m	
12,2	80,6	59,4	24 300	20 100									12,2	
13,7	79,1	59,1	23 900	20 000									13,7	
14,0	78,8	59,0	23 800	20 000									14,0	
15,2	77,6	58,7	23 500	19 800	17 200	15 200	79,6	58,4	21 600	18 400			15,2	
16,0	76,8	58,5	23 300	19 600	17 100	15 200	78,9	58,2	21 400	18 400			16,0	
16,8	75,9	58,3	23 100	19 500	17 000	15 100	78,0	58,0	21 300	18 300	16 000		16,8	
18,0	74,7	58,0	22 700	19 300	16 800	14 900	76,8	57,6	21 100	18 100	15 900		18,0	
18,3	74,4	57,9	22 700	19 200	16 700	14 900	76,5	57,5	21 100	18 100	15 900	14 200	18,3	
19,8	72,8	57,4	22 300	18 900	16 600	14 700	74,9	57,1	20 800	17 900	15 800	14 100	19,8	
20,0	72,6	57,4	22 200	18 900	16 500	14 700	74,7	57,0	20 800	17 900	15 800	14 100	20,0	
22,0	70,5	56,6	21 800	18 600	16 300	14 500	72,6	56,3	20 500	17 700	15 600	14 000	22,0	
24,0	68,4	55,8	21 300	18 300	16 000	14 300	70,4	55,5	20 200	17 500	15 500	13 900	24,0	
26,0	66,2	55,0	20 900	18 000	15 800	14 100	68,3	54,6	20 000	17 300	15 300	13 800	26,0	
28,0	64,0	54,0	20 600	17 700	15 600	14 000	66,0	53,6	19 500	17 100	15 200	13 700	28,0	
30,0	61,8	52,9	20 200	17 400	15 400	13 800	63,8	52,5	18 600	17 000	15 100	13 600	30,0	
32,0	59,5	51,7	18 700	17 200	15 200	13 600	61,4	51,3	17 700	16 900	15 000	13 500	32,0	
36,0	54,7	49,0	15 600	14 900	14 200	13 300	56,6	48,6	15 900	15 200	14 400	13 400	36,0	
40,0	49,6	45,7	13 100	12 500	12 000	11 500	51,5	45,3	13 300	12 800	12 200	11 700	40,0	
44,0	44,0	41,8	11 100	10 600	10 200	9 800	45,9	41,3	11 300	10 800	10 400	10 000	44,0	
45,7	41,4	39,7	10 400	10 000	9 600	9 200	43,1	39,2	10 500	10 200	9 800	9 400	45,7	
48,0	37,8	37,0	9 400	9 100	8 800	8 400	39,6	36,4	9 600	9 200	8 900	8 600	48,0	
51,8	30,9	31,1	8 100	7 800	7 600	7 300	32,5	30,5	8 200	7 900	7 700	7 400	51,8	
52,0	30,6	30,8	8 000	7 800	7 500	7 200							52,0	
54,9	24,1	25,0	7 100	6 900	6 700	6 500							54,9	

MLC250 S-2

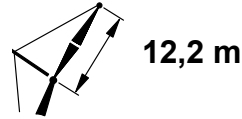
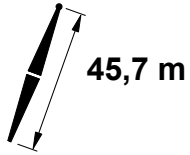
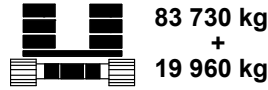
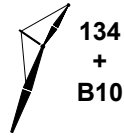

		25°					
		83 730 kg + 19 960 kg					
m	°	m	0° kg	1° kg	2° kg	3° kg	m
12,2							12,2
13,7							13,7
14,0							14,0
15,2							15,2
16,0							16,0
16,8	80,2	57,2	17 900				16,8
18,0	78,9	56,9	17 400				18,0
18,3	78,6	56,8	17 300	16 900	15 200		18,3
19,8	77,0	56,3	16 700	16 400	15 100	13 600	19,8
20,0	76,8	56,2	16 600	16 300	15 100	13 600	20,0
22,0	74,6	55,5	15 900	15 600	15 100	13 500	22,0
24,0	72,4	54,7	15 300	15 000	14 800	13 500	24,0
26,0	70,2	53,8	14 700	14 500	14 300	13 500	26,0
28,0	68,0	52,8	14 200	14 000	13 800	13 500	28,0
30,0	65,7	51,7	13 700	13 500	13 400	13 200	30,0
32,0	63,3	50,5	13 300	13 100	13 000	12 800	32,0
36,0	58,4	47,7	12 500	12 400	12 300	12 200	36,0
40,0	53,1	44,3	11 900	11 800	11 700	11 600	40,0
44,0	47,4	40,2	11 400	11 000	10 600	10 200	44,0
45,7	44,7	38,2	10 700	10 300	9 900	9 500	45,7
48,0							48,0
51,8							51,8
52,0							52,0
54,9							54,9

MLC250 S-2



83 730 kg
+
19 960 kg

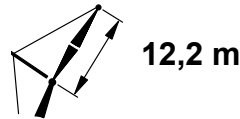
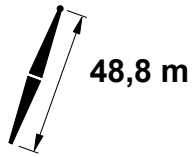

			5°				15°						
			0°	1°	2°	3°			0°	1°	2°	3°	
m	°	m	kg	kg	kg	kg	°	m	kg	kg	kg	kg	m
13,7	79,6	62,2	23 900	20 100									13,7
14,0	79,4	62,1	23 800	20 000									14,0
15,2	78,2	61,9	23 500	19 800	17 200		80,2	61,5	21 600				15,2
16,0	77,4	61,7	23 300	19 700	17 100		79,4	61,3	21 500				16,0
16,8	76,7	61,5	23 100	19 500	17 000	15 000	78,6	61,1	21 300	18 300	16 000		16,8
18,0	75,5	61,2	22 800	19 300	16 800	14 900	77,5	60,8	21 100	18 100	15 900		18,0
18,3	75,2	61,1	22 700	19 200	16 800	14 900	77,2	60,7	21 100	18 100	15 900	14 200	18,3
19,8	73,7	60,6	22 400	19 000	16 600	14 700	75,7	60,3	20 900	17 900	15 800	14 100	19,8
20,0	73,5	60,6	22 400	19 000	16 600	14 700	75,5	60,2	20 800	17 900	15 700	14 100	20,0
22,0	71,5	59,9	21 900	18 600	16 300	14 500	73,5	59,5	20 600	17 700	15 600	14 000	22,0
24,0	69,5	59,1	21 500	18 300	16 100	14 300	71,5	58,8	20 300	17 500	15 500	13 900	24,0
26,0	67,5	58,3	21 100	18 000	15 800	14 100	69,4	57,9	20 100	17 400	15 300	13 700	26,0
28,0	65,4	57,4	20 700	17 800	15 700	14 000	67,3	57,0	19 800	17 200	15 200	13 700	28,0
30,0	63,3	56,4	20 200	17 500	15 500	13 800	65,2	56,0	19 100	17 000	15 100	13 600	30,0
32,0	61,2	55,3	18 600	17 300	15 300	13 700	63,1	54,9	18 300	16 900	15 000	13 500	32,0
36,0	56,7	52,7	15 400	14 600	13 900	13 100	58,6	52,3	15 700	15 000	14 200	13 300	36,0
40,0	52,0	49,7	12 900	12 300	11 800	11 200	53,8	49,3	13 200	12 600	12 000	11 500	40,0
44,0	47,0	46,2	10 900	10 400	10 000	9 600	48,7	45,7	11 100	10 700	10 200	9 800	44,0
48,0	41,5	41,9	9 300	8 900	8 500	8 200	43,2	41,4	9 400	9 100	8 700	8 300	48,0
48,8	40,3	40,9	9 000	8 600	8 300	7 900	41,9	40,3	9 200	8 800	8 400	8 100	48,8
52,0	35,2	36,6	7 900	7 600	7 300	7 000	36,8	36,0	8 000	7 700	7 400	7 100	52,0
54,9	29,9	31,7	7 000	6 800	6 500	6 300	31,6	31,2	7 100	6 800	6 600	6 300	54,9
56,0	27,8	29,8	6 700	6 400	6 200	6 000							56,0
57,9	23,5	25,6	6 100	5 900	5 700	5 500							57,9

MLC250 S-2

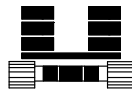

83 730 kg
+
19 960 kg

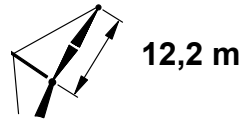
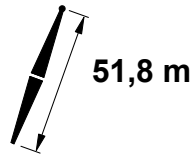

		5°						15°						
	m	°	m	kg	kg	kg	kg	°	m	kg	kg	kg	kg	m
13,7	80,1	65,3	23 900											13,7
14,0	79,9	65,2	23 800											14,0
15,2	78,8	65,0	23 500	19 800	17 100			80,7	64,6	21 600				15,2
16,0	78,0	64,8	23 300	19 600	17 000			79,9	64,5	21 500				16,0
16,8	77,3	64,6	23 100	19 500	16 900	15 000		79,2	64,3	21 400	18 200			16,8
18,0	76,2	64,3	22 900	19 300	16 800	14 900		78,1	64,0	21 200	18 100			18,0
18,3	75,9	64,2	22 800	19 300	16 700	14 900		77,8	63,9	21 200	18 100	15 900	14 200	18,3
19,8	74,5	63,8	22 500	19 000	16 600	14 700		76,4	63,4	20 900	18 000	15 800	14 100	19,8
20,0	74,3	63,8	22 400	19 000	16 500	14 700		76,2	63,4	20 900	17 900	15 700	14 100	20,0
21,3	73,1	63,3	22 100	18 800	16 400	14 600		75,0	63,0	20 700	17 800	15 700	14 000	21,3
22,0	72,5	63,1	22 000	18 700	16 300	14 500		74,3	62,7	20 600	17 700	15 600	13 900	22,0
24,0	70,6	62,4	21 600	18 400	16 100	14 300		72,4	62,0	20 400	17 600	15 500	13 900	24,0
26,0	68,6	61,6	21 200	18 100	15 900	14 200		70,5	61,2	20 100	17 400	15 300	13 700	26,0
28,0	66,7	60,7	20 900	17 900	15 700	14 000		68,5	60,4	19 900	17 200	15 200	13 700	28,0
30,0	64,7	59,8	20 100	17 600	15 500	13 900		66,5	59,4	19 600	17 100	15 100	13 600	30,0
32,0	62,7	58,8	18 300	17 300	15 300	13 700		64,5	58,4	18 800	17 000	15 000	13 500	32,0
36,0	58,5	56,4	15 200	14 400	13 600	12 900		60,3	56,0	15 500	14 700	14 000	13 100	36,0
40,0	54,2	53,6	12 700	12 100	11 500	10 900		55,9	53,2	13 000	12 400	11 800	11 200	40,0
44,0	49,5	50,3	10 700	10 200	9 700	9 300		51,2	49,9	10 900	10 400	9 900	9 500	44,0
48,0	44,5	46,5	9 000	8 600	8 300	7 900		46,2	46,0	9 200	8 800	8 400	8 100	48,0
50,3	41,4	43,8	8 200	7 900	7 500	7 200		43,0	43,2	8 400	8 100	7 700	7 400	50,3
52,0	39,0	41,8	7 600	7 300	7 000	6 700		40,6	41,2	7 800	7 500	7 200	6 800	52,0
56,0	32,8	36,0	6 500	6 200	5 900	5 700		34,2	35,4	6 600	6 300	6 100	5 800	56,0
56,4	32,0	35,3	6 400	6 100	5 900	5 600		33,5	34,7	6 500	6 200	6 000	5 700	56,4
60,0	25,1	28,5	5 400	5 200	5 000	4 800								60,0
61,0	22,9	26,2	5 200	5 000	4 800	4 600								61,0

MLC250 S-2

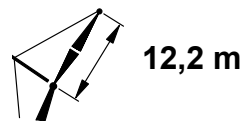
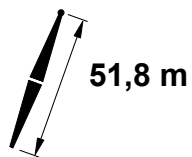

		25°					
		83 730 kg + 19 960 kg					
m	°	m	0° kg	1° kg	2° kg	3° kg	m
13,7							13,7
14,0							14,0
15,2							15,2
16,0							16,0
16,8							16,8
18,0							18,0
18,3	79,7	63,1	17 700	17 100			18,3
19,8	78,3	62,7	17 200	16 800	15 100		19,8
20,0	78,1	62,6	17 100	16 700	15 100		20,0
21,3	76,8	62,2	16 700	16 300	15 000	13 500	21,3
22,0	76,2	62,0	16 400	16 100	15 000	13 500	22,0
24,0	74,2	61,2	15 800	15 500	15 000	13 500	24,0
26,0	72,3	60,4	15 300	15 000	14 700	13 400	26,0
28,0	70,3	59,5	14 700	14 500	14 300	13 400	28,0
30,0	68,3	58,6	14 300	14 100	13 900	13 400	30,0
32,0	66,2	57,5	13 800	13 600	13 500	13 300	32,0
36,0	61,9	55,1	13 100	12 900	12 800	12 600	36,0
40,0	57,5	52,2	12 400	12 300	12 000	11 400	40,0
44,0	52,7	48,9	11 200	10 600	10 200	9 700	44,0
48,0	47,5	44,9	9 400	9 000	8 600	8 200	48,0
50,3	44,3	42,2	8 500	8 200	7 800	7 500	50,3
52,0							52,0
56,0							56,0
56,4							56,4
60,0							60,0
61,0							61,0

MLC250 S-2

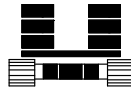
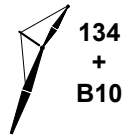

83 730 kg
+
19 960 kg

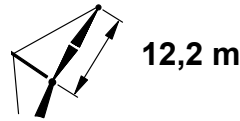
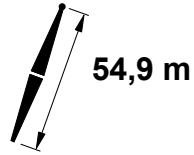

		5°						15°						
	m	°	m	kg	kg	kg	kg	°	m	kg	kg	kg	kg	m
13,7	80,6	68,4	23 900											13,7
14,0	80,3	68,4	23 800											14,0
15,2	79,3	68,1	23 500	19 700										15,2
16,0	78,6	67,9	23 300	19 600										16,0
16,8	77,9	67,7	23 200	19 500	16 900	15 000		79,7	67,4	21 300	18 200			16,8
18,0	76,8	67,5	22 900	19 300	16 700	14 800	78,7	67,1	21 200	18 100				18,0
18,3	76,6	67,4	22 800	19 200	16 700	14 800	78,4	67,0	21 100	18 100	15 800			18,3
19,8	75,2	67,0	22 500	19 000	16 500	14 700	77,0	66,6	20 900	17 900	15 700	14 000		19,8
20,0	75,1	66,9	22 500	19 000	16 500	14 700	76,9	66,6	20 900	17 900	15 700	14 000		20,0
21,3	73,9	66,5	22 200	18 800	16 400	14 500	75,7	66,2	20 700	17 800	15 600	13 900		21,3
22,0	73,3	66,3	22 100	18 700	16 300	14 500	75,1	65,9	20 600	17 700	15 600	13 900		22,0
24,0	71,5	65,6	21 700	18 400	16 100	14 300	73,3	65,3	20 400	17 500	15 500	13 800		24,0
26,0	69,7	64,9	21 300	18 100	15 900	14 200	71,4	64,5	20 200	17 400	15 300	13 700		26,0
28,0	67,8	64,1	21 000	17 900	15 700	14 000	69,6	63,7	20 000	17 200	15 200	13 600		28,0
30,0	65,9	63,2	20 000	17 700	15 500	13 900	67,7	62,8	19 800	17 100	15 100	13 600		30,0
32,0	64,0	62,2	18 200	17 100	15 300	13 700	65,8	61,8	18 600	17 000	15 000	13 500		32,0
36,0	60,1	60,0	15 000	14 200	13 400	12 600	61,8	59,6	15 400	14 500	13 700	12 900		36,0
40,0	56,0	57,4	12 500	11 900	11 200	10 600	57,7	56,9	12 800	12 200	11 500	10 900		40,0
44,0	51,8	54,3	10 500	10 000	9 500	9 000	53,4	53,9	10 800	10 200	9 700	9 200		44,0
48,0	47,2	50,8	8 900	8 400	8 000	7 600	48,8	50,3	9 100	8 600	8 200	7 800		48,0
52,0	42,2	46,6	7 500	7 100	6 800	6 500	43,8	46,1	7 600	7 300	6 900	6 600		52,0
53,3	40,4	44,9	7 100	6 700	6 400	6 100	41,9	44,3	7 200	6 900	6 600	6 300		53,3
56,0	36,7	41,5	6 300	6 000	5 700	5 500	38,2	40,9	6 400	6 100	5 900	5 600		56,0
59,4	31,2	36,1	5 400	5 200	4 900	4 700	32,7	35,5	5 500	5 300	5 000	4 800		59,4
60,0	30,3	35,3	5 300	5 000	4 800	4 600								60,0
64,0	22,3	26,8	4 300	4 200	4 000	3 800								64,0

MLC250 S-2

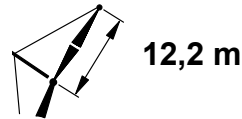
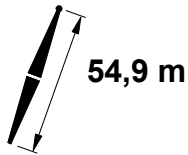
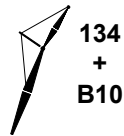

				25°					
				0°	1°	2°	3°		
				kg	kg	kg	kg		
				kg	kg	kg	kg		
				kg	kg	kg	kg		
				kg	kg	kg	kg		
				kg	kg	kg	kg		
				kg	kg	kg	kg		
				kg	kg	kg	kg		
				kg	kg	kg	kg		
				kg	kg	kg	kg		
				kg	kg	kg	kg		
				kg	kg	kg	kg		
				kg	kg	kg	kg		
				kg	kg	kg	kg		
				kg	kg	kg	kg		
				kg	kg	kg	kg		
				kg	kg	kg	kg		
				kg	kg	kg	kg		
				kg	kg	kg	kg		
				kg	kg	kg	kg		
				kg	kg	kg	kg		
				kg	kg	kg	kg		
				kg	kg	kg	kg		
				kg	kg	kg	kg		
				kg	kg	kg	kg		
				kg	kg	kg	kg		
				kg	kg	kg	kg		
				kg	kg	kg	kg		
				kg	kg	kg	kg		
				kg	kg	kg	kg		
				kg	kg	kg	kg		
				kg	kg	kg	kg		
				kg	kg	kg	kg		
				kg	kg	kg	kg		
				kg	kg	kg	kg		
				kg	kg	kg	kg		
				kg	kg	kg	kg		
				kg	kg	kg	kg		
				kg	kg	kg	kg		
				kg	kg	kg	kg		
				kg	kg	kg	kg		
				kg	kg	kg	kg		
				kg	kg	kg	kg		
				kg	kg	kg	kg		
				kg	kg	kg	kg		
				kg	kg	kg	kg		
				kg	kg	kg	kg		
				kg	kg	kg	kg		
				kg	kg	kg	kg		
				kg	kg	kg	kg		
				kg	kg	kg	kg		
				kg	kg	kg	kg		
				kg	kg	kg	kg		
				kg	kg	kg	kg		
				kg	kg	kg	kg		
				kg	kg	kg	kg		
				kg	kg	kg	kg		
				kg	kg	kg	kg		
				kg	kg	kg	kg		
				kg	kg	kg	kg		
				kg	kg	kg	kg		
				kg	kg	kg	kg		
				kg	kg	kg	kg		
				kg	kg	kg	kg		
				kg	kg	kg	kg		
				kg	kg	kg	kg		
				kg	kg	kg	kg		
				kg	kg	kg	kg		
				kg	kg	kg	kg		
				kg	kg	kg	kg		
				kg	kg	kg	kg		
				kg	kg	kg	kg		
				kg	kg	kg	kg		
				kg	kg	kg	kg		
				kg	kg	kg	kg		
				kg	kg	kg	kg		
				kg	kg	kg	kg		
				kg	kg	kg	kg		
				kg	kg	kg	kg		
				kg	kg	kg	kg		
				kg	kg	kg	kg		
				kg	kg	kg	kg		
				kg	kg	kg	kg		
				kg	kg	kg	kg		
				kg	kg	kg	kg		
				kg	kg	kg	kg		
				kg	kg	kg	kg		
				kg	kg	kg	kg		
				kg	kg	kg	kg		

MLC250 S-2

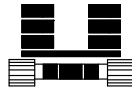
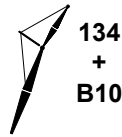

83 730 kg
+
19 960 kg

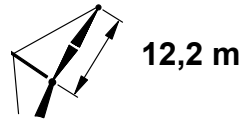
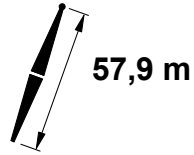

		5°						15°						
			0°	1°	2°	3°			0°	1°	2°	3°		
m	°	m	kg	kg	kg	kg	°	m	kg	kg	kg	kg	m	
13,7	81,0	71,5	23 800										13,7	
14,0	80,8	71,5	23 800										14,0	
15,2	79,8	71,2	23 500	19 700									15,2	
16,0	79,1	71,1	23 300	19 500									16,0	
16,8	78,4	70,9	23 200	19 400	16 800		80,2	70,5	21 300				16,8	
18,0	77,4	70,6	22 900	19 200	16 700		79,2	70,2	21 200	18 000	15 800		18,0	
18,3	77,2	70,5	22 800	19 200	16 600	14 700	78,9	70,2	21 100	17 900	15 700	14 000	18,3	
19,8	75,9	70,1	22 500	19 000	16 500	14 600	77,6	69,8	20 900	17 900	15 700	14 000	19,8	
20,0	75,7	70,1	22 500	19 000	16 500	14 600	77,5	69,7	20 900	17 900	15 700	14 000	20,0	
21,3	74,6	69,7	22 200	18 800	16 300	14 500	76,3	69,3	20 700	17 700	15 600	13 900	21,3	
22,0	74,0	69,5	22 100	18 700	16 200	14 400	75,7	69,1	20 700	17 700	15 500	13 900	22,0	
22,9	73,3	69,2	21 900	18 500	16 200	14 400	75,0	68,8	20 500	17 600	15 500	13 800	22,9	
24,0	72,3	68,9	21 700	18 400	16 100	14 300	74,0	68,5	20 400	17 500	15 400	13 800	24,0	
26,0	70,6	68,2	21 400	18 200	15 900	14 100	72,3	67,8	20 200	17 400	15 300	13 700	26,0	
28,0	68,8	67,4	21 000	17 900	15 700	14 000	70,5	67,0	20 000	17 200	15 200	13 600	28,0	
30,0	67,1	66,5	19 800	17 700	15 500	13 800	68,7	66,1	19 800	17 100	15 100	13 500	30,0	
32,0	65,2	65,6	17 900	16 800	15 400	13 700	66,9	65,2	18 400	17 000	15 000	13 500	32,0	
36,0	61,6	63,5	14 800	13 900	13 000	12 300	63,2	63,1	15 100	14 300	13 400	12 600	36,0	
40,0	57,7	61,1	12 300	11 600	10 900	10 300	59,3	60,6	12 600	11 900	11 200	10 600	40,0	
44,0	53,7	58,2	10 200	9 700	9 200	8 600	55,3	57,8	10 500	10 000	9 400	8 900	44,0	
48,0	49,5	54,9	8 600	8 100	7 700	7 300	51,0	54,5	8 800	8 400	7 900	7 500	48,0	
52,0	44,9	51,1	7 200	6 800	6 500	6 100	46,4	50,6	7 400	7 000	6 700	6 300	52,0	
54,9	41,4	47,9	6 400	6 000	5 700	5 400	42,9	47,3	6 500	6 200	5 900	5 600	54,9	
56,0	40,0	46,6	6 000	5 700	5 400	5 100	41,4	46,0	6 200	5 900	5 600	5 300	56,0	
60,0	34,5	41,1	5 000	4 700	4 500	4 300	35,8	40,5	5 100	4 900	4 600	4 400	60,0	
62,5	30,4	36,8	4 400	4 200	4 000	3 800	31,9	36,3	4 500	4 300	4 100	3 900	62,5	
64,0	28,0	34,2	4 100	3 900	3 700	3 500							64,0	
67,1	21,8	27,3	3 500	3 300	3 100	3 000							67,1	

MLC250 S-2

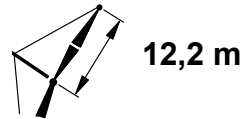
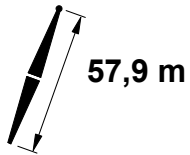
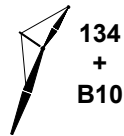

		25°					
		83 730 kg + 19 960 kg					
m	°	m	0° kg	1° kg	2° kg	3° kg	m
13,7							13,7
14,0							14,0
15,2							15,2
16,0							16,0
16,8							16,8
18,0							18,0
18,3	80,7	69,4	18 100				18,3
19,8	79,3	69,0	17 600	17 000			19,8
20,0	79,2	68,9	17 500	16 900			20,0
21,3	78,0	68,5	17 100	16 700	14 900		21,3
22,0	77,4	68,3	16 900	16 500	14 900		22,0
22,9	76,7	68,0	16 600	16 300	14 900	13 400	22,9
24,0	75,7	67,7	16 300	16 000	14 900	13 400	24,0
26,0	73,9	67,0	15 700	15 400	14 800	13 300	26,0
28,0	72,1	66,2	15 200	15 000	14 700	13 300	28,0
30,0	70,3	65,3	14 800	14 500	14 300	13 300	30,0
32,0	68,5	64,4	14 300	14 100	13 900	13 300	32,0
36,0	64,7	62,2	13 600	13 400	13 200	12 800	36,0
40,0	60,8	59,7	12 800	12 200	11 500	10 900	40,0
44,0	56,7	56,8	10 800	10 200	9 700	9 100	44,0
48,0	52,3	53,4	9 000	8 600	8 100	7 700	48,0
52,0	47,7	49,5	7 600	7 200	6 800	6 500	52,0
54,9	44,1	46,2	6 600	6 300	6 000	5 700	54,9
56,0							56,0
60,0							60,0
62,5							62,5
64,0							64,0
67,1							67,1

MLC250 S-2

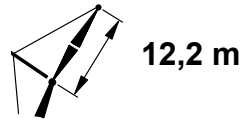
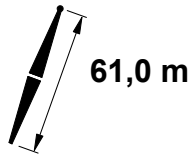

		5°						15°						
			0°	1°	2°	3°			0°	1°	2°	3°		
	m	°	kg	kg	kg	kg	°	m	kg	kg	kg	kg	m	
15,2	80,2	74,3	23 400										15,2	
16,0	79,6	74,2	23 300										16,0	
16,8	78,9	74,0	23 100	19 300	16 700		80,6	73,6	21 300				16,8	
18,0	78,0	73,7	22 900	19 200	16 600		79,6	73,4	21 100				18,0	
18,3	77,7	73,7	22 800	19 100	16 600	14 700	79,4	73,3	21 100	17 900			18,3	
19,8	76,5	73,3	22 500	18 900	16 400	14 500	78,2	72,9	20 900	17 800	15 600		19,8	
20,0	76,3	73,2	22 500	18 900	16 400	14 500	78,0	72,9	20 900	17 800	15 600		20,0	
21,3	75,3	72,9	22 200	18 700	16 300	14 400	76,9	72,5	20 700	17 700	15 500	13 800	21,3	
22,0	74,7	72,7	22 100	18 600	16 200	14 400	76,4	72,3	20 600	17 600	15 500	13 800	22,0	
22,9	74,0	72,4	21 900	18 500	16 100	14 300	75,6	72,0	20 500	17 600	15 400	13 800	22,9	
24,0	73,1	72,1	21 700	18 400	16 000	14 200	74,7	71,7	20 400	17 500	15 400	13 700	24,0	
26,0	71,4	71,4	21 400	18 100	15 800	14 100	73,1	71,0	20 200	17 300	15 200	13 700	26,0	
28,0	69,8	70,7	21 000	17 900	15 700	13 900	71,4	70,3	20 000	17 200	15 100	13 600	28,0	
30,0	68,1	69,8	19 700	17 700	15 500	13 800	69,7	69,5	19 800	17 100	15 100	13 500	30,0	
32,0	66,4	69,0	17 700	16 500	15 300	13 700	67,9	68,6	18 200	17 000	15 000	13 400	32,0	
36,0	62,9	67,0	14 600	13 600	12 800	12 000	64,4	66,6	15 000	14 000	13 200	12 300	36,0	
40,0	59,2	64,7	12 100	11 300	10 600	10 000	60,8	64,3	12 400	11 700	11 000	10 300	40,0	
44,0	55,5	62,0	10 100	9 500	8 900	8 400	57,0	61,6	10 400	9 800	9 200	8 600	44,0	
48,0	51,5	58,9	8 400	7 900	7 500	7 000	53,0	58,5	8 700	8 200	7 700	7 200	48,0	
52,0	47,3	55,4	7 000	6 600	6 200	5 900	48,8	54,9	7 200	6 800	6 400	6 100	52,0	
56,0	42,8	51,3	5 800	5 500	5 200	4 900	44,2	50,7	6 000	5 700	5 300	5 000	56,0	
57,9	40,5	48,9	5 300	5 000	4 700	4 500	41,8	48,4	5 500	5 200	4 900	4 600	57,9	
60,0	37,9	46,4	4 800	4 500	4 300	4 000	39,2	45,8	4 900	4 700	4 400	4 100	60,0	
64,0	32,3	40,5	3 900	3 700	3 500	3 300	33,5	39,8	4 000	3 800	3 600	3 300	64,0	
68,0	25,6	33,0	3 100	2 900	2 800	2 600							68,0	
70,1	21,3	27,9	2 700	2 600	2 400	2 300							70,1	

MLC250 S-2

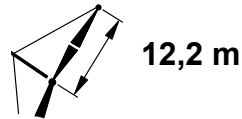
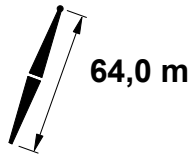

		5°						15°						
	m	°	m	kg	kg	kg	kg	°	m	kg	kg	kg	kg	m
15,2	80,6	77,4	23 300											15,2
16,0	80,0	77,3	23 200											16,0
16,8	79,4	77,1	23 000	19 200				81,0	76,8	21 200				16,8
18,0	78,5	76,9	22 800	19 100				80,0	76,5	21 000				18,0
18,3	78,2	76,8	22 700	19 000	16 500			79,8	76,4	21 000	17 900			18,3
19,8	77,1	76,4	22 500	18 800	16 300	14 500		78,6	76,1	20 800	17 700	15 500		19,8
20,0	76,9	76,4	22 400	18 800	16 300	14 500		78,5	76,0	20 800	17 700	15 500		20,0
21,3	75,9	76,0	22 200	18 700	16 200	14 400		77,5	75,7	20 700	17 600	15 400	13 800	21,3
22,0	75,4	75,9	22 100	18 600	16 100	14 300		76,9	75,5	20 600	17 600	15 400	13 700	22,0
22,9	74,6	75,6	21 900	18 500	16 100	14 200		76,2	75,2	20 500	17 500	15 300	13 700	22,9
24,0	73,8	75,3	21 700	18 300	16 000	14 200		75,4	74,9	20 400	17 400	15 300	13 700	24,0
26,0	72,2	74,6	21 400	18 100	15 800	14 000		73,8	74,2	20 200	17 300	15 200	13 600	26,0
28,0	70,6	73,9	21 000	17 900	15 600	13 900		72,2	73,5	20 000	17 200	15 100	13 500	28,0
30,0	69,0	73,1	19 500	17 600	15 500	13 800		70,5	72,8	19 600	17 100	15 000	13 500	30,0
32,0	67,4	72,3	17 500	16 300	15 100	13 600		68,9	71,9	18 000	16 700	14 900	13 400	32,0
36,0	64,0	70,4	14 300	13 400	12 500	11 600		65,6	70,0	14 800	13 800	12 900	12 000	36,0
40,0	60,6	68,2	11 800	11 100	10 400	9 700		62,1	67,8	12 200	11 400	10 700	10 000	40,0
44,0	57,1	65,7	9 800	9 200	8 600	8 100		58,5	65,3	10 100	9 500	8 900	8 400	44,0
48,0	53,3	62,8	8 200	7 700	7 200	6 700		54,8	62,4	8 400	7 900	7 400	7 000	48,0
52,0	49,4	59,5	6 800	6 400	6 000	5 600		50,9	59,1	7 000	6 600	6 200	5 800	52,0
56,0	45,3	55,7	5 600	5 300	4 900	4 600		46,7	55,2	5 800	5 400	5 100	4 800	56,0
59,4	41,4	51,9	4 700	4 400	4 100	3 900		42,8	51,4	4 900	4 600	4 300	4 000	59,4
60,0	40,8	51,3	4 600	4 300	4 000	3 700		42,1	50,7	4 700	4 400	4 200	3 900	60,0
64,0	35,8	46,1	3 700	3 400	3 200	3 000		37,1	45,4	3 800	3 600	3 300	3 100	64,0
67,1	31,5	41,2	3 100	2 900	2 700	2 500		32,8	40,6	3 200	3 000	2 800	2 500	67,1
68,0	30,2	39,7	2 900	2 700	2 500	2 300								68,0
71,6	24,0	32,3	2 200	2 100	1 900	1 800								71,6

MLC250 S-2

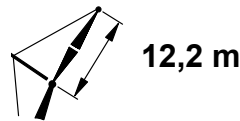
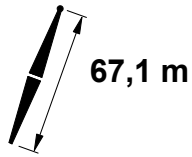

		5°						15°						
			0°	1°	2°	3°			0°	1°	2°	3°		
m	°	m	kg	kg	kg	kg	°	m	kg	kg	kg	kg	m	
15,2	80,9	80,5	23 200										15,2	
16,0	80,4	80,4	23 000										16,0	
16,8	79,8	80,2	22 900	19 100									16,8	
18,0	78,9	80,0	22 700	18 900									18,0	
18,3	78,7	79,9	22 600	18 900	16 400		80,2	79,5	20 900				18,3	
19,8	77,6	79,6	22 300	18 700	16 200	14 300	79,1	79,2	20 800	17 600			19,8	
20,0	77,4	79,5	22 300	18 700	16 200	14 300	78,9	79,2	20 800	17 600			20,0	
21,3	76,4	79,2	22 100	18 600	16 100	14 200	78,0	78,8	20 600	17 500	15 300	13 600	21,3	
22,0	75,9	79,0	22 000	18 500	16 000	14 200	77,4	78,6	20 600	17 500	15 300	13 600	22,0	
22,9	75,2	78,8	21 800	18 400	16 000	14 100	76,8	78,4	20 500	17 400	15 200	13 600	22,9	
24,0	74,4	78,5	21 700	18 300	15 900	14 100	75,9	78,1	20 400	17 300	15 200	13 600	24,0	
24,4	74,1	78,3	21 600	18 200	15 800	14 100	75,6	77,9	20 300	17 300	15 200	13 500	24,4	
26,0	72,9	77,8	21 400	18 000	15 700	14 000	74,4	77,5	20 200	17 200	15 100	13 500	26,0	
28,0	71,4	77,2	20 900	17 800	15 500	13 800	72,9	76,8	20 000	17 100	15 000	13 400	28,0	
30,0	69,8	76,4	19 300	17 500	15 400	13 700	71,3	76,0	19 500	17 000	14 900	13 400	30,0	
32,0	68,3	75,6	17 300	16 000	14 800	13 600	69,8	75,2	17 800	16 500	14 900	13 300	32,0	
36,0	65,1	73,8	14 100	13 100	12 200	11 300	66,6	73,4	14 600	13 600	12 600	11 700	36,0	
40,0	61,9	71,7	11 600	10 900	10 100	9 400	63,3	71,3	12 000	11 200	10 500	9 700	40,0	
44,0	58,5	69,4	9 600	9 000	8 400	7 800	59,9	68,9	10 000	9 300	8 700	8 100	44,0	
48,0	55,0	66,6	8 000	7 500	6 900	6 500	56,4	66,2	8 300	7 700	7 200	6 700	48,0	
52,0	51,3	63,6	6 600	6 100	5 700	5 300	52,7	63,1	6 800	6 400	6 000	5 500	52,0	
56,0	47,5	60,0	5 400	5 000	4 700	4 300	48,8	59,5	5 600	5 200	4 900	4 500	56,0	
60,0	43,3	55,9	4 400	4 100	3 800	3 500	44,6	55,4	4 600	4 200	3 900	3 600	60,0	
62,5	40,5	53,0	3 800	3 600	3 300	3 000	41,8	52,4	4 000	3 700	3 400	3 200	62,5	
64,0	38,8	51,2	3 500	3 200	3 000	2 700	40,1	50,6	3 600	3 400	3 100	2 900	64,0	
68,0	33,9	45,6	2 700	2 500	2 300	2 100	35,0	44,9	2 800	2 600	2 400	2 200	68,0	
68,6	33,0	44,6	2 600	2 400	2 200	2 000	34,2	43,9	2 700	2 500	2 300	2 100	68,6	
70,1	30,8	42,0	2 300	2 100	1 900		32,1	41,4	2 400	2 200	2 000	1 800	70,1	
71,6	28,6	39,3	2 100	1 900									71,6	
72,0	28,1	38,7	2 000										72,0	
73,2	26,2	36,3	1 800										73,2	

MLC250 S-2



83 730 kg
+
19 960 kg

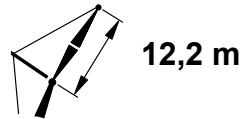
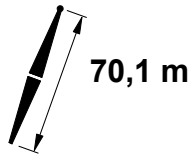

		5°					15°						
			0°	1°	2°	3°			0°	1°	2°	3°	
m	°	m	kg	kg	kg	kg	°	m	kg	kg	kg	kg	m
16,8	80,2	83,3	22 800										16,8
18,0	79,3	83,1	22 500										18,0
18,3	79,1	83,0	22 500	18 800			80,6	82,7	20 800				18,3
19,8	78,0	82,7	22 200	18 600	16 100		79,5	82,3	20 700	17 500			19,8
20,0	77,9	82,7	22 200	18 600	16 100		79,4	82,3	20 700	17 500			20,0
21,3	77,0	82,3	22 000	18 400	16 000	13 900	78,4	82,0	20 500	17 400	15 200		21,3
22,0	76,5	82,2	21 900	18 400	15 900	13 900	77,9	81,8	20 500	17 400	15 200		22,0
22,9	75,8	81,9	21 800	18 300	15 800	13 900	77,3	81,5	20 400	17 300	15 200	13 400	22,9
24,0	75,0	81,6	21 600	18 100	15 700	13 900	76,5	81,2	20 300	17 300	15 100	13 400	24,0
24,4	74,7	81,5	21 500	18 100	15 700	13 900	76,2	81,1	20 200	17 200	15 100	13 400	24,4
26,0	73,6	81,0	21 300	17 900	15 600	13 800	75,0	80,7	20 100	17 100	15 000	13 400	26,0
28,0	72,1	80,4	20 700	17 800	15 500	13 700	73,5	80,0	19 900	17 000	14 900	13 300	28,0
30,0	70,6	79,7	19 000	17 200	15 300	13 600	72,1	79,3	19 300	16 900	14 900	13 300	30,0
32,0	69,1	78,9	17 100	15 700	14 500	13 400	70,6	78,5	17 600	16 200	14 800	13 200	32,0
36,0	66,1	77,2	13 900	12 800	11 900	11 000	67,5	76,8	14 400	13 300	12 300	11 400	36,0
40,0	63,0	75,2	11 400	10 600	9 800	9 100	64,4	74,8	11 800	10 900	10 200	9 400	40,0
44,0	59,8	72,9	9 400	8 700	8 100	7 500	61,2	72,5	9 700	9 000	8 400	7 800	44,0
48,0	56,5	70,4	7 700	7 200	6 600	6 100	57,8	69,9	8 000	7 400	6 900	6 400	48,0
52,0	53,0	67,5	6 300	5 900	5 400	5 000	54,4	67,0	6 600	6 100	5 700	5 200	52,0
56,0	49,4	64,1	5 100	4 700	4 400	4 000	50,7	63,6	5 400	5 000	4 600	4 200	56,0
60,0	45,6	60,4	4 100	3 800	3 500	3 200	46,8	59,8	4 300	4 000	3 600	3 300	60,0
64,0	41,5	56,0	3 200	2 900	2 700	2 400	42,7	55,4	3 400	3 100	2 800	2 600	64,0
67,1	38,0	52,1	2 600	2 400	2 100	1 900	39,2	51,5	2 800	2 500	2 300	2 000	67,1
68,0	37,0	51,0	2 400	2 200	2 000		38,1	50,3	2 600	2 300	2 100	1 900	68,0
68,6	36,2	50,1	2 300	2 100	1 900		37,4	49,5	2 500	2 200	2 000	1 800	68,6
70,1	34,3	47,8	2 100	1 800			35,5	47,1	2 200	1 900			70,1
71,6	32,4	45,5	1 800				33,5	44,8	1 900				71,6

MLC250 S-2

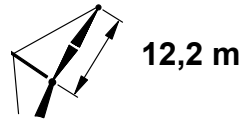
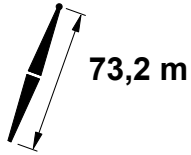
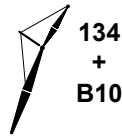

		5°						15°									
		0°				1°		0°				1°					
		kg				kg		kg				kg		m			
m		°		m		kg		°		m		kg		kg		m	
16,8	80,6	86,4	22 600														16,8
18,0	79,7	86,2	22 400														18,0
18,3	79,5	86,1	22 300	18 600				80,9	85,8	20 700							18,3
19,8	78,5	85,8	22 100	18 400	15 900			79,9	85,4	20 500	17 400						19,8
20,0	78,3	85,8	22 100	18 400	15 900			79,8	85,4	20 500	17 400						20,0
21,3	77,4	85,5	21 900	18 300	15 800	12 600		78,9	85,1	20 400	17 300	15 100					21,3
22,0	77,0	85,3	21 800	18 200	15 800	12 500		78,4	84,9	20 400	17 300	15 100					22,0
22,9	76,3	85,1	21 600	18 100	15 700	12 500		77,7	84,7	20 300	17 200	15 000	12 100				22,9
24,0	75,6	84,8	21 500	18 000	15 600	12 500		77,0	84,4	20 200	17 100	15 000	12 000				24,0
24,4	75,3	84,7	21 400	18 000	15 600	12 500		76,7	84,3	20 200	17 100	15 000	12 000				24,4
25,9	74,2	84,2	21 200	17 800	15 500	12 500		75,6	83,9	20 000	17 000	14 900	12 000				25,9
26,0	74,2	84,2	21 200	17 800	15 500	12 500		75,6	83,8	20 000	17 000	14 900	12 000				26,0
28,0	72,8	83,6	20 600	17 600	15 300	12 400		74,2	83,2	19 800	16 900	14 800	12 000				28,0
30,0	71,3	82,9	18 800	17 000	15 200	12 400		72,7	82,5	19 200	16 800	14 700	11 900				30,0
32,0	69,9	82,2	16 900	15 500	14 200	12 300		71,3	81,8	17 400	16 000	14 700	11 900				32,0
36,0	67,0	80,5	13 700	12 600	11 600	10 700		68,4	80,1	14 200	13 100	12 100	11 100				36,0
40,0	64,0	78,6	11 200	10 300	9 500	8 800		65,4	78,2	11 600	10 700	9 900	9 100				40,0
44,0	61,0	76,5	9 200	8 500	7 800	7 200		62,3	76,1	9 500	8 800	8 100	7 500				44,0
48,0	57,8	74,0	7 500	6 900	6 400	5 900		59,2	73,6	7 800	7 200	6 700	6 100				48,0
52,0	54,6	71,3	6 100	5 600	5 200	4 700		55,9	70,8	6 400	5 900	5 400	5 000				52,0
56,0	51,2	68,2	4 900	4 500	4 100	3 800		52,4	67,7	5 200	4 800	4 400	4 000				56,0
60,0	47,6	64,6	3 900	3 600	3 200	2 900		48,8	64,1	4 100	3 800	3 400	3 100				60,0
64,0	43,8	60,6	3 000	2 700	2 400	2 200		45,0	60,0	3 200	2 900	2 600	2 300				64,0
65,5	42,2	58,8	2 700	2 400	2 200	1 900		43,4	58,3	2 900	2 600	2 300	2 100				65,5
67,1	40,6	57,0	2 400	2 200	1 900			41,8	56,5	2 600	2 300	2 000	1 800				67,1
68,0	39,7	56,0	2 200	2 000				40,8	55,4	2 400	2 100	1 900					68,0
68,6	39,0	55,2	2 100	1 900				40,2	54,6	2 300	2 000	1 800					68,6
70,1	37,3	53,2	1 900					38,5	52,6	2 000							70,1

MLC250 S-2

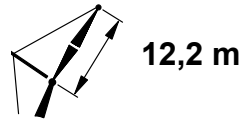
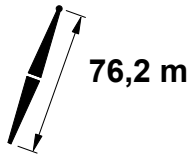

		5°						15°						
			0°	1°	2°	3°			0°	1°	2°	3°		
m	°	m	kg	kg	kg	kg	°	m	kg	kg	kg	kg	m	
16,8	80,9	89,5	22 400										16,8	
18,0	80,1	89,3	22 200										18,0	
18,3	79,9	89,2	22 200	18 400									18,3	
19,8	78,9	88,9	21 900	18 300	15 000		80,2	88,6	20 400				19,8	
20,0	78,7	88,9	21 900	18 300	15 000		80,1	88,5	20 400				20,0	
21,3	77,9	88,6	21 700	18 100	15 000	11 200	79,2	88,2	20 300	17 100			21,3	
22,0	77,4	88,5	21 600	18 000	14 900	11 200	78,8	88,1	20 200	17 100			22,0	
22,9	76,8	88,2	21 500	18 000	14 900	11 200	78,2	87,8	20 200	17 100	14 400		22,9	
24,0	76,1	88,0	21 300	17 900	14 900	11 200	77,4	87,6	20 100	17 000	14 400		24,0	
24,4	75,8	87,8	21 300	17 800	14 900	11 200	77,2	87,5	20 000	17 000	14 400	10 800	24,4	
25,9	74,8	87,4	21 100	17 700	14 800	11 100	76,1	87,0	19 900	16 900	14 300	10 700	25,9	
26,0	74,7	87,4	21 100	17 700	14 800	11 100	76,1	87,0	19 900	16 900	14 300	10 700	26,0	
28,0	73,4	86,8	20 600	17 500	14 700	11 100	74,7	86,4	19 800	16 800	14 300	10 700	28,0	
30,0	72,0	86,1	18 900	17 000	14 700	11 000	73,4	85,7	19 200	16 700	14 200	10 700	30,0	
32,0	70,6	85,4	16 900	15 500	14 200	11 000	72,0	85,0	17 500	16 000	14 200	10 600	32,0	
36,0	67,9	83,9	13 700	12 600	11 600	10 600	69,2	83,4	14 200	13 100	12 000	10 600	36,0	
40,0	65,0	82,0	11 200	10 300	9 500	8 700	66,3	81,6	11 700	10 800	9 900	9 100	40,0	
44,0	62,1	80,0	9 200	8 500	7 800	7 200	63,4	79,6	9 600	8 900	8 200	7 500	44,0	
48,0	59,1	77,6	7 600	7 000	6 400	5 900	60,4	77,2	7 900	7 300	6 700	6 200	48,0	
52,0	56,0	75,0	6 200	5 700	5 200	4 700	57,2	74,6	6 500	5 900	5 500	5 000	52,0	
56,0	52,8	72,1	5 000	4 600	4 200	3 800	54,0	71,6	5 200	4 800	4 400	4 000	56,0	
60,0	49,4	68,7	4 000	3 600	3 300	2 900	50,6	68,2	4 200	3 800	3 500	3 100	60,0	
64,0	45,8	65,0	3 100	2 800	2 500	2 200	47,0	64,5	3 300	2 900	2 600	2 400	64,0	
65,5	44,4	63,3	2 800	2 500	2 200	1 900	45,5	62,8	2 900	2 700	2 400	2 100	65,5	
67,1	42,9	61,7	2 500	2 200	1 900		44,1	61,2	2 600	2 400	2 100	1 800	67,1	
68,0	42,0	60,7	2 300	2 000			43,2	60,1	2 400	2 200	1 900		68,0	
68,6	41,4	60,0	2 200	1 900			42,6	59,4	2 300	2 100	1 800		68,6	
70,1	39,9	58,2	1 900				41,0	57,6	2 100	1 800			70,1	
71,6							39,4	55,7	1 800				71,6	

MLC250 S-2

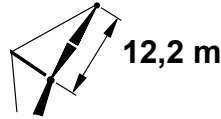
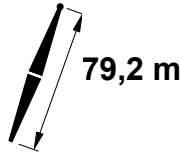
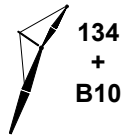

	5°			15°			
	m	°	m	kg	m	°	
18,3	80,2	92,4	21 900	80,6	91,7	20 300	18,3
19,8	79,2	92,1	21 700	80,5	91,6	20 300	19,8
20,0	79,1	92,0	21 700	79,6	91,3	20 100	20,0
21,3	78,3	91,7	21 500	79,2	91,2	20 100	21,3
22,0	77,8	91,6	21 400				22,0
24,0	76,6	91,1	21 200	77,9	90,7	19 900	24,0
26,0	75,3	90,6	20 900	76,6	90,2	19 800	26,0
28,0	74,0	90,0	20 400	75,3	89,6	19 600	28,0
30,0	72,6	89,4	18 700	73,9	89,0	19 000	30,0
32,0	71,3	88,7	16 700	72,6	88,3	17 300	32,0
36,0	68,6	87,2	13 500	69,9	86,7	14 100	36,0
40,0	65,9	85,4	11 000	67,2	85,0	11 500	40,0
44,0	63,1	83,4	9 000	64,4	83,0	9 400	44,0
48,0	60,2	81,2	7 400	61,5	80,8	7 700	48,0
52,0	57,3	78,7	6 000	58,5	78,3	6 300	52,0
56,0	54,2	75,9	4 800	55,4	75,4	5 000	56,0
60,0	51,0	72,8	3 800	52,2	72,3	4 000	60,0
64,0	47,7	69,2	2 900	48,8	68,7	3 100	64,0
68,0	44,1	65,2	2 100	45,3	64,7	2 300	68,0
68,6	43,6	64,6	2 000	44,7	64,0	2 100	68,6
70,1				43,3	62,4	1 900	70,1

MLC250 S-2

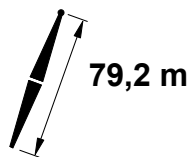

25°				
0°				
m	°	m	kg	m
18,3				18,3
19,8				19,8
20,0				20,0
21,3	80,9	90,5	18 200	21,3
22,0	80,5	90,4	18 000	22,0
24,0	79,2	89,9	17 500	24,0
26,0	77,9	89,4	17 000	26,0
28,0	76,5	88,8	16 600	28,0
30,0	75,2	88,1	16 100	30,0
32,0	73,9	87,4	15 700	32,0
36,0	71,1	85,9	14 500	36,0
40,0	68,4	84,1	11 900	40,0
44,0	65,5	82,1	9 800	44,0
48,0	62,6	79,9	8 000	48,0
52,0	59,6	77,3	6 500	52,0
56,0	56,5	74,4	5 300	56,0
60,0	53,2	71,2	4 200	60,0
64,0	49,8	67,6	3 200	64,0
68,0	46,2	63,5	2 400	68,0
68,6	45,6	62,9	2 300	68,6
70,1	44,1	61,2	2 000	70,1

MLC250 S-2

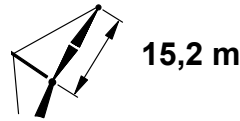
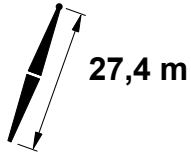
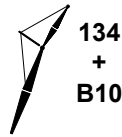

			5°				15°						
			0°	1°	2°	3°			0°	1°	2°	3°	
m	°	m	kg	kg	kg	kg	°	m	kg	kg	kg	kg	m
10,7	79,7	44,2	20 600	17 100									10,7
12,0	77,8	43,8	20 100	16 700									12,0
12,2	77,5	43,8	20 000	16 700	14 400	12 700							12,2
13,7	75,4	43,4	19 400	16 300	14 100	12 400	79,0	43,0	18 000	15 300			13,7
14,0	75,0	43,3	19 300	16 200	14 000	12 400	78,6	42,9	18 000	15 300			14,0
15,2	73,3	42,9	18 900	16 000	13 800	12 200	76,9	42,5	17 600	15 100	13 200	11 700	15,2
16,0	72,2	42,6	18 700	15 800	13 700	12 100	75,7	42,2	17 400	14 900	13 100	11 600	16,0
16,8	71,0	42,3	18 400	15 600	13 500	12 000	74,6	41,9	17 200	14 800	13 000	11 600	16,8
18,0	69,3	41,8	18 100	15 300	13 300	11 800	72,8	41,5	16 800	14 600	12 800	11 400	18,0
18,3	68,9	41,7	18 000	15 300	13 300	11 800	72,4	41,3	16 800	14 600	12 800	11 400	18,3
20,0	66,4	40,9	17 500	14 900	13 000	11 600	69,9	40,6	16 300	14 300	12 600	11 200	20,0
22,0	63,3	39,9	16 900	14 500	12 800	11 400	66,8	39,5	15 500	14 100	12 400	11 100	22,0
24,0	60,2	38,7	16 300	14 200	12 500	11 100	63,7	38,3	14 500	13 800	12 200	11 000	24,0
26,0	57,0	37,4	15 800	13 900	12 200	10 900	60,4	37,0	13 600	13 500	12 000	10 800	26,0
28,0	53,7	35,9	15 300	13 600	12 000	10 700	57,0	35,5	12 800	12 700	11 900	10 700	28,0
30,0	50,1	34,2	14 500	13 300	11 800	10 600	53,5	33,8	12 100	12 000	11 800	10 600	30,0
32,0	46,4	32,3	13 600	13 000	11 600	10 400	49,7	31,8	11 500	11 400	11 300	10 500	32,0
35,1	40,1	28,7	12 500	12 300	11 400	10 200	43,2	28,2	10 700	10 700	10 600	10 300	35,1
36,0	38,1	27,6	12 100	12 000	11 300	10 200	41,2	27,0	10 400	10 400	10 300	10 200	36,0
39,6	28,6	21,5	11 000	10 900	10 800	10 100	31,5	20,9	9 700	9 700	9 700	9 600	39,6
40,0	27,6	20,9	10 900	10 800	10 800	10 000							40,0
41,2	23,7	18,3	10 600	10 600	10 500	10 000							41,2

MLC250 S-2

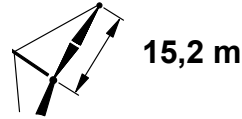
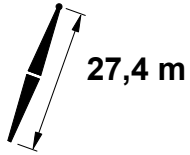
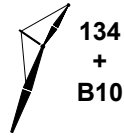

		25°					
		83 730 kg + 19 960 kg					
m	°	m	0° kg	1° kg	2° kg	3° kg	m
10,7							10,7
12,0							12,0
12,2							12,2
13,7							13,7
14,0							14,0
15,2	80,5	41,7	14 700				15,2
16,0	79,4	41,5	14 300				16,0
16,8	78,2	41,1	13 900	13 800	12 400		16,8
18,0	76,4	40,7	13 400	13 200	12 300		18,0
18,3	76,0	40,5	13 200	13 100	12 300	11 000	18,3
20,0	73,4	39,7	12 500	12 400	12 100	10 900	20,0
22,0	70,3	38,7	11 800	11 700	11 500	10 900	22,0
24,0	67,0	37,5	11 200	11 100	10 900	10 700	24,0
26,0	63,7	36,1	10 600	10 500	10 400	10 200	26,0
28,0	60,2	34,5	10 100	10 000	9 900	9 800	28,0
30,0	56,5	32,8	9 700	9 600	9 500	9 400	30,0
32,0	52,6	30,8	9 300	9 300	9 200	9 100	32,0
35,1	46,0	27,1	8 800	8 800	8 700	8 700	35,1
36,0							36,0
39,6							39,6
40,0							40,0
41,2							41,2

MLC250 S-2

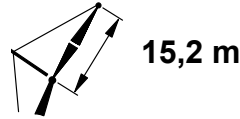
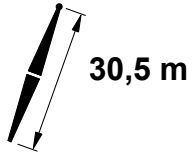
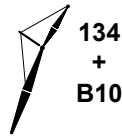

		5°						15°						
 m	 °	 m	0°	1°	2°	3°	 °	 m	0°	1°	2°	3°	 m	
			kg	kg	kg	kg			kg	kg	kg	kg		kg
10,7	80,4	47,3	20 700										10,7	
12,0	78,6	47,0	20 200										12,0	
12,2	78,4	46,9	20 200	16 800	14 500								12,2	
13,7	76,4	46,5	19 600	16 400	14 200	12 500	79,8	46,2	18 100	15 400			13,7	
14,0	76,1	46,5	19 500	16 400	14 100	12 400	79,4	46,1	18 100	15 300			14,0	
15,2	74,5	46,1	19 200	16 100	13 900	12 300	77,8	45,7	17 800	15 100	13 200	11 700	15,2	
16,0	73,4	45,8	18 900	15 900	13 800	12 200	76,8	45,5	17 600	15 000	13 100	11 700	16,0	
16,8	72,4	45,5	18 700	15 700	13 700	12 100	75,7	45,2	17 400	14 900	13 000	11 600	16,8	
18,0	70,8	45,1	18 300	15 500	13 500	11 900	74,1	44,7	17 000	14 700	12 900	11 500	18,0	
18,3	70,4	45,0	18 200	15 400	13 400	11 900	73,6	44,6	17 000	14 700	12 900	11 500	18,3	
20,0	68,1	44,3	17 800	15 100	13 200	11 700	71,3	43,9	16 600	14 400	12 700	11 300	20,0	
22,0	65,3	43,3	17 200	14 700	12 900	11 500	68,5	43,0	16 000	14 200	12 500	11 200	22,0	
24,0	62,4	42,3	16 700	14 400	12 600	11 300	65,7	41,9	15 100	14 000	12 300	11 000	24,0	
26,0	59,5	41,1	16 200	14 100	12 400	11 100	62,7	40,7	14 200	13 700	12 100	10 900	26,0	
28,0	56,5	39,7	15 700	13 800	12 200	10 900	59,6	39,3	13 400	13 300	12 000	10 800	28,0	
30,0	53,4	38,2	15 300	13 500	11 900	10 700	56,5	37,8	12 700	12 600	11 900	10 700	30,0	
32,0	50,1	36,5	14 500	13 300	11 800	10 600	53,1	36,1	12 000	12 000	11 800	10 600	32,0	
36,0	42,9	32,5	12 900	12 700	11 400	10 300	45,9	31,9	11 000	10 900	10 800	10 400	36,0	
38,1	38,5	29,7	12 200	12 100	11 300	10 200	41,4	29,1	10 500	10 500	10 400	10 200	38,1	
40,0	34,5	27,1	11 600	11 500	11 200	10 100	37,3	26,5	10 100	10 100	10 000	10 000	40,0	
41,2	31,4	24,9	11 300	11 200	11 000	10 100	34,5	24,5	9 900	9 900	9 800	9 800	41,2	
44,0	23,5	19,3	10 600	10 500	10 500	10 100							44,0	
44,2	22,9	18,8	10 500	10 500	10 400	10 100							44,2	

MLC250 S-2

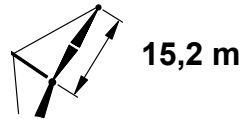
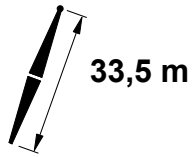

		5°					15°						
			0°	1°	2°	3°			0°	1°	2°	3°	
m	°	m	kg	kg	kg	kg	°	m	kg	kg	kg	kg	m
10,7	81,0	50,4	20 800										10,7
12,0	79,4	50,1	20 300										12,0
12,2	79,1	50,0	20 300	16 900									12,2
13,7	77,3	49,7	19 800	16 500	14 200	12 500	80,4	49,3	18 200				13,7
14,0	77,0	49,6	19 700	16 400	14 200	12 500	80,1	49,2	18 200				14,0
15,2	75,5	49,3	19 300	16 200	14 000	12 300	78,6	48,9	17 900	15 200	13 200		15,2
16,0	74,5	49,0	19 100	16 000	13 900	12 200	77,6	48,7	17 700	15 100	13 200		16,0
16,8	73,5	48,8	18 900	15 900	13 800	12 200	76,6	48,4	17 500	15 000	13 100	11 600	16,8
18,0	72,0	48,4	18 500	15 600	13 600	12 000	75,1	48,0	17 200	14 800	13 000	11 500	18,0
18,3	71,6	48,2	18 500	15 600	13 500	12 000	74,7	47,9	17 200	14 800	12 900	11 500	18,3
20,0	69,5	47,6	18 000	15 200	13 300	11 800	72,6	47,2	16 800	14 600	12 800	11 400	20,0
22,0	66,9	46,7	17 500	14 900	13 000	11 600	70,0	46,3	16 300	14 300	12 600	11 200	22,0
24,0	64,3	45,7	17 000	14 600	12 800	11 400	67,4	45,3	15 700	14 100	12 400	11 100	24,0
26,0	61,6	44,6	16 500	14 300	12 500	11 200	64,6	44,2	14 800	13 900	12 200	11 000	26,0
28,0	58,9	43,4	16 000	14 000	12 300	11 000	61,9	43,0	13 900	13 700	12 100	10 800	28,0
30,0	56,0	42,1	15 600	13 700	12 100	10 800	59,0	41,6	13 200	13 200	12 000	10 800	30,0
32,0	53,1	40,5	15 200	13 500	11 900	10 700	56,0	40,1	12 600	12 500	11 900	10 600	32,0
36,0	46,8	37,0	13 700	13 000	11 600	10 400	49,6	36,4	11 500	11 400	11 300	10 500	36,0
39,6	40,3	32,8	12 400	12 300	11 300	10 200	43,0	32,2	10 600	10 600	10 500	10 400	39,6
40,0	39,7	32,4	12 300	12 200	11 300	10 200	42,3	31,8	10 600	10 500	10 400	10 400	40,0
44,0	31,2	26,4	11 200	11 100	11 100	10 100	33,6	25,6	9 800	9 900	9 800	9 700	44,0
44,2	30,6	26,0	11 200	11 100	11 000	10 100	33,1	25,3	9 800	9 800	9 800	9 700	44,2
47,2	22,1	19,4	10 500	10 400	10 200	10 000							47,2

MLC250 S-2



83 730 kg
+
19 960 kg

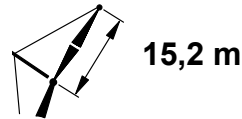
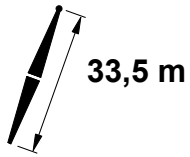

		25°					
		83 730 kg + 19 960 kg					
m	°	m	0° kg	1° kg	2° kg	3° kg	m
10,7							10,7
12,0							12,0
12,2							12,2
13,7							13,7
14,0							14,0
15,2							15,2
16,0							16,0
16,8	79,8	47,6	14 500	14 200			16,8
18,0	78,3	47,1	13 900	13 800			18,0
18,3	77,9	47,0	13 800	13 600	12 400	11 100	18,3
20,0	75,7	46,4	13 100	13 000	12 300	11 000	20,0
22,0	73,0	45,5	12 400	12 300	12 000	10 900	22,0
24,0	70,3	44,4	11 800	11 700	11 500	10 800	24,0
26,0	67,6	43,3	11 300	11 200	11 000	10 800	26,0
28,0	64,7	42,0	10 800	10 700	10 500	10 400	28,0
30,0	61,8	40,6	10 300	10 200	10 100	10 000	30,0
32,0	58,7	39,0	9 900	9 900	9 700	9 600	32,0
36,0	52,1	35,3	9 300	9 200	9 100	9 100	36,0
39,6	45,3	31,0	8 800	8 800	8 700	8 700	39,6
40,0							40,0
44,0							44,0
44,2							44,2
47,2							47,2

MLC250 S-2

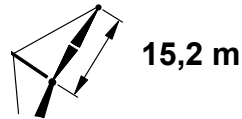
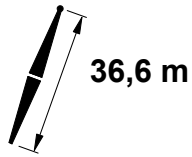

			5°				15°						
			0°	1°	2°	3°			0°	1°	2°	3°	
m	°	m	kg	kg	kg	kg	°	m	kg	kg	kg	kg	m
12,2	79,8	53,2	20 400	16 900									12,2
13,7	78,1	52,8	19 900	16 600			81,0	52,4	18 300				13,7
14,0	77,7	52,8	19 800	16 500	14 300		80,7	52,4	18 200				14,0
15,2	76,4	52,4	19 500	16 300	14 200	12 400	79,3	52,0	18 000	15 300			15,2
16,0	75,4	52,2	19 200	16 100	14 100	12 300	78,4	51,8	17 800	15 100			16,0
16,8	74,5	52,0	19 000	16 000	13 800	12 200	77,4	51,6	17 600	15 000	13 100	11 600	16,8
18,0	73,1	51,6	18 700	15 700	13 600	12 100	76,0	51,2	17 400	14 900	13 000	11 600	18,0
18,3	72,8	51,5	18 600	15 700	13 600	12 000	75,7	51,1	17 300	14 800	13 000	11 500	18,3
19,8	71,0	50,9	18 300	15 400	13 400	11 900	73,9	50,5	17 000	14 600	12 800	11 400	19,8
20,0	70,8	50,9	18 200	15 400	13 400	11 800	73,7	50,5	16 900	14 600	12 800	11 400	20,0
22,0	68,4	50,1	17 700	15 000	13 100	11 600	71,3	49,7	16 500	14 400	12 600	11 300	22,0
24,0	66,0	49,2	17 300	14 700	12 900	11 400	68,8	48,7	16 100	14 200	12 500	11 100	24,0
26,0	63,5	48,1	16 800	14 400	12 600	11 300	66,3	47,7	15 300	14 000	12 300	11 000	26,0
28,0	60,9	47,0	16 300	14 100	12 400	11 100	63,7	46,6	14 500	13 800	12 200	10 900	28,0
30,0	58,3	45,8	15 900	13 900	12 200	10 900	61,1	45,3	13 700	13 600	12 000	10 800	30,0
32,0	55,6	44,4	15 500	13 600	12 000	10 800	58,4	43,9	13 100	13 000	11 900	10 700	32,0
36,0	49,9	41,1	14 400	13 200	11 700	10 500	52,6	40,6	11 900	11 900	11 700	10 500	36,0
40,0	43,7	37,2	13 000	12 800	11 400	10 300	46,3	36,6	11 000	11 000	10 900	10 400	40,0
42,7	38,9	33,8	12 300	12 000	11 300	10 200	41,4	33,2	10 500	10 500	10 400	10 200	42,7
44,0	36,6	32,1	11 900	11 600	11 200	10 100	39,0	31,5	10 300	10 200	10 200	10 100	44,0
47,2	29,5	26,6	10 600	10 300	10 000	9 600	32,0	26,0	9 800	9 700	9 700	9 700	47,2
48,0	27,9	25,3	10 300	10 000	9 800	9 500							48,0
50,3	21,3	19,9	9 400	9 200	9 000	8 800							50,3

MLC250 S-2

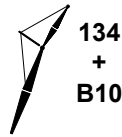

83 730 kg
+
19 960 kg

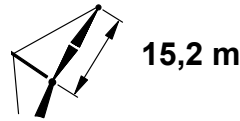
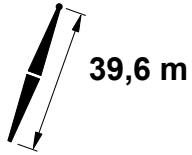

		5°					15°						
			0°	1°	2°	3°			0°	1°	2°	3°	
m	°	m	kg	kg	kg	kg	°	m	kg	kg	kg	kg	m
12,2	80,4	56,3	20 400	16 600	14 300								12,2
13,7	78,8	56,0	20 000	16 600	14 300								13,7
14,0	78,4	55,9	19 900	16 600	14 300								14,0
15,2	77,1	55,6	19 600	16 300	14 100	12 400	79,9	55,2	18 100	15 300			15,2
16,0	76,3	55,4	19 400	16 200	14 000	12 300	79,1	55,0	17 900	15 200			16,0
16,8	75,4	55,1	19 200	16 000	13 900	12 200	78,2	54,7	17 800	15 100	13 100		16,8
18,0	74,1	54,8	18 800	15 800	13 700	12 100	76,9	54,4	17 500	14 900	13 000		18,0
18,3	73,8	54,7	18 800	15 800	13 700	12 100	76,5	54,3	17 400	14 900	13 000	11 500	18,3
19,8	72,1	54,2	18 400	15 500	13 500	11 900	74,9	53,8	17 100	14 700	12 900	11 400	19,8
20,0	71,9	54,1	18 400	15 500	13 400	11 900	74,6	53,7	17 100	14 700	12 900	11 400	20,0
22,0	69,7	53,4	17 900	15 200	13 200	11 700	72,4	53,0	16 700	14 500	12 700	11 300	22,0
24,0	67,4	52,5	17 500	14 800	13 000	11 500	70,1	52,1	16 300	14 300	12 500	11 200	24,0
26,0	65,1	51,6	17 000	14 600	12 700	11 300	67,8	51,1	15 800	14 100	12 400	11 100	26,0
28,0	62,7	50,5	16 600	14 300	12 500	11 200	65,4	50,1	15 000	13 900	12 200	11 000	28,0
30,0	60,3	49,4	16 200	14 000	12 300	11 000	62,9	48,9	14 200	13 700	12 100	10 900	30,0
32,0	57,8	48,1	15 800	13 800	12 100	10 900	60,4	47,6	13 600	13 500	12 000	10 800	32,0
36,0	52,6	45,1	15 100	13 400	11 800	10 600	55,2	44,6	12 400	12 400	11 800	10 600	36,0
40,0	47,0	41,6	13 700	12 900	11 500	10 300	49,5	41,0	11 400	11 400	11 300	10 500	40,0
44,0	40,8	37,2	11 800	11 400	11 000	10 200	43,2	36,6	10 700	10 600	10 500	10 400	44,0
44,2	40,5	36,9	11 700	11 300	10 900	10 100	42,8	36,3	10 600	10 600	10 500	10 400	44,2
48,0	33,6	31,6	10 100	9 800	9 500	9 200	35,9	30,9	10 000	9 900	9 600	9 300	48,0
48,8	31,9	30,1	9 800	9 500	9 200	9 000	34,3	29,6	9 900	9 700	9 400	9 100	48,8
51,8	25,1	24,3	8 700	8 500	8 300	8 100							51,8

MLC250 S-2

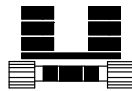

83 730 kg
+
19 960 kg

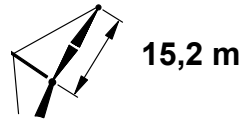
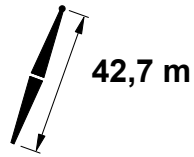

		5°						15°						
			0°	1°	2°	3°			0°	1°	2°	3°		
m	°	m	kg	kg	kg	kg	°	m	kg	kg	kg	kg	m	
12,2	80,9	59,4	20 500	16 700									12,2	
13,7	79,4	59,1	20 100	16 600									13,7	
14,0	79,1	59,0	20 000	16 600									14,0	
15,2	77,8	58,7	19 700	16 400	14 100	12 400	80,4	58,3	18 100				15,2	
16,0	77,0	58,5	19 500	16 200	14 000	12 300	79,6	58,1	18 000				16,0	
16,8	76,2	58,3	19 300	16 100	13 900	12 200	78,8	57,9	17 800	15 100	13 100		16,8	
18,0	75,0	58,0	19 000	15 900	13 700	12 100	77,6	57,6	17 600	15 000	13 000		18,0	
18,3	74,6	57,9	18 900	15 800	13 700	12 100	77,3	57,5	17 500	14 900	13 000	11 500	18,3	
19,8	73,1	57,4	18 500	15 600	13 500	11 900	75,7	57,0	17 200	14 800	12 900	11 400	19,8	
20,0	72,9	57,3	18 500	15 600	13 500	11 900	75,5	56,9	17 200	14 700	12 900	11 400	20,0	
21,3	71,5	56,9	18 200	15 400	13 300	11 800	74,1	56,5	17 000	14 600	12 800	11 400	21,3	
22,0	70,8	56,6	18 100	15 300	13 300	11 700	73,4	56,2	16 800	14 500	12 700	11 300	22,0	
24,0	68,7	55,8	17 700	15 000	13 000	11 600	71,2	55,4	16 500	14 300	12 600	11 200	24,0	
26,0	66,5	54,9	17 300	14 700	12 800	11 400	69,0	54,5	16 100	14 200	12 400	11 100	26,0	
28,0	64,3	54,0	16 800	14 400	12 600	11 200	66,8	53,5	15 500	14 000	12 300	11 000	28,0	
30,0	62,0	52,9	16 400	14 200	12 400	11 100	64,5	52,4	14 700	13 800	12 200	10 900	30,0	
32,0	59,7	51,7	16 000	13 900	12 200	10 900	62,2	51,2	14 000	13 600	12 100	10 800	32,0	
36,0	54,9	49,0	15 400	13 500	11 900	10 700	57,4	48,5	12 800	12 800	11 800	10 700	36,0	
40,0	49,8	45,7	13 600	13 000	11 600	10 400	52,2	45,2	11 900	11 800	11 600	10 600	40,0	
44,0	44,3	41,8	11 600	11 200	10 700	10 200	46,6	41,2	11 000	11 000	10 900	10 500	44,0	
47,2	39,3	37,9	10 300	9 900	9 500	9 200	41,5	37,3	10 300	10 000	9 700	9 400	47,2	
48,0	38,1	37,0	9 900	9 600	9 300	8 900	40,3	36,3	10 100	9 800	9 400	9 100	48,0	
51,8	31,1	31,1	8 600	8 300	8 100	7 800	33,2	30,4	8 700	8 500	8 200	7 900	51,8	
52,0	30,8	30,8	8 500	8 300	8 000	7 800							52,0	
54,9	24,3	25,0	7 600	7 400	7 200	7 000							54,9	

MLC250 S-2

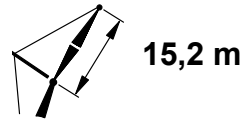
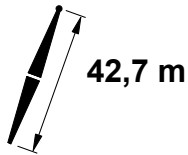

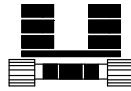
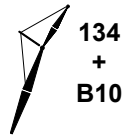

		25°					
		83 730 kg + 19 960 kg					
m	°	m	0° kg	1° kg	2° kg	3° kg	m
12,2							12,2
13,7							13,7
14,0							14,0
15,2							15,2
16,0							16,0
16,8							16,8
18,0							18,0
18,3	79,9	56,6	14 500	14 100			18,3
19,8	78,3	56,1	13 900	13 800	12 300		19,8
20,0	78,1	56,0	13 900	13 700	12 300		20,0
21,3	76,7	55,6	13 400	13 300	12 300	10 900	21,3
22,0	76,0	55,3	13 200	13 100	12 200	10 900	22,0
24,0	73,8	54,5	12 600	12 500	12 200	10 900	24,0
26,0	71,6	53,6	12 100	12 000	11 700	10 800	26,0
28,0	69,3	52,6	11 600	11 500	11 300	10 800	28,0
30,0	67,0	51,5	11 200	11 100	10 900	10 700	30,0
32,0	64,6	50,2	10 700	10 700	10 500	10 400	32,0
36,0	59,7	47,4	10 100	10 000	9 900	9 700	36,0
40,0	54,4	44,1	9 500	9 400	9 300	9 200	40,0
44,0	48,6	40,0	9 000	9 000	8 900	8 800	44,0
47,2	43,3	35,9	8 700	8 700	8 600	8 600	47,2
48,0							48,0
51,8							51,8
52,0							52,0
54,9							54,9

MLC250 S-2

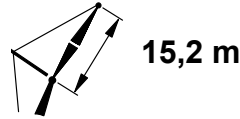
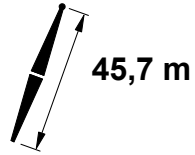

83 730 kg
+
19 960 kg

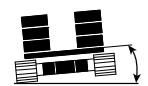
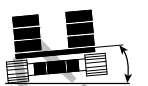

		5°						15°						
														
														
		0°	1°	2°	3°			0°	1°	2°	3°			
		kg	kg	kg	kg			kg	kg	kg	kg			
		m	°	m				°	m				m	
13,7	79,9	62,2	20 100	16 700									13,7	
14,0	79,6	62,1	20 000	16 600									14,0	
15,2	78,4	61,9	19 700	16 400	14 100		80,9	61,5	18 100				15,2	
16,0	77,7	61,7	19 500	16 300	14 000		80,2	61,3	18 000				16,0	
16,8	76,9	61,5	19 300	16 100	13 900	12 200	79,4	61,1	17 900	15 100			16,8	
18,0	75,7	61,2	19 100	15 900	13 800	12 100	78,2	60,7	17 700	15 000			18,0	
18,3	75,4	61,1	19 000	15 900	13 700	12 100	77,9	60,6	17 600	14 900	13 000	11 600	18,3	
19,8	74,0	60,6	18 700	15 700	13 500	12 000	76,4	60,2	17 300	14 800	12 900	11 500	19,8	
20,0	73,8	60,6	18 600	15 600	13 500	11 900	76,2	60,1	17 300	14 800	12 900	11 400	20,0	
21,3	72,5	60,1	18 300	15 400	13 400	11 800	74,9	59,7	17 100	14 600	12 800	11 400	21,3	
22,0	71,8	59,9	18 200	15 300	13 300	11 800	74,2	59,5	16 900	14 600	12 700	11 300	22,0	
24,0	69,8	59,1	17 800	15 000	13 100	11 600	72,2	58,7	16 600	14 400	12 600	11 200	24,0	
26,0	67,7	58,3	17 400	14 800	12 900	11 400	70,2	57,9	16 300	14 200	12 500	11 100	26,0	
28,0	65,7	57,4	17 100	14 500	12 700	11 300	68,1	56,9	15 900	14 000	12 300	11 000	28,0	
30,0	63,6	56,4	16 700	14 300	12 500	11 100	66,0	55,9	15 200	13 900	12 200	10 900	30,0	
32,0	61,4	55,3	16 300	14 100	12 300	11 000	63,8	54,8	14 500	13 700	12 100	10 900	32,0	
36,0	57,0	52,7	15 500	13 600	12 000	10 700	59,3	52,2	13 300	13 200	11 900	10 700	36,0	
40,0	52,3	49,7	13 300	12 700	11 700	10 500	54,6	49,2	12 300	12 200	11 700	10 600	40,0	
44,0	47,2	46,2	11 300	10 900	10 400	10 000	49,5	45,6	11 400	11 100	10 700	10 200	44,0	
48,0	41,7	41,9	9 700	9 300	8 900	8 600	43,9	41,3	9 900	9 500	9 100	8 800	48,0	
48,8	40,5	40,9	9 400	9 000	8 700	8 400	42,6	40,2	9 600	9 200	8 900	8 500	48,8	
52,0	35,5	36,6	8 300	8 000	7 700	7 400	37,5	35,9	8 400	8 100	7 800	7 500	52,0	
54,9	30,2	31,7	7 400	7 200	6 900	6 700	32,2	31,1	7 500	7 300	7 000	6 800	54,9	
56,0	28,0	29,8	7 100	6 800	6 600	6 400							56,0	
57,9	23,7	25,6	6 500	6 300	6 100	6 000							57,9	

MLC250 S-2

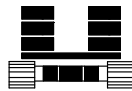

83 730 kg
+
19 960 kg

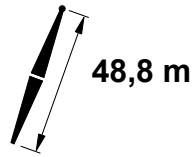

48,8 m

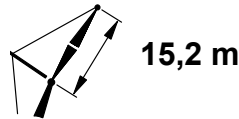

15,2 m

		5°						15°						
			0°	1°	2°	3°			0°	1°	2°	3°		
	m	°	kg	kg	kg	kg	°	m	kg	kg	kg	kg	m	
13,7	80,4	65,3	20 100										13,7	
14,0	80,1	65,2	20 000										14,0	
15,2	79,0	65,0	19 800	16 400	14 100								15,2	
16,0	78,3	64,8	19 600	16 300	14 000								16,0	
16,8	77,5	64,6	19 400	16 100	13 900	12 200	80,0	64,2	17 900	15 100			16,8	
18,0	76,4	64,3	19 100	16 000	13 800	12 100	78,8	63,9	17 700	15 000			18,0	
18,3	76,1	64,2	19 100	15 900	13 700	12 100	78,5	63,8	17 700	14 900	13 000		18,3	
19,8	74,7	63,8	18 700	15 700	13 600	12 000	77,1	63,4	17 400	14 800	12 900	11 400	19,8	
20,0	74,6	63,7	18 700	15 700	13 500	11 900	76,9	63,3	17 400	14 800	12 900	11 400	20,0	
21,3	73,3	63,3	18 400	15 500	13 400	11 800	75,7	62,9	17 200	14 600	12 800	11 400	21,3	
22,0	72,7	63,1	18 300	15 400	13 300	11 800	75,0	62,7	17 000	14 600	12 700	11 300	22,0	
22,9	71,8	62,8	18 100	15 300	13 200	11 700	74,2	62,4	16 900	14 500	12 700	11 300	22,9	
24,0	70,8	62,4	17 900	15 100	13 100	11 600	73,1	62,0	16 700	14 400	12 600	11 200	24,0	
26,0	68,9	61,6	17 600	14 900	12 900	11 500	71,2	61,2	16 400	14 200	12 500	11 100	26,0	
28,0	66,9	60,7	17 200	14 600	12 700	11 300	69,2	60,3	16 100	14 100	12 400	11 000	28,0	
30,0	64,9	59,8	16 800	14 400	12 600	11 200	67,2	59,3	15 600	13 900	12 300	10 900	30,0	
32,0	62,9	58,7	16 500	14 200	12 400	11 000	65,2	58,3	14 900	13 800	12 100	10 900	32,0	
36,0	58,7	56,4	15 500	13 700	12 100	10 800	61,0	55,9	13 700	13 500	12 000	10 700	36,0	
40,0	54,4	53,6	13 100	12 500	11 700	10 500	56,6	53,1	12 700	12 600	11 800	10 600	40,0	
44,0	49,8	50,3	11 100	10 600	10 200	9 700	51,9	49,8	11 400	10 900	10 400	10 000	44,0	
48,0	44,8	46,5	9 500	9 100	8 700	8 300	46,9	45,9	9 700	9 300	8 900	8 500	48,0	
51,8	39,5	42,0	8 100	7 800	7 500	7 200	41,5	41,4	8 300	8 000	7 700	7 400	51,8	
52,0	39,3	41,8	8 100	7 800	7 500	7 100	41,3	41,1	8 300	7 900	7 600	7 300	52,0	
56,0	33,0	36,0	6 900	6 600	6 400	6 100	34,9	35,3	7 000	6 800	6 500	6 300	56,0	
57,9	29,3	32,4	6 400	6 200	5 900	5 700	31,3	31,9	6 500	6 300	6 000	5 800	57,9	
60,0	25,3	28,4	5 900	5 700	5 500	5 300							60,0	
61,0	23,1	26,2	5 600	5 400	5 300	5 100							61,0	

MLC250 S-2

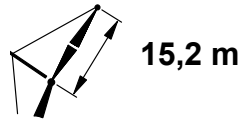
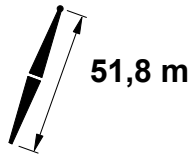

			5°				15°						
			0°	1°	2°	3°			0°	1°	2°	3°	
m	°	m	kg	kg	kg	kg	°	m	kg	kg	kg	kg	m
13,7	80,8	68,4	20 100										13,7
14,0	80,6	68,3	20 100										14,0
15,2	79,5	68,1	19 800	16 400									15,2
16,0	78,8	67,9	19 600	16 300									16,0
16,8	78,1	67,7	19 400	16 100	13 900		80,4	67,3	17 900				16,8
18,0	77,1	67,5	19 200	16 000	13 700		79,3	67,0	17 700				18,0
18,3	76,8	67,4	19 100	15 900	13 700	12 100	79,1	66,9	17 700	14 900			18,3
19,8	75,5	67,0	18 800	15 700	13 600	11 900	77,7	66,5	17 500	14 800	12 900	11 400	19,8
20,0	75,3	66,9	18 800	15 700	13 500	11 900	77,6	66,5	17 500	14 800	12 900	11 400	20,0
21,3	74,1	66,5	18 500	15 500	13 400	11 800	76,4	66,1	17 200	14 700	12 800	11 300	21,3
22,0	73,5	66,3	18 400	15 400	13 300	11 800	75,8	65,9	17 100	14 600	12 700	11 300	22,0
22,9	72,7	66,0	18 200	15 300	13 200	11 700	74,9	65,6	17 000	14 500	12 700	11 300	22,9
24,0	71,7	65,6	18 000	15 100	13 100	11 600	73,9	65,2	16 800	14 400	12 600	11 200	24,0
26,0	69,9	64,9	17 700	14 900	13 000	11 500	72,1	64,4	16 500	14 300	12 500	11 100	26,0
28,0	68,0	64,1	17 300	14 700	12 800	11 300	70,2	63,6	16 200	14 100	12 400	11 000	28,0
30,0	66,2	63,2	17 000	14 400	12 600	11 200	68,3	62,7	15 900	14 000	12 300	11 000	30,0
32,0	64,2	62,2	16 700	14 200	12 400	11 100	66,4	61,7	15 300	13 900	12 200	10 900	32,0
36,0	60,3	60,0	15 400	13 800	12 100	10 800	62,5	59,5	14 100	13 600	12 000	10 700	36,0
40,0	56,3	57,4	12 900	12 300	11 600	10 600	58,4	56,9	13 000	12 600	11 800	10 600	40,0
44,0	52,0	54,3	10 900	10 400	9 900	9 400	54,0	53,8	11 200	10 700	10 200	9 700	44,0
48,0	47,4	50,8	9 300	8 800	8 400	8 000	49,4	50,2	9 500	9 100	8 700	8 300	48,0
52,0	42,4	46,6	7 900	7 500	7 200	6 900	44,4	46,0	8 100	7 700	7 400	7 100	52,0
53,3	40,6	44,9	7 500	7 100	6 800	6 500	42,5	44,2	7 700	7 300	7 000	6 700	53,3
56,0	36,9	41,5	6 700	6 400	6 100	5 900	38,8	40,8	6 800	6 600	6 300	6 000	56,0
59,4	31,4	36,1	5 800	5 600	5 300	5 100	33,3	35,4	5 900	5 700	5 400	5 200	59,4
60,0	30,5	35,2	5 700	5 400	5 200	5 000							60,0
64,0	22,5	26,8	4 700	4 600	4 400	4 200							64,0

MLC250 S-2

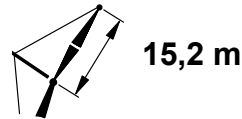
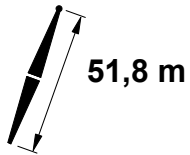
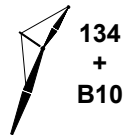

				25°					
				0°	1°	2°	3°		
				kg	kg	kg	kg		
				kg	kg	kg	kg		
				kg	kg	kg	kg		
				kg	kg	kg	kg		
				kg	kg	kg	kg		
				kg	kg	kg	kg		
				kg	kg	kg	kg		
				kg	kg	kg	kg		
				kg	kg	kg	kg		
				kg	kg	kg	kg		
				kg	kg	kg	kg		
				kg	kg	kg	kg		
				kg	kg	kg	kg		
				kg	kg	kg	kg		
				kg	kg	kg	kg		
				kg	kg	kg	kg		
				kg	kg	kg	kg		
				kg	kg	kg	kg		
				kg	kg	kg	kg		
				kg	kg	kg	kg		
				kg	kg	kg	kg		
				kg	kg	kg	kg		
				kg	kg	kg	kg		
				kg	kg	kg	kg		
				kg	kg	kg	kg		
				kg	kg	kg	kg		
				kg	kg	kg	kg		
				kg	kg	kg	kg		
				kg	kg	kg	kg		
				kg	kg	kg	kg		
				kg	kg	kg	kg		
				kg	kg	kg	kg		
				kg	kg	kg	kg		
				kg	kg	kg	kg		
				kg	kg	kg	kg		
				kg	kg	kg	kg		
				kg	kg	kg	kg		
				kg	kg	kg	kg		
				kg	kg	kg	kg		
				kg	kg	kg	kg		
				kg	kg	kg	kg		
				kg	kg	kg	kg		
				kg	kg	kg	kg		
				kg	kg	kg	kg		
				kg	kg	kg	kg		
				kg	kg	kg	kg		
				kg	kg	kg	kg		
				kg	kg	kg	kg		
				kg	kg	kg	kg		
				kg	kg	kg	kg		
				kg	kg	kg	kg		
				kg	kg	kg	kg		
				kg	kg	kg	kg		
				kg	kg	kg	kg		
				kg	kg	kg	kg		
				kg	kg	kg	kg		
				kg	kg	kg	kg		
				kg	kg	kg	kg		
				kg	kg	kg	kg		
				kg	kg	kg	kg		
				kg	kg	kg	kg		
				kg	kg	kg	kg		
				kg	kg	kg	kg		
				kg	kg	kg	kg		
				kg	kg	kg	kg		
				kg	kg	kg	kg		
				kg	kg	kg	kg		
				kg	kg	kg	kg		
				kg	kg	kg	kg		
				kg	kg	kg	kg		
				kg	kg	kg	kg		
				kg	kg	kg	kg		
				kg	kg	kg	kg		
				kg	kg	kg	kg		
				kg	kg	kg	kg		
				kg	kg	kg	kg		
				kg	kg	kg	kg		
				kg	kg	kg	kg		
				kg	kg	kg	kg		
				kg	kg	kg	kg		
				kg	kg	kg	kg		
				kg	kg	kg	kg		
				kg	kg	kg	kg		
				kg	kg	kg	kg		
				kg	kg	kg	kg		
				kg	kg	kg	kg		
				kg	kg	kg	kg		
				kg	kg	kg	kg		

MLC250 S-2



83 730 kg
+
19 960 kg

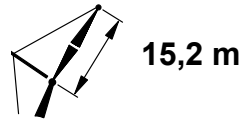
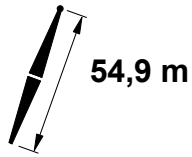

		5°						15°						
			0°	1°	2°	3°			0°	1°	2°	3°		
m	°	m	kg	kg	kg	kg	°	m	kg	kg	kg	kg	m	
15,2	79,9	71,2	19 800	16 300									15,2	
16,0	79,3	71,1	19 600	16 200									16,0	
16,8	78,6	70,9	19 400	16 100	13 900		80,9	70,5	17 900				16,8	
18,0	77,6	70,6	19 200	15 900	13 700		79,8	70,2	17 700				18,0	
18,3	77,4	70,5	19 100	15 900	13 700	12 000	79,6	70,1	17 700	14 900			18,3	
19,8	76,1	70,1	18 800	15 700	13 500	11 900	78,3	69,7	17 500	14 800	12 800		19,8	
20,0	75,9	70,1	18 800	15 700	13 500	11 900	78,1	69,7	17 500	14 800	12 800		20,0	
21,3	74,8	69,7	18 600	15 500	13 400	11 800	77,0	69,3	17 300	14 700	12 800	11 300	21,3	
22,0	74,2	69,5	18 400	15 400	13 300	11 800	76,4	69,1	17 200	14 600	12 700	11 300	22,0	
22,9	73,5	69,2	18 300	15 300	13 200	11 700	75,6	68,8	17 100	14 500	12 700	11 200	22,9	
24,0	72,5	68,9	18 100	15 200	13 100	11 600	74,7	68,4	16 900	14 400	12 600	11 200	24,0	
26,0	70,8	68,2	17 700	14 900	13 000	11 500	72,9	67,7	16 600	14 300	12 500	11 100	26,0	
28,0	69,0	67,4	17 400	14 700	12 800	11 300	71,2	66,9	16 300	14 100	12 400	11 000	28,0	
30,0	67,3	66,5	17 100	14 500	12 600	11 200	69,4	66,1	16 100	14 000	12 300	11 000	30,0	
32,0	65,5	65,6	16 800	14 300	12 500	11 100	67,5	65,1	15 700	13 900	12 200	10 900	32,0	
36,0	61,8	63,5	15 200	13 900	12 200	10 800	63,8	63,0	14 500	13 600	12 000	10 700	36,0	
40,0	57,9	61,1	12 700	12 000	11 400	10 500	60,0	60,6	13 100	12 400	11 700	10 600	40,0	
44,0	53,9	58,2	10 700	10 200	9 600	9 100	55,9	57,7	11 100	10 500	10 000	9 400	44,0	
48,0	49,7	54,9	9 100	8 600	8 200	7 800	51,6	54,4	9 400	8 900	8 500	8 000	48,0	
52,0	45,2	51,1	7 700	7 300	7 000	6 600	47,1	50,5	7 900	7 500	7 200	6 800	52,0	
56,0	40,2	46,6	6 500	6 200	5 900	5 600	42,0	45,9	6 700	6 400	6 100	5 800	56,0	
56,4	39,7	46,0	6 400	6 100	5 800	5 500	41,5	45,4	6 600	6 300	6 000	5 700	56,4	
60,0	34,7	41,1	5 500	5 200	5 000	4 700	36,4	40,3	5 600	5 400	5 100	4 900	60,0	
62,5	30,6	36,8	4 900	4 700	4 500	4 300	32,4	36,2	5 000	4 800	4 600	4 400	62,5	
64,0	28,2	34,2	4 600	4 400	4 200	4 000							64,0	
67,1	22,0	27,3	3 900	3 800	3 600	3 500							67,1	

MLC250 S-2

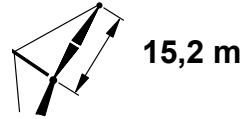
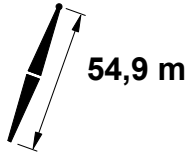
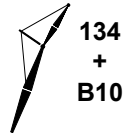

				25°					
				0°	1°	2°	3°		
				kg	kg	kg	kg		
				kg	kg	kg	kg		
				kg	kg	kg	kg		
				kg	kg	kg	kg		
				kg	kg	kg	kg		
				kg	kg	kg	kg		
				kg	kg	kg	kg		
				kg	kg	kg	kg		
				kg	kg	kg	kg		
				kg	kg	kg	kg		
				kg	kg	kg	kg		
				kg	kg	kg	kg		
				kg	kg	kg	kg		
				kg	kg	kg	kg		
				kg	kg	kg	kg		
				kg	kg	kg	kg		
				kg	kg	kg	kg		
				kg	kg	kg	kg		
				kg	kg	kg	kg		
				kg	kg	kg	kg		
				kg	kg	kg	kg		
				kg	kg	kg	kg		
				kg	kg	kg	kg		
				kg	kg	kg	kg		
				kg	kg	kg	kg		
				kg	kg	kg	kg		
				kg	kg	kg	kg		
				kg	kg	kg	kg		
				kg	kg	kg	kg		
				kg	kg	kg	kg		
				kg	kg	kg	kg		
				kg	kg	kg	kg		
				kg	kg	kg	kg		
				kg	kg	kg	kg		
				kg	kg	kg	kg		
				kg	kg	kg	kg		
				kg	kg	kg	kg		
				kg	kg	kg	kg		
				kg	kg	kg	kg		
				kg	kg	kg	kg		
				kg	kg	kg	kg		
				kg	kg	kg	kg		
				kg	kg	kg	kg		
				kg	kg	kg	kg		
				kg	kg	kg	kg		
				kg	kg	kg	kg		
				kg	kg	kg	kg		
				kg	kg	kg	kg		
				kg	kg	kg	kg		
				kg	kg	kg	kg		
				kg	kg	kg	kg		
				kg	kg	kg	kg		
				kg	kg	kg	kg		
				kg	kg	kg	kg		
				kg	kg	kg	kg		
				kg	kg	kg	kg		
				kg	kg	kg	kg		
				kg	kg	kg	kg		
				kg	kg	kg	kg		
				kg	kg	kg	kg		
				kg	kg	kg	kg		
				kg	kg	kg	kg		
				kg	kg	kg	kg		
				kg	kg	kg	kg		
				kg	kg	kg	kg		
				kg	kg	kg	kg		
				kg	kg	kg	kg		
				kg	kg	kg	kg		
				kg	kg	kg	kg		
				kg	kg	kg	kg		
				kg	kg	kg	kg		
				kg	kg	kg	kg		
				kg	kg	kg	kg		
				kg	kg	kg	kg		
				kg	kg	kg	kg		
				kg	kg	kg	kg		
				kg	kg	kg	kg		
				kg	kg	kg	kg		
				kg	kg	kg	kg		
				kg	kg	kg	kg		
				kg	kg	kg	kg		
				kg	kg	kg	kg		
				kg	kg	kg	kg		
				kg	kg	kg	kg		
				kg	kg	kg	kg		
				kg	kg	kg	kg		
				kg	kg	kg	kg		
				kg	kg	kg	kg		

MLC250 S-2

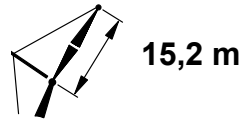
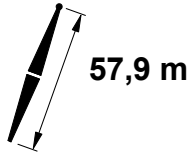
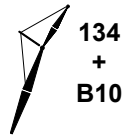

			5°				15°						
			0°	1°	2°	3°			0°	1°	2°	3°	
m	°	m	kg	kg	kg	kg	°	m	kg	kg	kg	kg	m
15,2	80,4	74,3	19 700										15,2
16,0	79,8	74,2	19 600										16,0
16,8	79,1	74,0	19 400	16 100									16,8
18,0	78,2	73,7	19 200	15 900									18,0
18,3	77,9	73,7	19 100	15 900	13 700	12 000							18,3
19,8	76,7	73,3	18 800	15 700	13 500	11 900	80,0	73,2	17 700				19,8
20,0	76,6	73,2	18 800	15 700	13 500	11 900	78,8	72,9	17 500	14 800	12 800		20,0
21,3	75,5	72,9	18 600	15 500	13 400	11 800	78,6	72,8	17 500	14 700	12 800		21,3
22,0	74,9	72,7	18 500	15 400	13 300	11 700	77,6	72,4	17 300	14 600	12 700	11 300	21,3
22,9	74,2	72,4	18 300	15 300	13 200	11 700	77,0	72,3	17 200	14 600	12 700	11 200	22,0
22,9	74,2	72,4	18 300	15 300	13 200	11 700	77,0	72,3	17 200	14 600	12 700	11 200	22,9
24,0	73,3	72,1	18 100	15 200	13 100	11 600	76,2	72,0	17 100	14 500	12 600	11 200	24,0
24,4	73,0	71,9	18 100	15 200	13 100	11 600	75,3	71,6	16 900	14 400	12 600	11 200	24,0
24,4	73,0	71,9	18 100	15 200	13 100	11 600	75,0	71,5	16 900	14 400	12 600	11 100	24,4
26,0	71,6	71,4	17 800	15 000	13 000	11 400	73,7	70,9	16 700	14 300	12 500	11 100	26,0
28,0	70,0	70,7	17 500	14 700	12 800	11 300	73,7	70,9	16 700	14 300	12 500	11 100	28,0
30,0	68,3	69,8	17 200	14 500	12 600	11 200	72,0	70,2	16 400	14 200	12 400	11 000	30,0
30,0	68,3	69,8	17 200	14 500	12 600	11 200	70,3	69,4	16 100	14 000	12 300	10 900	30,0
32,0	66,6	69,0	16 900	14 300	12 500	11 100	70,3	69,4	16 100	14 000	12 300	10 900	32,0
36,0	63,1	67,0	15 000	13 800	12 200	10 800	68,6	68,5	15 900	13 900	12 200	10 800	32,0
40,0	59,4	64,7	12 500	11 800	11 100	10 400	65,0	66,5	14 900	13 700	12 000	10 700	36,0
44,0	55,7	62,0	10 500	9 900	9 300	8 800	61,4	64,2	12 900	12 200	11 500	10 500	40,0
48,0	51,7	58,9	8 800	8 300	7 900	7 400	57,6	61,5	10 800	10 200	9 700	9 100	44,0
48,0	51,7	58,9	8 800	8 300	7 900	7 400	53,6	58,4	9 100	8 600	8 200	7 700	48,0
52,0	47,5	55,4	7 400	7 000	6 600	6 300	49,4	54,8	7 700	7 300	6 900	6 500	52,0
56,0	43,0	51,3	6 200	5 900	5 600	5 300	44,8	50,6	6 400	6 100	5 800	5 500	56,0
57,9	40,7	48,9	5 700	5 400	5 100	4 900	42,4	48,3	5 900	5 600	5 300	5 000	57,9
60,0	38,1	46,4	5 200	4 900	4 700	4 400	42,4	48,3	5 900	5 600	5 300	5 000	60,0
64,0	32,5	40,5	4 300	4 100	3 900	3 700	39,8	45,7	5 400	5 100	4 800	4 600	64,0
64,0	32,5	40,5	4 300	4 100	3 900	3 700	34,1	39,7	4 400	4 200	4 000	3 800	64,0
65,5	29,9	37,6	4 000	3 800	3 600	3 400	31,7	37,0	4 100	3 900	3 700	3 500	65,5
68,0	25,8	32,9	3 500	3 300	3 200	3 000							68,0
70,1	21,5	27,9	3 100	3 000	2 800	2 700							70,1

MLC250 S-2

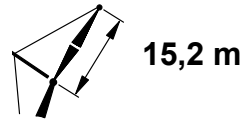
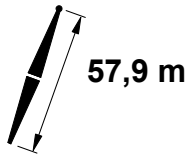
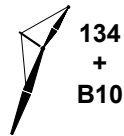

		25°					
		83 730 kg + 19 960 kg					
m	°	m	0° kg	1° kg	2° kg	3° kg	m
15,2							15,2
16,0							16,0
16,8							16,8
18,0							18,0
18,3							18,3
19,8	80,9	71,9	14 800				19,8
20,0	80,7	71,9	14 800				20,0
21,3	79,6	71,5	14 400	13 900			21,3
22,0	79,1	71,3	14 200	13 800			22,0
22,9	78,3	71,0	13 900	13 700	12 100		22,9
24,0	77,4	70,7	13 600	13 500	12 100		24,0
24,4	77,1	70,5	13 500	13 400	12 100	10 800	24,4
26,0	75,7	70,0	13 100	13 000	12 000	10 800	26,0
28,0	74,0	69,2	12 700	12 500	12 000	10 700	28,0
30,0	72,3	68,4	12 200	12 100	11 900	10 700	30,0
32,0	70,5	67,5	11 800	11 700	11 500	10 700	32,0
36,0	66,9	65,5	11 100	11 000	10 900	10 700	36,0
40,0	63,2	63,1	10 500	10 500	10 300	10 200	40,0
44,0	59,4	60,4	10 000	9 900	9 800	9 400	44,0
48,0	55,3	57,2	9 400	8 900	8 400	8 000	48,0
52,0	51,0	53,6	7 900	7 500	7 100	6 700	52,0
56,0	46,3	49,3	6 600	6 300	6 000	5 600	56,0
57,9	43,9	46,9	6 100	5 800	5 500	5 200	57,9
60,0							60,0
64,0							64,0
65,5							65,5
68,0							68,0
70,1							70,1

MLC250 S-2

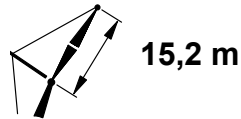
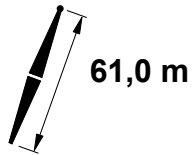

			5°				15°						
			0°	1°	2°	3°			0°	1°	2°	3°	
m	°	m	kg	kg	kg	kg	°	m	kg	kg	kg	kg	m
15,2	80,8	77,4	19 700										15,2
16,0	80,2	77,3	19 500										16,0
16,8	79,6	77,1	19 400	16 000									16,8
18,0	78,6	76,9	19 200	15 900									18,0
18,3	78,4	76,8	19 100	15 800	13 600		80,4	76,4	17 600				18,3
19,8	77,3	76,4	18 800	15 600	13 500	11 800	79,2	76,0	17 500	14 700			19,8
20,0	77,1	76,4	18 800	15 600	13 400	11 800	79,1	75,9	17 400	14 700			20,0
21,3	76,1	76,0	18 600	15 500	13 300	11 700	78,1	75,6	17 300	14 600	12 700		21,3
22,0	75,5	75,9	18 500	15 400	13 300	11 700	77,5	75,4	17 200	14 500	12 600		22,0
22,9	74,8	75,6	18 300	15 300	13 200	11 600	76,8	75,1	17 100	14 500	12 600	11 200	22,9
24,0	74,0	75,3	18 100	15 200	13 100	11 600	76,0	74,8	17 000	14 400	12 500	11 100	24,0
24,4	73,7	75,1	18 100	15 100	13 100	11 500	75,6	74,7	16 900	14 400	12 500	11 100	24,4
26,0	72,4	74,6	17 800	14 900	12 900	11 400	74,4	74,2	16 700	14 300	12 400	11 000	26,0
28,0	70,8	73,9	17 500	14 700	12 800	11 300	72,8	73,5	16 500	14 100	12 300	11 000	28,0
30,0	69,2	73,1	17 200	14 500	12 600	11 200	71,1	72,7	16 200	14 000	12 200	10 900	30,0
32,0	67,6	72,3	17 000	14 300	12 500	11 100	69,5	71,8	16 000	13 900	12 200	10 800	32,0
36,0	64,2	70,4	14 800	13 700	12 200	10 900	66,1	69,9	15 100	13 700	12 000	10 700	36,0
40,0	60,8	68,2	12 300	11 500	10 800	10 100	62,7	67,7	12 700	11 900	11 200	10 500	40,0
44,0	57,2	65,7	10 300	9 700	9 100	8 500	59,1	65,2	10 600	10 000	9 400	8 900	44,0
48,0	53,5	62,8	8 600	8 100	7 600	7 200	55,4	62,3	8 900	8 400	7 900	7 500	48,0
52,0	49,6	59,5	7 200	6 800	6 400	6 000	51,4	59,0	7 500	7 100	6 700	6 300	52,0
56,0	45,5	55,7	6 000	5 700	5 400	5 000	47,2	55,1	6 300	5 900	5 600	5 200	56,0
60,0	41,0	51,3	5 000	4 700	4 400	4 200	42,7	50,6	5 200	4 900	4 600	4 300	60,0
61,0	39,8	50,0	4 800	4 500	4 200	4 000	41,5	49,4	5 000	4 700	4 400	4 100	61,0
64,0	36,0	46,1	4 100	3 900	3 600	3 400	37,6	45,3	4 300	4 000	3 800	3 500	64,0
67,1	31,7	41,2	3 500	3 300	3 100	2 900	33,3	40,5	3 600	3 400	3 200	3 000	67,1
68,0	30,4	39,7	3 300	3 100	2 900	2 700							68,0
72,0	23,4	31,4	2 600	2 400	2 300	2 100							72,0
73,2	21,0	28,4	2 400	2 300	2 100	2 000							73,2

MLC250 S-2

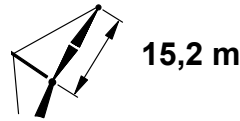
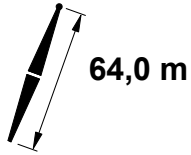
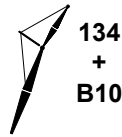

			5°				15°						
			0°	1°	2°	3°			0°	1°	2°	3°	
m	°	m	kg	kg	kg	kg	°	m	kg	kg	kg	kg	m
16,8	80,0	80,2	19 300										16,8
18,0	79,1	80,0	19 100										18,0
18,3	78,9	79,9	19 100	15 700	13 500		80,8	79,5	17 600				18,3
19,8	77,7	79,6	18 800	15 600	13 400	11 800	79,7	79,1	17 400	14 700			19,8
20,0	77,6	79,5	18 800	15 600	13 400	11 800	79,5	79,1	17 400	14 600			20,0
21,3	76,6	79,2	18 600	15 400	13 300	11 700	78,5	78,7	17 300	14 500	12 600		21,3
22,0	76,1	79,0	18 400	15 300	13 200	11 600	78,0	78,6	17 200	14 500	12 600		22,0
22,9	75,4	78,8	18 300	15 200	13 100	11 600	77,3	78,3	17 100	14 400	12 600	11 100	22,9
24,0	74,6	78,5	18 100	15 100	13 100	11 500	76,5	78,0	17 000	14 400	12 500	11 100	24,0
24,4	74,3	78,3	18 100	15 100	13 000	11 500	76,2	77,9	16 900	14 300	12 500	11 100	24,4
25,9	73,2	77,9	17 900	14 900	12 900	11 400	75,1	77,4	16 800	14 200	12 400	11 000	25,9
26,0	73,1	77,8	17 800	14 900	12 900	11 400	75,0	77,4	16 700	14 200	12 400	11 000	26,0
28,0	71,6	77,2	17 600	14 700	12 800	11 300	73,5	76,7	16 500	14 100	12 300	10 900	28,0
30,0	70,0	76,4	17 300	14 500	12 600	11 100	71,9	76,0	16 300	14 000	12 200	10 900	30,0
32,0	68,5	75,6	17 000	14 400	12 500	11 000	70,3	75,1	16 100	13 900	12 100	10 800	32,0
36,0	65,3	73,8	14 600	13 500	12 200	10 800	67,1	73,3	15 100	13 700	12 000	10 700	36,0
40,0	62,0	71,7	12 100	11 300	10 500	9 800	63,9	71,2	12 500	11 700	10 900	10 200	40,0
44,0	58,7	69,4	10 000	9 400	8 800	8 200	60,5	68,8	10 400	9 800	9 200	8 600	44,0
48,0	55,2	66,6	8 400	7 900	7 400	6 900	56,9	66,1	8 700	8 200	7 700	7 200	48,0
52,0	51,5	63,5	7 000	6 600	6 100	5 700	53,2	63,0	7 300	6 800	6 400	6 000	52,0
56,0	47,6	60,0	5 800	5 400	5 100	4 700	49,3	59,4	6 100	5 700	5 300	5 000	56,0
60,0	43,5	55,9	4 800	4 500	4 200	3 900	45,2	55,3	5 000	4 700	4 400	4 100	60,0
62,5	40,7	53,0	4 200	4 000	3 700	3 400	42,3	52,3	4 400	4 100	3 900	3 600	62,5
64,0	39,0	51,2	3 900	3 600	3 400	3 100	40,6	50,5	4 100	3 800	3 500	3 300	64,0
68,0	34,0	45,6	3 100	2 900	2 700	2 500	35,5	44,8	3 200	3 000	2 800	2 600	68,0
70,1	31,0	41,9	2 700	2 500	2 300	2 200	32,6	41,3	2 800	2 600	2 400	2 200	70,1
71,6	28,8	39,3	2 500	2 300	2 100	1 900							71,6
72,0	28,3	38,7	2 400	2 200	2 000								72,0
73,2	26,3	36,2	2 200	2 000	1 900								73,2
74,7	23,7	32,9	2 000	1 800									74,7

MLC250 S-2

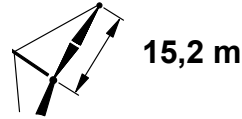
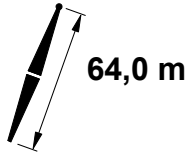
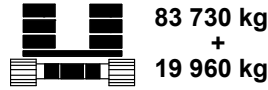
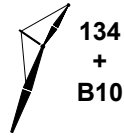

		25°					
		83 730 kg + 19 960 kg					
m	°	m	0° kg	1° kg	2° kg	3° kg	m
16,8							16,8
18,0							18,0
18,3							18,3
19,8							19,8
20,0							20,0
21,3	80,4	77,8	14 700				21,3
22,0	79,9	77,6	14 500				22,0
22,9	79,3	77,4	14 200	13 800			22,9
24,0	78,4	77,0	13 900	13 700			24,0
24,4	78,1	76,9	13 800	13 700	12 000		24,4
25,9	76,9	76,4	13 500	13 400	12 000	10 700	25,9
26,0	76,9	76,4	13 500	13 300	12 000	10 700	26,0
28,0	75,3	75,7	13 000	12 900	11 900	10 600	28,0
30,0	73,7	75,0	12 600	12 500	11 900	10 600	30,0
32,0	72,2	74,1	12 200	12 100	11 900	10 600	32,0
36,0	68,9	72,3	11 500	11 400	11 200	10 600	36,0
40,0	65,6	70,2	10 900	10 800	10 700	10 400	40,0
44,0	62,1	67,8	10 400	10 100	9 500	8 900	44,0
48,0	58,5	65,0	9 000	8 500	8 000	7 500	48,0
52,0	54,8	61,8	7 600	7 100	6 700	6 200	52,0
56,0	50,8	58,1	6 300	5 900	5 500	5 200	56,0
60,0	46,5	53,9	5 200	4 900	4 500	4 200	60,0
62,5	43,7	50,9	4 600	4 300	4 000	3 700	62,5
64,0							64,0
68,0							68,0
70,1							70,1
71,6							71,6
72,0							72,0
73,2							73,2
74,7							74,7

MLC250 S-2

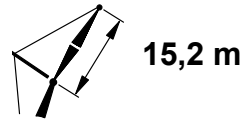
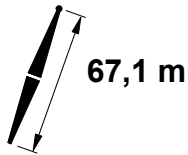

				25°					
				83 730 kg + 19 960 kg					
				0°	1°	2°	3°		
				kg	kg	kg	kg		
				kg	kg	kg	kg		
m	°	m		kg	kg	kg	kg	m	
16,8								16,8	
18,0								18,0	
18,3								18,3	
19,8								19,8	
20,0								20,0	
21,3	80,8	80,9		14 800				21,3	
22,0	80,3	80,8		14 600				22,0	
22,9	79,7	80,5		14 400	13 700			22,9	
24,0	78,9	80,2		14 100	13 700			24,0	
24,4	78,6	80,1		14 000	13 600	11 900		24,4	
25,9	77,5	79,6		13 600	13 500	11 900	10 600	25,9	
26,0	77,4	79,6		13 600	13 500	11 900	10 600	26,0	
28,0	75,9	78,9		13 200	13 100	11 900	10 600	28,0	
30,0	74,4	78,2		12 800	12 600	11 900	10 600	30,0	
32,0	72,9	77,4		12 400	12 300	11 800	10 500	32,0	
36,0	69,8	75,7		11 700	11 600	11 400	10 500	36,0	
40,0	66,6	73,7		11 100	11 000	10 800	10 400	40,0	
44,0	63,3	71,3		10 600	10 000	9 300	8 700	44,0	
48,0	59,9	68,7		8 900	8 300	7 800	7 200	48,0	
52,0	56,4	65,7		7 400	6 900	6 500	6 000	52,0	
56,0	52,7	62,3		6 100	5 700	5 300	5 000	56,0	
60,0	48,7	58,4		5 000	4 700	4 300	4 000	60,0	
64,0	44,4	53,9		4 000	3 700	3 500	3 200	64,0	
65,5	42,7	52,0		3 700	3 400	3 200	2 900	65,5	
68,0								68,0	
70,1								70,1	
71,6								71,6	
72,0								72,0	
73,2								73,2	
74,7								74,7	

MLC250 S-2

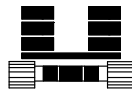

83 730 kg
+
19 960 kg

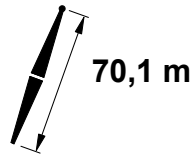

70,1 m

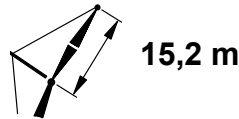

15,2 m

		5°					15°						
			0°	1°	2°	3°			0°	1°	2°	3°	
m	°	m	kg	kg	kg	kg	°	m	kg	kg	kg	kg	m
16,8	80,7	86,4	19 100										16,8
18,0	79,9	86,2	18 900										18,0
18,3	79,7	86,1	18 900	15 600									18,3
19,8	78,6	85,8	18 700	15 400	13 200		80,4	85,4	17 300				19,8
20,0	78,5	85,8	18 600	15 400	13 200		80,3	85,3	17 300				20,0
21,3	77,6	85,5	18 400	15 300	13 100	11 500	79,4	85,0	17 200	14 400			21,3
22,0	77,1	85,3	18 300	15 200	13 100	11 500	78,9	84,9	17 100	14 400			22,0
22,9	76,5	85,1	18 200	15 100	13 000	11 400	78,3	84,6	17 000	14 300	12 400		22,9
24,0	75,7	84,8	18 100	15 000	12 900	11 300	77,5	84,3	16 900	14 200	12 300		24,0
24,4	75,5	84,7	18 000	15 000	12 900	11 300	77,2	84,2	16 900	14 200	12 300	10 900	24,4
25,9	74,4	84,2	17 800	14 800	12 800	11 300	76,2	83,8	16 800	14 100	12 300	10 900	25,9
26,0	74,3	84,2	17 800	14 800	12 800	11 300	76,1	83,8	16 800	14 100	12 300	10 900	26,0
28,0	72,9	83,6	17 500	14 600	12 600	11 100	74,7	83,1	16 500	14 000	12 200	10 800	28,0
30,0	71,5	82,9	17 300	14 400	12 500	11 000	73,3	82,4	16 300	13 900	12 100	10 800	30,0
32,0	70,1	82,2	17 000	14 300	12 400	11 000	71,8	81,7	16 100	13 800	12 000	10 700	32,0
36,0	67,2	80,5	14 100	13 000	11 900	10 800	68,9	80,1	14 700	13 400	11 900	10 600	36,0
40,0	64,2	78,6	11 600	10 700	9 900	9 200	65,9	78,1	12 100	11 200	10 400	9 600	40,0
44,0	61,2	76,5	9 600	8 900	8 200	7 600	62,8	76,0	10 000	9 300	8 600	8 000	44,0
48,0	58,0	74,0	7 900	7 300	6 800	6 300	59,7	73,5	8 300	7 700	7 100	6 600	48,0
52,0	54,7	71,3	6 500	6 000	5 600	5 100	56,4	70,7	6 900	6 400	5 900	5 400	52,0
56,0	51,3	68,1	5 300	4 900	4 500	4 200	52,9	67,6	5 600	5 200	4 800	4 400	56,0
60,0	47,7	64,6	4 300	4 000	3 600	3 300	49,3	64,0	4 600	4 200	3 900	3 500	60,0
64,0	43,9	60,6	3 400	3 100	2 800	2 600	45,5	59,9	3 600	3 300	3 000	2 800	64,0
67,1	40,8	57,0	2 800	2 600	2 300	2 100	42,3	56,4	3 000	2 700	2 500	2 200	67,1
68,0	39,8	56,0	2 600	2 400	2 100	1 900	41,3	55,3	2 800	2 600	2 300	2 100	68,0
68,6	39,2	55,2	2 500	2 300	2 000	1 800	40,6	54,5	2 700	2 500	2 200	2 000	68,6
70,1	37,5	53,1	2 300	2 000	1 800		38,9	52,4	2 400	2 200	1 900		70,1
71,6	35,8	51,1	2 000	1 800			37,1	50,3	2 100	1 900			71,6
72,0							36,7	49,8	2 100				72,0
73,2							35,3	48,0	1 900				73,2

MLC250 S-2

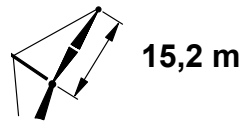
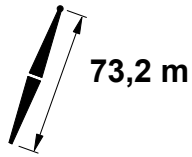

		5°						15°						
			0°	1°	2°	3°			0°	1°	2°	3°		
m	°	m	kg	kg	kg	kg	°	m	kg	kg	kg	kg	m	
18,3	80,1	89,2	18 800										18,3	
19,8	79,0	88,9	18 500	15 300			80,8	88,5	17 200				19,8	
20,0	78,9	88,9	18 500	15 300			80,6	88,4	17 200				20,0	
21,3	78,0	88,6	18 300	15 200	13 000		79,8	88,1	17 100	14 300			21,3	
22,0	77,6	88,4	18 300	15 100	12 900		79,3	88,0	17 000	14 300			22,0	
22,9	77,0	88,2	18 100	15 000	12 900	10 700	78,7	87,8	17 000	14 200	12 300		22,9	
24,0	76,2	87,9	18 000	14 900	12 800	10 700	78,0	87,5	16 900	14 100	12 300		24,0	
24,4	76,0	87,8	17 900	14 900	12 800	10 600	77,7	87,4	16 800	14 100	12 200	10 200	24,4	
25,9	75,0	87,4	17 700	14 700	12 700	10 600	76,7	87,0	16 700	14 100	12 200	10 200	25,9	
26,0	74,9	87,4	17 700	14 700	12 700	10 600	76,6	86,9	16 700	14 000	12 200	10 200	26,0	
27,4	73,9	87,0	17 500	14 600	12 600	10 600	75,6	86,5	16 600	14 000	12 100	10 200	27,4	
28,0	73,5	86,8	17 500	14 500	12 600	10 600	75,2	86,3	16 500	13 900	12 100	10 200	28,0	
30,0	72,2	86,1	17 200	14 400	12 400	10 500	73,9	85,7	16 300	13 800	12 000	10 100	30,0	
32,0	70,8	85,4	17 000	14 200	12 300	10 500	72,5	85,0	16 100	13 700	12 000	10 100	32,0	
36,0	68,0	83,8	13 900	12 800	11 700	10 500	69,7	83,4	14 500	13 200	11 800	10 100	36,0	
40,0	65,2	82,0	11 400	10 500	9 700	8 900	66,8	81,5	11 900	11 000	10 200	9 400	40,0	
44,0	62,2	80,0	9 400	8 600	8 000	7 300	63,9	79,5	9 800	9 100	8 400	7 700	44,0	
48,0	59,2	77,6	7 700	7 100	6 500	6 000	60,9	77,1	8 100	7 500	6 900	6 400	48,0	
52,0	56,1	75,0	6 300	5 800	5 300	4 900	57,7	74,5	6 700	6 100	5 700	5 200	52,0	
56,0	52,9	72,1	5 100	4 700	4 300	3 900	54,5	71,5	5 400	5 000	4 600	4 200	56,0	
60,0	49,5	68,7	4 100	3 700	3 400	3 100	51,1	68,1	4 400	4 000	3 600	3 300	60,0	
64,0	46,0	65,0	3 200	2 900	2 600	2 300	47,5	64,4	3 400	3 100	2 800	2 500	64,0	
67,1	43,1	61,7	2 600	2 300	2 100	1 800	44,5	61,0	2 800	2 500	2 300	2 000	67,1	
68,0	42,2	60,7	2 400	2 200	1 900		43,6	60,0	2 600	2 300	2 100		68,0	
68,6	41,6	60,0	2 300	2 100	1 800		43,0	59,3	2 500	2 200	2 000		68,6	
70,1	40,0	58,1	2 100	1 800			41,5	57,4	2 200	2 000			70,1	
71,6	38,5	56,3	1 800				39,9	55,6	1 900				71,6	

MLC250 S-2

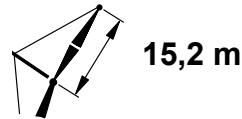
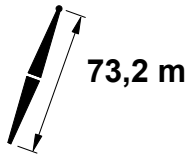
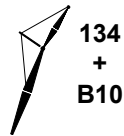

		25°					
		83 730 kg + 19 960 kg					
m	°	m	0° kg	1° kg	2° kg	3° kg	m
18,3							18,3
19,8							19,8
20,0							20,0
21,3							21,3
22,0							22,0
22,9	80,4	86,8	14 600				22,9
24,0	79,7	86,5	14 400				24,0
24,4	79,4	86,4	14 300	13 500			24,4
25,9	78,4	86,0	13 900	13 500	11 700		25,9
26,0	78,3	86,0	13 900	13 500	11 700		26,0
27,4	77,3	85,5	13 600	13 400	11 700	9 100	27,4
28,0	76,9	85,3	13 500	13 300	11 700	9 100	28,0
30,0	75,5	84,7	13 100	13 000	11 700	9 100	30,0
32,0	74,1	84,0	12 700	12 600	11 700	9 100	32,0
36,0	71,3	82,3	12 000	11 900	11 600	9 100	36,0
40,0	68,4	80,5	11 400	11 200	10 600	9 100	40,0
44,0	65,4	78,4	10 300	9 500	8 800	8 100	44,0
48,0	62,3	76,0	8 500	7 900	7 300	6 700	48,0
52,0	59,2	73,3	7 000	6 500	6 000	5 500	52,0
56,0	55,9	70,3	5 700	5 300	4 800	4 400	56,0
60,0	52,4	66,9	4 600	4 200	3 900	3 500	60,0
64,0	48,7	63,0	3 600	3 300	3 000	2 700	64,0
67,1	45,7	59,6	3 000	2 700	2 400	2 100	67,1
68,0	44,8	58,6	2 800	2 500	2 200	2 000	68,0
68,6	44,2	57,9	2 700	2 400	2 100	1 900	68,6
70,1	42,6	56,0	2 400	2 100	1 900		70,1
71,6							71,6

MLC250 S-2

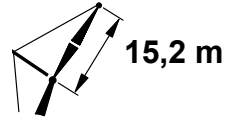
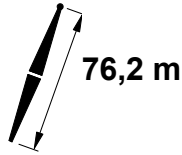
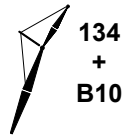

	5°			15°			
	m	°	m	kg	°	m	
18,3	80,4	92,3	18 600				18,3
20,0	79,3	92,0	18 400				20,0
21,3	78,4	91,7	18 200	80,1	91,3	17 000	21,3
22,0	78,0	91,6	18 100	79,7	91,1	16 900	22,0
22,9	77,4	91,4	18 000	79,1	90,9	16 900	22,9
24,0	76,7	91,1	17 900	78,4	90,6	16 800	24,0
26,0	75,4	90,6	17 600	77,1	90,1	16 600	26,0
28,0	74,1	90,0	17 400	75,8	89,5	16 500	28,0
30,0	72,8	89,3	17 200	74,4	88,9	16 300	30,0
32,0	71,5	88,7	16 900	73,1	88,2	16 100	32,0
36,0	68,8	87,1	14 000	70,4	86,7	14 600	36,0
40,0	66,1	85,4	11 400	67,7	84,9	12 000	40,0
44,0	63,3	83,4	9 400	64,8	82,9	9 900	44,0
48,0	60,4	81,2	7 800	61,9	80,7	8 200	48,0
52,0	57,4	78,7	6 400	59,0	78,2	6 700	52,0
56,0	54,4	75,9	5 200	55,9	75,3	5 500	56,0
60,0	51,2	72,7	4 200	52,7	72,2	4 400	60,0
64,0	47,8	69,2	3 300	49,3	68,6	3 500	64,0
68,0	44,3	65,2	2 500	45,7	64,6	2 700	68,0
71,6	40,9	61,1	1 800	42,3	60,5	2 000	71,6

MLC250 S-2

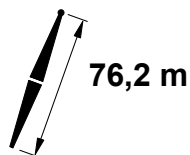

25°				
0°				
m	°	m	kg	m
18,3				18,3
20,0				20,0
21,3				21,3
22,0				22,0
22,9	80,8	89,9	14 800	22,9
24,0	80,0	89,7	14 500	24,0
26,0	78,7	89,1	14 000	26,0
28,0	77,4	88,5	13 600	28,0
30,0	76,1	87,9	13 200	30,0
32,0	74,7	87,2	12 800	32,0
36,0	72,0	85,6	12 200	36,0
40,0	69,2	83,9	11 600	40,0
44,0	66,3	81,9	10 300	44,0
48,0	63,4	79,6	8 500	48,0
52,0	60,4	77,0	7 000	52,0
56,0	57,2	74,2	5 800	56,0
60,0	54,0	70,9	4 700	60,0
64,0	50,5	67,3	3 700	64,0
68,0	46,9	63,2	2 800	68,0
71,6	43,3	59,0	2 100	71,6

MLC250 S-2

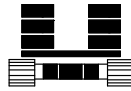
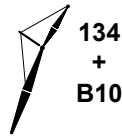

83 730 kg
+
19 960 kg

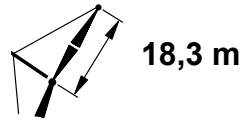
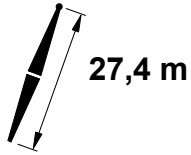

			5°				15°						
 m	 °	 m	 0° kg	 1° kg	 2° kg	 3° kg	 °	 m	 0° kg	 1° kg	 2° kg	 3° kg	 m
10,7	80,4	47,3	17 700										10,7
12,0	78,7	47,0	17 300										12,0
12,2	78,4	46,9	17 200	14 200	12 100								12,2
13,7	76,5	46,5	16 700	13 900	11 900	10 400	80,5	46,2	15 400				13,7
14,0	76,1	46,5	16 600	13 800	11 800	10 400	80,2	46,1	15 300				14,0
15,2	74,5	46,1	16 300	13 600	11 700	10 200	78,6	45,7	15 000	12 900	11 100		15,2
16,0	73,5	45,8	16 000	13 400	11 600	10 200	77,5	45,5	14 800	12 800	11 100		16,0
16,8	72,4	45,6	15 800	13 300	11 400	10 100	76,4	45,2	14 600	12 600	11 000	9 700	16,8
18,0	70,8	45,1	15 400	13 000	11 200	9 900	74,8	44,7	14 300	12 400	10 900	9 600	18,0
18,3	70,4	45,0	15 300	13 000	11 200	9 900	74,4	44,6	14 200	12 400	10 800	9 600	18,3
19,8	68,4	44,4	14 800	12 700	11 000	9 700	72,4	44,0	13 900	12 100	10 700	9 500	19,8
20,0	68,1	44,3	14 800	12 700	11 000	9 700	72,1	43,9	13 900	12 100	10 700	9 400	20,0
22,0	65,3	43,4	14 300	12 300	10 700	9 500	69,3	43,0	13 400	11 800	10 400	9 300	22,0
24,0	62,5	42,3	13 800	12 000	10 500	9 300	66,4	41,9	12 700	11 500	10 200	9 200	24,0
26,0	59,6	41,1	13 300	11 600	10 300	9 100	63,5	40,7	11 800	11 200	10 100	9 000	26,0
28,0	56,6	39,8	12 900	11 300	10 000	9 000	60,4	39,3	11 100	10 900	9 900	8 900	28,0
30,0	53,4	38,2	12 500	11 000	9 800	8 800	57,2	37,8	10 500	10 400	9 700	8 800	30,0
32,0	50,1	36,6	11 900	10 700	9 600	8 700	53,9	36,1	9 900	9 900	9 500	8 600	32,0
36,0	43,0	32,5	10 500	10 200	9 200	8 400	46,6	32,0	9 000	8 900	8 800	8 400	36,0
39,6	35,4	27,7	9 600	9 400	8 900	8 200	38,9	27,0	8 300	8 300	8 200	8 100	39,6
40,0	34,6	27,2	9 500	9 400	8 900	8 100	38,1	26,5	8 200	8 200	8 100	8 100	40,0
42,7	27,3	22,0	8 900	8 800	8 600	8 000	31,0	21,6	7 800	7 800	7 800	7 700	42,7
44,0	23,6	19,4	8 600	8 500	8 500	8 000							44,0
44,2	22,9	18,9	8 500	8 500	8 400	8 000							44,2

MLC250 S-2



83 730 kg
+
19 960 kg

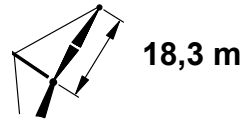
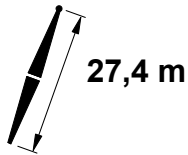

		25°					
		83 730 kg + 19 960 kg					
m	°	m	0° kg	1° kg	2° kg	3° kg	m
10,7							10,7
12,0							12,0
12,2							12,2
13,7							13,7
14,0							14,0
15,2							15,2
16,0							16,0
16,8	80,6	44,4	12 200				16,8
18,0	78,9	43,9	11 700				18,0
18,3	78,5	43,8	11 600	11 400	10 400		18,3
19,8	76,4	43,1	11 000	10 800	10 200	9 200	19,8
20,0	76,1	43,0	10 900	10 800	10 200	9 100	20,0
22,0	73,3	42,1	10 200	10 100	9 900	9 100	22,0
24,0	70,3	41,0	9 700	9 600	9 400	9 000	24,0
26,0	67,3	39,7	9 100	9 000	8 900	8 800	26,0
28,0	64,2	38,3	8 700	8 600	8 500	8 400	28,0
30,0	60,9	36,8	8 300	8 200	8 100	8 000	30,0
32,0	57,5	35,0	8 000	7 900	7 800	7 700	32,0
36,0	49,9	30,7	7 300	7 300	7 200	7 200	36,0
39,6	41,9	25,6	6 900	6 900	6 800	6 800	39,6
40,0							40,0
42,7							42,7
44,0							44,0
44,2							44,2

MLC250 S-2

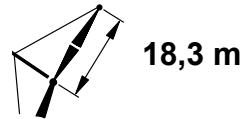
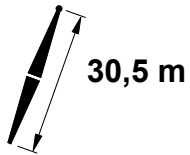
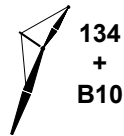

				25°					
				0°	1°	2°	3°		
				kg	kg	kg	kg		
				kg	kg	kg	kg		
				kg	kg	kg	kg		
				kg	kg	kg	kg		
				kg	kg	kg	kg		
				kg	kg	kg	kg		
				kg	kg	kg	kg		
				kg	kg	kg	kg		
				kg	kg	kg	kg		
				kg	kg	kg	kg		
				kg	kg	kg	kg		
				kg	kg	kg	kg		
				kg	kg	kg	kg		
				kg	kg	kg	kg		
				kg	kg	kg	kg		
				kg	kg	kg	kg		
				kg	kg	kg	kg		
				kg	kg	kg	kg		
				kg	kg	kg	kg		
				kg	kg	kg	kg		
				kg	kg	kg	kg		
				kg	kg	kg	kg		
				kg	kg	kg	kg		
				kg	kg	kg	kg		
				kg	kg	kg	kg		
				kg	kg	kg	kg		
				kg	kg	kg	kg		
				kg	kg	kg	kg		
				kg	kg	kg	kg		
				kg	kg	kg	kg		
				kg	kg	kg	kg		
				kg	kg	kg	kg		
				kg	kg	kg	kg		
				kg	kg	kg	kg		
				kg	kg	kg	kg		
				kg	kg	kg	kg		
				kg	kg	kg	kg		
				kg	kg	kg	kg		
				kg	kg	kg	kg		
				kg	kg	kg	kg		
				kg	kg	kg	kg		
				kg	kg	kg	kg		
				kg	kg	kg	kg		
				kg	kg	kg	kg		
				kg	kg	kg	kg		
				kg	kg	kg	kg		
				kg	kg	kg	kg		
				kg	kg	kg	kg		
				kg	kg	kg	kg		
				kg	kg	kg	kg		
				kg	kg	kg	kg		
				kg	kg	kg	kg		
				kg	kg	kg	kg		
				kg	kg	kg	kg		
				kg	kg	kg	kg		
				kg	kg	kg	kg		
				kg	kg	kg	kg		
				kg	kg	kg	kg		
				kg	kg	kg	kg		
				kg	kg	kg	kg		
				kg	kg	kg	kg		
				kg	kg	kg	kg		
				kg	kg	kg	kg		
				kg	kg	kg	kg		
				kg	kg	kg	kg		
				kg	kg	kg	kg		
				kg	kg	kg	kg		
				kg	kg	kg	kg		
				kg	kg	kg	kg		
				kg	kg	kg	kg		
				kg	kg	kg	kg		
				kg	kg	kg	kg		
				kg	kg	kg	kg		
				kg	kg	kg	kg		
				kg	kg	kg	kg		
				kg	kg	kg	kg		
				kg	kg	kg	kg		
				kg	kg	kg	kg		
				kg	kg	kg	kg		
				kg	kg	kg	kg		
				kg	kg	kg	kg		
				kg	kg	kg	kg		
				kg	kg	kg	kg		
				kg	kg	kg	kg		
				kg	kg	kg	kg		
				kg	kg	kg	kg		
				kg	kg	kg	kg		
				kg	kg	kg	kg		

MLC250 S-2



83 730 kg
+
19 960 kg

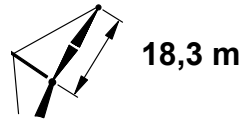
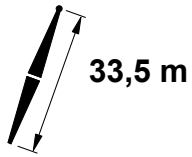

		5°						15°						
			0°	1°	2°	3°			0°	1°	2°	3°		
m	°	m	kg	kg	kg	kg	°	m	kg	kg	kg	kg	m	
12,2	79,8	53,2	17 400	14 300									12,2	
13,7	78,1	52,8	17 000	14 000									13,7	
14,0	77,8	52,8	16 900	14 000	12 000								14,0	
15,2	76,4	52,4	16 600	13 800	11 800	10 300	79,9	52,0	15 200	13 000			15,2	
16,0	75,5	52,2	16 400	13 600	11 700	10 300	79,0	51,8	15 000	12 900			16,0	
16,8	74,6	52,0	16 200	13 500	11 600	10 200	78,1	51,6	14 800	12 800	11 100		16,8	
18,0	73,2	51,6	15 800	13 300	11 400	10 000	76,7	51,2	14 600	12 600	10 900		18,0	
18,3	72,8	51,5	15 700	13 200	11 400	10 000	76,3	51,1	14 500	12 500	10 900	9 700	18,3	
19,8	71,1	51,0	15 300	13 000	11 200	9 900	74,6	50,5	14 200	12 300	10 800	9 500	19,8	
20,0	70,8	50,9	15 300	12 900	11 200	9 900	74,3	50,5	14 200	12 300	10 800	9 500	20,0	
21,3	69,3	50,4	15 000	12 700	11 000	9 700	72,8	49,9	13 900	12 100	10 700	9 400	21,3	
22,0	68,4	50,1	14 800	12 600	10 900	9 700	71,9	49,7	13 800	12 000	10 600	9 400	22,0	
24,0	66,0	49,2	14 300	12 300	10 700	9 500	69,5	48,7	13 400	11 800	10 400	9 300	24,0	
26,0	63,5	48,1	13 900	12 000	10 500	9 300	67,0	47,7	12 800	11 500	10 300	9 200	26,0	
28,0	61,0	47,0	13 400	11 700	10 300	9 200	64,4	46,6	12 100	11 300	10 100	9 100	28,0	
30,0	58,4	45,8	13 100	11 400	10 100	9 000	61,8	45,3	11 400	11 000	9 900	8 900	30,0	
32,0	55,7	44,4	12 700	11 200	9 900	8 900	59,0	43,9	10 800	10 800	9 800	8 800	32,0	
36,0	50,0	41,2	11 900	10 700	9 600	8 600	53,3	40,6	9 800	9 800	9 500	8 600	36,0	
40,0	43,7	37,2	10 700	10 200	9 200	8 300	47,0	36,6	9 000	9 000	8 900	8 400	40,0	
44,0	36,6	32,1	9 700	9 600	8 900	8 200	39,7	31,5	8 300	8 300	8 200	8 200	44,0	
44,2	36,2	31,8	9 600	9 600	8 900	8 200	39,3	31,1	8 300	8 300	8 200	8 200	44,2	
47,2	29,6	26,6	9 000	8 900	8 700	8 000	32,6	26,0	7 900	7 900	7 800	7 800	47,2	
48,0	27,9	25,4	8 800	8 800	8 700	8 000							48,0	
50,3	21,4	20,0	8 400	8 400	8 300	8 000							50,3	

MLC250 S-2

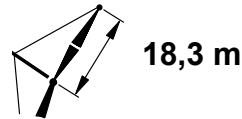
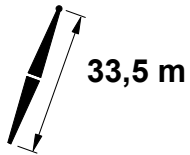
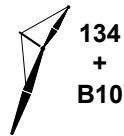

				25°					
				0°	1°	2°	3°		
				kg	kg	kg	kg		
				kg	kg	kg	kg		
				kg	kg	kg	kg		
				kg	kg	kg	kg		
				kg	kg	kg	kg		
				kg	kg	kg	kg		
				kg	kg	kg	kg		
				kg	kg	kg	kg		
				kg	kg	kg	kg		
				kg	kg	kg	kg		
				kg	kg	kg	kg		
				kg	kg	kg	kg		
				kg	kg	kg	kg		
				kg	kg	kg	kg		
				kg	kg	kg	kg		
				kg	kg	kg	kg		
				kg	kg	kg	kg		
				kg	kg	kg	kg		
				kg	kg	kg	kg		
				kg	kg	kg	kg		
				kg	kg	kg	kg		
				kg	kg	kg	kg		
				kg	kg	kg	kg		
				kg	kg	kg	kg		
				kg	kg	kg	kg		
				kg	kg	kg	kg		
				kg	kg	kg	kg		
				kg	kg	kg	kg		
				kg	kg	kg	kg		
				kg	kg	kg	kg		
				kg	kg	kg	kg		
				kg	kg	kg	kg		
				kg	kg	kg	kg		
				kg	kg	kg	kg		
				kg	kg	kg	kg		
				kg	kg	kg	kg		
				kg	kg	kg	kg		
				kg	kg	kg	kg		
				kg	kg	kg	kg		
				kg	kg	kg	kg		
				kg	kg	kg	kg		
				kg	kg	kg	kg		
				kg	kg	kg	kg		
				kg	kg	kg	kg		
				kg	kg	kg	kg		
				kg	kg	kg	kg		
				kg	kg	kg	kg		
				kg	kg	kg	kg		
				kg	kg	kg	kg		
				kg	kg	kg	kg		
				kg	kg	kg	kg		
				kg	kg	kg	kg		
				kg	kg	kg	kg		
				kg	kg	kg	kg		
				kg	kg	kg	kg		
				kg	kg	kg	kg		
				kg	kg	kg	kg		
				kg	kg	kg	kg		
				kg	kg	kg	kg		
				kg	kg	kg	kg		
				kg	kg	kg	kg		
				kg	kg	kg	kg		
				kg	kg	kg	kg		
				kg	kg	kg	kg		
				kg	kg	kg	kg		
				kg	kg	kg	kg		
				kg	kg	kg	kg		
				kg	kg	kg	kg		
				kg	kg	kg	kg		
				kg	kg	kg	kg		
				kg	kg	kg	kg		
				kg	kg	kg	kg		
				kg	kg	kg	kg		
				kg	kg	kg	kg		
				kg	kg	kg	kg		
				kg	kg	kg	kg		
				kg	kg	kg	kg		
				kg	kg	kg	kg		
				kg	kg	kg	kg		
				kg	kg	kg	kg		
				kg	kg	kg	kg		
				kg	kg	kg	kg		
				kg	kg	kg	kg		
				kg	kg	kg	kg		
				kg	kg	kg	kg		
				kg	kg	kg	kg		
				kg	kg	kg	kg		
				kg	kg	kg	kg		

MLC250 S-2



83 730 kg
+
19 960 kg

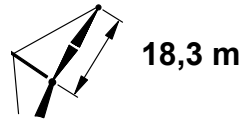
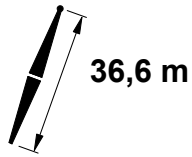

		5°						15°						
			0°	1°	2°	3°			0°	1°	2°	3°		
m	°	m	kg	kg	kg	kg	°	m	kg	kg	kg	kg	m	
12,2	80,4	56,3	17 500										12,2	
13,7	78,8	56,0	17 100	14 100	12 000								13,7	
14,0	78,5	55,9	17 000	14 000	12 000								14,0	
15,2	77,2	55,6	16 700	13 800	11 800	10 400	80,5	55,2	15 300				15,2	
16,0	76,3	55,4	16 500	13 700	11 700	10 300	79,7	55,0	15 100				16,0	
16,8	75,4	55,2	16 300	13 500	11 600	10 200	78,8	54,7	14 900	12 800	11 100		16,8	
18,0	74,1	54,8	16 000	13 300	11 500	10 100	77,5	54,4	14 700	12 600	11 000		18,0	
18,3	73,8	54,7	15 900	13 300	11 400	10 000	77,1	54,3	14 600	12 600	11 000	9 700	18,3	
19,8	72,2	54,2	15 500	13 100	11 300	9 900	75,5	53,8	14 400	12 400	10 800	9 600	19,8	
20,0	71,9	54,1	15 500	13 100	11 300	9 900	75,3	53,7	14 300	12 400	10 800	9 600	20,0	
21,3	70,5	53,6	15 200	12 900	11 100	9 800	73,8	53,2	14 100	12 200	10 700	9 500	21,3	
22,0	69,7	53,4	15 000	12 800	11 000	9 700	73,0	53,0	13 900	12 100	10 700	9 400	22,0	
24,0	67,4	52,5	14 500	12 500	10 800	9 500	70,7	52,1	13 600	11 900	10 500	9 300	24,0	
26,0	65,1	51,6	14 100	12 200	10 600	9 400	68,4	51,1	13 300	11 600	10 300	9 200	26,0	
28,0	62,8	50,5	13 700	11 900	10 400	9 200	66,0	50,1	12 500	11 400	10 200	9 100	28,0	
30,0	60,3	49,4	13 300	11 600	10 200	9 100	63,6	48,9	11 900	11 200	10 000	9 000	30,0	
32,0	57,9	48,1	13 000	11 300	10 000	9 000	61,1	47,6	11 300	11 000	9 900	8 900	32,0	
36,0	52,7	45,1	12 300	10 900	9 700	8 700	55,8	44,6	10 200	10 200	9 600	8 700	36,0	
40,0	47,1	41,6	11 200	10 400	9 400	8 500	50,1	41,0	9 400	9 300	9 200	8 500	40,0	
44,0	40,9	37,2	10 200	10 000	9 100	8 300	43,8	36,6	8 700	8 700	8 600	8 400	44,0	
45,7	37,8	34,8	9 800	9 700	9 000	8 200	40,7	34,1	8 400	8 400	8 300	8 200	45,7	
48,0	33,7	31,6	9 300	9 300	8 800	8 100	36,5	30,9	8 100	8 100	8 000	8 000	48,0	
50,3	28,5	27,2	8 900	8 900	8 600	8 000	31,5	26,7	7 800	7 800	7 800	7 800	50,3	
52,0	24,7	23,9	8 600	8 500	8 500	8 000							52,0	
53,3	20,8	20,5	8 400	8 400	8 300	8 000							53,3	

MLC250 S-2

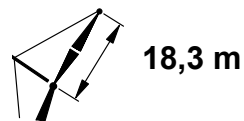
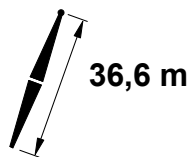

		25°					
		83 730 kg + 19 960 kg					
m	°	m	0° kg	1° kg	2° kg	3° kg	m
12,2							12,2
13,7							13,7
14,0							14,0
15,2							15,2
16,0							16,0
16,8							16,8
18,0							18,0
18,3	80,6	53,4	12 200				18,3
19,8	78,9	52,8	11 600	11 500	10 400		19,8
20,0	78,7	52,8	11 600	11 400	10 300		20,0
21,3	77,2	52,3	11 200	11 000	10 300	9 100	21,3
22,0	76,4	52,0	11 000	10 800	10 200	9 100	22,0
24,0	74,0	51,1	10 400	10 300	10 000	9 100	24,0
26,0	71,6	50,1	9 900	9 800	9 600	9 000	26,0
28,0	69,2	49,1	9 500	9 400	9 200	8 900	28,0
30,0	66,7	47,9	9 100	9 000	8 800	8 700	30,0
32,0	64,2	46,6	8 700	8 600	8 500	8 400	32,0
36,0	58,8	43,5	8 100	8 000	7 900	7 800	36,0
40,0	52,9	39,8	7 600	7 500	7 400	7 300	40,0
44,0	46,4	35,1	7 100	7 100	7 000	7 000	44,0
45,7	43,2	32,8	7 000	6 900	6 900	6 900	45,7
48,0							48,0
50,3							50,3
52,0							52,0
53,3							53,3

MLC250 S-2

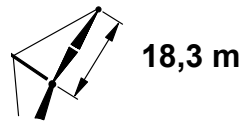
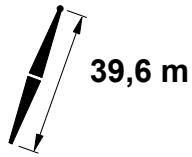

		5°						15°						
			0°	1°	2°	3°			0°	1°	2°	3°		
m	°	m	kg	kg	kg	kg	°	m	kg	kg	kg	kg	m	
12,2	80,9	59,4	17 500										12,2	
13,7	79,4	59,1	17 100	14 100									13,7	
14,0	79,1	59,0	17 100	14 100									14,0	
15,2	77,9	58,7	16 800	13 900	11 900	10 300	81,0	58,3	15 400				15,2	
16,0	77,1	58,5	16 600	13 700	11 800	10 300	80,2	58,1	15 200				16,0	
16,8	76,2	58,3	16 400	13 600	11 700	10 200	79,4	57,9	15 000	12 800			16,8	
18,0	75,0	58,0	16 100	13 400	11 500	10 100	78,2	57,6	14 800	12 700			18,0	
18,3	74,7	57,9	16 100	13 400	11 500	10 100	77,9	57,5	14 700	12 700	11 000	9 700	18,3	
19,8	73,1	57,4	15 700	13 200	11 300	10 000	76,3	57,0	14 500	12 500	10 900	9 600	19,8	
20,0	72,9	57,4	15 700	13 100	11 300	9 900	76,1	56,9	14 400	12 500	10 900	9 600	20,0	
21,3	71,6	56,9	15 400	12 900	11 200	9 800	74,7	56,5	14 200	12 300	10 800	9 500	21,3	
22,0	70,8	56,6	15 200	12 800	11 100	9 800	74,0	56,2	14 100	12 200	10 700	9 500	22,0	
24,0	68,7	55,8	14 700	12 600	10 900	9 600	71,8	55,4	13 700	12 000	10 500	9 400	24,0	
26,0	66,5	55,0	14 300	12 300	10 700	9 400	69,6	54,5	13 400	11 700	10 400	9 200	26,0	
28,0	64,3	54,0	13 900	12 000	10 500	9 300	67,4	53,5	12 900	11 500	10 200	9 200	28,0	
30,0	62,1	52,9	13 500	11 800	10 300	9 200	65,1	52,4	12 300	11 300	10 100	9 100	30,0	
32,0	59,8	51,7	13 200	11 500	10 200	9 000	62,8	51,2	11 600	11 100	10 000	8 900	32,0	
36,0	55,0	49,0	12 600	11 000	9 800	8 800	58,0	48,5	10 600	10 600	9 700	8 800	36,0	
40,0	49,9	45,8	11 800	10 600	9 500	8 500	52,8	45,2	9 800	9 700	9 400	8 600	40,0	
44,0	44,3	41,8	10 700	10 200	9 200	8 300	47,2	41,2	9 000	9 000	8 900	8 400	44,0	
48,0	38,1	37,0	9 800	9 800	8 900	8 200	40,9	36,3	8 400	8 400	8 300	8 300	48,0	
48,8	36,7	35,8	9 700	9 500	8 800	8 100	39,4	35,1	8 300	8 300	8 200	8 200	48,8	
52,0	30,9	30,8	8 900	8 600	8 400	8 000	33,4	30,0	7 900	7 900	7 900	7 800	52,0	
53,3	27,7	27,9	8 500	8 300	8 000	7 700	30,5	27,4	7 800	7 800	7 800	7 700	53,3	
56,0	21,3	22,1	7 700	7 500	7 300	7 100							56,0	
56,4	20,2	21,0	7 600	7 400	7 200	7 000							56,4	

MLC250 S-2

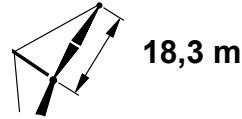
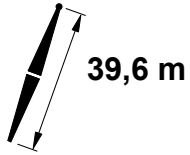
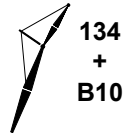

				25°					
				0°	1°	2°	3°		
				kg	kg	kg	kg		
				kg	kg	kg	kg		
				kg	kg	kg	kg		
				kg	kg	kg	kg		
				kg	kg	kg	kg		
				kg	kg	kg	kg		
				kg	kg	kg	kg		
				kg	kg	kg	kg		
				kg	kg	kg	kg		
				kg	kg	kg	kg		
				kg	kg	kg	kg		
				kg	kg	kg	kg		
				kg	kg	kg	kg		
				kg	kg	kg	kg		
				kg	kg	kg	kg		
				kg	kg	kg	kg		
				kg	kg	kg	kg		
				kg	kg	kg	kg		
				kg	kg	kg	kg		
				kg	kg	kg	kg		
				kg	kg	kg	kg		
				kg	kg	kg	kg		
				kg	kg	kg	kg		
				kg	kg	kg	kg		
				kg	kg	kg	kg		
				kg	kg	kg	kg		
				kg	kg	kg	kg		
				kg	kg	kg	kg		
				kg	kg	kg	kg		
				kg	kg	kg	kg		
				kg	kg	kg	kg		
				kg	kg	kg	kg		
				kg	kg	kg	kg		
				kg	kg	kg	kg		
				kg	kg	kg	kg		
				kg	kg	kg	kg		
				kg	kg	kg	kg		
				kg	kg	kg	kg		
				kg	kg	kg	kg		
				kg	kg	kg	kg		
				kg	kg	kg	kg		
				kg	kg	kg	kg		
				kg	kg	kg	kg		
				kg	kg	kg	kg		
				kg	kg	kg	kg		
				kg	kg	kg	kg		
				kg	kg	kg	kg		
				kg	kg	kg	kg		
				kg	kg	kg	kg		
				kg	kg	kg	kg		
				kg	kg	kg	kg		
				kg	kg	kg	kg		
				kg	kg	kg	kg		
				kg	kg	kg	kg		
				kg	kg	kg	kg		
				kg	kg	kg	kg		
				kg	kg	kg	kg		
				kg	kg	kg	kg		
				kg	kg	kg	kg		
				kg	kg	kg	kg		
				kg	kg	kg	kg		
				kg	kg	kg	kg		
				kg	kg	kg	kg		
				kg	kg	kg	kg		
				kg	kg	kg	kg		
				kg	kg	kg	kg		
				kg	kg	kg	kg		
				kg	kg	kg	kg		
				kg	kg	kg	kg		
				kg	kg	kg	kg		
				kg	kg	kg	kg		
				kg	kg	kg	kg		
				kg	kg	kg	kg		
				kg	kg	kg	kg		
				kg	kg	kg	kg		
				kg	kg	kg	kg		
				kg	kg	kg	kg		
				kg	kg	kg	kg		
				kg	kg	kg	kg		
				kg	kg	kg	kg		
				kg	kg	kg	kg		
				kg	kg	kg	kg		
				kg	kg	kg	kg		
				kg	kg	kg	kg		
				kg	kg	kg	kg		
				kg	kg	kg	kg		
				kg	kg	kg	kg		
				kg	kg	kg	kg		

MLC250 S-2

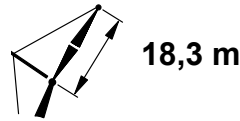
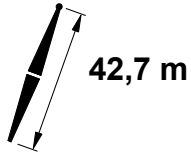
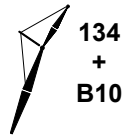

		5°						15°						
			0°	1°	2°	3°			0°	1°	2°	3°		
m	°	m	kg	kg	kg	kg	°	m	kg	kg	kg	kg	m	
13,7	79,9	62,2	17 200	14 100									13,7	
14,0	79,6	62,1	17 100	14 100									14,0	
15,2	78,5	61,9	16 800	13 900	11 800								15,2	
16,0	77,7	61,7	16 700	13 800	11 800								16,0	
16,8	76,9	61,5	16 500	13 600	11 700	10 200	80,0	61,1	15 100				16,8	
18,0	75,8	61,2	16 300	13 500	11 500	10 100	78,8	60,7	14 900				18,0	
18,3	75,5	61,1	16 200	13 400	11 500	10 100	78,5	60,6	14 800	12 700	11 000		18,3	
19,8	74,0	60,6	15 800	13 200	11 400	10 000	77,0	60,2	14 600	12 500	10 900	9 600	19,8	
20,0	73,8	60,6	15 800	13 200	11 300	10 000	76,8	60,1	14 500	12 500	10 900	9 600	20,0	
21,3	72,5	60,1	15 500	13 000	11 200	9 900	75,5	59,7	14 300	12 400	10 800	9 500	21,3	
22,0	71,8	59,9	15 300	12 900	11 100	9 800	74,8	59,5	14 200	12 300	10 700	9 500	22,0	
22,9	70,9	59,5	15 200	12 800	11 000	9 700	73,9	59,1	14 000	12 200	10 700	9 400	22,9	
24,0	69,8	59,1	14 900	12 700	10 900	9 600	72,8	58,7	13 800	12 100	10 600	9 400	24,0	
26,0	67,8	58,3	14 500	12 400	10 800	9 500	70,7	57,9	13 600	11 800	10 400	9 300	26,0	
28,0	65,7	57,4	14 100	12 100	10 600	9 400	68,6	56,9	13 200	11 600	10 300	9 200	28,0	
30,0	63,6	56,4	13 700	11 900	10 400	9 200	66,5	55,9	12 700	11 400	10 200	9 100	30,0	
32,0	61,5	55,3	13 400	11 700	10 200	9 100	64,4	54,8	12 000	11 200	10 000	9 000	32,0	
36,0	57,0	52,7	12 800	11 200	9 900	8 800	59,9	52,2	11 000	10 900	9 800	8 800	36,0	
40,0	52,3	49,8	12 200	10 800	9 600	8 600	55,1	49,2	10 100	10 100	9 500	8 600	40,0	
44,0	47,3	46,2	11 300	10 400	9 300	8 400	50,0	45,6	9 400	9 300	9 200	8 500	44,0	
48,0	41,8	41,9	10 100	9 800	9 100	8 200	44,4	41,3	8 800	8 700	8 600	8 400	48,0	
50,3	38,2	38,9	9 300	9 000	8 500	8 000	40,8	38,2	8 500	8 400	8 300	8 200	50,3	
52,0	35,5	36,6	8 700	8 400	8 200	7 900	38,1	35,9	8 200	8 200	8 100	8 000	52,0	
54,9	30,2	31,7	7 900	7 600	7 400	7 100	32,8	31,1	7 900	7 800	7 500	7 300	54,9	
56,0	28,1	29,8	7 500	7 300	7 100	6 900							56,0	
57,9	23,7	25,6	7 000	6 800	6 600	6 400							57,9	

MLC250 S-2

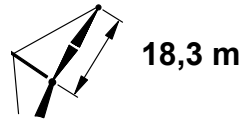
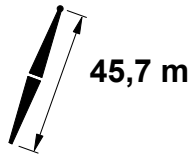

		5°						15°						
			0°	1°	2°	3°				0°	1°	2°	3°	
	m	°	m	kg	kg	kg	kg	°	m	kg	kg	kg	kg	m
13,7	80,4	65,3	17 200											13,7
14,0	80,1	65,3	17 100											14,0
15,2	79,0	65,0	16 900	13 900										15,2
16,0	78,3	64,8	16 700	13 800										16,0
16,8	77,6	64,6	16 600	13 700	11 700	10 200		80,5	64,2	15 200				16,8
18,0	76,5	64,3	16 300	13 500	11 600	10 100	79,3	63,9	14 900					18,0
18,3	76,2	64,2	16 300	13 400	11 500	10 100	79,1	63,8	14 900	12 700				18,3
19,8	74,8	63,8	16 000	13 300	11 400	10 000	77,6	63,4	14 600	12 500	10 900	9 600		19,8
20,0	74,6	63,8	15 900	13 200	11 400	10 000	77,5	63,3	14 600	12 500	10 900	9 600		20,0
21,3	73,4	63,3	15 600	13 100	11 200	9 900	76,2	62,9	14 400	12 400	10 800	9 500		21,3
22,0	72,7	63,1	15 500	13 000	11 200	9 800	75,6	62,7	14 300	12 300	10 700	9 500		22,0
22,9	71,9	62,8	15 300	12 900	11 100	9 700	74,7	62,3	14 100	12 200	10 700	9 400		22,9
24,0	70,8	62,4	15 100	12 700	11 000	9 700	73,7	62,0	14 000	12 100	10 600	9 400		24,0
26,0	68,9	61,6	14 700	12 500	10 800	9 500	71,7	61,2	13 700	11 900	10 500	9 300		26,0
28,0	67,0	60,7	14 300	12 200	10 600	9 400	69,8	60,3	13 400	11 700	10 300	9 200		28,0
30,0	65,0	59,8	13 900	12 000	10 500	9 300	67,8	59,3	13 000	11 500	10 200	9 100		30,0
32,0	62,9	58,8	13 600	11 800	10 300	9 100	65,7	58,3	12 400	11 300	10 100	9 000		32,0
36,0	58,8	56,4	13 000	11 300	10 000	8 900	61,5	55,9	11 300	11 000	9 800	8 800		36,0
40,0	54,4	53,6	12 400	10 900	9 700	8 700	57,1	53,1	10 500	10 400	9 600	8 700		40,0
44,0	49,8	50,3	11 500	10 500	9 400	8 500	52,4	49,8	9 700	9 700	9 400	8 600		44,0
48,0	44,8	46,5	9 900	9 500	9 000	8 300	47,4	45,9	9 100	9 000	8 900	8 400		48,0
51,8	39,6	42,0	8 500	8 200	7 900	7 600	42,0	41,3	8 500	8 400	8 100	7 800		51,8
52,0	39,3	41,8	8 500	8 100	7 800	7 500	41,8	41,1	8 500	8 400	8 000	7 700		52,0
56,0	33,0	36,1	7 300	7 000	6 800	6 500	35,4	35,3	7 400	7 200	6 900	6 700		56,0
57,9	29,4	32,4	6 800	6 500	6 300	6 100	31,9	31,8	6 900	6 700	6 400	6 200		57,9
60,0	25,3	28,5	6 200	6 000	5 800	5 600								60,0
61,0	23,1	26,2	6 000	5 800	5 600	5 400								61,0

MLC250 S-2

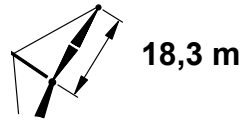
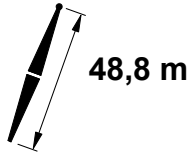
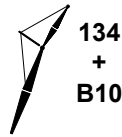

		5°						15°						
	m	°	m	kg	kg	kg	kg	°	m	kg	kg	kg	kg	m
13,7	80,9	68,4	17 200											13,7
14,0	80,6	68,4	17 200											14,0
15,2	79,5	68,1	16 900	13 900										15,2
16,0	78,9	67,9	16 800	13 800										16,0
16,8	78,1	67,8	16 600	13 700	11 700			80,9	67,3	15 200				16,8
18,0	77,1	67,5	16 400	13 500	11 600			79,8	67,0	15 000				18,0
18,3	76,8	67,4	16 300	13 500	11 500	10 100		79,6	66,9	14 900	12 700			18,3
19,8	75,5	67,0	16 000	13 300	11 400	10 000		78,2	66,5	14 700	12 600	10 900		19,8
20,0	75,3	66,9	16 000	13 300	11 400	10 000		78,1	66,5	14 700	12 500	10 900		20,0
21,3	74,2	66,5	15 700	13 100	11 200	9 900		76,9	66,1	14 500	12 400	10 800	9 500	21,3
22,0	73,5	66,3	15 600	13 000	11 200	9 800		76,3	65,9	14 300	12 400	10 700	9 500	22,0
22,9	72,7	66,0	15 400	12 900	11 100	9 800		75,4	65,6	14 200	12 300	10 700	9 400	22,9
24,0	71,7	65,6	15 200	12 800	11 000	9 700		74,4	65,2	14 100	12 200	10 600	9 400	24,0
24,4	71,4	65,5	15 100	12 700	11 000	9 700		74,1	65,0	14 000	12 100	10 600	9 400	24,4
26,0	69,9	64,9	14 800	12 500	10 800	9 500		72,6	64,4	13 800	11 900	10 500	9 300	26,0
28,0	68,1	64,1	14 400	12 300	10 700	9 400		70,7	63,6	13 500	11 800	10 400	9 200	28,0
30,0	66,2	63,2	14 100	12 100	10 500	9 300		68,9	62,7	13 300	11 600	10 300	9 100	30,0
32,0	64,3	62,2	13 800	11 900	10 400	9 200		66,9	61,7	12 800	11 400	10 100	9 000	32,0
36,0	60,4	60,0	13 200	11 500	10 100	8 900		63,0	59,5	11 700	11 100	9 900	8 900	36,0
40,0	56,3	57,4	12 600	11 000	9 800	8 700		58,9	56,9	10 800	10 700	9 700	8 700	40,0
44,0	52,0	54,4	11 300	10 700	9 500	8 500		54,5	53,8	10 000	10 000	9 500	8 600	44,0
48,0	47,4	50,8	9 700	9 200	8 800	8 300		49,9	50,2	9 400	9 300	9 100	8 500	48,0
52,0	42,5	46,6	8 300	7 900	7 600	7 300		44,9	46,0	8 500	8 200	7 800	7 500	52,0
54,9	38,5	43,0	7 400	7 100	6 800	6 500		40,9	42,3	7 600	7 300	7 000	6 700	54,9
56,0	37,0	41,6	7 100	6 800	6 500	6 300		39,3	40,8	7 300	7 000	6 700	6 400	56,0
60,0	30,6	35,3	6 100	5 800	5 600	5 400		32,8	34,4	6 200	6 000	5 700	5 500	60,0
61,0	28,7	33,2	5 800	5 600	5 400	5 200		31,0	32,6	6 000	5 700	5 500	5 300	61,0
64,0	22,6	26,8	5 100	5 000	4 800	4 600								64,0

MLC250 S-2

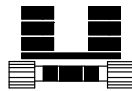

83 730 kg
+
19 960 kg

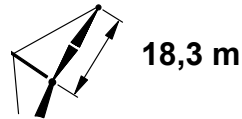
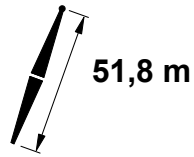

		5°						15°						
			0°	1°	2°	3°			0°	1°	2°	3°		
m	°	m	kg	kg	kg	kg	°	m	kg	kg	kg	kg	m	
15,2	80,0	71,2	16 900	13 900									15,2	
16,0	79,3	71,1	16 800	13 800									16,0	
16,8	78,7	70,9	16 600	13 700	11 700								16,8	
18,0	77,7	70,6	16 400	13 500	11 600								18,0	
18,3	77,4	70,5	16 300	13 500	11 500	10 000	80,1	70,1	15 000				18,3	
19,8	76,1	70,1	16 100	13 300	11 400	9 900	78,8	69,7	14 700	12 600	10 900		19,8	
20,0	76,0	70,1	16 000	13 300	11 400	9 900	78,6	69,6	14 700	12 600	10 900		20,0	
21,3	74,9	69,7	15 800	13 100	11 200	9 900	77,5	69,3	14 500	12 400	10 800	9 500	21,3	
22,0	74,3	69,5	15 700	13 000	11 200	9 800	76,9	69,1	14 400	12 400	10 700	9 500	22,0	
22,9	73,5	69,2	15 500	12 900	11 100	9 700	76,1	68,8	14 300	12 300	10 700	9 400	22,9	
24,0	72,6	68,9	15 300	12 800	11 000	9 700	75,2	68,4	14 100	12 200	10 600	9 400	24,0	
24,4	72,2	68,7	15 200	12 700	11 000	9 600	74,8	68,3	14 100	12 200	10 600	9 300	24,4	
26,0	70,8	68,2	14 900	12 600	10 800	9 600	73,4	67,7	13 800	12 000	10 500	9 300	26,0	
28,0	69,1	67,4	14 600	12 400	10 700	9 400	71,6	66,9	13 600	11 800	10 400	9 200	28,0	
30,0	67,3	66,5	14 200	12 200	10 500	9 300	69,8	66,1	13 300	11 600	10 300	9 100	30,0	
32,0	65,5	65,6	13 900	12 000	10 400	9 200	68,0	65,1	13 100	11 500	10 200	9 100	32,0	
36,0	61,8	63,5	13 300	11 600	10 100	9 000	64,3	63,0	12 000	11 100	10 000	8 900	36,0	
40,0	58,0	61,1	12 700	11 200	9 800	8 800	60,4	60,5	11 100	10 800	9 700	8 800	40,0	
44,0	54,0	58,2	11 100	10 500	9 600	8 600	56,4	57,7	10 300	10 300	9 500	8 600	44,0	
48,0	49,7	54,9	9 400	9 000	8 600	8 100	52,1	54,4	9 600	9 300	8 900	8 400	48,0	
52,0	45,2	51,1	8 100	7 700	7 300	7 000	47,5	50,5	8 300	7 900	7 600	7 200	52,0	
56,0	40,3	46,6	6 900	6 600	6 300	6 000	42,5	45,9	7 100	6 800	6 500	6 200	56,0	
56,4	39,7	46,0	6 800	6 500	6 200	5 900	42,0	45,3	7 000	6 700	6 400	6 100	56,4	
60,0	34,7	41,1	5 800	5 600	5 300	5 100	36,9	40,3	6 000	5 800	5 500	5 300	60,0	
62,5	30,7	36,9	5 300	5 100	4 800	4 600	32,9	36,2	5 400	5 200	5 000	4 800	62,5	
64,0	28,2	34,2	4 900	4 700	4 500	4 300							64,0	
67,1	22,0	27,3	4 300	4 100	4 000	3 800							67,1	

MLC250 S-2

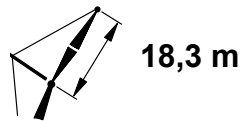
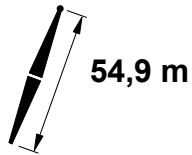

		5°						15°						
			0°	1°	2°	3°			0°	1°	2°	3°		
m	°	m	kg	kg	kg	kg	°	m	kg	kg	kg	kg	m	
15,2	80,4	74,3	16 900										15,2	
16,0	79,8	74,2	16 800										16,0	
16,8	79,2	74,0	16 600	13 700									16,8	
18,0	78,2	73,7	16 400	13 500									18,0	
18,3	77,9	73,7	16 400	13 500	11 500	9 900	80,5	73,2	15 000				18,3	
19,8	76,7	73,3	16 100	13 300	11 400	9 900	79,3	72,8	14 800	12 600			19,8	
20,0	76,6	73,3	16 100	13 300	11 400	9 900	79,1	72,8	14 700	12 500			20,0	
21,3	75,5	72,9	15 800	13 100	11 200	9 800	78,0	72,4	14 600	12 400	10 700	9 500	21,3	
22,0	75,0	72,7	15 700	13 000	11 200	9 800	77,5	72,2	14 500	12 400	10 700	9 400	22,0	
22,9	74,2	72,4	15 600	12 900	11 100	9 700	76,7	72,0	14 300	12 300	10 600	9 400	22,9	
24,0	73,3	72,1	15 400	12 800	11 000	9 700	75,8	71,6	14 200	12 200	10 600	9 300	24,0	
24,4	73,0	71,9	15 300	12 800	11 000	9 600	75,5	71,5	14 100	12 200	10 600	9 300	24,4	
26,0	71,7	71,4	15 000	12 600	10 900	9 500	74,1	70,9	13 900	12 100	10 500	9 300	26,0	
28,0	70,0	70,7	14 700	12 400	10 700	9 400	72,5	70,2	13 700	11 900	10 400	9 200	28,0	
30,0	68,3	69,9	14 400	12 200	10 600	9 300	70,8	69,4	13 400	11 700	10 300	9 100	30,0	
32,0	66,6	69,0	14 000	12 000	10 400	9 200	69,0	68,5	13 200	11 500	10 200	9 100	32,0	
36,0	63,1	67,0	13 500	11 600	10 100	9 000	65,5	66,5	12 400	11 200	10 000	8 900	36,0	
40,0	59,5	64,7	12 800	11 300	9 900	8 800	61,9	64,2	11 400	10 900	9 800	8 800	40,0	
44,0	55,7	62,0	10 900	10 300	9 700	8 600	58,1	61,5	10 600	10 600	9 600	8 700	44,0	
48,0	51,8	59,0	9 200	8 800	8 300	7 900	54,1	58,4	9 600	9 100	8 600	8 200	48,0	
52,0	47,6	55,4	7 900	7 500	7 100	6 700	49,8	54,8	8 200	7 700	7 400	7 000	52,0	
56,0	43,1	51,3	6 700	6 300	6 000	5 700	45,3	50,6	6 900	6 600	6 300	5 900	56,0	
59,4	38,8	47,1	5 800	5 500	5 200	5 000	41,0	46,4	6 000	5 700	5 400	5 200	59,4	
60,0	38,1	46,4	5 700	5 400	5 100	4 900	40,3	45,7	5 800	5 600	5 300	5 000	60,0	
64,0	32,5	40,5	4 800	4 500	4 300	4 100	34,6	39,6	4 900	4 700	4 500	4 200	64,0	
65,5	30,0	37,6	4 400	4 200	4 000	3 800	32,1	36,9	4 600	4 400	4 200	4 000	65,5	
68,0	25,8	33,0	4 000	3 800	3 600	3 400							68,0	
70,1	21,5	27,9	3 600	3 400	3 300	3 100							70,1	

MLC250 S-2

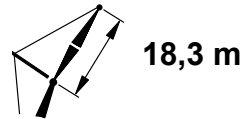
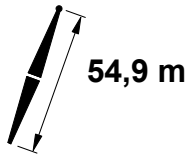
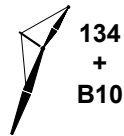

		25°					
		83 730 kg + 19 960 kg					
m	°	m	0° kg	1° kg	2° kg	3° kg	m
15,2							15,2
16,0							16,0
16,8							16,8
18,0							18,0
18,3							18,3
19,8							19,8
20,0							20,0
21,3	80,6	71,4	12 100				21,3
22,0	80,0	71,2	11 900				22,0
22,9	79,2	70,9	11 700	11 500			22,9
24,0	78,3	70,6	11 500	11 300			24,0
24,4	78,0	70,4	11 400	11 200	10 100	9 100	24,4
26,0	76,6	69,9	11 000	10 900	10 100	9 000	26,0
28,0	74,9	69,1	10 600	10 500	10 000	8 900	28,0
30,0	73,2	68,3	10 200	10 100	9 900	8 900	30,0
32,0	71,4	67,4	9 900	9 700	9 600	8 900	32,0
36,0	67,8	65,4	9 200	9 100	9 000	8 800	36,0
40,0	64,1	63,0	8 700	8 600	8 500	8 400	40,0
44,0	60,3	60,3	8 200	8 100	8 000	7 900	44,0
48,0	56,2	57,1	7 800	7 700	7 700	7 600	48,0
52,0	51,8	53,4	7 500	7 400	7 300	7 200	52,0
56,0	47,1	49,1	7 100	6 800	6 500	6 200	56,0
59,4	42,7	44,8	6 200	5 900	5 600	5 300	59,4
60,0							60,0
64,0							64,0
65,5							65,5
68,0							68,0
70,1							70,1

MLC250 S-2

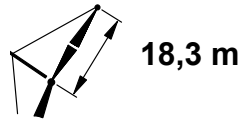
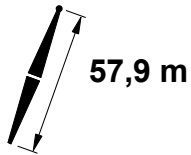

			5°				15°						
			0°	1°	2°	3°			0°	1°	2°	3°	
m	°	m	kg	kg	kg	kg	°	m	kg	kg	kg	kg	m
15,2	80,8	77,4	16 900										15,2
16,0	80,2	77,3	16 700										16,0
16,8	79,6	77,1	16 600	13 600									16,8
18,0	78,7	76,9	16 400	13 500									18,0
18,3	78,4	76,8	16 400	13 400	11 500		80,9	76,3	15 000				18,3
19,8	77,3	76,4	16 100	13 300	11 300	9 800	79,7	76,0	14 800	12 500			19,8
20,0	77,1	76,4	16 100	13 200	11 300	9 800	79,5	75,9	14 800	12 500			20,0
21,3	76,1	76,0	15 900	13 100	11 200	9 800	78,5	75,6	14 600	12 400	10 700		21,3
22,0	75,6	75,9	15 700	13 000	11 200	9 800	78,0	75,4	14 500	12 400	10 700		22,0
22,9	74,9	75,6	15 600	12 900	11 100	9 700	77,3	75,1	14 400	12 300	10 600	9 400	22,9
24,0	74,0	75,3	15 400	12 800	11 000	9 700	76,4	74,8	14 200	12 200	10 600	9 300	24,0
24,4	73,7	75,1	15 400	12 800	11 000	9 600	76,1	74,7	14 200	12 200	10 600	9 300	24,4
25,9	72,5	74,7	15 100	12 600	10 900	9 500	74,9	74,2	14 000	12 000	10 500	9 200	25,9
26,0	72,4	74,6	15 100	12 600	10 900	9 500	74,8	74,2	14 000	12 000	10 500	9 200	26,0
28,0	70,8	73,9	14 800	12 400	10 700	9 400	73,2	73,4	13 700	11 900	10 400	9 200	28,0
30,0	69,2	73,1	14 500	12 200	10 600	9 300	71,6	72,7	13 500	11 700	10 300	9 100	30,0
32,0	67,6	72,3	14 200	12 100	10 400	9 200	69,9	71,8	13 300	11 600	10 200	9 000	32,0
36,0	64,3	70,4	13 600	11 700	10 200	9 000	66,6	69,9	12 700	11 300	10 000	8 900	36,0
40,0	60,8	68,2	12 700	11 300	9 900	8 800	63,1	67,7	11 700	11 000	9 800	8 800	40,0
44,0	57,3	65,7	10 600	10 000	9 400	8 600	59,5	65,2	10 900	10 400	9 600	8 700	44,0
48,0	53,6	62,8	9 000	8 500	8 000	7 500	55,8	62,3	9 400	8 800	8 300	7 900	48,0
52,0	49,7	59,5	7 600	7 200	6 800	6 400	51,9	58,9	7 900	7 500	7 100	6 700	52,0
56,0	45,5	55,7	6 400	6 100	5 700	5 400	47,7	55,1	6 700	6 300	6 000	5 600	56,0
60,0	41,0	51,3	5 400	5 100	4 800	4 500	43,1	50,6	5 600	5 300	5 000	4 700	60,0
61,0	39,8	50,1	5 200	4 900	4 600	4 400	41,9	49,3	5 400	5 100	4 800	4 500	61,0
64,0	36,1	46,1	4 500	4 200	4 000	3 800	38,1	45,3	4 700	4 400	4 200	3 900	64,0
68,0	30,4	39,7	3 700	3 500	3 300	3 100	32,3	38,8	3 800	3 600	3 400	3 200	68,0
68,6	29,4	38,5	3 600	3 400	3 200	3 000	31,4	37,7	3 700	3 500	3 300	3 100	68,6
72,0	23,5	31,4	3 000	2 800	2 700	2 500							72,0
73,2	21,1	28,4	2 800	2 600	2 500	2 400							73,2

MLC250 S-2

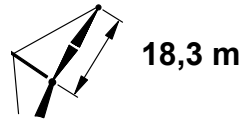
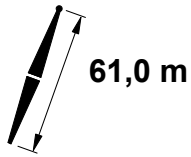

		5°						15°						
			0°	1°	2°	3°			0°	1°	2°	3°		
m	°	m	kg	kg	kg	kg	°	m	kg	kg	kg	kg	m	
16,8	80,0	80,2	16 600										16,8	
18,0	79,1	80,0	16 400										18,0	
18,3	78,9	79,9	16 300	13 400	11 400								18,3	
19,8	77,8	79,6	16 100	13 200	11 300	9 700	80,1	79,1	14 800				19,8	
20,0	77,6	79,5	16 000	13 200	11 300	9 700	80,0	79,1	14 800				20,0	
21,3	76,7	79,2	15 900	13 100	11 200	9 700	79,0	78,7	14 600	12 400	10 700		21,3	
22,0	76,1	79,0	15 700	13 000	11 100	9 700	78,5	78,6	14 500	12 300	10 600		22,0	
22,9	75,5	78,8	15 600	12 900	11 100	9 700	77,8	78,3	14 400	12 300	10 600	9 300	22,9	
24,0	74,6	78,5	15 500	12 800	11 000	9 600	76,9	78,0	14 300	12 200	10 500	9 300	24,0	
24,4	74,3	78,3	15 400	12 800	11 000	9 600	76,6	77,9	14 200	12 200	10 500	9 300	24,4	
25,9	73,2	77,9	15 200	12 600	10 800	9 500	75,5	77,4	14 000	12 100	10 400	9 200	25,9	
26,0	73,1	77,8	15 200	12 600	10 800	9 500	75,4	77,4	14 000	12 100	10 400	9 200	26,0	
28,0	71,6	77,2	14 900	12 400	10 700	9 400	73,9	76,7	13 800	11 900	10 400	9 200	28,0	
30,0	70,1	76,4	14 600	12 200	10 600	9 300	72,3	75,9	13 600	11 700	10 300	9 100	30,0	
32,0	68,5	75,6	14 200	12 100	10 400	9 200	70,8	75,1	13 400	11 600	10 200	9 000	32,0	
36,0	65,3	73,8	13 700	11 700	10 200	9 000	67,6	73,3	12 900	11 300	10 000	8 900	36,0	
40,0	62,1	71,7	12 400	11 300	9 900	8 800	64,3	71,2	12 000	11 000	9 800	8 800	40,0	
44,0	58,7	69,4	10 400	9 800	9 200	8 600	60,9	68,8	10 900	10 200	9 600	8 700	44,0	
48,0	55,2	66,7	8 800	8 200	7 700	7 300	57,4	66,1	9 200	8 600	8 100	7 600	48,0	
52,0	51,5	63,6	7 400	6 900	6 500	6 100	53,7	63,0	7 700	7 300	6 800	6 400	52,0	
56,0	47,7	60,0	6 200	5 800	5 500	5 100	49,8	59,4	6 500	6 100	5 800	5 400	56,0	
60,0	43,6	55,9	5 200	4 900	4 600	4 300	45,6	55,3	5 400	5 100	4 800	4 500	60,0	
64,0	39,1	51,2	4 300	4 000	3 800	3 500	41,0	50,5	4 500	4 200	4 000	3 700	64,0	
68,0	34,1	45,6	3 500	3 300	3 100	2 900	36,0	44,8	3 700	3 400	3 200	3 000	68,0	
71,6	28,8	39,3	2 900	2 700	2 500	2 300	30,7	38,4	3 000	2 800	2 600	2 400	71,6	
72,0	28,3	38,7	2 800	2 600	2 400	2 300							72,0	
74,7	23,4	32,5	2 400	2 200	2 100	1 900							74,7	
76,0	21,1	29,5	2 200	2 000	1 900								76,0	
76,2	20,6	28,9	2 100	2 000	1 800								76,2	

MLC250 S-2

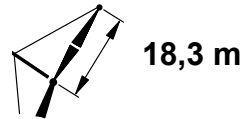
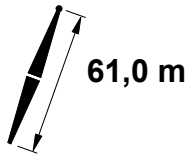
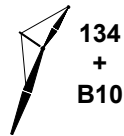

		25°					
		83 730 kg + 19 960 kg					
		0° 1° 2° 3°					
		kg					
m	°	m	kg	kg	kg	kg	m
16,8							16,8
18,0							18,0
18,3							18,3
19,8							19,8
20,0							20,0
21,3							21,3
22,0							22,0
22,9	80,2	77,3	12 000				22,9
24,0	79,3	76,9	11 700				24,0
24,4	79,0	76,8	11 600	11 400	10 100		24,4
25,9	77,8	76,3	11 300	11 200	10 100	8 900	25,9
26,0	77,7	76,3	11 300	11 200	10 100	8 900	26,0
28,0	76,2	75,6	10 900	10 800	10 000	8 900	28,0
30,0	74,6	74,8	10 500	10 400	9 900	8 900	30,0
32,0	73,0	74,0	10 200	10 100	9 800	8 800	32,0
36,0	69,8	72,2	9 600	9 400	9 300	8 800	36,0
40,0	66,4	70,1	9 000	8 900	8 800	8 600	40,0
44,0	63,0	67,6	8 600	8 500	8 300	8 200	44,0
48,0	59,4	64,8	8 100	8 000	7 900	7 800	48,0
52,0	55,6	61,6	7 800	7 600	7 100	6 700	52,0
56,0	51,6	58,0	6 800	6 400	6 000	5 700	56,0
60,0	47,3	53,7	5 600	5 300	5 000	4 700	60,0
64,0	42,6	48,8	4 700	4 400	4 100	3 900	64,0
68,0							68,0
71,6							71,6
72,0							72,0
74,7							74,7
76,0							76,0
76,2							76,2

MLC250 S-2

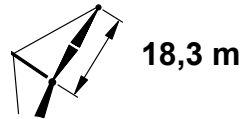
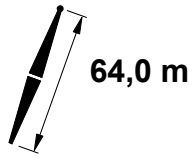

			5°				15°						
m	°	m	kg	kg	kg	kg	°	m	kg	kg	kg	kg	m
16,8	80,4	83,3	16 500										16,8
18,0	79,5	83,1	16 300										18,0
18,3	79,3	83,0	16 300	13 300									18,3
19,8	78,2	82,7	16 100	13 200	11 200		80,5	82,2	14 800				19,8
20,0	78,1	82,7	16 000	13 200	11 200		80,3	82,2	14 800				20,0
21,3	77,2	82,3	15 800	13 000	11 100	9 600	79,4	81,9	14 600	12 400			21,3
22,0	76,7	82,2	15 700	13 000	11 100	9 600	78,9	81,7	14 500	12 300			22,0
22,9	76,0	81,9	15 600	12 900	11 000	9 600	78,2	81,5	14 400	12 300	10 600		22,9
24,0	75,2	81,6	15 500	12 800	10 900	9 600	77,4	81,2	14 300	12 200	10 500		24,0
24,4	74,9	81,5	15 400	12 700	10 900	9 500	77,1	81,0	14 200	12 100	10 500	9 200	24,4
25,9	73,8	81,1	15 200	12 600	10 800	9 500	76,1	80,6	14 000	12 000	10 400	9 200	25,9
26,0	73,8	81,0	15 200	12 600	10 800	9 500	76,0	80,6	14 000	12 000	10 400	9 200	26,0
27,4	72,7	80,6	15 000	12 500	10 700	9 400	74,9	80,1	13 900	11 900	10 400	9 100	27,4
28,0	72,3	80,4	14 900	12 400	10 700	9 400	74,5	79,9	13 800	11 900	10 300	9 100	28,0
30,0	70,8	79,7	14 600	12 200	10 500	9 300	73,0	79,2	13 600	11 800	10 300	9 100	30,0
32,0	69,3	78,9	14 300	12 100	10 400	9 200	71,5	78,4	13 400	11 600	10 200	9 000	32,0
36,0	66,3	77,2	13 800	11 700	10 200	9 000	68,5	76,7	13 000	11 300	10 000	8 900	36,0
40,0	63,2	75,2	12 200	11 300	10 000	8 800	65,3	74,7	12 300	11 100	9 800	8 800	40,0
44,0	60,0	73,0	10 200	9 500	8 900	8 300	62,1	72,4	10 700	10 000	9 300	8 700	44,0
48,0	56,7	70,4	8 500	8 000	7 500	7 000	58,8	69,8	9 000	8 400	7 900	7 300	48,0
52,0	53,2	67,5	7 200	6 700	6 300	5 800	55,3	66,9	7 500	7 000	6 600	6 200	52,0
56,0	49,6	64,1	6 000	5 600	5 200	4 900	51,6	63,5	6 300	5 900	5 500	5 100	56,0
60,0	45,8	60,4	4 900	4 600	4 300	4 000	47,8	59,7	5 200	4 900	4 600	4 200	60,0
64,0	41,7	56,0	4 100	3 800	3 500	3 300	43,6	55,3	4 300	4 000	3 700	3 500	64,0
65,5	40,0	54,1	3 800	3 500	3 200	3 000	41,9	53,3	4 000	3 700	3 400	3 200	65,5
68,0	37,2	51,0	3 300	3 000	2 800	2 600	39,0	50,2	3 500	3 200	3 000	2 800	68,0
72,0	32,1	44,9	2 600	2 400	2 200	2 000	33,9	44,0	2 700	2 500	2 300	2 100	72,0
73,2	30,4	42,8	2 400	2 200	2 000	1 800	32,3	42,0	2 500	2 300	2 100	2 000	73,2
74,7	28,2	39,9	2 100	2 000									74,7
76,0	26,2	37,4	1 900										76,0
76,2	25,9	37,0	1 900										76,2

MLC250 S-2

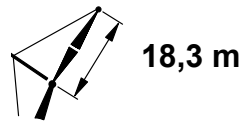
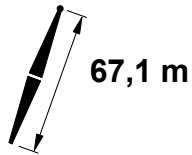

			5°				15°						
			0°	1°	2°	3°			0°	1°	2°	3°	
m	°	m	kg	kg	kg	kg	°	m	kg	kg	kg	kg	m
16,8	80,8	86,4	16 400										16,8
18,0	79,9	86,2	16 300										18,0
18,3	79,7	86,1	16 200	13 300									18,3
19,8	78,7	85,8	16 000	13 100	11 200		80,8	85,4	14 800				19,8
20,0	78,5	85,8	16 000	13 100	11 200		80,7	85,3	14 800				20,0
21,3	77,6	85,5	15 800	13 000	11 100	9 500	79,8	85,0	14 600	12 300			21,3
22,0	77,2	85,3	15 700	12 900	11 000	9 500	79,3	84,8	14 500	12 300			22,0
22,9	76,5	85,1	15 600	12 800	11 000	9 500	78,7	84,6	14 400	12 200	10 500		22,9
24,0	75,8	84,8	15 500	12 700	10 900	9 500	77,9	84,3	14 300	12 100	10 500		24,0
24,4	75,5	84,7	15 400	12 700	10 900	9 500	77,6	84,2	14 200	12 100	10 400	9 200	24,4
25,9	74,4	84,2	15 200	12 500	10 800	9 400	76,6	83,8	14 100	12 000	10 400	9 200	25,9
26,0	74,4	84,2	15 200	12 500	10 800	9 400	76,5	83,7	14 100	12 000	10 400	9 200	26,0
27,4	73,4	83,8	15 000	12 400	10 700	9 400	75,5	83,3	13 900	11 900	10 300	9 100	27,4
28,0	73,0	83,6	14 900	12 400	10 600	9 300	75,1	83,1	13 900	11 900	10 300	9 100	28,0
30,0	71,5	82,9	14 700	12 200	10 500	9 200	73,7	82,4	13 700	11 800	10 200	9 000	30,0
32,0	70,1	82,2	14 400	12 000	10 400	9 100	72,2	81,7	13 400	11 600	10 100	9 000	32,0
36,0	67,2	80,5	13 900	11 800	10 200	9 000	69,3	80,0	13 100	11 400	10 000	8 900	36,0
40,0	64,2	78,6	12 000	11 200	9 900	8 800	66,3	78,1	12 500	11 100	9 800	8 700	40,0
44,0	61,2	76,5	10 000	9 300	8 600	8 000	63,2	76,0	10 500	9 800	9 100	8 400	44,0
48,0	58,0	74,0	8 300	7 800	7 200	6 700	60,1	73,5	8 800	8 200	7 600	7 100	48,0
52,0	54,8	71,3	6 900	6 500	6 000	5 600	56,8	70,7	7 300	6 800	6 400	5 900	52,0
56,0	51,4	68,2	5 800	5 400	5 000	4 600	53,3	67,6	6 100	5 700	5 300	4 900	56,0
60,0	47,8	64,6	4 700	4 400	4 100	3 800	49,7	64,0	5 000	4 700	4 300	4 000	60,0
64,0	44,0	60,6	3 900	3 600	3 300	3 000	45,9	59,9	4 100	3 800	3 500	3 200	64,0
68,0	39,9	56,0	3 100	2 800	2 600	2 300	41,7	55,2	3 300	3 000	2 800	2 500	68,0
68,6	39,2	55,2	3 000	2 700	2 500	2 300	41,0	54,4	3 200	2 900	2 700	2 400	68,6
71,6	35,8	51,1	2 400	2 200	2 000	1 800	37,5	50,3	2 600	2 400	2 200	2 000	71,6
72,0	35,3	50,6	2 400	2 200	2 000		37,1	49,8	2 500	2 300	2 100		72,0
73,2	33,9	48,8	2 200	2 000	1 800		35,6	47,9	2 300	2 100	1 900		73,2
74,7	32,0	46,4	1 900				33,6	45,3	2 100	1 900			74,7
76,0							31,9	43,2	1 900				76,0
76,2							31,6	42,8	1 800				76,2

MLC250 S-2

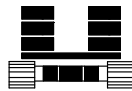

83 730 kg
+
19 960 kg

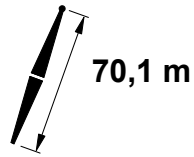

70,1 m

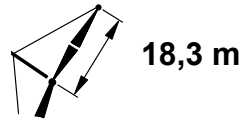

18,3 m

		5°						15°						
			0°	1°	2°	3°			0°	1°	2°	3°		
m	°	m	kg	kg	kg	kg	°	m	kg	kg	kg	kg	m	
18,3	80,1	89,3	16 200	13 100									18,3	
19,8	79,1	88,9	15 900	13 000									19,8	
20,0	78,9	88,9	15 900	13 000									20,0	
21,3	78,1	88,6	15 700	12 900	11 000		80,1	88,1	14 600				21,3	
22,0	77,6	88,5	15 700	12 900	11 000		79,7	88,0	14 500				22,0	
22,9	77,0	88,2	15 500	12 800	10 900	9 300	79,1	87,7	14 400	12 100			22,9	
24,0	76,3	88,0	15 400	12 700	10 800	9 300	78,3	87,5	14 300	12 100			24,0	
24,4	76,0	87,8	15 400	12 700	10 800	9 300	78,1	87,4	14 200	12 100	10 400		24,4	
25,9	75,0	87,4	15 200	12 500	10 700	9 300	77,0	86,9	14 100	12 000	10 300	9 100	25,9	
26,0	74,9	87,4	15 200	12 500	10 700	9 300	77,0	86,9	14 100	12 000	10 300	9 100	26,0	
27,4	74,0	87,0	15 000	12 400	10 600	9 300	76,0	86,5	13 900	11 900	10 300	9 000	27,4	
28,0	73,6	86,8	14 900	12 300	10 600	9 300	75,6	86,3	13 900	11 800	10 200	9 000	28,0	
29,0	72,9	86,5	14 800	12 300	10 500	9 200	74,9	86,0	13 800	11 800	10 200	9 000	29,0	
30,0	72,2	86,1	14 700	12 200	10 500	9 200	74,3	85,7	13 700	11 700	10 200	9 000	30,0	
32,0	70,8	85,4	14 400	12 000	10 300	9 100	72,9	84,9	13 500	11 600	10 100	8 900	32,0	
36,0	68,0	83,9	13 900	11 700	10 100	8 900	70,1	83,4	13 100	11 400	10 000	8 800	36,0	
40,0	65,2	82,0	11 800	10 900	9 800	8 800	67,2	81,5	12 400	11 100	9 800	8 700	40,0	
44,0	62,3	80,0	9 700	9 000	8 300	7 700	64,3	79,5	10 300	9 500	8 800	8 200	44,0	
48,0	59,3	77,7	8 100	7 500	6 900	6 400	61,2	77,1	8 500	7 900	7 300	6 800	48,0	
52,0	56,2	75,0	6 700	6 200	5 700	5 200	58,1	74,5	7 100	6 600	6 100	5 600	52,0	
56,0	52,9	72,1	5 500	5 100	4 700	4 300	54,9	71,5	5 800	5 400	5 000	4 600	56,0	
60,0	49,6	68,7	4 500	4 100	3 800	3 400	51,5	68,1	4 800	4 400	4 100	3 700	60,0	
64,0	46,0	65,0	3 600	3 300	3 000	2 700	47,9	64,3	3 800	3 500	3 200	2 900	64,0	
68,0	42,2	60,7	2 800	2 500	2 300	2 000	44,0	60,0	3 000	2 800	2 500	2 200	68,0	
68,6	41,6	60,0	2 700	2 400	2 200	1 900	43,4	59,3	2 900	2 700	2 400	2 100	68,6	
70,1	40,1	58,1	2 400	2 200	1 900		41,8	57,4	2 600	2 400	2 100	1 900	70,1	
71,6	38,5	56,3	2 200	1 900			40,2	55,5	2 400	2 100	1 900		71,6	
72,0	38,1	55,8	2 100				39,9	55,0	2 300	2 100			72,0	
73,2	36,9	54,2	1 900				38,5	53,4	2 100	1 900			73,2	
74,7							36,8	51,2	1 800				74,7	

MLC250 S-2

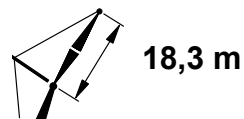
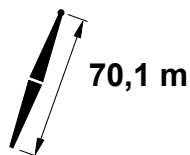

		25°					
		83 730 kg + 19 960 kg					
m	°	m	0° kg	1° kg	2° kg	3° kg	m
18,3							18,3
19,8							19,8
20,0							20,0
21,3							21,3
22,0							22,0
22,9							22,9
24,0							24,0
24,4	80,2	86,3	12 000				24,4
25,9	79,1	85,9	11 700	11 300			25,9
26,0	79,1	85,8	11 700	11 300			26,0
27,4	78,1	85,4	11 400	11 200	9 900		27,4
28,0	77,7	85,2	11 300	11 100	9 900		28,0
29,0	77,0	84,9	11 100	11 000	9 900	8 200	29,0
30,0	76,3	84,5	10 900	10 800	9 800	8 200	30,0
32,0	74,9	83,8	10 600	10 500	9 800	8 200	32,0
36,0	72,0	82,2	10 000	9 900	9 600	8 200	36,0
40,0	69,1	80,4	9 500	9 300	9 200	8 200	40,0
44,0	66,2	78,3	9 000	8 900	8 700	8 200	44,0
48,0	63,1	75,9	8 600	8 300	7 800	7 200	48,0
52,0	59,9	73,2	7 500	6 900	6 400	6 000	52,0
56,0	56,6	70,1	6 200	5 700	5 300	4 900	56,0
60,0	53,1	66,7	5 100	4 700	4 300	4 000	60,0
64,0	49,4	62,8	4 100	3 800	3 400	3 100	64,0
68,0	45,5	58,4	3 200	2 900	2 700	2 400	68,0
68,6	44,9	57,7	3 100	2 800	2 600	2 300	68,6
70,1	43,3	55,8	2 800	2 500	2 300	2 100	70,1
71,6							71,6
72,0							72,0
73,2							73,2
74,7							74,7

MLC250 S-2



83 730 kg
+
19 960 kg

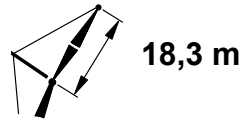
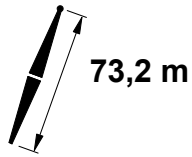

		5°						15°						
			0°	1°	2°	3°			0°	1°	2°	3°		
m	°	m	kg	kg	kg	kg	°	m	kg	kg	kg	kg	m	
18,3	80,4	92,4	16 100										18,3	
19,8	79,4	92,1	15 900	13 000									19,8	
20,0	79,3	92,0	15 800	12 900									20,0	
21,3	78,5	91,7	15 700	12 800	10 900		80,5	91,3	14 500				21,3	
22,0	78,0	91,6	15 600	12 800	10 900		80,0	91,1	14 500				22,0	
22,9	77,4	91,4	15 500	12 700	10 800	8 900	79,4	90,9	14 400	12 100			22,9	
24,0	76,7	91,1	15 400	12 600	10 800	8 900	78,7	90,6	14 200	12 000			24,0	
24,4	76,5	91,0	15 300	12 600	10 700	8 900	78,5	90,5	14 200	12 000	10 300		24,4	
25,9	75,5	90,6	15 100	12 400	10 600	8 800	77,5	90,1	14 100	11 900	10 300	8 500	25,9	
26,0	75,4	90,6	15 100	12 400	10 600	8 800	77,4	90,1	14 100	11 900	10 300	8 500	26,0	
27,4	74,5	90,2	14 900	12 300	10 600	8 800	76,5	89,7	13 900	11 800	10 200	8 400	27,4	
28,0	74,1	90,0	14 900	12 300	10 500	8 800	76,1	89,5	13 800	11 800	10 200	8 400	28,0	
29,0	73,5	89,7	14 800	12 200	10 500	8 800	75,5	89,2	13 700	11 700	10 200	8 400	29,0	
30,0	72,8	89,4	14 600	12 100	10 400	8 800	74,8	88,9	13 700	11 700	10 100	8 400	30,0	
32,0	71,5	88,7	14 400	12 000	10 300	8 700	73,5	88,2	13 500	11 600	10 000	8 400	32,0	
36,0	68,8	87,2	13 800	11 700	10 100	8 700	70,8	86,6	13 100	11 400	9 900	8 400	36,0	
40,0	66,1	85,4	11 500	10 600	9 700	8 600	68,0	84,9	12 200	11 000	9 800	8 400	40,0	
44,0	63,3	83,4	9 500	8 800	8 100	7 400	65,2	82,9	10 100	9 300	8 600	7 900	44,0	
48,0	60,4	81,2	7 900	7 200	6 700	6 100	62,3	80,7	8 300	7 700	7 100	6 500	48,0	
52,0	57,5	78,7	6 500	5 900	5 400	5 000	59,3	78,1	6 900	6 400	5 800	5 400	52,0	
56,0	54,4	75,9	5 300	4 800	4 400	4 000	56,3	75,3	5 700	5 200	4 800	4 400	56,0	
60,0	51,2	72,8	4 300	3 900	3 500	3 200	53,0	72,1	4 600	4 200	3 800	3 500	60,0	
64,0	47,9	69,2	3 400	3 000	2 700	2 400	49,7	68,6	3 700	3 300	3 000	2 700	64,0	
67,1	45,2	66,2	2 800	2 500	2 200	1 900	46,9	65,5	3 000	2 700	2 400	2 200	67,1	
68,0	44,3	65,2	2 600	2 300	2 000		46,1	64,6	2 800	2 500	2 300	2 000	68,0	
68,6	43,8	64,6	2 500	2 200	1 900		45,5	63,9	2 700	2 400	2 200	1 900	68,6	
70,1	42,3	62,9	2 200	1 900			44,1	62,1	2 400	2 200	1 900		70,1	
71,6	40,9	61,2	1 900				42,6	60,4	2 200	1 900			71,6	
72,0							42,2	60,0	2 100				72,0	
73,2							41,1	58,5	1 900				73,2	

MLC250 S-2

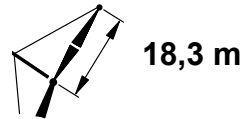
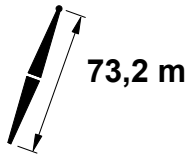
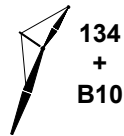

				25°					
				83 730 kg + 19 960 kg					
				0°	1°	2°	3°		
				kg	kg	kg	kg		
				kg	kg	kg	kg		
				kg	kg	kg	kg		
				kg	kg	kg	kg		
				kg	kg	kg	kg		
				kg	kg	kg	kg		
				kg	kg	kg	kg		
				kg	kg	kg	kg		
				kg	kg	kg	kg		
				kg	kg	kg	kg		
				kg	kg	kg	kg		
				kg	kg	kg	kg		
				kg	kg	kg	kg		
				kg	kg	kg	kg		
				kg	kg	kg	kg		
				kg	kg	kg	kg		
				kg	kg	kg	kg		
				kg	kg	kg	kg		
				kg	kg	kg	kg		
				kg	kg	kg	kg		
				kg	kg	kg	kg		
				kg	kg	kg	kg		
				kg	kg	kg	kg		
				kg	kg	kg	kg		
				kg	kg	kg	kg		
				kg	kg	kg	kg		
				kg	kg	kg	kg		
				kg	kg	kg	kg		
				kg	kg	kg	kg		
				kg	kg	kg	kg		
				kg	kg	kg	kg		
				kg	kg	kg	kg		
				kg	kg	kg	kg		
				kg	kg	kg	kg		
				kg	kg	kg	kg		
				kg	kg	kg	kg		
				kg	kg	kg	kg		
				kg	kg	kg	kg		
				kg	kg	kg	kg		
				kg	kg	kg	kg		
				kg	kg	kg	kg		
				kg	kg	kg	kg		
				kg	kg	kg	kg		
				kg	kg	kg	kg		
				kg	kg	kg	kg		
				kg	kg	kg	kg		
				kg	kg	kg	kg		
				kg	kg	kg	kg		
				kg	kg	kg	kg		
				kg	kg	kg	kg		
				kg	kg	kg	kg		
				kg	kg	kg	kg		
				kg	kg	kg	kg		
				kg	kg	kg	kg		
				kg	kg	kg	kg		
				kg	kg	kg	kg		
				kg	kg	kg	kg		
				kg	kg	kg	kg		
				kg	kg	kg	kg		
				kg	kg	kg	kg		
				kg	kg	kg	kg		
				kg	kg	kg	kg		
				kg	kg	kg	kg		
				kg	kg	kg	kg		
				kg	kg	kg	kg		
				kg	kg	kg	kg		
				kg	kg	kg	kg		
				kg	kg	kg	kg		
				kg	kg	kg	kg		
				kg	kg	kg	kg		
				kg	kg	kg	kg		
				kg	kg	kg	kg		
				kg	kg	kg	kg		
				kg	kg	kg	kg		
				kg	kg	kg	kg		
				kg	kg	kg	kg		
				kg	kg	kg	kg		
				kg	kg	kg	kg		
				kg	kg	kg	kg		
				kg	kg	kg	kg		
				kg	kg	kg	kg		
				kg	kg	kg	kg		
				kg	kg	kg	kg		
				kg	kg	kg	kg		
				kg	kg	kg	kg		
				kg	kg	kg	kg		
				kg	kg	kg	kg		
				kg	kg	kg	kg		
							</		

MLC250 S-2

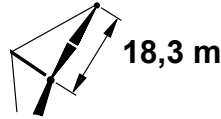
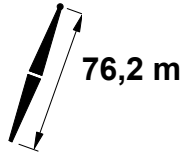
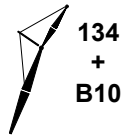

	5°			15°			
	m	°	m	kg	°	m	
18,3	80,7	95,5	15 900				18,3
20,0	79,7	95,1	15 700				20,0
21,3	78,9	94,9	15 600	80,8	94,4	14 500	21,3
22,0	78,4	94,7	15 500	80,4	94,2	14 400	22,0
24,0	77,2	94,2	15 300	79,1	93,8	14 200	24,0
24,4	76,9	94,1	15 200	78,9	93,6	14 200	24,4
26,0	75,9	93,7	15 000	77,9	93,2	14 000	26,0
28,0	74,7	93,2	14 800	76,6	92,7	13 800	28,0
30,0	73,4	92,6	14 600	75,3	92,1	13 600	30,0
32,0	72,1	91,9	14 400	74,0	91,4	13 500	32,0
36,0	69,5	90,4	13 800	71,4	89,9	13 100	36,0
40,0	66,9	88,8	11 600	68,8	88,2	12 200	40,0
44,0	64,2	86,9	9 600	66,1	86,3	10 100	44,0
48,0	61,5	84,7	7 900	63,3	84,2	8 400	48,0
52,0	58,6	82,3	6 500	60,5	81,8	6 900	52,0
56,0	55,7	79,7	5 300	57,5	79,1	5 700	56,0
60,0	52,7	76,7	4 300	54,5	76,1	4 600	60,0
64,0	49,5	73,3	3 400	51,3	72,7	3 700	64,0
68,0	46,2	69,6	2 600	47,9	68,9	2 900	68,0
71,6	43,0	65,8	2 000	44,7	65,1	2 200	71,6
72,0				44,4	64,7	2 100	72,0
73,2				43,3	63,3	2 000	73,2
74,7							74,7

MLC250 S-2

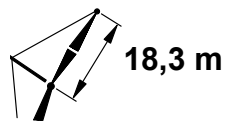
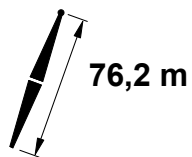

25°				
0°				
m	°	m	kg	m
18,3				18,3
20,0				20,0
21,3				21,3
22,0				22,0
24,0				24,0
24,4	80,8	92,6	12 200	24,4
26,0	79,8	92,1	11 900	26,0
28,0	78,5	91,6	11 500	28,0
30,0	77,2	90,9	11 200	30,0
32,0	75,9	90,3	10 800	32,0
36,0	73,3	88,8	10 200	36,0
40,0	70,6	87,1	9 700	40,0
44,0	67,9	85,1	9 300	44,0
48,0	65,1	83,0	8 700	48,0
52,0	62,2	80,5	7 300	52,0
56,0	59,2	77,8	6 100	56,0
60,0	56,1	74,7	4 900	60,0
64,0	52,8	71,3	4 000	64,0
68,0	49,4	67,4	3 100	68,0
71,6	46,1	63,5	2 400	71,6
72,0	45,8	63,1	2 300	72,0
73,2	44,6	61,7	2 100	73,2
74,7	43,2	59,8	1 900	74,7

MLC250 S-2

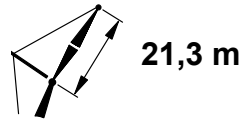
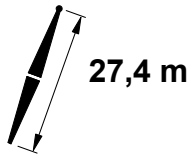

			5°				15°						
			0°	1°	2°	3°			0°	1°	2°	3°	
m	°	m	kg	kg	kg	kg	°	m	kg	kg	kg	kg	m
12,2	79,3	50,1	13 300	11 300									12,2
13,7	77,5	49,8	13 300	11 200									13,7
14,0	77,1	49,7	13 300	11 200	9 000	7 500							14,0
15,2	75,7	49,4	13 000	11 000	9 000	7 500	80,1	49,0	12 000				15,2
16,0	74,7	49,2	12 800	10 900	9 000	7 500	79,1	48,8	11 900				16,0
16,8	73,7	48,9	12 600	10 700	9 000	7 500	78,1	48,5	11 700	10 100	8 900		16,8
18,0	72,2	48,5	12 300	10 500	8 900	7 400	76,6	48,1	11 500	9 900	8 800		18,0
18,3	71,8	48,4	12 200	10 500	8 900	7 400	76,3	48,0	11 400	9 900	8 700	7 500	18,3
19,8	70,0	47,8	11 900	10 200	8 900	7 400	74,4	47,4	11 100	9 700	8 600	7 500	19,8
20,0	69,7	47,7	11 900	10 200	8 900	7 400	74,1	47,4	11 100	9 600	8 500	7 500	20,0
21,3	68,0	47,2	11 600	10 000	8 800	7 400	72,4	46,8	10 900	9 500	8 400	7 500	21,3
22,0	67,2	46,9	11 400	9 900	8 700	7 400	71,5	46,5	10 800	9 400	8 300	7 500	22,0
24,0	64,5	45,9	11 000	9 500	8 400	7 300	68,9	45,5	10 400	9 100	8 100	7 300	24,0
26,0	61,9	44,8	10 700	9 300	8 200	7 300	66,2	44,4	10 100	8 900	7 900	7 200	26,0
28,0	59,1	43,6	10 300	9 000	8 000	7 200	63,4	43,2	9 800	8 700	7 800	7 000	28,0
30,0	56,3	42,3	9 900	8 800	7 800	7 100	60,6	41,9	9 500	8 500	7 600	6 900	30,0
32,0	53,4	40,8	9 600	8 500	7 600	6 900	57,6	40,4	9 200	8 300	7 500	6 800	32,0
36,0	47,1	37,3	9 000	8 100	7 300	6 600	51,3	36,8	8 400	7 900	7 200	6 600	36,0
40,0	40,1	32,8	8 500	7 700	6 900	6 300	44,1	32,3	7 500	7 500	6 900	6 400	40,0
42,7	34,5	28,9	8 100	7 400	6 800	6 200	38,4	28,2	7 100	7 100	6 800	6 300	42,7
44,0	31,7	26,9	7 900	7 300	6 700	6 100	35,6	26,3	6 900	6 900	6 800	6 200	44,0
45,7	27,0	23,4	7 600	7 200	6 600	6 100	31,1	22,9	6 700	6 600	6 600	6 200	45,7
47,2	22,9	20,2	7 300	7 100	6 500	6 000							47,2

MLC250 S-2

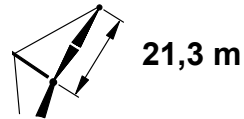
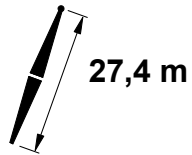

		25°					
		83 730 kg + 19 960 kg					
		0°					
		1°					
		2°					
		3°					
		kg					
m	°	m	kg	kg	kg	kg	m
12,2							12,2
13,7							13,7
14,0							14,0
15,2							15,2
16,0							16,0
16,8							16,8
18,0							18,0
18,3	80,9	47,2	10 500				18,3
19,8	78,9	46,6	10 300	9 100	8 100		19,8
20,0	78,7	46,5	10 300	9 100	8 100		20,0
21,3	77,0	45,9	9 900	8 900	8 000	7 200	21,3
22,0	76,0	45,6	9 700	8 900	7 900	7 200	22,0
24,0	73,3	44,6	9 100	8 700	7 800	7 100	24,0
26,0	70,6	43,5	8 500	8 400	7 700	6 900	26,0
28,0	67,8	42,2	8 100	7 900	7 500	6 800	28,0
30,0	64,8	40,9	7 600	7 500	7 400	6 700	30,0
32,0	61,8	39,3	7 300	7 200	7 100	6 700	32,0
36,0	55,2	35,6	6 600	6 600	6 500	6 400	36,0
40,0	47,8	30,9	6 100	6 100	6 000	6 000	40,0
42,7	42,0	26,9	5 900	5 800	5 800	5 800	42,7
44,0							44,0
45,7							45,7
47,2							47,2

MLC250 S-2

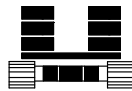

83 730 kg
+
19 960 kg

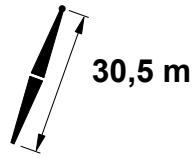

30,5 m



21,3 m

		5°						15°							
m	°	m	kg	kg	kg	kg	°	m	kg	kg	kg	kg	m		
12,2	79,9	53,3	13 300	11 300									12,2		
13,7	78,2	52,9	13 300	11 200									13,7		
14,0	77,9	52,9	13 300	11 200	9 000								14,0		
15,2	76,5	52,5	13 100	11 100	9 000	7 500	80,7	52,2	12 100				15,2		
16,0	75,6	52,3	13 000	11 000	9 000	7 500	79,8	52,0	12 000				16,0		
16,8	74,7	52,1	12 800	10 900	8 900	7 400	78,9	51,7	11 800	10 200	8 900		16,8		
18,0	73,3	51,7	12 500	10 600	8 900	7 400	77,5	51,3	11 600	10 000	8 800		18,0		
18,3	72,9	51,6	12 400	10 600	8 900	7 400	77,1	51,2	11 600	9 900	8 800	7 500	18,3		
19,8	71,2	51,1	12 100	10 300	8 900	7 400	75,3	50,7	11 300	9 800	8 600	7 500	19,8		
20,0	71,0	51,0	12 100	10 300	8 900	7 400	75,1	50,6	11 200	9 700	8 600	7 500	20,0		
21,3	69,4	50,5	11 800	10 100	8 800	7 400	73,6	50,1	11 000	9 600	8 500	7 500	21,3		
22,0	68,6	50,2	11 600	10 000	8 800	7 400	72,7	49,8	10 900	9 500	8 400	7 500	22,0		
24,0	66,2	49,3	11 300	9 700	8 600	7 300	70,3	48,9	10 600	9 200	8 200	7 400	24,0		
26,0	63,7	48,3	10 900	9 400	8 400	7 300	67,8	47,9	10 300	9 000	8 100	7 300	26,0		
28,0	61,1	47,2	10 500	9 200	8 100	7 300	65,2	46,8	10 000	8 800	7 900	7 100	28,0		
30,0	58,6	46,0	10 200	8 900	7 900	7 200	62,6	45,5	9 700	8 600	7 700	7 000	30,0		
32,0	55,9	44,6	9 900	8 700	7 800	7 000	59,9	44,2	9 400	8 400	7 600	6 900	32,0		
36,0	50,2	41,4	9 300	8 200	7 400	6 700	54,2	40,9	8 800	8 000	7 300	6 600	36,0		
40,0	44,0	37,5	8 800	7 900	7 100	6 500	47,9	37,0	7 900	7 700	7 100	6 500	40,0		
44,0	37,0	32,6	8 300	7 500	6 800	6 200	40,7	31,9	7 300	7 200	6 800	6 300	44,0		
44,2	36,6	32,2	8 300	7 500	6 800	6 200	40,3	31,6	7 200	7 200	6 800	6 300	44,2		
48,0	28,4	26,0	7 700	7 200	6 600	6 100	32,0	25,2	6 700	6 700	6 600	6 200	48,0		
48,8	26,3	24,2	7 500	7 200	6 600	6 000	29,9	23,5	6 600	6 600	6 600	6 200	48,8		
50,3	22,2	20,8	7 300	7 100	6 500	6 000							50,3		

MLC250 S-2

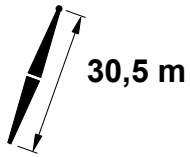
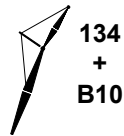

		25°					
		83 730 kg + 19 960 kg					
		0° 1° 2° 3°					
		kg					
m	°	m	kg	kg	kg	kg	m
12,2							12,2
13,7							13,7
14,0							14,0
15,2							15,2
16,0							16,0
16,8							16,8
18,0							18,0
18,3							18,3
19,8	79,6	49,8	10 400	9 100			19,8
20,0	79,4	49,7	10 300	9 100			20,0
21,3	77,8	49,2	10 100	9 000	8 000	7 200	21,3
22,0	77,0	48,9	9 900	8 900	8 000	7 200	22,0
24,0	74,5	48,0	9 300	8 700	7 800	7 100	24,0
26,0	71,9	46,9	8 800	8 600	7 700	7 000	26,0
28,0	69,3	45,8	8 300	8 200	7 600	6 900	28,0
30,0	66,6	44,5	7 900	7 800	7 500	6 800	30,0
32,0	63,8	43,1	7 500	7 400	7 300	6 700	32,0
36,0	58,0	39,8	6 900	6 800	6 700	6 600	36,0
40,0	51,5	35,7	6 400	6 300	6 200	6 200	40,0
44,0	44,0	30,4	5 900	5 900	5 900	5 800	44,0
44,2	43,6	30,1	5 900	5 900	5 800	5 800	44,2
48,0							48,0
48,8							48,8
50,3							50,3

MLC250 S-2

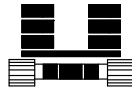
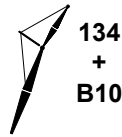

83 730 kg
+
19 960 kg

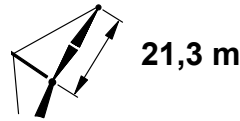
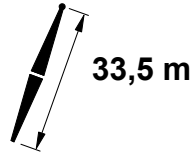

		5°					15°						
			0°	1°	2°	3°			0°	1°	2°	3°	
m	°	m	kg	kg	kg	kg	°	m	kg	kg	kg	kg	m
12,2	80,5	56,4	13 300	11 200	9 000								12,2
13,7	78,9	56,0	13 300	11 200	9 000								13,7
14,0	78,6	56,0	13 300	11 200	9 000								14,0
15,2	77,3	55,7	13 200	11 100	8 900	7 400							15,2
16,0	76,4	55,5	13 100	11 000	8 900	7 400							16,0
16,8	75,6	55,3	12 900	10 900	8 900	7 400	79,6	54,9	11 900	10 200			16,8
18,0	74,3	54,9	12 700	10 700	8 900	7 400	78,2	54,5	11 700	10 000			18,0
18,3	73,9	54,8	12 600	10 700	8 900	7 400	77,9	54,4	11 600	10 000	8 800	7 500	18,3
19,8	72,3	54,3	12 300	10 500	8 800	7 400	76,2	53,9	11 400	9 800	8 700	7 500	19,8
20,0	72,1	54,3	12 200	10 400	8 800	7 400	76,0	53,9	11 300	9 800	8 700	7 500	20,0
21,3	70,6	53,8	12 000	10 200	8 800	7 400	74,5	53,4	11 100	9 700	8 500	7 500	21,3
22,0	69,8	53,5	11 800	10 100	8 800	7 300	73,7	53,1	11 000	9 600	8 500	7 500	22,0
22,9	68,8	53,1	11 700	10 000	8 700	7 300	72,7	52,7	10 900	9 500	8 400	7 500	22,9
24,0	67,6	52,7	11 500	9 900	8 700	7 300	71,5	52,3	10 700	9 400	8 300	7 400	24,0
26,0	65,3	51,7	11 100	9 600	8 500	7 300	69,1	51,3	10 400	9 100	8 100	7 300	26,0
28,0	62,9	50,7	10 800	9 300	8 300	7 300	66,8	50,3	10 100	8 900	8 000	7 200	28,0
30,0	60,5	49,6	10 400	9 100	8 100	7 200	64,3	49,1	9 800	8 700	7 800	7 100	30,0
32,0	58,0	48,3	10 100	8 900	7 900	7 100	61,8	47,9	9 600	8 500	7 700	6 900	32,0
36,0	52,9	45,4	9 500	8 400	7 600	6 800	56,6	44,9	9 100	8 200	7 400	6 700	36,0
40,0	47,3	41,9	9 000	8 000	7 200	6 600	51,0	41,4	8 300	7 900	7 100	6 500	40,0
44,0	41,2	37,6	8 600	7 700	7 000	6 400	44,7	37,0	7 600	7 500	6 900	6 400	44,0
47,2	35,4	33,1	8 200	7 400	6 800	6 200	38,9	32,5	7 100	7 100	6 800	6 300	47,2
48,0	34,1	32,1	8 100	7 400	6 700	6 200	37,5	31,4	7 000	7 000	6 800	6 300	48,0
50,3	29,0	27,8	7 700	7 200	6 600	6 100	32,6	27,4	6 800	6 700	6 700	6 200	50,3
52,0	25,2	24,6	7 500	7 100	6 500	6 000							52,0
53,3	21,5	21,3	7 200	7 100	6 500	6 000							53,3

MLC250 S-2

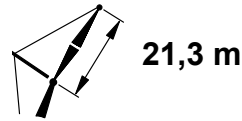
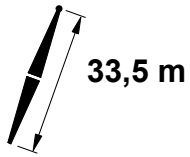
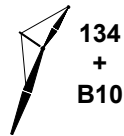

				25°					
				83 730 kg + 19 960 kg					
	m	°	m	0° kg	1° kg	2° kg	3° kg	m	
12,2								12,2	
13,7								13,7	
14,0								14,0	
15,2								15,2	
16,0								16,0	
16,8								16,8	
18,0								18,0	
18,3								18,3	
19,8	80,3		53,0	10 400				19,8	
20,0	80,0		52,9	10 400				20,0	
21,3	78,5		52,4	10 200	9 000	8 000		21,3	
22,0	77,7		52,1	10 100	9 000	8 000		22,0	
22,9	76,7		51,8	9 800	8 900	7 900	7 200	22,9	
24,0	75,4		51,3	9 500	8 800	7 900	7 100	24,0	
26,0	73,0		50,3	9 000	8 600	7 800	7 000	26,0	
28,0	70,6		49,3	8 600	8 400	7 600	6 900	28,0	
30,0	68,1		48,1	8 100	8 000	7 500	6 900	30,0	
32,0	65,6		46,8	7 700	7 600	7 400	6 800	32,0	
36,0	60,2		43,8	7 100	7 000	6 900	6 600	36,0	
40,0	54,4		40,1	6 600	6 500	6 400	6 400	40,0	
44,0	48,0		35,5	6 100	6 100	6 000	6 000	44,0	
47,2	41,9		30,9	5 900	5 800	5 800	5 700	47,2	
48,0								48,0	
50,3								50,3	
52,0								52,0	
53,3								53,3	

MLC250 S-2

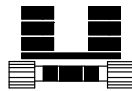

83 730 kg
+
19 960 kg

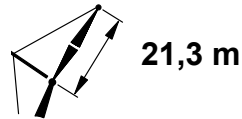
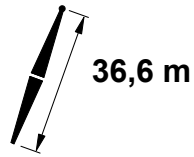

		5°						15°							
			0°	1°	2°	3°			0°	1°	2°	3°			
m	°	m	kg	kg	kg	kg	°	m	kg	kg	kg	kg	m		
12,2	81,0	59,5	13 300	11 100									12,2		
13,7	79,5	59,2	13 300	11 100									13,7		
14,0	79,2	59,1	13 300	11 100									14,0		
15,2	78,0	58,8	13 200	11 100	8 900	7 400							15,2		
16,0	77,2	58,6	13 200	11 000	8 900	7 400							16,0		
16,8	76,4	58,4	13 000	11 000	8 900	7 400	80,1	58,0	12 000				16,8		
18,0	75,1	58,1	12 800	10 800	8 800	7 400	78,9	57,7	11 800				18,0		
18,3	74,8	58,0	12 700	10 800	8 800	7 400	78,5	57,6	11 700	10 100	8 900		18,3		
19,8	73,2	57,5	12 400	10 600	8 800	7 300	77,0	57,1	11 500	9 900	8 700	7 400	19,8		
20,0	73,0	57,5	12 400	10 500	8 800	7 300	76,8	57,1	11 500	9 900	8 700	7 400	20,0		
21,3	71,7	57,0	12 100	10 400	8 800	7 300	75,4	56,6	11 300	9 700	8 600	7 400	21,3		
22,0	71,0	56,8	12 000	10 300	8 800	7 300	74,7	56,4	11 100	9 600	8 500	7 400	22,0		
22,9	70,0	56,4	11 800	10 100	8 700	7 300	73,7	56,0	11 000	9 600	8 400	7 400	22,9		
24,0	68,8	56,0	11 600	10 000	8 700	7 300	72,5	55,6	10 800	9 400	8 400	7 400	24,0		
26,0	66,7	55,1	11 300	9 700	8 600	7 300	70,3	54,7	10 600	9 200	8 200	7 400	26,0		
28,0	64,5	54,1	11 000	9 500	8 400	7 200	68,1	53,7	10 300	9 000	8 000	7 200	28,0		
30,0	62,2	53,1	10 600	9 200	8 200	7 200	65,9	52,6	10 000	8 800	7 900	7 100	30,0		
32,0	59,9	51,9	10 300	9 000	8 000	7 200	63,5	51,5	9 800	8 700	7 800	7 000	32,0		
36,0	55,2	49,2	9 800	8 600	7 700	6 900	58,7	48,8	9 300	8 300	7 500	6 800	36,0		
40,0	50,1	46,0	9 200	8 200	7 400	6 700	53,6	45,5	8 700	8 000	7 200	6 600	40,0		
44,0	44,6	42,2	8 800	7 800	7 100	6 500	48,0	41,6	7 900	7 700	7 000	6 400	44,0		
48,0	38,4	37,4	8 400	7 500	6 800	6 300	41,8	36,8	7 300	7 300	6 900	6 300	48,0		
48,8	37,1	36,2	8 300	7 500	6 800	6 200	40,4	35,6	7 200	7 200	6 800	6 300	48,8		
52,0	31,3	31,4	7 900	7 300	6 600	6 100	34,4	30,6	6 900	6 800	6 700	6 200	52,0		
53,3	28,2	28,5	7 700	7 200	6 600	6 000	31,6	28,1	6 700	6 700	6 600	6 200	53,3		
56,0	22,0	22,9	7 300	7 100	6 500	6 000							56,0		
56,4	20,9	21,8	7 200	7 100	6 500	6 000							56,4		

MLC250 S-2

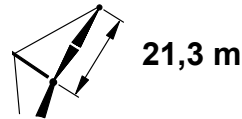
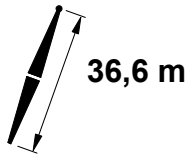

		25°					
		83 730 kg + 19 960 kg					
m	°	m	0° kg	1° kg	2° kg	3° kg	m
12,2							12,2
13,7							13,7
14,0							14,0
15,2							15,2
16,0							16,0
16,8							16,8
18,0							18,0
18,3							18,3
19,8	80,8	56,2	10 500				19,8
20,0	80,6	56,1	10 500				20,0
21,3	79,2	55,6	10 300	9 100			21,3
22,0	78,4	55,4	10 200	9 000			22,0
22,9	77,5	55,0	10 000	8 900	8 000	7 200	22,9
24,0	76,3	54,6	9 800	8 900	7 900	7 200	24,0
26,0	74,0	53,7	9 200	8 700	7 800	7 100	26,0
28,0	71,8	52,7	8 800	8 500	7 700	7 000	28,0
30,0	69,5	51,6	8 300	8 200	7 600	6 900	30,0
32,0	67,1	50,4	8 000	7 800	7 500	6 800	32,0
36,0	62,2	47,6	7 300	7 200	7 100	6 700	36,0
40,0	56,9	44,3	6 800	6 700	6 600	6 500	40,0
44,0	51,2	40,2	6 300	6 300	6 200	6 100	44,0
48,0	44,7	35,2	6 000	5 900	5 900	5 800	48,0
48,8	43,3	34,1	5 900	5 900	5 800	5 800	48,8
52,0							52,0
53,3							53,3
56,0							56,0
56,4							56,4

MLC250 S-2

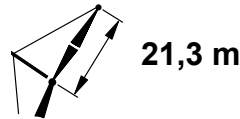
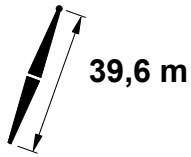

		5°					15°						
			0°	1°	2°	3°			0°	1°	2°	3°	
m	°	m	kg	kg	kg	kg	°	m	kg	kg	kg	kg	m
13,7	80,0	62,3	13 300										13,7
14,0	79,7	62,2	13 300										14,0
15,2	78,6	61,9	13 300	11 000	8 900								15,2
16,0	77,8	61,8	13 200	11 000	8 800								16,0
16,8	77,0	61,6	13 100	11 000	8 800	7 300	80,6	61,2	12 000				16,8
18,0	75,9	61,3	12 900	10 900	8 800	7 300	79,4	60,9	11 800				18,0
18,3	75,6	61,2	12 800	10 900	8 800	7 300	79,1	60,8	11 800	10 100			18,3
19,8	74,1	60,7	12 500	10 600	8 800	7 300	77,6	60,3	11 600	9 900	8 800	7 400	19,8
20,0	73,9	60,7	12 500	10 600	8 800	7 300	77,5	60,3	11 500	9 900	8 800	7 400	20,0
21,3	72,6	60,2	12 300	10 400	8 700	7 300	76,2	59,8	11 300	9 800	8 600	7 400	21,3
22,0	71,9	60,0	12 100	10 300	8 700	7 300	75,5	59,6	11 200	9 700	8 600	7 400	22,0
22,9	71,0	59,7	12 000	10 200	8 700	7 300	74,6	59,3	11 100	9 600	8 500	7 400	22,9
24,0	69,9	59,3	11 800	10 100	8 700	7 300	73,4	58,8	10 900	9 500	8 400	7 400	24,0
24,4	69,5	59,1	11 700	10 000	8 700	7 300	73,0	58,7	10 900	9 500	8 400	7 400	24,4
26,0	67,9	58,4	11 400	9 800	8 600	7 200	71,4	58,0	10 700	9 300	8 300	7 400	26,0
28,0	65,8	57,5	11 100	9 600	8 500	7 200	69,3	57,1	10 400	9 100	8 100	7 300	28,0
30,0	63,7	56,5	10 800	9 300	8 300	7 200	67,2	56,1	10 200	9 000	8 000	7 200	30,0
32,0	61,6	55,4	10 500	9 100	8 100	7 200	65,0	55,0	9 900	8 800	7 800	7 100	32,0
36,0	57,2	53,0	9 900	8 700	7 800	7 000	60,6	52,5	9 400	8 400	7 600	6 900	36,0
40,0	52,5	50,0	9 500	8 300	7 500	6 800	55,8	49,5	9 000	8 100	7 400	6 700	40,0
44,0	47,5	46,5	9 000	8 000	7 200	6 500	50,8	45,9	8 300	7 800	7 100	6 500	44,0
48,0	42,0	42,3	8 600	7 700	7 000	6 300	45,2	41,7	7 600	7 600	7 000	6 400	48,0
51,8	36,1	37,3	8 200	7 400	6 700	6 200	39,2	36,6	7 200	7 100	6 800	6 300	51,8
52,0	35,9	37,1	8 200	7 400	6 700	6 200	39,0	36,4	7 100	7 100	6 800	6 300	52,0
56,0	28,5	30,4	7 700	7 200	6 600	6 000	31,5	29,5	6 700	6 700	6 600	6 200	56,0
56,4	27,6	29,5	7 600	7 200	6 600	6 000	30,6	28,7	6 700	6 600	6 600	6 200	56,4
59,4	20,3	22,4	7 000	6 900	6 400	5 900							59,4

MLC250 S-2

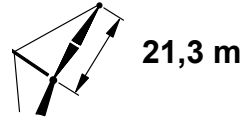
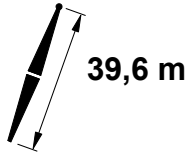
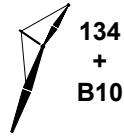

				 25°					
				0°	1°	2°	3°		
				kg	kg	kg	kg		
m	°	m						m	
13,7								13,7	
14,0								14,0	
15,2								15,2	
16,0								16,0	
16,8								16,8	
18,0								18,0	
18,3								18,3	
19,8								19,8	
20,0								20,0	
21,3	79,8	58,8		10 400	9 100			21,3	
22,0	79,1	58,6		10 300	9 100			22,0	
22,9	78,1	58,2		10 100	9 000	8 000		22,9	
24,0	77,0	57,8		9 900	8 900	7 900		24,0	
24,4	76,6	57,7		9 800	8 900	7 900	7 200	24,4	
26,0	74,9	57,0		9 400	8 800	7 800	7 100	26,0	
28,0	72,8	56,0		9 000	8 600	7 700	7 000	28,0	
30,0	70,6	55,0		8 600	8 400	7 600	6 900	30,0	
32,0	68,4	53,9		8 200	8 000	7 500	6 900	32,0	
36,0	63,9	51,3		7 500	7 400	7 300	6 700	36,0	
40,0	59,0	48,3		7 000	6 900	6 800	6 600	40,0	
44,0	53,8	44,6		6 500	6 400	6 400	6 300	44,0	
48,0	48,1	40,2		6 100	6 100	6 000	6 000	48,0	
51,8	41,8	34,9		5 800	5 800	5 800	5 700	51,8	
52,0								52,0	
56,0								56,0	
56,4								56,4	
59,4								59,4	

MLC250 S-2

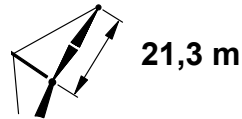
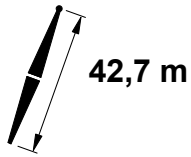

			5°				15°						
m	°	m	kg	kg	kg	kg	°	m	kg	kg	kg	kg	m
13,7	80,5	65,4	13 300										13,7
14,0	80,2	65,3	13 300										14,0
15,2	79,1	65,1	13 300	11 000									15,2
16,0	78,4	64,9	13 300	10 900									16,0
16,8	77,7	64,7	13 200	10 900	8 800	7 300							16,8
18,0	76,6	64,4	13 000	10 900	8 800	7 300							18,0
18,3	76,3	64,3	12 900	10 800	8 800	7 300	79,7	63,9	11 800	10 100			18,3
19,8	74,9	63,9	12 700	10 700	8 700	7 300	78,3	63,5	11 600	10 000	8 800		19,8
20,0	74,7	63,9	12 600	10 700	8 700	7 300	78,1	63,4	11 600	10 000	8 800		20,0
21,3	73,5	63,4	12 400	10 500	8 700	7 300	76,9	63,0	11 400	9 800	8 700	7 400	21,3
22,0	72,8	63,2	12 300	10 400	8 700	7 300	76,2	62,8	11 300	9 800	8 600	7 400	22,0
22,9	72,0	62,9	12 100	10 300	8 700	7 200	75,3	62,5	11 200	9 700	8 500	7 400	22,9
24,0	70,9	62,5	11 900	10 200	8 600	7 200	74,3	62,1	11 100	9 600	8 400	7 400	24,0
24,4	70,5	62,4	11 800	10 100	8 600	7 200	73,9	61,9	11 000	9 500	8 400	7 400	24,4
26,0	69,0	61,7	11 600	9 900	8 600	7 200	72,3	61,3	10 800	9 400	8 300	7 400	26,0
28,0	67,1	60,9	11 300	9 700	8 500	7 200	70,4	60,4	10 500	9 200	8 200	7 400	28,0
30,0	65,1	60,0	11 000	9 500	8 400	7 100	68,4	59,5	10 300	9 000	8 000	7 200	30,0
32,0	63,1	58,9	10 700	9 300	8 200	7 100	66,4	58,5	10 000	8 900	7 900	7 100	32,0
36,0	58,9	56,6	10 100	8 900	7 900	7 100	62,2	56,1	9 600	8 500	7 700	7 000	36,0
40,0	54,6	53,9	9 700	8 500	7 600	6 900	57,8	53,3	9 200	8 200	7 400	6 700	40,0
44,0	50,0	50,6	9 200	8 100	7 300	6 600	53,1	50,1	8 600	8 000	7 200	6 600	44,0
48,0	45,0	46,8	8 800	7 800	7 100	6 400	48,1	46,2	8 000	7 700	7 000	6 400	48,0
52,0	39,6	42,2	8 400	7 500	6 900	6 200	42,6	41,5	7 400	7 300	6 900	6 300	52,0
53,3	37,5	40,3	8 200	7 500	6 800	6 200	40,5	39,6	7 300	7 200	6 800	6 300	53,3
56,0	33,4	36,5	7 800	7 300	6 600	6 100	36,3	35,8	7 000	6 900	6 800	6 200	56,0
59,4	26,9	30,2	6 900	6 700	6 400	6 000	29,7	29,4	6 600	6 600	6 500	6 200	59,4
60,0	25,8	29,1	6 700	6 500	6 300	6 000							60,0
62,5	19,8	22,9	6 200	6 000	5 800	5 700							62,5

MLC250 S-2

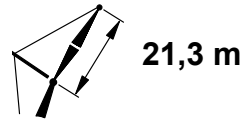
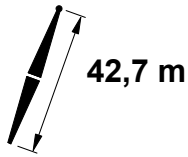
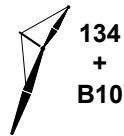

		25°						
m	°	m	kg	kg	kg	kg	m	
13,7							13,7	
14,0							14,0	
15,2							15,2	
16,0							16,0	
16,8							16,8	
18,0							18,0	
18,3							18,3	
19,8							19,8	
20,0							20,0	
21,3	80,3	62,0	10 400				21,3	
22,0	79,6	61,8	10 300				22,0	
22,9	78,8	61,4	10 200	9 000	8 000		22,9	
24,0	77,7	61,1	10 100	8 900	8 000		24,0	
24,4	77,3	60,9	10 000	8 900	7 900	7 200	24,4	
26,0	75,7	60,3	9 600	8 800	7 900	7 100	26,0	
28,0	73,7	59,4	9 200	8 700	7 800	7 000	28,0	
30,0	71,7	58,4	8 700	8 500	7 700	7 000	30,0	
32,0	69,6	57,4	8 400	8 200	7 600	6 900	32,0	
36,0	65,4	55,0	7 700	7 600	7 400	6 800	36,0	
40,0	60,9	52,1	7 200	7 100	7 000	6 700	40,0	
44,0	56,1	48,8	6 700	6 600	6 500	6 500	44,0	
48,0	50,9	44,8	6 300	6 300	6 200	6 100	48,0	
52,0	45,2	39,9	6 000	5 900	5 900	5 900	52,0	
53,3	43,1	38,1	5 900	5 900	5 800	5 800	53,3	
56,0							56,0	
59,4							59,4	
60,0							60,0	
62,5							62,5	

CAPACITY CHART ONLY!

MLC250 S-2

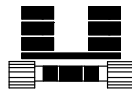

83 730 kg
+
19 960 kg

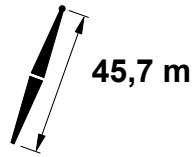

45,7 m



21,3 m

		5°						15°						
			0°	1°	2°	3°			0°	1°	2°	3°		
m	°	m	kg	kg	kg	kg	°	m	kg	kg	kg	kg	m	
13,7	80,9	68,5	13 300										13,7	
14,0	80,7	68,4	13 300										14,0	
15,2	79,6	68,2	13 300	10 900									15,2	
16,0	79,0	68,0	13 300	10 900									16,0	
16,8	78,2	67,8	13 200	10 800	8 700								16,8	
18,0	77,2	67,6	13 100	10 800	8 700								18,0	
18,3	76,9	67,5	13 000	10 800	8 700	7 200	80,2	67,1	11 900				18,3	
19,8	75,6	67,1	12 700	10 700	8 700	7 200	78,8	66,7	11 700	10 000	8 800		19,8	
20,0	75,4	67,0	12 700	10 700	8 700	7 200	78,6	66,6	11 700	10 000	8 800		20,0	
21,3	74,3	66,6	12 500	10 600	8 600	7 200	77,5	66,2	11 500	9 900	8 700	7 300	21,3	
22,0	73,6	66,4	12 400	10 500	8 600	7 200	76,8	66,0	11 400	9 800	8 600	7 300	22,0	
22,9	72,8	66,1	12 200	10 400	8 600	7 200	76,0	65,7	11 300	9 700	8 600	7 300	22,9	
24,0	71,8	65,8	12 000	10 200	8 600	7 200	75,0	65,3	11 100	9 600	8 500	7 300	24,0	
24,4	71,5	65,6	12 000	10 200	8 600	7 200	74,7	65,2	11 100	9 600	8 500	7 300	24,4	
26,0	70,0	65,0	11 700	10 000	8 600	7 200	73,2	64,6	10 900	9 400	8 400	7 300	26,0	
28,0	68,2	64,2	11 400	9 800	8 500	7 100	71,3	63,8	10 600	9 300	8 200	7 300	28,0	
30,0	66,3	63,3	11 100	9 600	8 400	7 100	69,5	62,9	10 400	9 100	8 100	7 300	30,0	
32,0	64,4	62,4	10 800	9 300	8 300	7 100	67,5	61,9	10 200	8 900	8 000	7 200	32,0	
36,0	60,5	60,2	10 300	9 000	8 000	7 100	63,6	59,7	9 700	8 600	7 700	7 000	36,0	
40,0	56,4	57,6	9 800	8 600	7 700	6 900	59,5	57,1	9 400	8 300	7 500	6 800	40,0	
44,0	52,2	54,6	9 400	8 300	7 400	6 700	55,2	54,1	8 900	8 100	7 300	6 600	44,0	
48,0	47,6	51,1	9 000	8 000	7 200	6 500	50,6	50,5	8 200	7 800	7 100	6 500	48,0	
52,0	42,7	46,9	8 600	7 700	6 900	6 300	45,6	46,3	7 700	7 600	6 900	6 400	52,0	
56,0	37,2	42,0	7 500	7 200	6 800	6 200	40,1	41,3	7 200	7 100	6 800	6 300	56,0	
56,4	36,6	41,4	7 400	7 100	6 700	6 100	39,4	40,6	7 200	7 100	6 700	6 200	56,4	
60,0	31,0	35,8	6 500	6 200	6 000	5 800	33,6	35,0	6 600	6 400	6 200	6 000	60,0	
61,0	29,1	33,8	6 300	6 000	5 800	5 600	31,9	33,2	6 400	6 200	6 000	5 800	61,0	
64,0	23,1	27,5	5 600	5 400	5 200	5 000							64,0	
65,5	19,3	23,3	5 200	5 100	4 900	4 800							65,5	

MLC250 S-2

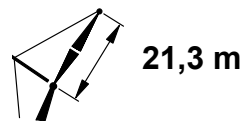
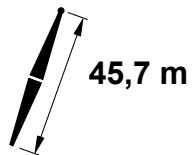

				25°					
				0°	1°	2°	3°		
m	°	m	kg	kg	kg	kg	kg	m	
13,7								13,7	
14,0								14,0	
15,2								15,2	
16,0								16,0	
16,8								16,8	
18,0								18,0	
18,3								18,3	
19,8								19,8	
20,0								20,0	
21,3	80,8	65,2	10 500					21,3	
22,0	80,1	65,0	10 400					22,0	
22,9	79,3	64,6	10 300	9 000				22,9	
24,0	78,3	64,3	10 200	9 000				24,0	
24,4	77,9	64,1	10 100	9 000	8 000	7 200		24,4	
26,0	76,4	63,5	9 800	8 900	7 900	7 100		26,0	
28,0	74,5	62,7	9 300	8 700	7 800	7 000		28,0	
30,0	72,6	61,8	8 900	8 600	7 700	7 000		30,0	
32,0	70,7	60,8	8 600	8 400	7 600	6 900		32,0	
36,0	66,7	58,5	7 900	7 800	7 500	6 800		36,0	
40,0	62,5	55,9	7 400	7 200	7 100	6 700		40,0	
44,0	58,1	52,8	6 900	6 800	6 700	6 600		44,0	
48,0	53,3	49,1	6 500	6 400	6 300	6 300		48,0	
52,0	48,2	44,8	6 100	6 100	6 000	6 000		52,0	
56,0	42,4	39,5	5 900	5 800	5 800	5 800		56,0	
56,4	41,8	39,0	5 800	5 800	5 800	5 700		56,4	
60,0								60,0	
61,0								61,0	
64,0								64,0	
65,5								65,5	

MLC250 S-2

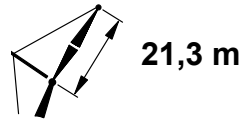
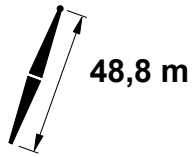

		5°					15°						
			0°	1°	2°	3°			0°	1°	2°	3°	
m	°	m	kg	kg	kg	kg	°	m	kg	kg	kg	kg	m
15,2	80,1	71,3	13 300										15,2
16,0	79,4	71,1	13 300										16,0
16,8	78,8	71,0	13 200	10 800	8 700								16,8
18,0	77,8	70,7	13 100	10 800	8 700								18,0
18,3	77,5	70,6	13 100	10 700	8 700	7 200	80,6	70,2	11 900				18,3
19,8	76,2	70,2	12 800	10 700	8 600	7 200	79,3	69,8	11 700	10 000			19,8
20,0	76,1	70,2	12 800	10 700	8 600	7 200	79,2	69,8	11 700	10 000			20,0
21,3	75,0	69,8	12 600	10 600	8 600	7 200	78,0	69,4	11 600	9 900	8 700		21,3
22,0	74,4	69,6	12 400	10 600	8 600	7 200	77,4	69,2	11 500	9 800	8 700		22,0
22,9	73,6	69,3	12 300	10 500	8 600	7 200	76,7	68,9	11 300	9 700	8 600	7 300	22,9
24,0	72,7	69,0	12 100	10 300	8 600	7 100	75,7	68,5	11 200	9 600	8 500	7 300	24,0
24,4	72,3	68,8	12 100	10 300	8 600	7 100	75,4	68,4	11 200	9 600	8 500	7 300	24,4
25,9	71,0	68,3	11 800	10 100	8 500	7 100	74,1	67,9	11 000	9 500	8 400	7 300	25,9
26,0	70,9	68,3	11 800	10 100	8 500	7 100	74,0	67,8	11 000	9 500	8 400	7 300	26,0
28,0	69,2	67,5	11 500	9 900	8 500	7 100	72,2	67,1	10 700	9 300	8 300	7 300	28,0
30,0	67,4	66,7	11 200	9 700	8 400	7 100	70,4	66,2	10 500	9 200	8 100	7 300	30,0
32,0	65,6	65,8	11 000	9 500	8 300	7 100	68,6	65,3	10 300	9 000	8 000	7 200	32,0
36,0	61,9	63,7	10 500	9 100	8 000	7 000	64,9	63,2	9 900	8 700	7 800	7 000	36,0
40,0	58,1	61,3	10 000	8 700	7 700	7 000	61,1	60,8	9 500	8 400	7 600	6 800	40,0
44,0	54,1	58,5	9 600	8 400	7 500	6 800	57,0	57,9	9 100	8 200	7 400	6 700	44,0
48,0	49,9	55,2	9 100	8 100	7 300	6 600	52,8	54,7	8 500	7 900	7 200	6 500	48,0
52,0	45,4	51,4	8 500	7 800	7 000	6 400	48,2	50,8	8 000	7 700	7 000	6 400	52,0
56,0	40,5	47,0	7 300	7 000	6 700	6 200	43,2	46,3	7 500	7 200	6 900	6 300	56,0
59,4	35,8	42,3	6 400	6 200	5 900	5 600	38,4	41,6	6 600	6 400	6 100	5 800	59,4
60,0	35,0	41,6	6 300	6 000	5 800	5 600	37,7	40,8	6 500	6 200	6 000	5 700	60,0
64,0	28,6	34,8	5 400	5 200	5 000	4 800	31,1	33,9	5 500	5 300	5 100	4 900	64,0
68,0	20,3	25,6	4 600	4 400	4 300	4 100							68,0
68,6	18,8	23,8	4 500	4 300	4 200	4 000							68,6

MLC250 S-2

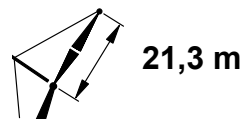
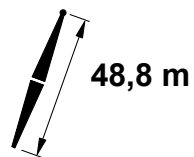

 25°									
				0°	1°	2°	3°		
m	°	m	kg	kg	kg	kg	kg	m	
15,2								15,2	
16,0								16,0	
16,8								16,8	
18,0								18,0	
18,3								18,3	
19,8								19,8	
20,0								20,0	
21,3								21,3	
22,0								22,0	
22,9	79,8	67,8	10 300	9 100				22,9	
24,0	78,8	67,5	10 200	9 000				24,0	
24,4	78,5	67,3	10 200	9 000	8 000			24,4	
25,9	77,1	66,8	10 000	8 900	7 900	7 100		25,9	
26,0	77,1	66,8	9 900	8 900	7 900	7 100		26,0	
28,0	75,3	66,0	9 500	8 700	7 800	7 100		28,0	
30,0	73,5	65,1	9 100	8 600	7 700	7 000		30,0	
32,0	71,6	64,2	8 700	8 500	7 600	6 900		32,0	
36,0	67,8	62,0	8 100	7 900	7 500	6 800		36,0	
40,0	63,9	59,6	7 500	7 400	7 300	6 700		40,0	
44,0	59,8	56,7	7 100	7 000	6 900	6 600		44,0	
48,0	55,4	53,3	6 600	6 600	6 500	6 400		48,0	
52,0	50,7	49,3	6 300	6 200	6 200	6 100		52,0	
56,0	45,6	44,7	6 000	6 000	5 900	5 900		56,0	
59,4	40,6	39,8	5 800	5 800	5 700	5 700		59,4	
60,0								60,0	
64,0								64,0	
68,0								68,0	
68,6								68,6	

MLC250 S-2

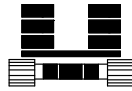
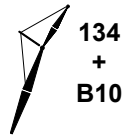

83 730 kg
+
19 960 kg

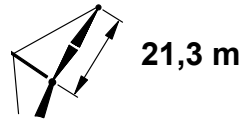
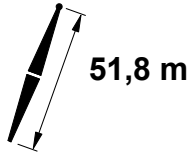

		5°						15°						
			0°	1°	2°	3°			0°	1°	2°	3°		
m	°	m	kg	kg	kg	kg	°	m	kg	kg	kg	kg	m	
15,2	80,5	74,4	13 300										15,2	
16,0	79,9	74,3	13 300										16,0	
16,8	79,2	74,1	13 300	10 700									16,8	
18,0	78,3	73,8	13 200	10 700									18,0	
18,3	78,0	73,7	13 100	10 700	8 600		81,0	73,3	12 000				18,3	
19,8	76,8	73,4	12 900	10 600	8 600	7 100	79,8	72,9	11 800	10 000			19,8	
20,0	76,7	73,3	12 900	10 600	8 600	7 100	79,6	72,9	11 700	10 000			20,0	
21,3	75,6	73,0	12 600	10 600	8 500	7 100	78,6	72,5	11 600	9 900	8 700		21,3	
22,0	75,0	72,8	12 500	10 500	8 500	7 100	78,0	72,4	11 500	9 900	8 700		22,0	
22,9	74,3	72,5	12 400	10 500	8 500	7 100	77,2	72,1	11 400	9 800	8 600	7 200	22,9	
24,0	73,4	72,2	12 200	10 400	8 500	7 100	76,3	71,7	11 300	9 700	8 500	7 200	24,0	
24,4	73,1	72,1	12 100	10 300	8 500	7 100	76,0	71,6	11 200	9 600	8 500	7 200	24,4	
25,9	71,8	71,6	11 900	10 200	8 500	7 100	74,8	71,1	11 100	9 500	8 400	7 200	25,9	
26,0	71,8	71,5	11 900	10 200	8 500	7 100	74,7	71,1	11 000	9 500	8 400	7 200	26,0	
28,0	70,1	70,8	11 600	9 900	8 400	7 100	73,0	70,3	10 800	9 400	8 300	7 200	28,0	
30,0	68,4	70,0	11 300	9 700	8 400	7 100	71,3	69,5	10 600	9 200	8 200	7 200	30,0	
32,0	66,7	69,1	11 100	9 500	8 400	7 000	69,6	68,6	10 400	9 100	8 100	7 200	32,0	
36,0	63,2	67,2	10 600	9 200	8 100	7 000	66,1	66,7	10 000	8 800	7 800	7 100	36,0	
40,0	59,6	64,9	10 100	8 800	7 800	7 000	62,4	64,4	9 600	8 500	7 600	6 900	40,0	
44,0	55,8	62,2	9 700	8 500	7 600	6 900	58,6	61,7	9 200	8 200	7 400	6 700	44,0	
48,0	51,9	59,2	9 300	8 200	7 300	6 600	54,7	58,7	8 800	8 000	7 300	6 600	48,0	
52,0	47,7	55,7	8 300	7 900	7 100	6 400	50,5	55,1	8 200	7 800	7 100	6 500	52,0	
56,0	43,3	51,6	7 100	6 800	6 400	6 100	45,9	51,0	7 400	7 000	6 700	6 300	56,0	
60,0	38,4	46,8	6 100	5 800	5 500	5 300	41,0	46,1	6 300	6 000	5 700	5 500	60,0	
61,0	37,0	45,4	5 800	5 600	5 300	5 100	39,6	44,7	6 100	5 800	5 500	5 300	61,0	
64,0	32,8	41,0	5 200	4 900	4 700	4 500	35,3	40,2	5 400	5 100	4 900	4 700	64,0	
67,1	27,8	35,3	4 600	4 400	4 200	4 000	30,3	34,6	4 700	4 500	4 300	4 100	67,1	
68,0	26,3	33,6	4 400	4 200	4 000	3 800							68,0	
70,1	22,0	28,7	4 000	3 800	3 700	3 500							70,1	

MLC250 S-2

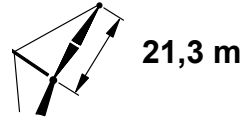
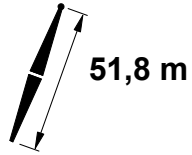
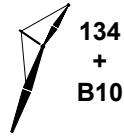

		25°					
 m	 °	 m	kg	kg	kg	kg	 m
15,2							15,2
16,0							16,0
16,8							16,8
18,0							18,0
18,3							18,3
19,8							19,8
20,0							20,0
21,3							21,3
22,0							22,0
22,9	80,3	71,0	10 400				22,9
24,0	79,3	70,7	10 300				24,0
24,4	79,0	70,5	10 200	9 000			24,4
25,9	77,7	70,0	10 100	8 900	7 900	7 100	25,9
26,0	77,6	70,0	10 100	8 900	7 900	7 100	26,0
28,0	75,9	69,2	9 700	8 800	7 800	7 100	28,0
30,0	74,2	68,4	9 300	8 700	7 800	7 000	30,0
32,0	72,5	67,5	8 900	8 600	7 700	6 900	32,0
36,0	68,9	65,5	8 200	8 100	7 500	6 800	36,0
40,0	65,2	63,2	7 700	7 600	7 400	6 700	40,0
44,0	61,3	60,4	7 200	7 100	7 000	6 700	44,0
48,0	57,2	57,3	6 800	6 700	6 600	6 500	48,0
52,0	52,9	53,7	6 500	6 400	6 300	6 300	52,0
56,0	48,3	49,4	6 200	6 100	6 000	6 000	56,0
60,0	43,1	44,4	5 900	5 900	5 800	5 700	60,0
61,0	41,8	43,0	5 800	5 800	5 700	5 500	61,0
64,0							64,0
67,1							67,1
68,0							68,0
70,1							70,1

MLC250 S-2



83 730 kg
+
19 960 kg

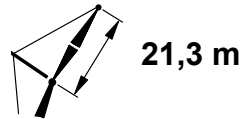
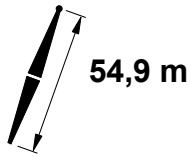

		5°					15°						
			0°	1°	2°	3°			0°	1°	2°	3°	
m	°	m	kg	kg	kg	kg	°	m	kg	kg	kg	kg	m
15,2	80,9	77,5	13 300										15,2
16,0	80,3	77,4	13 300										16,0
16,8	79,7	77,2	13 300	10 600									16,8
18,0	78,8	76,9	13 200	10 600									18,0
18,3	78,5	76,9	13 200	10 600	8 500								18,3
19,8	77,4	76,5	12 900	10 600	8 500	7 100	80,2	76,1	11 800				19,8
20,0	77,2	76,5	12 900	10 600	8 500	7 100	80,1	76,0	11 800				20,0
21,3	76,2	76,1	12 700	10 500	8 500	7 100	79,0	75,7	11 600	9 900			21,3
22,0	75,7	76,0	12 600	10 500	8 500	7 100	78,5	75,5	11 500	9 900			22,0
22,9	75,0	75,7	12 400	10 400	8 500	7 100	77,8	75,2	11 400	9 800	8 600	7 200	22,9
24,0	74,1	75,4	12 300	10 400	8 500	7 100	76,9	74,9	11 300	9 700	8 500	7 200	24,0
24,4	73,8	75,3	12 200	10 300	8 400	7 100	76,6	74,8	11 300	9 700	8 500	7 200	24,4
25,9	72,6	74,8	12 000	10 200	8 400	7 000	75,4	74,3	11 100	9 600	8 400	7 200	25,9
26,0	72,5	74,7	12 000	10 200	8 400	7 000	75,3	74,3	11 100	9 600	8 400	7 200	26,0
27,4	71,4	74,3	11 800	10 000	8 400	7 000	74,2	73,8	10 900	9 400	8 300	7 200	27,4
28,0	70,9	74,0	11 700	10 000	8 400	7 000	73,7	73,6	10 900	9 400	8 300	7 200	28,0
30,0	69,3	73,3	11 500	9 800	8 300	7 000	72,1	72,8	10 700	9 200	8 200	7 200	30,0
32,0	67,7	72,4	11 200	9 600	8 300	7 000	70,5	72,0	10 500	9 100	8 100	7 200	32,0
36,0	64,4	70,6	10 700	9 200	8 100	6 900	67,1	70,1	10 100	8 800	7 900	7 100	36,0
40,0	60,9	68,4	10 300	8 900	7 900	6 900	63,7	67,9	9 700	8 600	7 700	6 900	40,0
44,0	57,4	65,9	9 800	8 600	7 600	6 900	60,1	65,4	9 400	8 300	7 500	6 800	44,0
48,0	53,7	63,1	9 300	8 300	7 400	6 700	56,4	62,5	9 000	8 100	7 300	6 600	48,0
52,0	49,8	59,8	8 100	7 700	7 200	6 500	52,5	59,2	8 400	7 900	7 100	6 500	52,0
56,0	45,7	56,1	6 900	6 500	6 200	5 900	48,3	55,4	7 200	6 800	6 500	6 200	56,0
60,0	41,2	51,7	5 900	5 600	5 300	5 000	43,8	51,0	6 100	5 800	5 500	5 300	60,0
64,0	36,3	46,5	5 000	4 700	4 500	4 300	38,8	45,7	5 200	4 900	4 700	4 500	64,0
68,0	30,7	40,2	4 200	4 000	3 800	3 600	33,0	39,3	4 300	4 100	3 900	3 700	68,0
70,1	27,1	36,0	3 800	3 600	3 500	3 300	29,6	35,3	3 900	3 800	3 600	3 400	70,1
72,0	23,9	32,1	3 500	3 300	3 200	3 000							72,0
73,2	21,6	29,2	3 300	3 100	3 000	2 800							73,2

MLC250 S-2

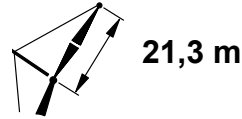
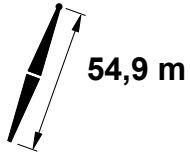
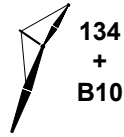

		25°					
		0°	1°	2°	3°		
		kg	kg	kg	kg		
		m	°	m			m
15,2							15,2
16,0							16,0
16,8							16,8
18,0							18,0
18,3							18,3
19,8							19,8
20,0							20,0
21,3							21,3
22,0							22,0
22,9	80,7	74,2	10 400				22,9
24,0	79,8	73,8	10 300				24,0
24,4	79,5	73,7	10 300	9 000			24,4
25,9	78,3	73,2	10 100	8 900	7 900		25,9
26,0	78,2	73,2	10 100	8 900	7 900		26,0
27,4	77,0	72,7	9 900	8 800	7 900	7 100	27,4
28,0	76,5	72,5	9 800	8 800	7 800	7 100	28,0
30,0	74,9	71,7	9 400	8 700	7 800	7 000	30,0
32,0	73,2	70,8	9 100	8 600	7 700	7 000	32,0
36,0	69,8	68,9	8 400	8 200	7 600	6 800	36,0
40,0	66,3	66,7	7 900	7 700	7 400	6 700	40,0
44,0	62,7	64,1	7 400	7 300	7 100	6 700	44,0
48,0	58,9	61,2	7 000	6 900	6 800	6 600	48,0
52,0	54,9	57,8	6 600	6 500	6 500	6 400	52,0
56,0	50,6	53,9	6 300	6 200	6 200	6 100	56,0
60,0	45,9	49,3	6 000	5 900	5 800	5 500	60,0
64,0	40,7	43,9	5 400	5 100	4 900	4 600	64,0
68,0							68,0
70,1							70,1
72,0							72,0
73,2							73,2

MLC250 S-2

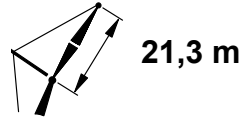
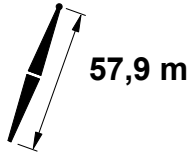
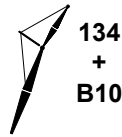

		5°						15°						
			0°	1°	2°	3°			0°	1°	2°	3°		
m	°	m	kg	kg	kg	kg	°	m	kg	kg	kg	kg	m	
16,8	80,1	80,3	13 300										16,8	
18,0	79,2	80,1	13 200										18,0	
18,3	79,0	80,0	13 200	10 500	8 500								18,3	
19,8	77,9	79,7	12 900	10 500	8 400	7 100	80,6	79,2	11 800				19,8	
20,0	77,7	79,6	12 900	10 500	8 400	7 000	80,4	79,2	11 800				20,0	
21,3	76,7	79,3	12 700	10 400	8 400	7 000	79,5	78,8	11 700	9 900			21,3	
22,0	76,2	79,1	12 600	10 400	8 400	7 000	78,9	78,7	11 600	9 900			22,0	
22,9	75,5	78,9	12 500	10 400	8 400	7 000	78,3	78,4	11 500	9 800	8 500		22,9	
24,0	74,7	78,6	12 300	10 400	8 400	7 000	77,4	78,1	11 300	9 700	8 500		24,0	
24,4	74,4	78,4	12 300	10 300	8 400	7 000	77,1	78,0	11 300	9 700	8 500	7 100	24,4	
25,9	73,3	78,0	12 100	10 200	8 400	7 000	76,0	77,5	11 200	9 600	8 400	7 100	25,9	
26,0	73,2	78,0	12 000	10 200	8 400	7 000	75,9	77,5	11 200	9 600	8 400	7 100	26,0	
27,4	72,1	77,5	11 900	10 100	8 300	7 000	74,8	77,0	11 000	9 500	8 400	7 100	27,4	
28,0	71,7	77,3	11 800	10 000	8 300	7 000	74,4	76,8	10 900	9 400	8 300	7 100	28,0	
30,0	70,1	76,6	11 500	9 800	8 300	6 900	72,8	76,1	10 700	9 300	8 200	7 100	30,0	
32,0	68,6	75,8	11 300	9 600	8 200	6 900	71,3	75,3	10 500	9 100	8 100	7 100	32,0	
36,0	65,4	74,0	10 800	9 300	8 200	6 900	68,1	73,5	10 200	8 900	7 900	7 100	36,0	
40,0	62,2	71,9	10 400	9 000	7 900	6 900	64,8	71,4	9 800	8 600	7 700	6 900	40,0	
44,0	58,8	69,6	10 000	8 700	7 700	6 800	61,4	69,0	9 500	8 400	7 500	6 800	44,0	
48,0	55,3	66,9	9 200	8 400	7 500	6 700	57,9	66,3	9 200	8 200	7 400	6 700	48,0	
52,0	51,7	63,8	7 800	7 400	6 900	6 500	54,2	63,2	8 200	7 700	7 200	6 600	52,0	
56,0	47,8	60,3	6 600	6 200	5 900	5 600	50,3	59,7	7 000	6 600	6 200	5 900	56,0	
60,0	43,7	56,3	5 600	5 300	5 000	4 700	46,2	55,6	5 900	5 600	5 300	5 000	60,0	
64,0	39,3	51,6	4 700	4 400	4 200	3 900	41,7	50,9	4 900	4 700	4 400	4 200	64,0	
65,5	37,4	49,5	4 400	4 200	3 900	3 700	39,7	48,7	4 600	4 400	4 100	3 900	65,5	
68,0	34,3	46,1	3 900	3 700	3 500	3 300	36,7	45,2	4 100	3 900	3 700	3 500	68,0	
71,6	29,2	39,9	3 300	3 100	2 900	2 700	31,4	39,0	3 400	3 200	3 100	2 900	71,6	
72,0	28,6	39,3	3 200	3 000	2 900	2 700							72,0	
76,0	21,5	30,3	2 600	2 400	2 300	2 200							76,0	
76,2	21,1	29,8	2 500	2 400	2 300	2 100							76,2	

MLC250 S-2

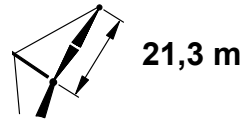
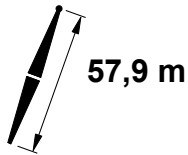
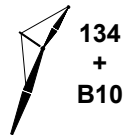

				25°					
				0°	1°	2°	3°		
m	°	m	kg	kg	kg	kg	kg	m	
16,8								16,8	
18,0								18,0	
18,3								18,3	
19,8								19,8	
20,0								20,0	
21,3								21,3	
22,0								22,0	
22,9								22,9	
24,0								24,0	
24,4	79,9	76,9	10 300	9 000				24,4	
25,9	78,7	76,4	10 200	8 900	7 900			25,9	
26,0	78,7	76,4	10 200	8 900	7 900			26,0	
27,4	77,6	75,9	10 000	8 800	7 900	7 100		27,4	
28,0	77,1	75,7	9 900	8 800	7 800	7 100		28,0	
30,0	75,5	74,9	9 600	8 700	7 800	7 000		30,0	
32,0	73,9	74,1	9 200	8 600	7 700	7 000		32,0	
36,0	70,7	72,3	8 600	8 400	7 600	6 900		36,0	
40,0	67,4	70,2	8 000	7 900	7 500	6 800		40,0	
44,0	63,9	67,8	7 500	7 400	7 300	6 700		44,0	
48,0	60,3	65,0	7 100	7 000	6 900	6 600		48,0	
52,0	56,6	61,9	6 700	6 700	6 600	6 500		52,0	
56,0	52,6	58,2	6 400	6 400	6 300	6 100		56,0	
60,0	48,3	54,0	6 100	5 800	5 500	5 200		60,0	
64,0	43,7	49,1	5 100	4 900	4 600	4 400		64,0	
65,5	41,7	47,0	4 800	4 500	4 300	4 100		65,5	
68,0								68,0	
71,6								71,6	
72,0								72,0	
76,0								76,0	
76,2								76,2	

MLC250 S-2

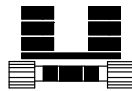

83 730 kg
+
19 960 kg

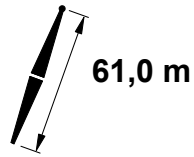

61,0 m



21,3 m

		5°						15°						
			0°	1°	2°	3°			0°	1°	2°	3°		
m	°	m	kg	kg	kg	kg	°	m	kg	kg	kg	kg	m	
16,8	80,5	83,4	13 300										16,8	
18,0	79,6	83,2	13 200										18,0	
18,3	79,4	83,1	13 200	10 400									18,3	
19,8	78,3	82,8	13 000	10 400	8 400		80,9	82,3	11 800				19,8	
20,0	78,2	82,7	13 000	10 400	8 400		80,8	82,3	11 800				20,0	
21,3	77,2	82,4	12 800	10 400	8 400	7 000	79,9	82,0	11 700	9 900			21,3	
22,0	76,7	82,3	12 700	10 300	8 300	7 000	79,4	81,8	11 600	9 900			22,0	
22,9	76,1	82,0	12 500	10 300	8 300	7 000	78,7	81,6	11 500	9 800	8 500		22,9	
24,0	75,3	81,7	12 400	10 300	8 300	6 900	77,9	81,3	11 400	9 700	8 500		24,0	
24,4	75,0	81,6	12 300	10 300	8 300	6 900	77,6	81,1	11 300	9 700	8 500	7 100	24,4	
25,9	73,9	81,2	12 100	10 200	8 300	6 900	76,5	80,7	11 200	9 600	8 400	7 100	25,9	
26,0	73,9	81,1	12 100	10 200	8 300	6 900	76,5	80,7	11 200	9 600	8 400	7 100	26,0	
27,4	72,8	80,7	11 900	10 100	8 300	6 900	75,4	80,2	11 000	9 500	8 400	7 100	27,4	
28,0	72,4	80,5	11 800	10 100	8 300	6 900	75,0	80,0	11 000	9 400	8 300	7 100	28,0	
29,0	71,7	80,2	11 700	10 000	8 200	6 900	74,2	79,7	10 900	9 400	8 300	7 100	29,0	
30,0	70,9	79,8	11 600	9 900	8 200	6 900	73,5	79,3	10 800	9 300	8 200	7 100	30,0	
32,0	69,4	79,0	11 400	9 700	8 200	6 900	72,0	78,6	10 600	9 200	8 100	7 100	32,0	
36,0	66,4	77,3	10 900	9 400	8 100	6 900	69,0	76,8	10 200	8 900	7 900	7 100	36,0	
40,0	63,3	75,4	10 500	9 000	8 000	6 800	65,8	74,9	9 900	8 700	7 700	7 000	40,0	
44,0	60,1	73,1	10 100	8 700	7 800	6 800	62,6	72,6	9 600	8 400	7 600	6 800	44,0	
48,0	56,8	70,6	9 000	8 300	7 500	6 800	59,3	70,0	9 200	8 200	7 400	6 700	48,0	
52,0	53,4	67,7	7 600	7 100	6 700	6 300	55,8	67,1	8 000	7 500	7 100	6 500	52,0	
56,0	49,8	64,4	6 400	6 000	5 700	5 300	52,2	63,8	6 800	6 400	6 000	5 600	56,0	
60,0	45,9	60,7	5 400	5 100	4 700	4 400	48,3	60,0	5 700	5 400	5 000	4 700	60,0	
64,0	41,9	56,4	4 500	4 200	4 000	3 700	44,2	55,7	4 800	4 500	4 200	3 900	64,0	
68,0	37,4	51,4	3 700	3 500	3 300	3 000	39,7	50,6	3 900	3 700	3 500	3 200	68,0	
68,6	36,7	50,5	3 600	3 400	3 200	2 900	38,9	49,7	3 800	3 600	3 400	3 100	68,6	
72,0	32,4	45,4	3 000	2 800	2 600	2 400	34,6	44,6	3 200	3 000	2 800	2 600	72,0	
74,7	28,5	40,5	2 600	2 400	2 200	2 100	30,7	39,7	2 700	2 600	2 400	2 200	74,7	
76,0	26,6	38,1	2 400	2 200	2 100	1 900							76,0	
76,2	26,2	37,6	2 400	2 200	2 000	1 900							76,2	
77,7	23,5	34,0	2 100	2 000	1 800								77,7	
79,3	20,7	30,3	1 900	1 800									79,3	

MLC250 S-2

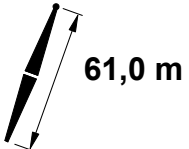
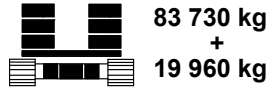
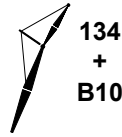

m	°	m	kg	kg	kg	kg	m
16,8							16,8
18,0							18,0
18,3							18,3
19,8							19,8
20,0							20,0
21,3							21,3
22,0							22,0
22,9							22,9
24,0							24,0
24,4	80,3	80,0	10 300				24,4
25,9	79,2	79,6	10 200	8 900			25,9
26,0	79,1	79,5	10 200	8 900			26,0
27,4	78,1	79,1	10 100	8 800	7 900		27,4
28,0	77,6	78,9	10 000	8 800	7 800		28,0
29,0	76,9	78,5	9 900	8 800	7 800	7 000	29,0
30,0	76,1	78,2	9 700	8 700	7 800	7 000	30,0
32,0	74,6	77,4	9 400	8 600	7 700	6 900	32,0
36,0	71,5	75,7	8 700	8 500	7 600	6 900	36,0
40,0	68,3	73,7	8 200	8 000	7 500	6 800	40,0
44,0	65,0	71,4	7 700	7 500	7 300	6 700	44,0
48,0	61,7	68,7	7 300	7 100	7 000	6 600	48,0
52,0	58,1	65,8	6 900	6 800	6 700	6 600	52,0
56,0	54,4	62,4	6 600	6 500	6 300	5 900	56,0
60,0	50,4	58,5	6 000	5 600	5 300	5 000	60,0
64,0	46,2	54,0	5 000	4 700	4 400	4 100	64,0
68,0	41,5	48,8	4 100	3 900	3 600	3 400	68,0
68,6	40,8	47,9	4 000	3 800	3 500	3 300	68,6
72,0							72,0
74,7							74,7
76,0							76,0
76,2							76,2
77,7							77,7
79,3							79,3

PRELIMINARY ONLY!

MLC250 S-2

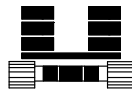

83 730 kg
+
19 960 kg

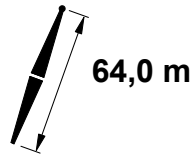

64,0 m

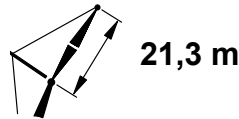





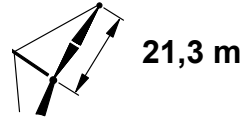
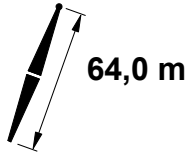
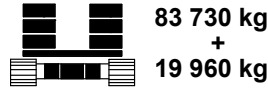
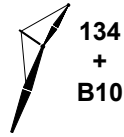

21,3 m

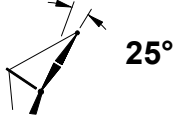
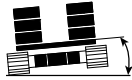
		5°						15°						
			0°	1°	2°	3°			0°	1°	2°	3°		
m	°	m	kg	kg	kg	kg	°	m	kg	kg	kg	kg	m	
16,8	80,8	86,5	13 300										16,8	
18,0	80,0	86,3	13 200										18,0	
18,3	79,8	86,2	13 200	10 300									18,3	
19,8	78,7	85,9	13 000	10 300	8 300								19,8	
20,0	78,6	85,9	13 000	10 300	8 300								20,0	
21,3	77,7	85,6	12 800	10 300	8 300	6 900	80,2	85,1	11 700				21,3	
22,0	77,2	85,4	12 700	10 200	8 300	6 900	79,8	84,9	11 600				22,0	
22,9	76,6	85,2	12 600	10 200	8 200	6 900	79,1	84,7	11 500	9 800			22,9	
24,0	75,8	84,9	12 400	10 200	8 200	6 900	78,4	84,4	11 400	9 700			24,0	
24,4	75,6	84,8	12 400	10 200	8 200	6 900	78,1	84,3	11 400	9 700	8 400		24,4	
25,9	74,5	84,3	12 200	10 200	8 200	6 900	77,0	83,9	11 200	9 600	8 400	7 000	25,9	
26,0	74,5	84,3	12 100	10 200	8 200	6 900	77,0	83,9	11 200	9 600	8 400	7 000	26,0	
27,4	73,5	83,9	12 000	10 100	8 200	6 900	76,0	83,4	11 100	9 500	8 300	7 000	27,4	
28,0	73,0	83,7	11 900	10 100	8 200	6 800	75,5	83,2	11 000	9 500	8 300	7 000	28,0	
29,0	72,3	83,4	11 800	10 000	8 200	6 800	74,8	82,9	10 900	9 400	8 300	7 000	29,0	
30,0	71,6	83,0	11 600	9 900	8 100	6 800	74,1	82,6	10 800	9 300	8 200	7 000	30,0	
32,0	70,2	82,3	11 400	9 700	8 100	6 800	72,7	81,8	10 700	9 200	8 100	7 000	32,0	
36,0	67,3	80,7	11 000	9 400	8 100	6 800	69,8	80,2	10 300	9 000	7 900	7 000	36,0	
40,0	64,3	78,8	10 600	9 100	8 000	6 800	66,8	78,3	10 000	8 700	7 800	7 000	40,0	
44,0	61,3	76,7	10 200	8 800	7 800	6 700	63,7	76,1	9 600	8 500	7 600	6 900	44,0	
48,0	58,1	74,2	8 800	8 200	7 500	6 700	60,6	73,7	9 200	8 300	7 400	6 700	48,0	
52,0	54,9	71,5	7 400	6 900	6 400	6 000	57,3	70,9	7 800	7 300	6 800	6 400	52,0	
56,0	51,5	68,4	6 200	5 800	5 400	5 000	53,8	67,8	6 600	6 100	5 700	5 400	56,0	
60,0	47,9	64,9	5 200	4 800	4 500	4 200	50,2	64,3	5 500	5 100	4 800	4 500	60,0	
64,0	44,1	60,9	4 300	4 000	3 700	3 400	46,4	60,3	4 600	4 200	4 000	3 700	64,0	
68,0	40,1	56,3	3 500	3 200	3 000	2 800	42,3	55,6	3 700	3 500	3 200	3 000	68,0	
70,1	37,7	53,5	3 100	2 900	2 700	2 400	39,9	52,8	3 300	3 100	2 900	2 600	70,1	
72,0	35,6	51,0	2 800	2 600	2 400	2 200	37,7	50,2	3 000	2 800	2 600	2 300	72,0	
74,7	32,2	46,8	2 400	2 200	2 000	1 800	34,3	45,9	2 500	2 300	2 200	2 000	74,7	
76,0	30,5	44,7	2 200	2 000	1 800		32,6	43,7	2 300	2 100	2 000		76,0	
76,2	30,2	44,3	2 100	2 000	1 800		32,3	43,3	2 300	2 100	1 900		76,2	
77,7	28,1	41,5	1 900				30,1	40,5	2 000	1 900			77,7	

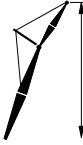
MLC250 S-2

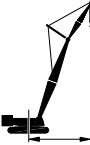

		 25°						
								
 m	 °	 m	 kg	 kg	 kg	 kg	 m	
16,8							16,8	
18,0							18,0	
18,3							18,3	
19,8							19,8	
20,0							20,0	
21,3							21,3	
22,0							22,0	
22,9							22,9	
24,0							24,0	
24,4	80,7	83,2	10 300				24,4	
25,9	79,6	82,7	10 200	8 900			25,9	
26,0	79,5	82,7	10 200	8 900			26,0	
27,4	78,5	82,3	10 100	8 900	7 900		27,4	
28,0	78,1	82,1	10 100	8 800	7 800		28,0	
29,0	77,4	81,7	9 900	8 800	7 800	7 000	29,0	
30,0	76,6	81,4	9 800	8 700	7 800	7 000	30,0	
32,0	75,2	80,7	9 500	8 700	7 700	6 900	32,0	
36,0	72,2	79,0	8 900	8 500	7 600	6 900	36,0	
40,0	69,2	77,1	8 300	8 100	7 500	6 800	40,0	
44,0	66,1	74,9	7 800	7 700	7 400	6 700	44,0	
48,0	62,8	72,4	7 400	7 300	7 200	6 600	48,0	
52,0	59,5	69,6	7 000	6 900	6 800	6 500	52,0	
56,0	56,0	66,4	6 700	6 500	6 100	5 700	56,0	
60,0	52,3	62,8	5 800	5 400	5 100	4 700	60,0	
64,0	48,4	58,6	4 800	4 500	4 200	3 900	64,0	
68,0	44,1	53,9	3 900	3 700	3 400	3 200	68,0	
70,1	41,7	51,0	3 500	3 300	3 000	2 800	70,1	
72,0							72,0	
74,7							74,7	
76,0							76,0	
76,2							76,2	
77,7							77,7	

MLC250 S-2

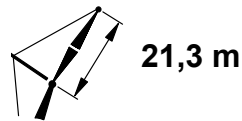
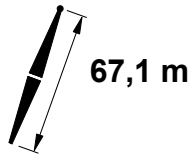

			5°				15°						
			0°	1°	2°	3°			0°	1°	2°	3°	
m	°	m	kg	kg	kg	kg	°	m	kg	kg	kg	kg	m
18,3	80,1	89,3	13 200										18,3
19,8	79,1	89,0	13 000	10 200									19,8
20,0	79,0	89,0	13 000	10 200									20,0
21,3	78,1	88,7	12 800	10 200	8 200		80,6	88,2	11 600				21,3
22,0	77,7	88,5	12 700	10 200	8 200		80,1	88,1	11 600				22,0
22,9	77,1	88,3	12 600	10 100	8 200	6 800	79,5	87,8	11 500	9 800			22,9
24,0	76,3	88,0	12 400	10 100	8 200	6 800	78,8	87,6	11 400	9 700			24,0
24,4	76,1	87,9	12 400	10 100	8 100	6 800	78,5	87,5	11 400	9 700	8 300		24,4
25,9	75,1	87,5	12 200	10 000	8 100	6 800	77,5	87,0	11 200	9 600	8 300	6 900	25,9
26,0	75,0	87,5	12 200	10 000	8 100	6 800	77,4	87,0	11 200	9 600	8 300	6 900	26,0
27,4	74,0	87,1	12 000	10 000	8 100	6 800	76,5	86,6	11 100	9 500	8 300	6 900	27,4
28,0	73,6	86,9	11 900	10 000	8 100	6 800	76,1	86,4	11 000	9 500	8 300	6 900	28,0
29,0	73,0	86,6	11 800	10 000	8 100	6 800	75,4	86,1	11 000	9 400	8 200	6 900	29,0
30,0	72,3	86,3	11 700	9 900	8 100	6 700	74,7	85,8	10 900	9 300	8 200	6 900	30,0
32,0	70,9	85,6	11 500	9 700	8 100	6 700	73,3	85,1	10 700	9 200	8 100	6 900	32,0
36,0	68,1	84,0	11 100	9 400	8 000	6 700	70,5	83,5	10 400	9 000	7 900	6 900	36,0
40,0	65,3	82,2	10 600	9 100	8 000	6 700	67,7	81,7	10 000	8 800	7 800	6 900	40,0
44,0	62,4	80,2	10 200	8 800	7 800	6 700	64,7	79,6	9 700	8 500	7 600	6 900	44,0
48,0	59,4	77,8	8 500	7 900	7 400	6 600	61,7	77,3	9 100	8 300	7 500	6 700	48,0
52,0	56,3	75,2	7 200	6 700	6 200	5 700	58,6	74,7	7 600	7 100	6 600	6 100	52,0
56,0	53,1	72,3	6 000	5 500	5 100	4 800	55,3	71,7	6 400	5 900	5 500	5 100	56,0
60,0	49,7	69,0	4 900	4 600	4 200	3 900	52,0	68,4	5 300	4 900	4 600	4 200	60,0
64,0	46,2	65,3	4 100	3 800	3 500	3 200	48,4	64,6	4 400	4 000	3 700	3 400	64,0
68,0	42,4	61,1	3 300	3 000	2 800	2 500	44,6	60,4	3 500	3 300	3 000	2 700	68,0
71,6	38,7	56,6	2 600	2 400	2 200	2 000	40,8	55,9	2 900	2 600	2 400	2 200	71,6
72,0	38,3	56,2	2 600	2 400	2 100		40,4	55,4	2 800	2 600	2 300	2 100	72,0
73,2	37,0	54,6	2 400	2 200	2 000		39,1	53,8	2 600	2 400	2 200	2 000	73,2
74,7	35,3	52,4	2 200	2 000			37,4	51,6	2 400	2 100	1 900		74,7
76,0	33,8	50,5	2 000				35,9	49,7	2 100	1 900			76,0
76,2	33,6	50,2	1 900				35,6	49,3	2 100	1 900			76,2
77,7							33,7	46,8	1 900				77,7

MLC250 S-2

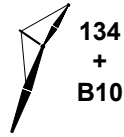

83 730 kg
+
19 960 kg

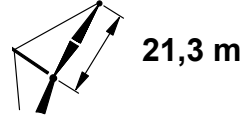
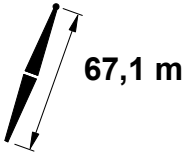

25°

m	°	m	kg				m
			0°	1°	2°	3°	
18,3							18,3
19,8							19,8
20,0							20,0
21,3							21,3
22,0							22,0
22,9							22,9
24,0							24,0
24,4	81,0	86,3	10 300				24,4
25,9	80,0	85,9	10 200	8 900			25,9
26,0	79,9	85,9	10 200	8 900			26,0
27,4	78,9	85,4	10 100	8 800	7 800		27,4
28,0	78,5	85,3	10 100	8 800	7 800		28,0
29,0	77,8	84,9	10 000	8 800	7 800	7 000	29,0
30,0	77,1	84,6	9 900	8 700	7 800	7 000	30,0
32,0	75,7	83,9	9 600	8 600	7 700	6 900	32,0
36,0	72,9	82,3	9 000	8 500	7 600	6 800	36,0
40,0	70,0	80,5	8 400	8 300	7 500	6 800	40,0
44,0	67,0	78,4	8 000	7 800	7 400	6 700	44,0
48,0	63,9	76,0	7 500	7 400	7 300	6 600	48,0
52,0	60,8	73,3	7 200	7 100	6 900	6 500	52,0
56,0	57,5	70,3	6 700	6 300	5 900	5 500	56,0
60,0	54,0	66,9	5 600	5 200	4 900	4 500	60,0
64,0	50,3	63,1	4 600	4 300	4 000	3 700	64,0
68,0	46,4	58,7	3 800	3 500	3 200	3 000	68,0
71,6	42,5	54,1	3 100	2 800	2 600	2 400	71,6
72,0	42,1	53,6	3 000	2 700	2 500	2 300	72,0
73,2	40,8	52,0	2 800	2 500	2 300	2 100	73,2
74,7							74,7
76,0							76,0
76,2							76,2
77,7							77,7

MLC250 S-2

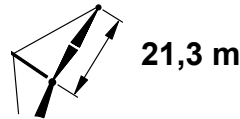
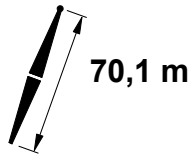

		5°						15°						
			0°	1°	2°	3°			0°	1°	2°	3°		
m	°	m	kg	kg	kg	kg	°	m	kg	kg	kg	kg	m	
18,3	80,5	92,4	13 200										18,3	
19,8	79,5	92,1	13 000	10 100									19,8	
20,0	79,4	92,1	12 900	10 100									20,0	
21,3	78,5	91,8	12 800	10 100	8 100		80,9	91,3	11 600				21,3	
22,0	78,1	91,7	12 700	10 000	8 100		80,5	91,2	11 600				22,0	
22,9	77,5	91,4	12 600	10 000	8 100	6 700	79,9	91,0	11 500	9 800			22,9	
24,0	76,8	91,2	12 400	10 000	8 100	6 700	79,2	90,7	11 400	9 700			24,0	
24,4	76,5	91,1	12 400	10 000	8 100	6 700	78,9	90,6	11 400	9 700	8 200		24,4	
25,9	75,6	90,7	12 200	9 900	8 000	6 700	77,9	90,2	11 200	9 600	8 200	6 900	25,9	
26,0	75,5	90,7	12 200	9 900	8 000	6 700	77,9	90,2	11 200	9 600	8 200	6 900	26,0	
27,4	74,6	90,3	12 000	9 900	8 000	6 700	76,9	89,8	11 100	9 500	8 200	6 900	27,4	
28,0	74,2	90,1	11 900	9 900	8 000	6 700	76,6	89,6	11 100	9 400	8 200	6 900	28,0	
29,0	73,6	89,8	11 800	9 900	8 000	6 700	75,9	89,3	11 000	9 400	8 200	6 900	29,0	
30,0	72,9	89,5	11 700	9 900	8 000	6 700	75,2	89,0	10 900	9 300	8 200	6 900	30,0	
30,5	72,6	89,3	11 700	9 800	8 000	6 700	74,9	88,8	10 800	9 300	8 200	6 900	30,5	
32,0	71,6	88,8	11 500	9 800	8 000	6 700	73,9	88,3	10 700	9 200	8 100	6 900	32,0	
36,0	68,9	87,3	11 100	9 500	7 900	6 600	71,2	86,8	10 400	9 000	7 900	6 900	36,0	
40,0	66,2	85,6	10 700	9 200	7 900	6 600	68,5	85,1	10 100	8 800	7 800	6 900	40,0	
44,0	63,4	83,6	9 900	8 900	7 800	6 600	65,7	83,1	9 800	8 600	7 600	6 900	44,0	
48,0	60,5	81,4	8 300	7 700	7 100	6 400	62,8	80,9	8 800	8 200	7 400	6 700	48,0	
52,0	57,6	78,9	6 900	6 400	5 900	5 400	59,8	78,4	7 400	6 800	6 300	5 800	52,0	
56,0	54,5	76,1	5 700	5 300	4 800	4 400	56,7	75,6	6 100	5 700	5 200	4 800	56,0	
60,0	51,3	73,0	4 700	4 300	3 900	3 600	53,5	72,4	5 100	4 700	4 300	3 900	60,0	
64,0	48,0	69,5	3 800	3 500	3 100	2 800	50,2	68,9	4 100	3 800	3 500	3 100	64,0	
68,0	44,5	65,6	3 000	2 700	2 500	2 200	46,6	64,9	3 300	3 000	2 700	2 500	68,0	
70,1	42,5	63,2	2 600	2 400	2 100	1 900	44,6	62,5	2 900	2 600	2 400	2 100	70,1	
71,6	41,0	61,5	2 400	2 100	1 900		43,1	60,8	2 600	2 400	2 100	1 900	71,6	
72,0	40,7	61,1	2 300	2 100			42,8	60,4	2 600	2 300	2 100		72,0	
73,2	39,5	59,6	2 100	1 900			41,6	58,8	2 400	2 100	1 900		73,2	
74,7	38,0	57,7	1 900				40,0	56,8	2 100	1 900			74,7	
76,0							38,6	55,1	1 900				76,0	
76,2							38,4	54,8	1 900				76,2	

MLC250 S-2

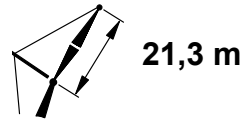
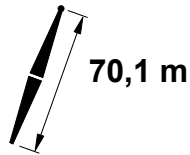
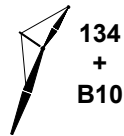

		25°					
		83 730 kg + 19 960 kg					
		0° 1° 2° 3°					
		kg					
m	°	m	kg				m
18,3							18,3
19,8							19,8
20,0							20,0
21,3							21,3
22,0							22,0
22,9							22,9
24,0							24,0
24,4							24,4
25,9	80,3	89,1	10 200				25,9
26,0	80,3	89,0	10 200				26,0
27,4	79,3	88,6	10 100	8 800			27,4
28,0	78,9	88,4	10 100	8 800			28,0
29,0	78,3	88,1	10 000	8 800	7 800		29,0
30,0	77,6	87,8	10 000	8 700	7 700		30,0
30,5	77,2	87,6	9 900	8 700	7 700	6 600	30,5
32,0	76,2	87,1	9 700	8 700	7 700	6 600	32,0
36,0	73,5	85,6	9 100	8 500	7 600	6 600	36,0
40,0	70,7	83,8	8 600	8 300	7 400	6 600	40,0
44,0	67,9	81,8	8 100	7 900	7 400	6 600	44,0
48,0	64,9	79,6	7 700	7 500	7 300	6 600	48,0
52,0	61,9	77,0	7 300	7 100	6 800	6 300	52,0
56,0	58,8	74,2	6 500	6 100	5 600	5 200	56,0
60,0	55,5	71,0	5 400	5 000	4 600	4 300	60,0
64,0	52,1	67,3	4 400	4 100	3 700	3 400	64,0
68,0	48,4	63,3	3 500	3 200	3 000	2 700	68,0
70,1	46,4	60,8	3 100	2 900	2 600	2 300	70,1
71,6	44,9	59,0	2 800	2 600	2 300	2 100	71,6
72,0	44,5	58,6	2 800	2 500	2 300	2 000	72,0
73,2	43,3	57,1	2 600	2 300	2 100	1 800	73,2
74,7	41,7	55,1	2 300	2 100	1 800		74,7
76,0							76,0
76,2							76,2

MLC250 S-2

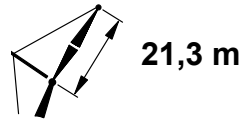
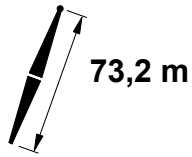

		5°						15°						
			0°	1°	2°	3°			0°	1°	2°	3°		
m	°	m	kg	kg	kg	kg	°	m	kg	kg	kg	kg	m	
18,3	80,8	95,5	13 100										18,3	
19,8	79,9	95,2	12 900	10 000									19,8	
20,0	79,7	95,2	12 900	10 000									20,0	
21,3	78,9	94,9	12 700	9 900	8 000								21,3	
22,0	78,5	94,8	12 700	9 900	8 000								22,0	
22,9	77,9	94,6	12 600	9 900	8 000	6 700	80,2	94,1	11 500				22,9	
24,0	77,2	94,3	12 400	9 900	8 000	6 600	79,5	93,8	11 400				24,0	
24,4	77,0	94,2	12 400	9 900	8 000	6 600	79,3	93,7	11 400	9 600			24,4	
25,9	76,1	93,8	12 200	9 800	8 000	6 600	78,3	93,4	11 200	9 600	8 100		25,9	
26,0	76,0	93,8	12 200	9 800	8 000	6 600	78,3	93,3	11 200	9 500	8 100		26,0	
27,4	75,1	93,4	12 000	9 800	7 900	6 600	77,4	92,9	11 100	9 500	8 100	6 800	27,4	
28,0	74,7	93,3	12 000	9 800	7 900	6 600	77,0	92,8	11 100	9 400	8 100	6 800	28,0	
29,0	74,1	93,0	11 900	9 800	7 900	6 600	76,4	92,5	11 000	9 400	8 100	6 800	29,0	
30,0	73,5	92,7	11 700	9 800	7 900	6 600	75,7	92,2	10 900	9 300	8 100	6 800	30,0	
30,5	73,2	92,5	11 700	9 800	7 900	6 600	75,4	92,0	10 900	9 300	8 100	6 800	30,5	
32,0	72,2	92,0	11 500	9 700	7 900	6 600	74,4	91,5	10 700	9 200	8 100	6 800	32,0	
36,0	69,6	90,6	11 100	9 500	7 800	6 600	71,9	90,1	10 400	9 000	7 900	6 800	36,0	
40,0	67,0	88,9	10 800	9 200	7 800	6 500	69,2	88,4	10 100	8 800	7 800	6 800	40,0	
44,0	64,3	87,0	9 700	8 900	7 800	6 500	66,5	86,5	9 800	8 600	7 600	6 800	44,0	
48,0	61,6	84,9	8 100	7 400	6 800	6 200	63,8	84,4	8 600	8 000	7 300	6 600	48,0	
52,0	58,7	82,5	6 700	6 100	5 600	5 100	60,9	82,0	7 200	6 600	6 100	5 600	52,0	
56,0	55,8	79,9	5 500	5 000	4 600	4 200	58,0	79,3	5 900	5 500	5 000	4 600	56,0	
60,0	52,8	76,9	4 500	4 100	3 700	3 300	54,9	76,3	4 900	4 400	4 100	3 700	60,0	
64,0	49,7	73,6	3 600	3 200	2 900	2 600	51,8	73,0	3 900	3 600	3 200	2 900	64,0	
68,0	46,4	69,9	2 800	2 500	2 200	1 900	48,4	69,2	3 100	2 800	2 500	2 200	68,0	
68,6	45,8	69,3	2 700	2 400	2 100	1 900	47,9	68,6	3 000	2 700	2 400	2 100	68,6	
70,1	44,5	67,7	2 400	2 100	1 900		46,6	67,0	2 700	2 400	2 200	1 900	70,1	
71,6	43,2	66,1	2 200	1 900			45,2	65,4	2 400	2 200	1 900		71,6	
72,0	42,8	65,7	2 100				44,9	65,0	2 400	2 100			72,0	
73,2	41,8	64,4	1 900				43,8	63,7	2 200	1 900			73,2	
74,7							42,4	61,9	1 900				74,7	
76,0													76,0	
76,2													76,2	

MLC250 S-2

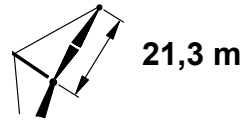
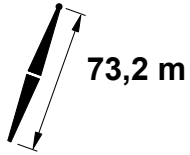
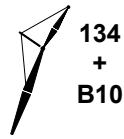

				25°					
				0°	1°	2°	3°		
m	°	m	kg	kg	kg	kg	kg	m	
18,3								18,3	
19,8								19,8	
20,0								20,0	
21,3								21,3	
22,0								22,0	
22,9								22,9	
24,0								24,0	
24,4								24,4	
25,9	80,6	92,2	10 200					25,9	
26,0	80,6	92,2	10 200					26,0	
27,4	79,7	91,8	10 100	8 800				27,4	
28,0	79,3	91,6	10 100	8 800				28,0	
29,0	78,7	91,3	10 000	8 700	7 700			29,0	
30,0	78,0	91,0	10 000	8 700	7 700			30,0	
30,5	77,7	90,8	9 900	8 700	7 700	6 100		30,5	
32,0	76,7	90,3	9 800	8 600	7 600	6 100		32,0	
36,0	74,1	88,9	9 200	8 500	7 600	6 100		36,0	
40,0	71,4	87,2	8 700	8 400	7 500	6 100		40,0	
44,0	68,7	85,2	8 200	8 100	7 400	6 100		44,0	
48,0	65,9	83,1	7 800	7 700	7 300	6 100		48,0	
52,0	63,0	80,6	7 400	7 100	6 500	6 000		52,0	
56,0	60,0	77,9	6 400	5 900	5 400	5 000		56,0	
60,0	56,9	74,9	5 200	4 800	4 400	4 000		60,0	
64,0	53,6	71,5	4 200	3 900	3 500	3 200		64,0	
68,0	50,2	67,7	3 400	3 100	2 800	2 500		68,0	
68,6	49,7	67,0	3 300	3 000	2 700	2 400		68,6	
70,1	48,3	65,4	3 000	2 700	2 400	2 100		70,1	
71,6	46,9	63,7	2 700	2 400	2 100	1 900		71,6	
72,0	46,6	63,3	2 600	2 300	2 100			72,0	
73,2	45,5	61,9	2 400	2 100	1 900			73,2	
74,7	44,0	60,0	2 100	1 900				74,7	
76,0	42,7	58,4	1 900					76,0	
76,2	42,5	58,1	1 900					76,2	

MLC250 S-2

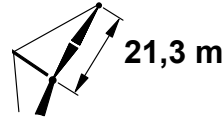
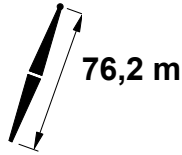
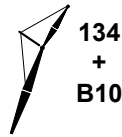

	5°			15°			
	m	°	m	kg	°	m	
19,8	80,2	98,3	12 800				19,8
20,0	80,1	98,3	12 800				20,0
22,0	78,9	97,9	12 600				22,0
22,9	78,3	97,7	12 500	80,6	97,2	11 500	22,9
24,0	77,7	97,5	12 400	79,9	97,0	11 400	24,0
25,9	76,5	97,0	12 200	78,7	96,5	11 200	25,9
26,0	76,4	97,0	12 200	78,6	96,5	11 200	26,0
28,0	75,2	96,4	12 000	77,4	95,9	11 000	28,0
30,0	74,0	95,9	11 700	76,2	95,4	10 900	30,0
32,0	72,8	95,2	11 500	75,0	94,7	10 700	32,0
36,0	70,3	93,8	11 200	72,5	93,3	10 400	36,0
40,0	67,8	92,2	10 800	69,9	91,7	10 100	40,0
44,0	65,2	90,4	9 800	67,3	89,9	9 900	44,0
48,0	62,5	88,4	8 100	64,7	87,8	8 700	48,0
52,0	59,8	86,1	6 700	61,9	85,6	7 200	52,0
56,0	57,0	83,6	5 500	59,1	83,0	6 000	56,0
60,0	54,2	80,8	4 500	56,2	80,2	4 900	60,0
64,0	51,2	77,6	3 600	53,2	77,0	4 000	64,0
68,0	48,1	74,1	2 800	50,1	73,5	3 100	68,0
72,0	44,8	70,2	2 100	46,8	69,5	2 400	72,0
73,2	43,8	69,0	1 900	45,7	68,3	2 200	73,2
74,7				44,4	66,6	1 900	74,7
76,0							76,0
76,2							76,2

MLC250 S-2

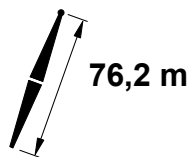

25°				
0°				
m	°	m	kg	m
19,8				19,8
20,0				20,0
22,0				22,0
22,9				22,9
24,0				24,0
25,9	80,9	95,3	10 200	25,9
26,0	80,9	95,3	10 200	26,0
28,0	79,7	94,8	10 100	28,0
30,0	78,4	94,2	10 000	30,0
32,0	77,2	93,5	9 900	32,0
36,0	74,6	92,1	9 400	36,0
40,0	72,0	90,5	8 800	40,0
44,0	69,4	88,6	8 300	44,0
48,0	66,7	86,6	7 900	48,0
52,0	63,9	84,2	7 500	52,0
56,0	61,1	81,6	6 400	56,0
60,0	58,2	78,7	5 300	60,0
64,0	55,1	75,5	4 300	64,0
68,0	51,9	71,9	3 400	68,0
72,0	48,5	67,9	2 600	72,0
73,2	47,4	66,5	2 400	73,2
74,7	46,0	64,8	2 200	74,7
76,0	44,8	63,3	1 900	76,0
76,2	44,6	63,0	1 900	76,2

MLC250 S-2

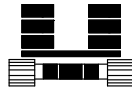
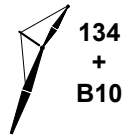

83 730 kg
+
19 960 kg

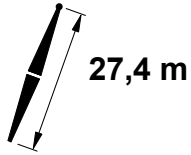

27,4 m



24,4 m

			5°				15°						
 m	 °	 m	 0° kg	 1° kg	 2° kg	 3° kg	 °	 m	 0° kg	 1° kg	 2° kg	 3° kg	 m
12,2	79,5	53,3	11 200	8 500									12,2
13,7	77,8	52,9	11 000	8 500									13,7
14,0	77,5	52,9	11 000	8 400	6 800	5 600							14,0
15,2	76,1	52,6	10 800	8 400	6 700	5 600	80,9	52,2	10 400				15,2
16,0	75,2	52,3	10 700	8 300	6 700	5 500	80,0	52,0	10 300				16,0
16,8	74,3	52,1	10 600	8 300	6 700	5 500	79,1	51,8	10 100	8 400			16,8
18,0	72,9	51,7	10 400	8 300	6 600	5 500	77,7	51,4	9 900	8 400			18,0
18,3	72,5	51,6	10 300	8 300	6 600	5 500	77,3	51,3	9 800	8 300	6 700	5 500	18,3
19,8	70,8	51,1	10 100	8 200	6 600	5 500	75,6	50,8	9 500	8 300	6 700	5 500	19,8
20,0	70,5	51,0	10 100	8 200	6 600	5 500	75,3	50,7	9 500	8 300	6 700	5 500	20,0
21,3	69,0	50,5	9 900	8 100	6 600	5 500	73,8	50,2	9 300	8 100	6 700	5 500	21,3
22,0	68,1	50,2	9 700	8 100	6 600	5 400	72,9	49,9	9 200	8 000	6 700	5 500	22,0
22,9	67,1	49,8	9 600	8 100	6 500	5 400	71,8	49,5	9 000	7 900	6 700	5 500	22,9
24,0	65,7	49,3	9 400	8 000	6 500	5 400	70,5	49,0	8 800	7 800	6 600	5 500	24,0
26,0	63,3	48,3	9 100	7 900	6 500	5 400	68,0	48,0	8 500	7 500	6 600	5 500	26,0
28,0	60,7	47,2	8 800	7 600	6 400	5 400	65,4	46,9	8 200	7 300	6 600	5 500	28,0
30,0	58,1	46,0	8 400	7 400	6 400	5 300	62,8	45,6	8 000	7 100	6 400	5 500	30,0
32,0	55,4	44,6	8 100	7 100	6 300	5 300	60,1	44,2	7 700	6 900	6 200	5 500	32,0
36,0	49,8	41,4	7 500	6 700	6 000	5 300	54,4	41,0	7 200	6 500	5 900	5 400	36,0
40,0	43,6	37,5	7 000	6 300	5 700	5 200	48,2	37,1	6 800	6 200	5 700	5 200	40,0
44,0	36,6	32,6	6 600	6 000	5 400	5 000	41,0	32,1	6 200	5 900	5 400	5 000	44,0
45,7	32,9	29,8	6 400	5 800	5 300	4 900	37,3	29,1	6 000	5 800	5 400	5 000	45,7
48,0	28,0	26,0	6 200	5 700	5 200	4 800	32,3	25,3	5 700	5 600	5 300	4 900	48,0
48,8	25,9	24,2	6 200	5 600	5 200	4 800	30,3	23,7	5 600	5 600	5 200	4 900	48,8
50,3	21,8	20,8	6 100	5 500	5 100	4 700							50,3

MLC250 S-2

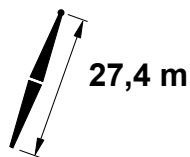

		25°					
		83 730 kg + 19 960 kg					
m	°	m	0° kg	1° kg	2° kg	3° kg	m
12,2							12,2
13,7							13,7
14,0							14,0
15,2							15,2
16,0							16,0
16,8							16,8
18,0							18,0
18,3							18,3
19,8	80,5	49,9	8 800				19,8
20,0	80,3	49,8	8 800				20,0
21,3	78,7	49,3	8 600	7 500	6 700		21,3
22,0	77,9	49,0	8 500	7 500	6 700		22,0
22,9	76,7	48,6	8 400	7 400	6 600	5 600	22,9
24,0	75,4	48,1	8 200	7 300	6 600	5 600	24,0
26,0	72,8	47,0	7 800	7 100	6 400	5 600	26,0
28,0	70,2	45,9	7 300	6 900	6 300	5 600	28,0
30,0	67,6	44,6	6 900	6 700	6 100	5 600	30,0
32,0	64,8	43,2	6 600	6 400	6 000	5 500	32,0
36,0	58,9	39,9	5 900	5 800	5 700	5 300	36,0
40,0	52,5	35,8	5 400	5 400	5 300	5 200	40,0
44,0	45,0	30,6	5 000	5 000	4 900	4 900	44,0
45,7	41,3	27,8	4 900	4 800	4 800	4 800	45,7
48,0							48,0
48,8							48,8
50,3							50,3

MLC250 S-2

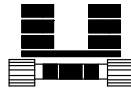
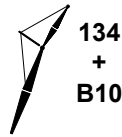

83 730 kg
+
19 960 kg

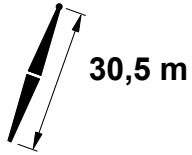

		5°					15°						
			0°	1°	2°	3°			0°	1°	2°	3°	
m	°	m	kg	kg	kg	kg	°	m	kg	kg	kg	kg	m
12,2	80,1	56,4	11 200										12,2
13,7	78,5	56,1	11 100	8 500	6 800								13,7
14,0	78,2	56,0	11 000	8 400	6 700								14,0
15,2	76,9	55,7	10 900	8 400	6 700	5 600							15,2
16,0	76,0	55,5	10 700	8 400	6 700	5 500							16,0
16,8	75,2	55,3	10 600	8 300	6 700	5 500	79,8	55,0	10 200	8 400			16,8
18,0	73,9	54,9	10 400	8 300	6 600	5 500	78,4	54,6	10 000	8 300			18,0
18,3	73,5	54,8	10 400	8 300	6 600	5 500	78,1	54,5	9 900	8 300	6 700		18,3
19,8	71,9	54,3	10 200	8 200	6 600	5 500	76,4	54,0	9 700	8 300	6 700	5 500	19,8
20,0	71,7	54,3	10 100	8 200	6 600	5 500	76,2	53,9	9 600	8 300	6 700	5 500	20,0
21,3	70,2	53,8	9 900	8 100	6 600	5 400	74,7	53,4	9 400	8 200	6 700	5 500	21,3
22,0	69,4	53,5	9 800	8 100	6 600	5 400	73,9	53,2	9 300	8 100	6 700	5 500	22,0
22,9	68,4	53,1	9 700	8 100	6 500	5 400	72,9	52,8	9 200	8 000	6 600	5 500	22,9
24,0	67,2	52,7	9 500	8 100	6 500	5 400	71,7	52,3	9 000	7 900	6 600	5 500	24,0
26,0	64,9	51,8	9 300	8 000	6 500	5 400	69,3	51,4	8 700	7 600	6 600	5 500	26,0
28,0	62,5	50,7	9 000	7 800	6 400	5 400	67,0	50,3	8 400	7 400	6 600	5 500	28,0
30,0	60,1	49,6	8 600	7 600	6 400	5 300	64,5	49,2	8 100	7 200	6 500	5 500	30,0
32,0	57,6	48,3	8 300	7 300	6 300	5 300	62,1	47,9	7 900	7 000	6 300	5 500	32,0
36,0	52,5	45,4	7 800	6 900	6 200	5 300	56,9	45,0	7 400	6 700	6 000	5 500	36,0
40,0	46,9	41,9	7 300	6 500	5 900	5 200	51,2	41,4	7 000	6 300	5 800	5 300	40,0
44,0	40,8	37,6	6 800	6 100	5 600	5 100	45,0	37,1	6 500	6 000	5 600	5 100	44,0
48,0	33,7	32,1	6 400	5 800	5 300	4 900	37,8	31,5	6 000	5 800	5 300	4 900	48,0
48,8	32,0	30,7	6 400	5 800	5 300	4 900	36,1	30,1	5 900	5 800	5 300	4 900	48,8
51,8	25,3	25,0	6 100	5 600	5 100	4 700	29,2	24,3	5 500	5 500	5 200	4 900	51,8
52,0	24,9	24,7	6 100	5 600	5 100	4 700							52,0
53,3	21,1	21,4	6 000	5 500	5 100	4 700							53,3

MLC250 S-2

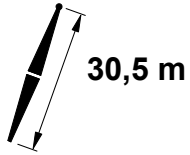
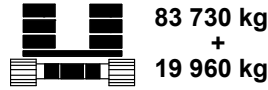
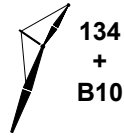

		25°					
		0°	1°	2°	3°		
		kg	kg	kg	kg		
		m	°	m			m
12,2							12,2
13,7							13,7
14,0							14,0
15,2							15,2
16,0							16,0
16,8							16,8
18,0							18,0
18,3							18,3
19,8							19,8
20,0							20,0
21,3	79,4	52,5	8 600	7 600			21,3
22,0	78,6	52,2	8 600	7 500			22,0
22,9	77,6	51,9	8 400	7 500	6 700	5 500	22,9
24,0	76,3	51,4	8 300	7 400	6 600	5 500	24,0
26,0	73,9	50,4	8 000	7 200	6 500	5 500	26,0
28,0	71,5	49,4	7 500	7 000	6 300	5 500	28,0
30,0	69,0	48,2	7 100	6 800	6 200	5 500	30,0
32,0	66,5	46,9	6 800	6 600	6 100	5 500	32,0
36,0	61,1	43,9	6 100	6 000	5 900	5 400	36,0
40,0	55,4	40,2	5 600	5 600	5 500	5 200	40,0
44,0	48,9	35,7	5 200	5 200	5 100	5 100	44,0
48,0	41,3	29,9	4 900	4 800	4 800	4 800	48,0
48,8	39,7	28,5	4 800	4 800	4 800	4 700	48,8
51,8							51,8
52,0							52,0
53,3							53,3

MLC250 S-2



83 730 kg
+
19 960 kg

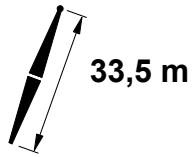

			5°				15°						
			0°	1°	2°	3°			0°	1°	2°	3°	
m	°	m	kg	kg	kg	kg	°	m	kg	kg	kg	kg	m
12,2	80,6	59,5	11 200	8 400									12,2
13,7	79,1	59,2	11 100	8 400									13,7
14,0	78,8	59,1	11 000	8 400									14,0
15,2	77,6	58,8	10 900	8 400	6 700	5 500							15,2
16,0	76,8	58,7	10 800	8 300	6 700	5 500							16,0
16,8	76,0	58,4	10 600	8 300	6 700	5 500	80,3	58,1	10 300				16,8
18,0	74,7	58,1	10 500	8 300	6 600	5 500	79,0	57,8	10 100				18,0
18,3	74,4	58,0	10 400	8 200	6 600	5 500	78,7	57,7	10 000	8 300	6 600		18,3
19,8	72,9	57,5	10 200	8 200	6 600	5 500	77,2	57,2	9 800	8 300	6 600	5 500	19,8
20,0	72,7	57,5	10 200	8 200	6 600	5 500	77,0	57,1	9 800	8 300	6 600	5 500	20,0
21,3	71,3	57,0	10 000	8 100	6 600	5 400	75,6	56,7	9 500	8 200	6 600	5 500	21,3
22,0	70,6	56,8	9 900	8 100	6 500	5 400	74,8	56,4	9 400	8 200	6 600	5 500	22,0
22,9	69,6	56,4	9 800	8 100	6 500	5 400	73,9	56,1	9 300	8 100	6 600	5 500	22,9
24,0	68,4	56,0	9 600	8 000	6 500	5 400	72,7	55,6	9 100	8 000	6 600	5 500	24,0
24,4	68,0	55,8	9 600	8 000	6 500	5 400	72,3	55,5	9 100	7 900	6 600	5 500	24,4
26,0	66,3	55,1	9 400	8 000	6 500	5 400	70,5	54,8	8 900	7 800	6 600	5 500	26,0
28,0	64,1	54,2	9 100	7 900	6 400	5 300	68,3	53,8	8 600	7 500	6 600	5 500	28,0
30,0	61,8	53,1	8 800	7 700	6 400	5 300	66,1	52,7	8 300	7 300	6 600	5 500	30,0
32,0	59,5	51,9	8 500	7 500	6 300	5 300	63,7	51,5	8 100	7 200	6 400	5 500	32,0
36,0	54,8	49,3	8 000	7 000	6 300	5 200	58,9	48,8	7 600	6 800	6 100	5 500	36,0
40,0	49,7	46,0	7 500	6 700	6 000	5 200	53,8	45,6	7 200	6 500	5 900	5 400	40,0
44,0	44,2	42,2	7 000	6 300	5 700	5 200	48,3	41,7	6 800	6 200	5 700	5 200	44,0
48,0	38,1	37,4	6 600	6 000	5 500	5 000	42,0	36,9	6 200	5 900	5 400	5 000	48,0
50,3	34,0	34,0	6 400	5 800	5 300	4 900	37,8	33,3	6 000	5 800	5 300	4 900	50,3
52,0	30,9	31,4	6 300	5 700	5 300	4 800	34,7	30,7	5 800	5 700	5 300	4 900	52,0
54,9	24,3	25,4	6 100	5 600	5 100	4 700	28,2	24,9	5 500	5 500	5 200	4 800	54,9
56,0	21,6	22,9	6 000	5 500	5 100	4 700							56,0
56,4	20,5	21,9	6 000	5 500	5 100	4 700							56,4

MLC250 S-2

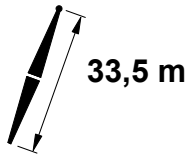

		25°					
		0°	1°	2°	3°		
		kg	kg	kg	kg		
		m	°	m	kg	m	
12,2							12,2
13,7							13,7
14,0							14,0
15,2							15,2
16,0							16,0
16,8							16,8
18,0							18,0
18,3							18,3
19,8							19,8
20,0							20,0
21,3	80,0	55,7	8 700	7 600			21,3
22,0	79,3	55,5	8 600	7 600			22,0
22,9	78,3	55,1	8 500	7 500	6 700		22,9
24,0	77,1	54,7	8 400	7 400	6 600		24,0
24,4	76,6	54,5	8 300	7 400	6 600	5 600	24,4
26,0	74,9	53,8	8 100	7 300	6 500	5 600	26,0
28,0	72,6	52,8	7 800	7 100	6 400	5 600	28,0
30,0	70,3	51,7	7 300	6 900	6 300	5 600	30,0
32,0	67,9	50,5	7 000	6 800	6 200	5 600	32,0
36,0	63,0	47,7	6 400	6 200	5 900	5 400	36,0
40,0	57,8	44,4	5 800	5 700	5 700	5 300	40,0
44,0	52,0	40,4	5 400	5 300	5 300	5 200	44,0
48,0	45,6	35,4	5 000	5 000	5 000	4 900	48,0
50,3	41,3	31,9	4 900	4 800	4 800	4 800	50,3
52,0							52,0
54,9							54,9
56,0							56,0
56,4							56,4

MLC250 S-2

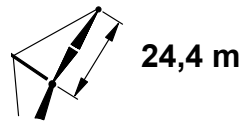
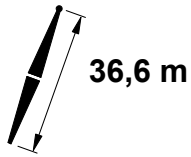

		5°						15°						
			0°	1°	2°	3°			0°	1°	2°	3°		
m	°	m	kg	kg	kg	kg	°	m	kg	kg	kg	kg	m	
13,7	79,7	62,3	11 100	8 400									13,7	
14,0	79,4	62,2	11 000	8 400									14,0	
15,2	78,2	62,0	10 900	8 300	6 700								15,2	
16,0	77,5	61,8	10 800	8 300	6 600								16,0	
16,8	76,7	61,6	10 700	8 300	6 600	5 500	80,8	61,2	10 400				16,8	
18,0	75,5	61,3	10 500	8 200	6 600	5 500	79,6	60,9	10 100				18,0	
18,3	75,2	61,2	10 500	8 200	6 600	5 500	79,3	60,8	10 100	8 300			18,3	
19,8	73,7	60,7	10 300	8 200	6 600	5 400	77,8	60,4	9 900	8 300	6 600	5 500	19,8	
20,0	73,6	60,7	10 200	8 200	6 600	5 400	77,6	60,3	9 800	8 300	6 600	5 500	20,0	
21,3	72,3	60,3	10 100	8 100	6 500	5 400	76,3	59,9	9 600	8 200	6 600	5 500	21,3	
22,0	71,6	60,0	10 000	8 100	6 500	5 400	75,6	59,7	9 500	8 200	6 600	5 500	22,0	
22,9	70,7	59,7	9 800	8 100	6 500	5 400	74,7	59,3	9 400	8 100	6 600	5 500	22,9	
24,0	69,6	59,3	9 700	8 000	6 500	5 400	73,6	58,9	9 200	8 100	6 600	5 500	24,0	
24,4	69,2	59,1	9 600	8 000	6 500	5 400	73,2	58,7	9 200	8 000	6 600	5 500	24,4	
26,0	67,5	58,5	9 400	8 000	6 400	5 400	71,6	58,1	9 000	7 800	6 600	5 500	26,0	
28,0	65,5	57,6	9 200	7 900	6 400	5 300	69,5	57,2	8 700	7 600	6 600	5 500	28,0	
30,0	63,4	56,6	8 900	7 800	6 400	5 300	67,4	56,2	8 400	7 500	6 600	5 400	30,0	
32,0	61,2	55,5	8 700	7 600	6 300	5 300	65,2	55,1	8 200	7 300	6 500	5 400	32,0	
36,0	56,8	53,0	8 200	7 200	6 300	5 200	60,8	52,6	7 800	6 900	6 200	5 400	36,0	
40,0	52,1	50,0	7 700	6 800	6 200	5 200	56,0	49,6	7 300	6 600	6 000	5 400	40,0	
44,0	47,1	46,5	7 300	6 500	5 900	5 200	51,0	46,0	7 000	6 300	5 800	5 300	44,0	
48,0	41,7	42,3	6 800	6 200	5 600	5 100	45,5	41,8	6 500	6 100	5 600	5 100	48,0	
52,0	35,5	37,1	6 500	5 900	5 400	4 900	39,2	36,5	6 000	5 800	5 400	5 000	52,0	
53,3	33,1	34,9	6 400	5 800	5 300	4 900	36,7	34,2	5 900	5 800	5 300	4 900	53,3	
56,0	28,2	30,4	6 200	5 600	5 200	4 800	31,7	29,7	5 700	5 600	5 200	4 900	56,0	
56,4	27,3	29,5	6 200	5 600	5 200	4 700	30,9	28,9	5 600	5 600	5 200	4 800	56,4	
59,4	20,0	22,4	6 000	5 500	5 000	4 700							59,4	

MLC250 S-2

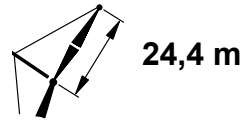
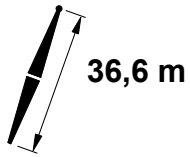

m		25°				m	
		kg					
		0°	1°	2°	3°		
13,7							13,7
14,0							14,0
15,2							15,2
16,0							16,0
16,8							16,8
18,0							18,0
18,3							18,3
19,8							19,8
20,0							20,0
21,3	80,5	58,9	8 800				21,3
22,0	79,8	58,7	8 700				22,0
22,9	78,9	58,3	8 600	7 600	6 700		22,9
24,0	77,8	57,9	8 500	7 500	6 700		24,0
24,4	77,4	57,7	8 400	7 400	6 600	5 500	24,4
26,0	75,7	57,1	8 200	7 300	6 600	5 500	26,0
28,0	73,6	56,1	7 900	7 200	6 400	5 500	28,0
30,0	71,4	55,1	7 500	7 000	6 300	5 500	30,0
32,0	69,2	54,0	7 200	6 900	6 200	5 500	32,0
36,0	64,7	51,4	6 500	6 400	6 000	5 500	36,0
40,0	59,8	48,4	6 000	5 900	5 800	5 300	40,0
44,0	54,6	44,7	5 600	5 500	5 400	5 200	44,0
48,0	48,9	40,3	5 200	5 200	5 100	5 100	48,0
52,0	42,4	34,8	4 900	4 900	4 800	4 800	52,0
53,3	39,9	32,6	4 800	4 800	4 800	4 700	53,3
56,0							56,0
56,4							56,4
59,4							59,4

MLC250 S-2

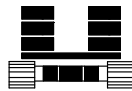

83 730 kg
+
19 960 kg

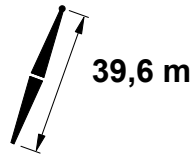

		5°					15°						
			0°	1°	2°	3°			0°	1°	2°	3°	
m	°	m	kg	kg	kg	kg	°	m	kg	kg	kg	kg	m
13,7	80,2	65,4	11 000										13,7
14,0	79,9	65,3	11 000										14,0
15,2	78,8	65,1	10 900	8 300	6 600								15,2
16,0	78,1	64,9	10 800	8 300	6 600								16,0
16,8	77,3	64,7	10 700	8 300	6 600	5 500							16,8
18,0	76,2	64,4	10 500	8 200	6 600	5 500							18,0
18,3	75,9	64,3	10 500	8 200	6 600	5 400	79,9	64,0	10 200	8 300			18,3
19,8	74,5	63,9	10 300	8 200	6 600	5 400	78,4	63,5	9 900	8 200	6 600		19,8
20,0	74,4	63,9	10 200	8 100	6 600	5 400	78,2	63,5	9 900	8 200	6 600		20,0
21,3	73,1	63,5	10 100	8 100	6 500	5 400	77,0	63,1	9 700	8 200	6 600	5 400	21,3
22,0	72,5	63,2	10 000	8 100	6 500	5 400	76,4	62,9	9 600	8 200	6 600	5 400	22,0
22,9	71,6	62,9	9 900	8 100	6 500	5 400	75,5	62,5	9 500	8 200	6 600	5 400	22,9
24,0	70,6	62,5	9 700	8 000	6 500	5 400	74,5	62,2	9 300	8 100	6 600	5 400	24,0
24,4	70,2	62,4	9 700	8 000	6 500	5 400	74,1	62,0	9 300	8 100	6 600	5 400	24,4
25,9	68,8	61,8	9 500	7 900	6 400	5 300	72,6	61,4	9 100	7 900	6 600	5 400	25,9
26,0	68,7	61,8	9 500	7 900	6 400	5 300	72,5	61,4	9 100	7 900	6 600	5 400	26,0
28,0	66,7	60,9	9 200	7 900	6 400	5 300	70,6	60,5	8 800	7 700	6 500	5 400	28,0
30,0	64,7	60,0	9 000	7 800	6 300	5 300	68,6	59,6	8 600	7 500	6 500	5 400	30,0
32,0	62,7	58,9	8 800	7 800	6 300	5 300	66,5	58,5	8 400	7 400	6 500	5 400	32,0
36,0	58,6	56,6	8 300	7 300	6 200	5 200	62,4	56,2	7 900	7 000	6 300	5 400	36,0
40,0	54,2	53,9	7 900	7 000	6 200	5 200	58,0	53,4	7 500	6 700	6 100	5 400	40,0
44,0	49,6	50,6	7 400	6 600	6 000	5 100	53,3	50,2	7 100	6 400	5 800	5 400	44,0
48,0	44,7	46,8	7 000	6 300	5 700	5 100	48,3	46,3	6 800	6 200	5 600	5 200	48,0
52,0	39,2	42,2	6 700	6 000	5 500	5 000	42,8	41,6	6 300	6 000	5 500	5 000	52,0
54,9	34,8	38,2	6 500	5 800	5 300	4 900	38,3	37,5	6 000	5 800	5 400	4 900	54,9
56,0	33,0	36,6	6 400	5 800	5 300	4 800	36,5	35,9	5 900	5 800	5 300	4 900	56,0
59,4	26,6	30,2	6 100	5 600	5 100	4 700	30,0	29,5	5 600	5 500	5 200	4 800	59,4
60,0	25,5	29,2	6 100	5 600	5 100	4 700							60,0
62,5	19,5	22,9	6 000	5 500	5 000	4 600							62,5

MLC250 S-2

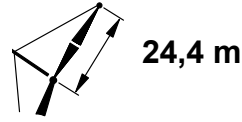
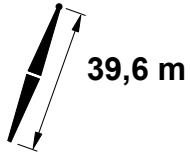
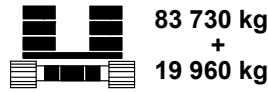
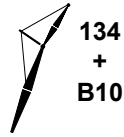

		25°						
	m	°	m	kg	kg	kg	kg	m
13,7								13,7
14,0								14,0
15,2								15,2
16,0								16,0
16,8								16,8
18,0								18,0
18,3								18,3
19,8								19,8
20,0								20,0
21,3								21,3
	81,0	62,1		8 800				
22,0	80,4	61,9		8 700				22,0
22,9	79,5	61,5		8 600	7 600			22,9
24,0	78,4	61,1		8 500	7 500			24,0
24,4	78,0	61,0		8 500	7 500	6 600		24,4
25,9	76,5	60,4		8 300	7 400	6 600	5 500	25,9
26,0	76,5	60,3		8 300	7 400	6 600	5 500	26,0
28,0	74,5	59,5		8 100	7 200	6 500	5 500	28,0
30,0	72,4	58,5		7 700	7 100	6 400	5 500	30,0
32,0	70,4	57,4		7 400	6 900	6 300	5 500	32,0
36,0	66,1	55,0		6 700	6 600	6 100	5 500	36,0
40,0	61,6	52,2		6 200	6 100	5 900	5 400	40,0
44,0	56,9	48,9		5 800	5 700	5 600	5 300	44,0
48,0	51,7	44,9		5 400	5 300	5 300	5 200	48,0
52,0	46,0	40,1		5 100	5 000	5 000	4 900	52,0
54,9	41,3	35,9		4 900	4 800	4 800	4 800	54,9
56,0								56,0
59,4								59,4
60,0								60,0
62,5								62,5

MLC250 S-2

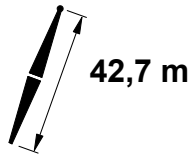

		5°						15°						
			0°	1°	2°	3°			0°	1°	2°	3°		
		m	kg	kg	kg	kg	°	m	kg	kg	kg	kg	m	
13,7	80,6	68,5	11 000										13,7	
14,0	80,4	68,4	11 000										14,0	
15,2	79,3	68,2	10 800	8 300									15,2	
16,0	78,6	68,0	10 800	8 300									16,0	
16,8	77,9	67,9	10 700	8 200	6 600	5 400							16,8	
18,0	76,9	67,6	10 500	8 200	6 600	5 400							18,0	
18,3	76,6	67,5	10 500	8 200	6 600	5 400	80,3	67,1	10 200				18,3	
19,8	75,3	67,1	10 300	8 100	6 500	5 400	79,0	66,7	10 000	8 200	6 600		19,8	
20,0	75,1	67,0	10 300	8 100	6 500	5 400	78,8	66,7	10 000	8 200	6 600		20,0	
21,3	73,9	66,7	10 100	8 100	6 500	5 400	77,6	66,3	9 800	8 200	6 600	5 500	21,3	
22,0	73,3	66,5	10 000	8 100	6 500	5 400	77,0	66,1	9 700	8 200	6 600	5 400	22,0	
22,9	72,5	66,1	9 900	8 000	6 500	5 400	76,2	65,8	9 600	8 200	6 600	5 400	22,9	
24,0	71,5	65,8	9 800	8 000	6 500	5 400	75,2	65,4	9 400	8 100	6 500	5 400	24,0	
24,4	71,1	65,6	9 700	8 000	6 400	5 300	74,8	65,2	9 400	8 100	6 500	5 400	24,4	
25,9	69,8	65,1	9 500	7 900	6 400	5 300	73,5	64,7	9 200	8 000	6 500	5 400	25,9	
26,0	69,7	65,0	9 500	7 900	6 400	5 300	73,4	64,6	9 200	8 000	6 500	5 400	26,0	
28,0	67,8	64,2	9 300	7 900	6 400	5 300	71,5	63,8	8 900	7 800	6 500	5 400	28,0	
30,0	66,0	63,3	9 000	7 800	6 300	5 300	69,6	62,9	8 700	7 600	6 500	5 400	30,0	
32,0	64,1	62,4	8 800	7 800	6 300	5 200	67,7	62,0	8 500	7 500	6 500	5 400	32,0	
36,0	60,2	60,2	8 400	7 500	6 200	5 200	63,8	59,8	8 000	7 100	6 400	5 400	36,0	
40,0	56,1	57,6	8 100	7 100	6 200	5 200	59,7	57,2	7 600	6 800	6 200	5 400	40,0	
44,0	51,9	54,6	7 600	6 700	6 100	5 100	55,4	54,1	7 300	6 600	5 900	5 400	44,0	
48,0	47,3	51,1	7 200	6 400	5 800	5 100	50,8	50,6	7 000	6 300	5 700	5 300	48,0	
52,0	42,4	47,0	6 900	6 200	5 600	5 100	45,8	46,4	6 600	6 100	5 500	5 100	52,0	
56,0	36,9	42,0	6 500	5 900	5 400	4 900	40,3	41,4	6 100	5 900	5 400	5 000	56,0	
57,9	33,9	39,1	6 400	5 800	5 300	4 900	37,2	38,4	5 900	5 800	5 300	4 900	57,9	
60,0	30,6	35,8	6 300	5 700	5 200	4 800	33,9	35,1	5 800	5 700	5 200	4 900	60,0	
62,5	25,8	30,7	6 100	5 600	5 100	4 700	29,2	30,2	5 500	5 500	5 200	4 800	62,5	
64,0	22,8	27,6	6 000	5 500	5 000	4 600							64,0	
65,5	19,0	23,4	5 700	5 400	5 000	4 600							65,5	

MLC250 S-2

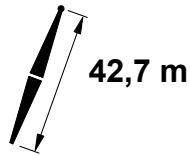
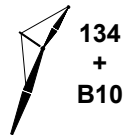

		25°						
			0° 	1° 	2° 	3° 		
	m	°	m	kg	kg	kg	kg	m
13,7								13,7
14,0								14,0
15,2								15,2
16,0								16,0
16,8								16,8
18,0								18,0
18,3								18,3
19,8								19,8
20,0								20,0
21,3								21,3
22,0								22,0
22,9	80,0	64,7	8 700					22,9
24,0	79,0	64,3	8 600					24,0
24,4	78,6	64,2	8 500	7 500	6 600			24,4
25,9	77,2	63,6	8 400	7 400	6 600	5 500		25,9
26,0	77,1	63,6	8 400	7 400	6 600	5 500		26,0
28,0	75,2	62,8	8 200	7 300	6 500	5 500		28,0
30,0	73,3	61,8	7 900	7 100	6 400	5 500		30,0
32,0	71,4	60,9	7 500	7 000	6 300	5 500		32,0
36,0	67,4	58,6	6 900	6 700	6 100	5 500		36,0
40,0	63,2	56,0	6 400	6 300	5 900	5 500		40,0
44,0	58,8	52,9	5 900	5 800	5 700	5 300		44,0
48,0	54,1	49,2	5 500	5 500	5 400	5 200		48,0
52,0	48,9	44,9	5 200	5 200	5 100	5 100		52,0
56,0	43,2	39,6	4 900	4 900	4 900	4 800		56,0
57,9	40,1	36,7	4 800	4 800	4 800	4 700		57,9
60,0								60,0
62,5								62,5
64,0								64,0
65,5								65,5

MLC250 S-2

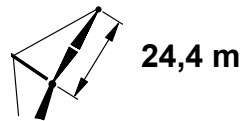
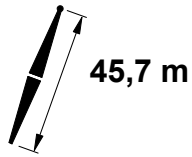

			5°				15°						
			0°	1°	2°	3°			0°	1°	2°	3°	
m	°	m	kg	kg	kg	kg	°	m	kg	kg	kg	kg	m
13,7	81,0	71,6	11 000										13,7
14,0	80,8	71,5	10 900										14,0
15,2	79,8	71,3	10 800	8 200									15,2
16,0	79,1	71,2	10 800	8 200									16,0
16,8	78,4	71,0	10 700	8 200	6 600								16,8
18,0	77,4	70,7	10 500	8 200	6 500								18,0
18,3	77,2	70,6	10 500	8 200	6 500	5 400	80,8	70,3	10 300				18,3
19,8	75,9	70,3	10 300	8 100	6 500	5 400	79,5	69,9	10 100	8 200			19,8
20,0	75,8	70,2	10 300	8 100	6 500	5 400	79,3	69,8	10 000	8 200			20,0
21,3	74,6	69,8	10 100	8 100	6 500	5 400	78,2	69,4	9 900	8 200	6 500		21,3
22,0	74,1	69,6	10 100	8 000	6 500	5 300	77,6	69,2	9 800	8 100	6 500		22,0
22,9	73,3	69,4	9 900	8 000	6 400	5 300	76,8	69,0	9 700	8 100	6 500	5 400	22,9
24,0	72,3	69,0	9 800	8 000	6 400	5 300	75,9	68,6	9 500	8 100	6 500	5 400	24,0
24,4	72,0	68,9	9 800	8 000	6 400	5 300	75,5	68,5	9 500	8 100	6 500	5 400	24,4
25,9	70,7	68,3	9 600	7 900	6 400	5 300	74,2	67,9	9 300	8 100	6 500	5 400	25,9
26,0	70,6	68,3	9 600	7 900	6 400	5 300	74,1	67,9	9 300	8 000	6 500	5 400	26,0
28,0	68,9	67,5	9 300	7 900	6 300	5 300	72,4	67,1	9 000	7 900	6 500	5 400	28,0
30,0	67,1	66,7	9 100	7 800	6 300	5 300	70,6	66,3	8 800	7 700	6 500	5 400	30,0
32,0	65,3	65,8	8 900	7 700	6 300	5 200	68,8	65,4	8 600	7 500	6 500	5 400	32,0
36,0	61,6	63,7	8 500	7 600	6 200	5 200	65,1	63,3	8 200	7 200	6 500	5 400	36,0
40,0	57,8	61,3	8 100	7 200	6 200	5 200	61,2	60,8	7 800	6 900	6 200	5 400	40,0
44,0	53,8	58,5	7 800	6 900	6 100	5 100	57,2	58,0	7 400	6 700	6 000	5 400	44,0
48,0	49,6	55,2	7 400	6 600	5 900	5 100	52,9	54,7	7 100	6 400	5 800	5 300	48,0
52,0	45,1	51,5	7 100	6 300	5 700	5 100	48,4	50,9	6 800	6 200	5 600	5 200	52,0
56,0	40,2	47,0	6 700	6 000	5 500	5 000	43,4	46,4	6 400	6 000	5 500	5 000	56,0
59,4	35,5	42,4	6 500	5 800	5 300	4 900	38,6	41,7	6 000	5 800	5 300	4 900	59,4
60,0	34,7	41,6	6 400	5 800	5 300	4 900	37,9	40,9	6 000	5 800	5 300	4 900	60,0
64,0	28,3	34,9	5 700	5 500	5 100	4 700	31,3	34,0	5 600	5 600	5 200	4 900	64,0
65,5	25,1	31,3	5 400	5 200	4 900	4 600	28,4	30,8	5 500	5 400	5 200	4 800	65,5
68,0	20,0	25,6	4 900	4 800	4 600	4 500							68,0
68,6	18,6	23,9	4 800	4 700	4 500	4 400							68,6

MLC250 S-2

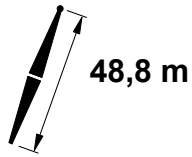

		5°					15°						
			0°	1°	2°	3°			0°	1°	2°	3°	
m	°	m	kg	kg	kg	kg	°	m	kg	kg	kg	kg	m
15,2	80,2	74,4	10 800										15,2
16,0	79,6	74,3	10 700										16,0
16,8	78,9	74,1	10 700	8 200	6 500								16,8
18,0	78,0	73,8	10 600	8 100	6 500								18,0
18,3	77,7	73,8	10 500	8 100	6 500	5 400							18,3
19,8	76,5	73,4	10 300	8 100	6 500	5 400	79,9	73,0	10 100	8 100			19,8
20,0	76,4	73,4	10 300	8 100	6 500	5 400	79,8	73,0	10 100	8 100			20,0
21,3	75,3	73,0	10 200	8 000	6 400	5 300	78,7	72,6	9 900	8 100	6 500		21,3
22,0	74,7	72,8	10 100	8 000	6 400	5 300	78,1	72,4	9 800	8 100	6 500		22,0
22,9	74,0	72,5	10 000	8 000	6 400	5 300	77,4	72,1	9 700	8 100	6 500	5 400	22,9
24,0	73,1	72,2	9 800	8 000	6 400	5 300	76,5	71,8	9 600	8 100	6 500	5 400	24,0
24,4	72,8	72,1	9 800	7 900	6 400	5 300	76,1	71,7	9 500	8 100	6 500	5 400	24,4
25,9	71,5	71,6	9 600	7 900	6 400	5 300	74,9	71,2	9 400	8 000	6 500	5 400	25,9
26,0	71,5	71,5	9 600	7 900	6 400	5 300	74,8	71,1	9 300	8 000	6 500	5 400	26,0
27,4	70,3	71,0	9 400	7 800	6 300	5 300	73,6	70,6	9 200	8 000	6 500	5 400	27,4
28,0	69,8	70,8	9 400	7 800	6 300	5 200	73,1	70,4	9 100	7 900	6 500	5 400	28,0
30,0	68,1	70,0	9 100	7 800	6 300	5 200	71,5	69,6	8 900	7 800	6 500	5 400	30,0
32,0	66,4	69,1	8 900	7 700	6 300	5 200	69,7	68,7	8 700	7 600	6 400	5 400	32,0
36,0	62,9	67,2	8 500	7 600	6 200	5 200	66,2	66,7	8 300	7 300	6 400	5 400	36,0
40,0	59,3	64,9	8 200	7 300	6 100	5 100	62,6	64,4	7 900	7 000	6 300	5 400	40,0
44,0	55,5	62,3	7 800	7 000	6 100	5 100	58,8	61,8	7 500	6 700	6 100	5 400	44,0
48,0	51,6	59,2	7 600	6 700	6 000	5 100	54,8	58,7	7 200	6 500	5 900	5 400	48,0
52,0	47,4	55,7	7 200	6 400	5 800	5 000	50,6	55,2	6 900	6 300	5 700	5 200	52,0
56,0	43,0	51,6	6 900	6 200	5 600	5 000	46,1	51,1	6 600	6 100	5 600	5 100	56,0
60,0	38,1	46,8	6 400	5 900	5 400	4 900	41,1	46,2	6 200	5 900	5 400	5 000	60,0
62,5	34,6	43,2	5 900	5 500	5 200	4 900	37,7	42,5	5 900	5 600	5 300	4 900	62,5
64,0	32,5	41,0	5 500	5 300	5 100	4 800	35,5	40,3	5 700	5 500	5 300	4 900	64,0
67,1	27,5	35,4	4 900	4 700	4 500	4 300	30,5	34,7	5 100	4 900	4 700	4 500	67,1
68,0	26,0	33,7	4 700	4 500	4 400	4 200							68,0
71,6	18,1	24,3	4 100	3 900	3 800	3 700							71,6

MLC250 S-2

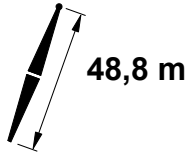
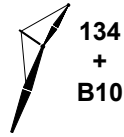

		25°					
		0°	1°	2°	3°		
		kg	kg	kg	kg		
		m	°	m	kg		
15,2							15,2
16,0							16,0
16,8							16,8
18,0							18,0
18,3							18,3
19,8							19,8
20,0							20,0
21,3							21,3
22,0							22,0
22,9	80,9	71,1	8 800				22,9
24,0	80,0	70,7	8 700				24,0
24,4	79,6	70,6	8 600	7 600			24,4
25,9	78,4	70,1	8 500	7 500	6 600		25,9
26,0	78,3	70,0	8 500	7 500	6 600		26,0
27,4	77,1	69,5	8 300	7 400	6 600	5 500	27,4
28,0	76,6	69,3	8 300	7 300	6 600	5 500	28,0
30,0	74,9	68,5	8 100	7 200	6 500	5 500	30,0
32,0	73,1	67,6	7 800	7 100	6 400	5 500	32,0
36,0	69,5	65,6	7 200	6 900	6 200	5 500	36,0
40,0	65,8	63,2	6 700	6 600	6 000	5 500	40,0
44,0	62,0	60,5	6 200	6 100	5 900	5 400	44,0
48,0	57,9	57,4	5 800	5 800	5 700	5 300	48,0
52,0	53,6	53,7	5 500	5 400	5 400	5 200	52,0
56,0	48,9	49,5	5 200	5 200	5 100	5 100	56,0
60,0	43,8	44,4	5 000	4 900	4 900	4 900	60,0
62,5	40,2	40,8	4 800	4 800	4 800	4 700	62,5
64,0							64,0
67,1							67,1
68,0							68,0
71,6							71,6

MLC250 S-2

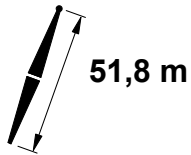

			5°				15°						
			0°	1°	2°	3°			0°	1°	2°	3°	
m	°	m	kg	kg	kg	kg	°	m	kg	kg	kg	kg	m
15,2	80,6	77,5	10 700										15,2
16,0	80,0	77,4	10 700										16,0
16,8	79,4	77,2	10 600	8 100									16,8
18,0	78,5	77,0	10 500	8 100									18,0
18,3	78,2	76,9	10 500	8 100	6 500								18,3
19,8	77,1	76,5	10 300	8 000	6 400	5 300	80,3	76,1	10 200				19,8
20,0	76,9	76,5	10 300	8 000	6 400	5 300	80,2	76,1	10 100				20,0
21,3	75,9	76,2	10 200	8 000	6 400	5 300	79,2	75,7	10 000	8 000			21,3
22,0	75,4	76,0	10 100	8 000	6 400	5 300	78,6	75,6	9 900	8 000			22,0
22,9	74,7	75,7	10 000	7 900	6 400	5 300	77,9	75,3	9 800	8 000	6 500	5 300	22,9
24,0	73,8	75,4	9 800	7 900	6 300	5 300	77,1	75,0	9 600	8 000	6 400	5 300	24,0
24,4	73,5	75,3	9 800	7 900	6 300	5 300	76,7	74,9	9 600	8 000	6 400	5 300	24,4
25,9	72,3	74,8	9 600	7 800	6 300	5 200	75,5	74,4	9 400	8 000	6 400	5 300	25,9
26,0	72,2	74,8	9 600	7 800	6 300	5 200	75,5	74,3	9 400	8 000	6 400	5 300	26,0
27,4	71,1	74,3	9 400	7 800	6 300	5 200	74,3	73,8	9 300	8 000	6 400	5 300	27,4
28,0	70,6	74,1	9 400	7 800	6 300	5 200	73,9	73,6	9 200	8 000	6 400	5 300	28,0
30,0	69,0	73,3	9 200	7 800	6 300	5 200	72,2	72,9	9 000	7 800	6 400	5 300	30,0
32,0	67,4	72,5	8 900	7 700	6 200	5 200	70,6	72,0	8 800	7 700	6 400	5 300	32,0
36,0	64,1	70,6	8 500	7 600	6 200	5 100	67,3	70,2	8 400	7 400	6 400	5 300	36,0
40,0	60,7	68,4	8 200	7 400	6 100	5 100	63,8	68,0	8 000	7 100	6 400	5 300	40,0
44,0	57,1	66,0	7 800	7 100	6 000	5 100	60,3	65,5	7 600	6 800	6 100	5 300	44,0
48,0	53,4	63,1	7 600	6 800	6 000	5 000	56,5	62,6	7 300	6 600	5 900	5 300	48,0
52,0	49,5	59,8	7 300	6 500	5 900	5 000	52,6	59,3	7 100	6 300	5 800	5 300	52,0
56,0	45,4	56,1	7 000	6 300	5 700	5 000	48,4	55,5	6 800	6 100	5 600	5 200	56,0
60,0	41,0	51,7	6 200	5 900	5 500	5 000	43,9	51,1	6 400	6 000	5 500	5 000	60,0
64,0	36,0	46,5	5 300	5 000	4 800	4 600	39,0	45,8	5 500	5 300	5 000	4 800	64,0
65,5	33,9	44,1	5 000	4 800	4 500	4 300	36,8	43,4	5 200	5 000	4 700	4 500	65,5
68,0	30,4	40,3	4 500	4 300	4 100	3 900	33,3	39,5	4 700	4 500	4 300	4 100	68,0
70,1	26,9	36,0	4 100	4 000	3 800	3 600	29,8	35,4	4 300	4 100	3 900	3 700	70,1
72,0	23,7	32,2	3 800	3 600	3 500	3 300							72,0
74,7	17,8	24,8	3 400	3 200	3 100	3 000							74,7

MLC250 S-2

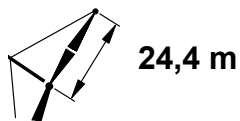
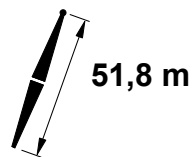

				25°					
				0°	1°	2°	3°		
				kg	kg	kg	kg		
m		°						m	
15,2								15,2	
16,0								16,0	
16,8								16,8	
18,0								18,0	
18,3								18,3	
19,8								19,8	
20,0								20,0	
21,3								21,3	
22,0								22,0	
22,9								22,9	
24,0								24,0	
24,4	80,1	73,8		8 700				24,4	
25,9	78,9	73,3		8 500	7 500	6 500		25,9	
26,0	78,8	73,2		8 500	7 500	6 500		26,0	
27,4	77,6	72,7		8 400	7 400	6 500	5 400	27,4	
28,0	77,2	72,5		8 300	7 400	6 500	5 400	28,0	
30,0	75,5	71,7		8 200	7 300	6 500	5 400	30,0	
32,0	73,8	70,9		8 000	7 100	6 400	5 400	32,0	
36,0	70,4	69,0		7 400	6 900	6 300	5 400	36,0	
40,0	66,9	66,8		6 800	6 700	6 100	5 400	40,0	
44,0	63,3	64,2		6 400	6 300	5 900	5 400	44,0	
48,0	59,5	61,3		6 000	5 900	5 800	5 300	48,0	
52,0	55,5	57,9		5 600	5 600	5 500	5 200	52,0	
56,0	51,2	54,0		5 300	5 300	5 200	5 100	56,0	
60,0	46,6	49,4		5 100	5 000	5 000	5 000	60,0	
64,0	41,4	44,0		4 900	4 800	4 800	4 800	64,0	
65,5	39,2	41,6		4 800	4 800	4 700	4 700	65,5	
68,0								68,0	
70,1								70,1	
72,0								72,0	
74,7								74,7	

MLC250 S-2

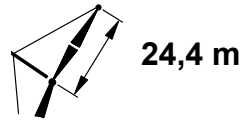
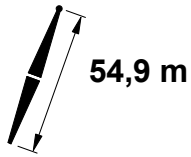
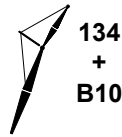

		5°						15°						
			0°	1°	2°	3°			0°	1°	2°	3°		
m	°	m	kg	kg	kg	kg	°	m	kg	kg	kg	kg	m	
15,2	80,9	80,6	10 700										15,2	
16,0	80,4	80,5	10 700										16,0	
16,8	79,8	80,3	10 600	8 100									16,8	
18,0	78,9	80,1	10 500	8 000									18,0	
18,3	78,7	80,0	10 500	8 000	6 400								18,3	
19,8	77,6	79,7	10 300	8 000	6 400	5 300	80,7	79,3	10 200				19,8	
20,0	77,4	79,6	10 300	8 000	6 400	5 300	80,6	79,2	10 100				20,0	
21,3	76,5	79,3	10 200	7 900	6 400	5 300	79,6	78,9	10 000	8 000			21,3	
22,0	75,9	79,1	10 100	7 900	6 400	5 300	79,1	78,7	9 900	8 000			22,0	
22,9	75,3	78,9	10 000	7 900	6 300	5 200	78,4	78,5	9 800	8 000	6 400		22,9	
24,0	74,4	78,6	9 900	7 900	6 300	5 200	77,6	78,2	9 700	8 000	6 400		24,0	
24,4	74,1	78,5	9 800	7 900	6 300	5 200	77,3	78,0	9 600	8 000	6 400	5 300	24,4	
25,9	73,0	78,0	9 600	7 800	6 300	5 200	76,1	77,6	9 500	8 000	6 400	5 300	25,9	
26,0	72,9	78,0	9 600	7 800	6 300	5 200	76,0	77,5	9 500	8 000	6 400	5 300	26,0	
27,4	71,9	77,5	9 500	7 800	6 300	5 200	75,0	77,1	9 300	8 000	6 400	5 300	27,4	
28,0	71,4	77,3	9 400	7 800	6 200	5 200	74,5	76,9	9 200	8 000	6 400	5 300	28,0	
29,0	70,6	76,9	9 300	7 700	6 200	5 200	73,7	76,5	9 100	7 900	6 400	5 300	29,0	
30,0	69,9	76,6	9 200	7 700	6 200	5 200	73,0	76,1	9 000	7 900	6 400	5 300	30,0	
32,0	68,3	75,8	9 000	7 600	6 200	5 200	71,4	75,3	8 800	7 700	6 400	5 300	32,0	
36,0	65,1	74,0	8 600	7 600	6 100	5 100	68,2	73,5	8 500	7 400	6 400	5 300	36,0	
40,0	61,9	71,9	8 200	7 500	6 100	5 100	64,9	71,5	8 100	7 100	6 400	5 300	40,0	
44,0	58,5	69,6	7 900	7 200	6 000	5 100	61,6	69,1	7 800	6 900	6 200	5 300	44,0	
48,0	55,1	66,9	7 600	6 900	6 000	5 000	58,1	66,4	7 500	6 700	6 000	5 300	48,0	
52,0	51,4	63,8	7 300	6 600	5 900	5 000	54,4	63,3	7 200	6 500	5 800	5 300	52,0	
56,0	47,6	60,3	6 900	6 400	5 800	5 000	50,5	59,8	6 900	6 200	5 700	5 200	56,0	
60,0	43,5	56,3	6 000	5 700	5 400	4 900	46,4	55,7	6 300	6 000	5 500	5 100	60,0	
64,0	39,0	51,6	5 100	4 800	4 600	4 300	41,9	51,0	5 300	5 100	4 800	4 600	64,0	
67,1	35,2	47,4	4 500	4 300	4 000	3 800	38,0	46,7	4 700	4 500	4 300	4 000	67,1	
68,0	34,1	46,1	4 300	4 100	3 900	3 700	36,8	45,3	4 500	4 300	4 100	3 900	68,0	
72,0	28,4	39,3	3 600	3 400	3 300	3 100	31,0	38,4	3 800	3 600	3 400	3 200	72,0	
73,2	26,3	36,7	3 400	3 300	3 100	2 900	29,1	36,1	3 600	3 400	3 200	3 100	73,2	
76,0	21,3	30,4	3 000	2 800	2 700	2 600							76,0	
77,7	17,4	25,3	2 700	2 600	2 500	2 300							77,7	

MLC250 S-2

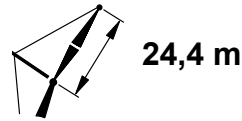
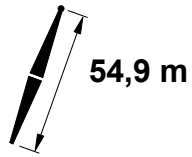
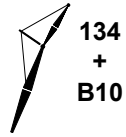

		25°					
		83 730 kg + 19 960 kg					
m	°	m	0° kg	1° kg	2° kg	3° kg	m
15,2							15,2
16,0							16,0
16,8							16,8
18,0							18,0
18,3							18,3
19,8							19,8
20,0							20,0
21,3							21,3
22,0							22,0
22,9							22,9
24,0							24,0
24,4	80,5	76,9	8 700				24,4
25,9	79,3	76,4	8 600	7 500			25,9
26,0	79,2	76,4	8 500	7 500			26,0
27,4	78,1	75,9	8 400	7 400	6 500		27,4
28,0	77,7	75,7	8 400	7 400	6 500		28,0
29,0	76,9	75,4	8 300	7 300	6 500	5 400	29,0
30,0	76,1	75,0	8 200	7 300	6 500	5 400	30,0
32,0	74,5	74,2	8 100	7 200	6 400	5 400	32,0
36,0	71,3	72,4	7 500	7 000	6 300	5 400	36,0
40,0	68,0	70,3	7 000	6 800	6 100	5 400	40,0
44,0	64,5	67,8	6 500	6 400	6 000	5 400	44,0
48,0	60,9	65,1	6 100	6 000	5 800	5 400	48,0
52,0	57,2	61,9	5 800	5 700	5 600	5 300	52,0
56,0	53,2	58,3	5 500	5 400	5 300	5 200	56,0
60,0	48,9	54,1	5 200	5 200	5 100	5 100	60,0
64,0	44,3	49,2	5 000	4 900	4 900	4 800	64,0
67,1	40,3	44,8	4 800	4 700	4 400	4 200	67,1
68,0							68,0
72,0							72,0
73,2							73,2
76,0							76,0
77,7							77,7

MLC250 S-2

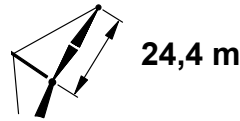
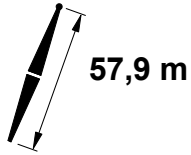
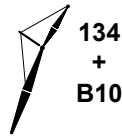

		5°						15°						
			0°	1°	2°	3°			0°	1°	2°	3°		
m	°	m	kg	kg	kg	kg	°	m	kg	kg	kg	kg	m	
16,8	80,2	83,4	10 500										16,8	
18,0	79,3	83,2	10 400										18,0	
18,3	79,1	83,1	10 400	8 000									18,3	
19,8	78,0	82,8	10 400	7 900	6 400								19,8	
20,0	77,9	82,8	10 400	7 900	6 400								20,0	
21,3	77,0	82,4	10 200	7 900	6 300	5 200	80,0	82,0	10 000	8 000			21,3	
22,0	76,5	82,3	10 100	7 900	6 300	5 200	79,5	81,9	10 000	8 000			22,0	
22,9	75,8	82,0	10 000	7 900	6 300	5 200	78,8	81,6	9 900	7 900	6 400		22,9	
24,0	75,0	81,8	9 900	7 800	6 300	5 200	78,1	81,3	9 700	7 900	6 400		24,0	
24,4	74,7	81,6	9 800	7 800	6 300	5 200	77,8	81,2	9 700	7 900	6 400	5 300	24,4	
25,9	73,7	81,2	9 700	7 800	6 200	5 200	76,7	80,8	9 500	7 900	6 400	5 300	25,9	
26,0	73,6	81,2	9 600	7 800	6 200	5 200	76,6	80,7	9 500	7 900	6 400	5 300	26,0	
27,4	72,6	80,7	9 500	7 700	6 200	5 200	75,6	80,3	9 400	7 900	6 400	5 300	27,4	
28,0	72,1	80,5	9 400	7 700	6 200	5 200	75,1	80,1	9 300	7 900	6 300	5 300	28,0	
29,0	71,4	80,2	9 300	7 700	6 200	5 200	74,4	79,7	9 200	7 900	6 300	5 300	29,0	
30,0	70,6	79,8	9 200	7 700	6 200	5 200	73,6	79,4	9 100	7 900	6 300	5 300	30,0	
32,0	69,2	79,1	9 000	7 600	6 200	5 100	72,1	78,6	8 900	7 800	6 300	5 300	32,0	
36,0	66,1	77,4	8 600	7 500	6 100	5 100	69,1	76,9	8 600	7 500	6 300	5 300	36,0	
40,0	63,0	75,4	8 300	7 400	6 100	5 100	66,0	74,9	8 200	7 200	6 300	5 300	40,0	
44,0	59,8	73,2	7 900	7 300	6 000	5 000	62,8	72,7	7 900	7 000	6 300	5 300	44,0	
48,0	56,5	70,6	7 600	7 000	5 900	5 000	59,4	70,1	7 600	6 700	6 100	5 300	48,0	
52,0	53,1	67,7	7 400	6 700	5 900	5 000	56,0	67,2	7 300	6 500	5 900	5 300	52,0	
56,0	49,5	64,4	6 700	6 300	5 800	4 900	52,3	63,9	7 000	6 300	5 700	5 200	56,0	
60,0	45,7	60,7	5 700	5 400	5 100	4 700	48,5	60,1	6 000	5 700	5 400	5 000	60,0	
64,0	41,6	56,4	4 800	4 500	4 300	4 000	44,4	55,8	5 100	4 800	4 500	4 300	64,0	
68,0	37,1	51,4	4 000	3 800	3 600	3 300	39,8	50,7	4 300	4 000	3 800	3 600	68,0	
70,1	34,5	48,3	3 700	3 500	3 200	3 000	37,2	47,5	3 900	3 700	3 400	3 200	70,1	
72,0	32,2	45,5	3 300	3 100	2 900	2 800	34,8	44,7	3 500	3 300	3 100	2 900	72,0	
76,0	26,3	38,1	2 700	2 500	2 400	2 200	28,8	37,2	2 900	2 700	2 500	2 400	76,0	
76,2	26,0	37,6	2 700	2 500	2 400	2 200	28,5	36,7	2 800	2 700	2 500	2 300	76,2	
79,3	20,5	30,4	2 200	2 100	2 000	1 800							79,3	

MLC250 S-2

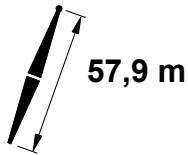

		25°					
		83 730 kg + 19 960 kg					
m	°	m	0° kg	1° kg	2° kg	3° kg	m
16,8							16,8
18,0							18,0
18,3							18,3
19,8							19,8
20,0							20,0
21,3							21,3
22,0							22,0
22,9							22,9
24,0							24,0
24,4	80,9	80,1	8 700				24,4
25,9	79,7	79,6	8 600	7 500			25,9
26,0	79,7	79,6	8 600	7 500			26,0
27,4	78,6	79,1	8 500	7 400	6 500		27,4
28,0	78,2	78,9	8 400	7 400	6 500		28,0
29,0	77,4	78,6	8 300	7 400	6 500	5 400	29,0
30,0	76,7	78,2	8 300	7 300	6 500	5 400	30,0
32,0	75,2	77,4	8 100	7 200	6 400	5 400	32,0
36,0	72,1	75,7	7 600	7 000	6 300	5 400	36,0
40,0	68,9	73,7	7 100	6 800	6 200	5 400	40,0
44,0	65,6	71,4	6 700	6 500	6 000	5 400	44,0
48,0	62,2	68,8	6 300	6 200	5 900	5 400	48,0
52,0	58,7	65,8	5 900	5 800	5 700	5 300	52,0
56,0	55,0	62,4	5 600	5 500	5 500	5 200	56,0
60,0	51,0	58,6	5 300	5 300	5 200	5 100	60,0
64,0	46,8	54,1	5 100	5 100	4 800	4 500	64,0
68,0	42,1	48,8	4 500	4 200	4 000	3 800	68,0
70,1	39,4	45,7	4 100	3 800	3 600	3 400	70,1
72,0							72,0
76,0							76,0
76,2							76,2
79,3							79,3

MLC250 S-2

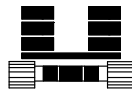

83 730 kg
+
19 960 kg

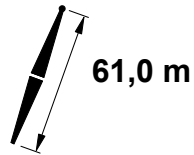

61,0 m



24,4 m

		5°					15°						
			0°	1°	2°	3°			0°	1°	2°	3°	
m	°	m	kg	kg	kg	kg	°	m	kg	kg	kg	kg	m
16,8	80,6	86,5	10 500										16,8
18,0	79,7	86,3	10 400										18,0
18,3	79,5	86,2	10 400	7 900									18,3
19,8	78,5	85,9	10 300	7 900	6 300								19,8
20,0	78,3	85,9	10 200	7 900	6 300								20,0
21,3	77,4	85,6	10 100	7 800	6 300	5 200	80,3	85,2	10 000				21,3
22,0	77,0	85,4	10 100	7 800	6 300	5 200	79,9	85,0	10 000				22,0
22,9	76,3	85,2	10 000	7 800	6 200	5 200	79,3	84,8	9 900	7 900			22,9
24,0	75,6	84,9	9 900	7 800	6 200	5 200	78,5	84,5	9 800	7 900			24,0
24,4	75,3	84,8	9 800	7 800	6 200	5 200	78,2	84,4	9 700	7 900	6 300		24,4
25,9	74,3	84,4	9 700	7 700	6 200	5 100	77,2	83,9	9 500	7 900	6 300	5 200	25,9
26,0	74,2	84,3	9 700	7 700	6 200	5 100	77,1	83,9	9 500	7 900	6 300	5 200	26,0
27,4	73,2	83,9	9 500	7 700	6 200	5 100	76,1	83,5	9 400	7 900	6 300	5 200	27,4
28,0	72,8	83,7	9 400	7 700	6 200	5 100	75,7	83,3	9 400	7 900	6 300	5 200	28,0
29,0	72,1	83,4	9 300	7 700	6 200	5 100	75,0	83,0	9 300	7 900	6 300	5 200	29,0
30,0	71,4	83,1	9 200	7 600	6 100	5 100	74,3	82,6	9 200	7 800	6 300	5 200	30,0
32,0	69,9	82,3	9 000	7 600	6 100	5 100	72,8	81,9	9 000	7 800	6 300	5 200	32,0
36,0	67,0	80,7	8 700	7 500	6 100	5 000	69,9	80,2	8 600	7 500	6 300	5 200	36,0
40,0	64,1	78,8	8 300	7 400	6 000	5 000	66,9	78,4	8 300	7 300	6 300	5 200	40,0
44,0	61,0	76,7	8 000	7 300	6 000	5 000	63,9	76,2	8 000	7 000	6 300	5 200	44,0
48,0	57,9	74,3	7 700	7 100	5 900	5 000	60,7	73,8	7 600	6 800	6 100	5 200	48,0
52,0	54,6	71,5	7 400	6 800	5 900	4 900	57,4	71,0	7 400	6 600	5 900	5 200	52,0
56,0	51,2	68,4	6 500	6 100	5 700	4 900	54,0	67,9	6 900	6 400	5 800	5 200	56,0
60,0	47,7	64,9	5 500	5 100	4 800	4 500	50,4	64,4	5 800	5 500	5 200	4 800	60,0
64,0	43,9	61,0	4 600	4 300	4 000	3 700	46,6	60,3	4 900	4 600	4 300	4 000	64,0
68,0	39,8	56,4	3 800	3 600	3 300	3 100	42,4	55,7	4 100	3 800	3 600	3 300	68,0
71,6	35,7	51,5	3 200	3 000	2 800	2 600	38,3	50,8	3 400	3 200	3 000	2 800	71,6
72,0	35,3	51,1	3 100	2 900	2 700	2 500	37,9	50,3	3 400	3 100	2 900	2 700	72,0
76,0	30,3	44,7	2 500	2 300	2 200	2 000	32,8	43,8	2 700	2 500	2 300	2 100	76,0
77,7	27,7	41,3	2 300	2 100	1 900	1 800	30,2	40,4	2 400	2 200	2 100	1 900	77,7
79,3	25,4	38,2	2 000	1 900			27,9	37,4	2 200	2 000	1 900		79,3
80,0	24,3	36,7	1 900										80,0
80,8	23,0	34,9	1 800										80,8

MLC250 S-2

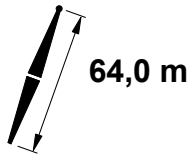

		5°						15°						
			0°	1°	2°	3°			0°	1°	2°	3°		
m	°	m	kg	kg	kg	kg	°	m	kg	kg	kg	kg	m	
16,8	80,9	89,6	10 500										16,8	
18,0	80,1	89,4	10 300										18,0	
18,3	79,9	89,3	10 300	7 900									18,3	
19,8	78,9	89,0	10 200	7 800	6 300								19,8	
20,0	78,8	89,0	10 200	7 800	6 300								20,0	
21,3	77,9	88,7	10 100	7 800	6 200	5 100	80,7	88,3	10 100				21,3	
22,0	77,4	88,6	10 000	7 800	6 200	5 100	80,2	88,1	10 000				22,0	
22,9	76,8	88,3	9 900	7 800	6 200	5 100	79,6	87,9	9 900	7 800			22,9	
24,0	76,1	88,1	9 800	7 700	6 200	5 100	78,9	87,6	9 800	7 800			24,0	
24,4	75,8	88,0	9 800	7 700	6 200	5 100	78,6	87,5	9 700	7 800	6 300		24,4	
25,9	74,8	87,5	9 600	7 700	6 200	5 100	77,6	87,1	9 600	7 800	6 300	5 200	25,9	
26,0	74,7	87,5	9 600	7 700	6 200	5 100	77,6	87,1	9 600	7 800	6 300	5 200	26,0	
27,4	73,8	87,1	9 500	7 600	6 100	5 100	76,6	86,7	9 500	7 800	6 200	5 200	27,4	
28,0	73,4	86,9	9 400	7 600	6 100	5 100	76,2	86,5	9 400	7 800	6 200	5 200	28,0	
29,0	72,7	86,6	9 300	7 600	6 100	5 100	75,5	86,2	9 300	7 800	6 200	5 200	29,0	
30,0	72,0	86,3	9 200	7 600	6 100	5 100	74,8	85,8	9 200	7 800	6 200	5 200	30,0	
30,5	71,7	86,1	9 200	7 600	6 100	5 100	74,5	85,7	9 200	7 800	6 200	5 200	30,5	
32,0	70,7	85,6	9 000	7 500	6 100	5 000	73,4	85,1	9 000	7 800	6 200	5 200	32,0	
36,0	67,9	84,0	8 700	7 400	6 000	5 000	70,6	83,6	8 700	7 600	6 200	5 200	36,0	
40,0	65,0	82,2	8 300	7 400	6 000	5 000	67,8	81,8	8 300	7 300	6 200	5 200	40,0	
44,0	62,1	80,2	8 000	7 300	5 900	5 000	64,9	79,7	8 000	7 100	6 200	5 200	44,0	
48,0	59,1	77,9	7 700	7 200	5 900	4 900	61,8	77,4	7 700	6 900	6 200	5 200	48,0	
52,0	56,0	75,3	7 400	6 900	5 800	4 900	58,7	74,7	7 500	6 700	6 000	5 200	52,0	
56,0	52,8	72,3	6 300	5 800	5 400	4 900	55,5	71,8	6 700	6 300	5 800	5 200	56,0	
60,0	49,5	69,0	5 200	4 900	4 500	4 200	52,1	68,5	5 600	5 300	4 900	4 600	60,0	
64,0	45,9	65,3	4 400	4 100	3 800	3 500	48,5	64,7	4 700	4 400	4 100	3 800	64,0	
68,0	42,1	61,1	3 600	3 300	3 100	2 800	44,7	60,4	3 900	3 600	3 300	3 100	68,0	
72,0	38,1	56,2	2 900	2 700	2 400	2 200	40,6	55,5	3 100	2 900	2 700	2 500	72,0	
74,7	35,0	52,4	2 500	2 300	2 100	1 900	37,5	51,7	2 700	2 500	2 300	2 100	74,7	
76,0	33,6	50,6	2 300	2 100	1 900		36,0	49,8	2 500	2 300	2 100	1 900	76,0	
76,2	33,3	50,2	2 200	2 100	1 900		35,8	49,4	2 400	2 300	2 100	1 900	76,2	
77,7	31,4	47,7	2 000	1 800			33,8	46,8	2 200	2 000	1 800		77,7	
79,3	29,5	45,1	1 800				31,8	44,2	2 000	1 800			79,3	

MLC250 S-2

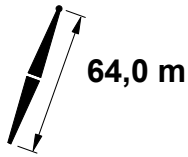
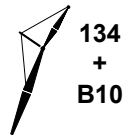

		25°						
		83 730 kg + 19 960 kg						
	m	°	m	0° kg	1° kg	2° kg	3° kg	m
16,8								16,8
18,0								18,0
18,3								18,3
19,8								19,8
20,0								20,0
21,3								21,3
22,0								22,0
22,9								22,9
24,0								24,0
24,4								24,4
25,9	80,5	85,9	8 600					25,9
26,0	80,4	85,9	8 600					26,0
27,4	79,5	85,5	8 500	7 400				27,4
28,0	79,0	85,3	8 500	7 400				28,0
29,0	78,3	85,0	8 400	7 400	6 400			29,0
30,0	77,7	84,6	8 300	7 300	6 400			30,0
30,5	77,3	84,5	8 300	7 300	6 400	5 300		30,5
32,0	76,3	83,9	8 200	7 200	6 400	5 300		32,0
36,0	73,4	82,3	7 900	7 100	6 300	5 300		36,0
40,0	70,5	80,5	7 400	6 900	6 200	5 300		40,0
44,0	67,5	78,4	6 900	6 700	6 100	5 300		44,0
48,0	64,5	76,0	6 500	6 400	5 900	5 300		48,0
52,0	61,3	73,4	6 200	6 100	5 800	5 300		52,0
56,0	58,0	70,4	5 800	5 800	5 700	5 300		56,0
60,0	54,5	67,0	5 600	5 500	5 300	4 900		60,0
64,0	50,9	63,1	5 000	4 700	4 400	4 100		64,0
68,0	46,9	58,7	4 100	3 900	3 600	3 300		68,0
72,0	42,7	53,7	3 400	3 100	2 900	2 700		72,0
74,7	39,6	49,8	2 900	2 700	2 500	2 200		74,7
76,0								76,0
76,2								76,2
77,7								77,7
79,3								79,3

MLC250 S-2

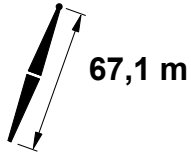
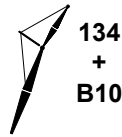

		5°						15°						
			0°	1°	2°	3°			0°	1°	2°	3°		
m	°	m	kg	kg	kg	kg	°	m	kg	kg	kg	kg	m	
18,3	80,2	92,4	10 200										18,3	
19,8	79,3	92,1	10 100	7 700									19,8	
20,0	79,1	92,1	10 100	7 700									20,0	
21,3	78,3	91,8	10 000	7 700	6 200		81,0	91,4	10 100				21,3	
22,0	77,9	91,7	10 000	7 700	6 200		80,6	91,2	10 000				22,0	
22,9	77,3	91,5	9 900	7 700	6 100	5 100	80,0	91,0	9 900				22,9	
24,0	76,6	91,2	9 800	7 700	6 100	5 100	79,3	90,8	9 800				24,0	
24,4	76,3	91,1	9 800	7 700	6 100	5 100	79,0	90,7	9 800	7 800			24,4	
25,9	75,3	90,7	9 600	7 600	6 100	5 000	78,0	90,3	9 600	7 700	6 200		25,9	
26,0	75,3	90,7	9 600	7 600	6 100	5 000	78,0	90,2	9 600	7 700	6 200		26,0	
27,4	74,4	90,3	9 500	7 600	6 100	5 000	77,1	89,8	9 500	7 700	6 200	5 100	27,4	
28,0	74,0	90,1	9 400	7 600	6 100	5 000	76,7	89,7	9 400	7 700	6 200	5 100	28,0	
29,0	73,3	89,8	9 300	7 500	6 000	5 000	76,0	89,4	9 300	7 700	6 200	5 100	29,0	
30,0	72,7	89,5	9 200	7 500	6 000	5 000	75,3	89,0	9 200	7 700	6 200	5 100	30,0	
30,5	72,3	89,3	9 200	7 500	6 000	5 000	75,0	88,9	9 200	7 700	6 200	5 100	30,5	
32,0	71,3	88,8	9 000	7 500	6 000	5 000	74,0	88,4	9 100	7 700	6 200	5 100	32,0	
36,0	68,7	87,3	8 700	7 400	6 000	5 000	71,3	86,8	8 700	7 600	6 200	5 100	36,0	
40,0	65,9	85,6	8 400	7 300	5 900	4 900	68,6	85,1	8 400	7 400	6 200	5 100	40,0	
44,0	63,1	83,6	8 000	7 200	5 900	4 900	65,8	83,1	8 100	7 100	6 200	5 100	44,0	
48,0	60,3	81,4	7 700	7 200	5 800	4 900	62,9	80,9	7 800	6 900	6 200	5 100	48,0	
52,0	57,3	78,9	7 200	6 700	5 800	4 900	59,9	78,4	7 500	6 700	6 000	5 100	52,0	
56,0	54,3	76,2	6 000	5 600	5 200	4 700	56,9	75,6	6 500	6 100	5 600	5 100	56,0	
60,0	51,1	73,0	5 000	4 700	4 300	4 000	53,7	72,5	5 400	5 100	4 700	4 300	60,0	
64,0	47,8	69,5	4 100	3 800	3 500	3 200	50,3	69,0	4 500	4 200	3 900	3 500	64,0	
68,0	44,2	65,6	3 400	3 100	2 800	2 600	46,7	65,0	3 700	3 400	3 100	2 900	68,0	
72,0	40,5	61,1	2 700	2 400	2 200	2 000	42,9	60,4	3 000	2 700	2 500	2 200	72,0	
73,2	39,3	59,6	2 500	2 300	2 000	1 800	41,7	58,9	2 800	2 500	2 300	2 100	73,2	
74,7	37,7	57,7	2 300	2 100	1 800		40,2	56,9	2 500	2 300	2 100	1 900	74,7	
76,0	36,4	56,0	2 100	1 900			38,8	55,2	2 300	2 100	1 900		76,0	
76,2	36,2	55,7	2 000	1 800			38,6	54,9	2 300	2 100	1 800		76,2	
77,7	34,5	53,5	1 800				36,8	52,6	2 000	1 800			77,7	
79,3							35,1	50,3	1 800				79,3	

MLC250 S-2

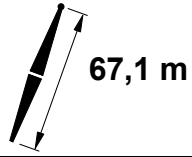
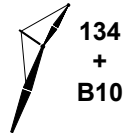

		25°					
			0° 	1° 	2° 	3° 	
m	°	m	kg	kg	kg	kg	m
18,3							18,3
19,8							19,8
20,0							20,0
21,3							21,3
22,0							22,0
22,9							22,9
24,0							24,0
24,4							24,4
25,9	80,8	89,1	8 600				25,9
26,0	80,8	89,1	8 600				26,0
27,4	79,8	88,6	8 500	7 500			27,4
28,0	79,4	88,5	8 500	7 400			28,0
29,0	78,8	88,2	8 400	7 400	6 300		29,0
30,0	78,1	87,8	8 400	7 300	6 300		30,0
30,5	77,8	87,7	8 300	7 300	6 300	5 200	30,5
32,0	76,7	87,2	8 200	7 200	6 300	5 200	32,0
36,0	74,0	85,6	8 000	7 100	6 300	5 200	36,0
40,0	71,2	83,9	7 500	6 900	6 200	5 200	40,0
44,0	68,4	81,9	7 000	6 700	6 100	5 200	44,0
48,0	65,4	79,6	6 600	6 500	5 900	5 200	48,0
52,0	62,4	77,1	6 300	6 200	5 800	5 200	52,0
56,0	59,3	74,2	6 000	5 900	5 700	5 200	56,0
60,0	56,0	71,0	5 700	5 400	5 100	4 700	60,0
64,0	52,6	67,4	4 900	4 500	4 200	3 900	64,0
68,0	48,9	63,3	4 000	3 700	3 400	3 100	68,0
72,0	45,0	58,6	3 200	2 900	2 700	2 500	72,0
73,2	43,8	57,1	3 000	2 800	2 500	2 300	73,2
74,7	42,2	55,0	2 700	2 500	2 300	2 100	74,7
76,0	40,7	53,2	2 500	2 300	2 100	1 900	76,0
76,2	40,5	52,9	2 500	2 200	2 000	1 800	76,2
77,7							77,7
79,3							79,3

MLC250 S-2

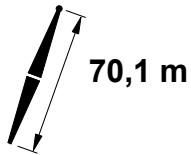

			5°				15°						
			0°	1°	2°	3°			0°	1°	2°	3°	
m	°	m	kg	kg	kg	kg	°	m	kg	kg	kg	kg	m
18,3	80,6	95,5	10 200										18,3
19,8	79,6	95,3	10 100	7 700									19,8
20,0	79,5	95,2	10 100	7 700									20,0
21,3	78,7	95,0	10 000	7 700	6 100								21,3
22,0	78,3	94,8	9 900	7 600	6 100								22,0
22,9	77,7	94,6	9 900	7 600	6 100	5 000	80,4	94,2	9 900				22,9
24,0	77,0	94,4	9 800	7 600	6 100	5 000	79,6	93,9	9 800				24,0
24,4	76,8	94,2	9 700	7 600	6 100	5 000	79,4	93,8	9 800	7 700			24,4
25,9	75,8	93,9	9 600	7 500	6 100	5 000	78,4	93,4	9 600	7 700	6 200		25,9
26,0	75,8	93,8	9 600	7 500	6 100	5 000	78,4	93,4	9 600	7 700	6 200		26,0
27,4	74,9	93,5	9 500	7 500	6 000	5 000	77,5	93,0	9 500	7 700	6 100	5 100	27,4
28,0	74,5	93,3	9 400	7 500	6 000	5 000	77,1	92,8	9 400	7 700	6 100	5 100	28,0
29,0	73,9	93,0	9 300	7 500	6 000	5 000	76,5	92,5	9 400	7 700	6 100	5 100	29,0
30,0	73,2	92,7	9 200	7 500	6 000	5 000	75,8	92,2	9 300	7 700	6 100	5 100	30,0
30,5	72,9	92,5	9 200	7 500	6 000	5 000	75,5	92,1	9 200	7 700	6 100	5 100	30,5
32,0	72,0	92,0	9 000	7 400	6 000	5 000	74,6	91,6	9 100	7 600	6 100	5 100	32,0
36,0	69,4	90,6	8 700	7 300	5 900	4 900	72,0	90,1	8 800	7 600	6 100	5 100	36,0
40,0	66,8	88,9	8 400	7 300	5 900	4 900	69,3	88,5	8 500	7 400	6 100	5 100	40,0
44,0	64,1	87,1	8 000	7 200	5 800	4 900	66,6	86,6	8 200	7 200	6 100	5 100	44,0
48,0	61,3	84,9	7 800	7 100	5 800	4 800	63,9	84,4	7 900	7 000	6 100	5 100	48,0
52,0	58,5	82,6	6 900	6 400	5 700	4 800	61,0	82,0	7 500	6 700	6 100	5 100	52,0
56,0	55,6	79,9	5 800	5 300	4 900	4 500	58,1	79,4	6 300	5 800	5 300	4 900	56,0
60,0	52,6	76,9	4 800	4 400	4 000	3 600	55,1	76,4	5 200	4 800	4 400	4 000	60,0
64,0	49,4	73,6	3 900	3 500	3 200	2 900	51,9	73,1	4 300	3 900	3 600	3 300	64,0
68,0	46,1	69,9	3 100	2 800	2 500	2 300	48,6	69,3	3 400	3 100	2 800	2 600	68,0
70,1	44,3	67,7	2 700	2 500	2 200	1 900	46,7	67,1	3 000	2 800	2 500	2 200	70,1
71,6	42,9	66,1	2 500	2 200	2 000		45,3	65,5	2 800	2 500	2 200	2 000	71,6
72,0	42,6	65,8	2 400	2 200			45,0	65,1	2 700	2 400	2 200	1 900	72,0
73,2	41,6	64,4	2 200	2 000			43,9	63,7	2 500	2 300	2 000	1 800	73,2
74,7	40,1	62,7	2 000				42,5	61,9	2 300	2 000	1 800		74,7
76,0							41,2	60,3	2 000	1 800			76,0
76,2							41,0	60,0	2 000	1 800			76,2
77,7							39,5	58,0	1 800				77,7

MLC250 S-2

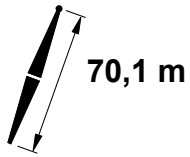

				25°					
				83 730 kg + 19 960 kg					
m	°	m	0° kg	1° kg	2° kg	3° kg	m		
18,3							18,3		
19,8							19,8		
20,0							20,0		
21,3							21,3		
22,0							22,0		
22,9							22,9		
24,0							24,0		
24,4							24,4		
25,9							25,9		
26,0							26,0		
27,4	80,2	91,8	8 600				27,4		
28,0	79,8	91,6	8 500				28,0		
29,0	79,1	91,3	8 500	7 400			29,0		
30,0	78,5	91,0	8 400	7 300			30,0		
30,5	78,2	90,9	8 400	7 300	6 300		30,5		
32,0	77,2	90,4	8 300	7 300	6 300	5 200	32,0		
36,0	74,6	88,9	8 000	7 100	6 300	5 200	36,0		
40,0	71,9	87,2	7 600	6 900	6 200	5 200	40,0		
44,0	69,2	85,3	7 200	6 800	6 100	5 200	44,0		
48,0	66,3	83,1	6 800	6 600	6 000	5 200	48,0		
52,0	63,5	80,7	6 400	6 300	5 900	5 200	52,0		
56,0	60,5	78,0	6 100	6 000	5 700	5 200	56,0		
60,0	57,4	74,9	5 600	5 200	4 800	4 400	60,0		
64,0	54,1	71,5	4 600	4 300	3 900	3 600	64,0		
68,0	50,7	67,7	3 800	3 400	3 100	2 900	68,0		
70,1	48,8	65,4	3 300	3 100	2 800	2 500	70,1		
71,6	47,4	63,8	3 000	2 800	2 500	2 300	71,6		
72,0	47,1	63,4	3 000	2 700	2 400	2 200	72,0		
73,2	46,0	61,9	2 800	2 500	2 300	2 000	73,2		
74,7	44,5	60,1	2 500	2 300	2 000	1 800	74,7		
76,0	43,2	58,4	2 300	2 000	1 800		76,0		
76,2	43,0	58,1	2 200	2 000	1 800		76,2		
77,7	41,4	56,1	2 000				77,7		

MLC250 S-2

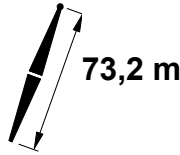
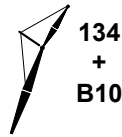

	5°			15°			
	m	°	m	kg	m	°	
18,3	80,9	98,6	10 200				18,3
20,0	79,8	98,3	10 000				20,0
22,0	78,6	97,9	9 900				22,0
22,9	78,1	97,7	9 800	80,7	97,3	9 900	22,9
24,0	77,4	97,5	9 700	80,0	97,0	9 800	24,0
26,0	76,2	97,0	9 700	78,8	96,5	9 600	26,0
27,4	75,4	96,6	9 500	77,9	96,2	9 500	27,4
28,0	75,0	96,5	9 400	77,5	96,0	9 500	28,0
30,0	73,8	95,9	9 200	76,3	95,4	9 300	30,0
32,0	72,5	95,3	9 100	75,1	94,8	9 100	32,0
36,0	70,1	93,9	8 700	72,6	93,4	8 800	36,0
40,0	67,5	92,3	8 400	70,0	91,8	8 500	40,0
44,0	64,9	90,4	8 100	67,4	90,0	8 300	44,0
48,0	62,3	88,4	7 800	64,8	87,9	8 000	48,0
52,0	59,6	86,1	6 700	62,1	85,6	7 300	52,0
56,0	56,8	83,6	5 600	59,3	83,1	6 100	56,0
60,0	54,0	80,8	4 500	56,4	80,2	5 000	60,0
64,0	51,0	77,6	3 600	53,4	77,1	4 100	64,0
68,0	47,8	74,1	2 900	50,2	73,5	3 200	68,0
72,0	44,6	70,2	2 200	46,9	69,6	2 500	72,0
73,2	43,6	69,0	2 000	45,9	68,3	2 300	73,2
76,0				43,4	65,1	1 800	76,0
76,2				43,2	64,9	1 800	76,2
77,7							77,7

MLC250 S-2

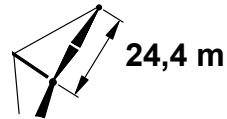
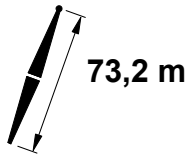

		25°			
				0°	
m	°	m	kg	m	
18,3				18,3	
20,0				20,0	
22,0				22,0	
22,9				22,9	
24,0				24,0	
26,0				26,0	
27,4	80,5	95,0	8 600	27,4	
28,0	80,1	94,8	8 500	28,0	
30,0	78,9	94,2	8 400	30,0	
32,0	77,6	93,6	8 300	32,0	
36,0	75,1	92,1	8 000	36,0	
40,0	72,5	90,5	7 700	40,0	
44,0	69,9	88,7	7 300	44,0	
48,0	67,2	86,6	6 900	48,0	
52,0	64,4	84,3	6 500	52,0	
56,0	61,6	81,7	6 200	56,0	
60,0	58,6	78,8	5 400	60,0	
64,0	55,6	75,6	4 500	64,0	
68,0	52,3	71,9	3 600	68,0	
72,0	48,9	67,9	2 800	72,0	
73,2	47,9	66,6	2 600	73,2	
76,0	45,3	63,3	2 100	76,0	
76,2	45,1	63,1	2 100	76,2	
77,7	43,7	61,2	1 800	77,7	

REFERENCE ONLY!