

# Liftcrane Luffing Jib Capacities

Luffing Jib No. LJ10:681-682 on  
 Boom No. B60:680  
 with Mast No. M10:684 or Mast No. M11:684  
 661,300 lb VPC (Variable Position Counterweight)  
 360 Degree Rating

**MLC650  
 VPC-MAX  
 SERIES 2**



**LIFTING CAPACITIES:** Lifting capacities for various boom lengths, boom angles, luffing jib lengths, and luffing jib operating radii are for freely suspended loads and may be based on percent of static tipping or strength of structural components. Capacities must be reduced by applicable deducts.

Upper luffing jib point capacity for liftcrane service with single part whip line from Drum 3 is 30,000 lb or 60,000 lb with two part whip line. When Drum 1 or Drum 2 is used, capacity with single part whip line is 48,800 lb, or 73,500 lb with two part whip line. In all cases, upper luffing jib point capacities cannot exceed those listed for main luffing jib capacity.

Weight of all load blocks, hooks, weight ball, slings, hoist lines, etc., beneath boom and luffing jib point sheaves is considered part of load. Boom and luffing jib are not to be lowered beyond radii where combined weights are greater than rated capacity. Operation is only approved for boom and luffing jib angle range shown in capacity chart.

**LUFFING JIB BACKWARD STABILITY:** Capacities indicated by (b) require 14,000 lb minimum weight suspended beneath luffing jib point, (c) require 28,000 lb minimum weight, and (d) require 40,000 lb minimum weight. **Caution: Do not luff into areas indicated by (b), (c), or (d) without required minimum weight.** *Luffing jib may not luff down and luffing jib hoist wire rope may go slack. Luffing jib hoist wire rope may overhaul luffing jib and cause wire rope damage or failure.*

**OPERATING CONDITIONS:** Machine to operate on a firm, level, and uniformly supporting surface. Supporting surface and bearing turntable are to be level within a tolerance of 1/2 in. in 10 ft. Refer to Luffing Jib Rigging **No. 81022910**, Mast Rigging **No. 81025005** or **No. 84050187**, Wire Rope Specifications chart **No. 9548-A**, Counterweight Arrangements chart **No. 9349-A**, Luffing Jib Raising Procedure chart **No. 9421-A**, and Wind Conditions chart **No. 9423-A**. Crane operator judgment must be used to allow for dynamic load effects of swinging, hoisting or lowering, travel, wind conditions, as well as adverse operating conditions and physical machine depreciation. Refer to the Operator Manual for operating guidelines.

**MACHINE TRAVEL:** Machine to travel on a firm, level, and uniformly supporting surface. Boom and luffing jib must be within angle range shown in capacity chart. Refer to Maximum Allowable Travel Specifications chart **No. 9422-A**.



**OPERATING RADIUS:** Operating radius is horizontal distance from axis of rotation to center of vertical hoist line or load block. Boom angle and luffing jib angle are an indication of operating radius. In all cases, operating radius shall govern capacity.



**BOOM ANGLE:** Boom angle in degrees (°) is angle between horizontal and centerline of boom butt and inserts.



**LUFFING JIB ANGLE:** Luffing jib angle in degrees (°) is angle between horizontal and centerline of luffing jib butt and inserts.

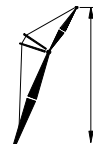

**LUFFING JIB POINT ELEVATION:** Luffing jib point elevation is vertical distance from ground level to centerline of luffing jib point shaft.

**MACHINE EQUIPMENT:** Machine equipped with VPC-MAX, 36 ft 6 in. crawlers, 60 in. or 80 in. treads, 36 ft 1 in. live mast, 118.1 ft mast, 16 part boom hoist reeving, boom support straps, 20 part luffing jib hoist reeving, luffing jib and backstay support straps, and 661,300 lb VPC.

Select counterweight position from Luffing Jib Raising Procedure chart **No. 9421-A** that will allow raising and lowering of boom and luffing jib length. Counterweight position selection may be changed with luffing jib on ground or while luffing jib is within operating range of capacity chart.

**Explanation of Symbols**

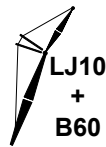

Luffing Jib No. LJ10:681-682  
+  
Boom No. B60:680



VPC (Variable Position Counterweight)



360 Degree Rating



Boom Length



Luffing Jib Length



Boom Angle  
(see page 1)

**Explanation of Symbols**  
(continued)



Operating Radius  
(see page 1)



Luffing Jib Angle  
(see page 1)



Luffing Jib Elevation  
(see page 1)



Counterweight Position  
from Axis of Rotation



Lifting Capacities  
(see page 1)

REFERENCE ONLY!

# MLC650 VPC-MAX S-2

ASME B30.5

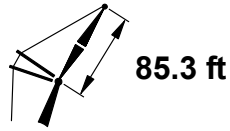
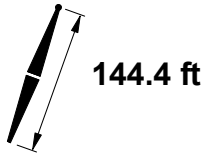

ft	85°				83°				80°				ft
	ft	ft	lb	lb	ft	lb	lb	ft	lb	lb			
50	73.0	234.6	716,600 c	771,600 c									50
55	69.4	232.6	640,700 c	771,600 c									55
60	65.7	230.2	578,500 b	771,600 b	69.4	232.0	565,500 b	771,600 b					60
65	61.8	227.4	526,600 b	771,600 b	65.7	229.6	514,800 b	771,600 b					65
70	57.8	224.1	482,600 b	752,400 b	61.8	226.8	471,800 b	771,600 b	67.5	229.5	455,500 b	764,800 b	70
75	53.6	220.3	444,800	720,300	57.8	223.5	434,800 b	715,500 b	63.8	226.9	419,800 b	703,100 b	75
80	49.1	215.9	412,000	669,500	53.6	219.7	402,700	661,800	59.8	223.9	388,800 b	650,400 b	80
85	44.3	210.7	383,100	622,500	49.1	215.3	374,500	615,300	55.7	220.4	361,600	604,600	85
90	38.9	204.4	357,500	565,600	44.3	210.0	349,600	574,600	51.4	216.3	337,500	564,600	90
95	32.7	196.7	334,600	480,700	38.9	203.8	327,200	538,600	46.7	211.5	316,000	529,300	95
100	25.0	186.3	313,700	400,100	32.7	196.0	307,100	496,700	41.7	205.8	296,700	497,800	100
105	12.7	168.8	294,200	312,000	25.0	185.7	288,700	413,500	35.9	198.8	279,200	469,700	105
110					12.8	168.3	271,200	323,400	29.1	190.0	263,100	444,200	110
115									20.0	177.4	248,100	389,400	115
120													120
125													125
130													130
135													135
140													140
145													145
150													150

# MLC650 VPC-MAX S-2

ASME B30.5

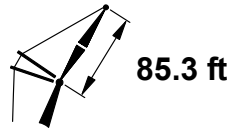
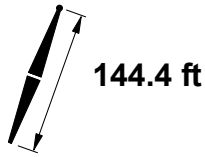
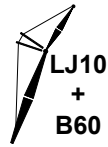

ft	75°				70°				65°				ft
	ft	ft	lb	lb	ft	ft	lb	lb	ft	ft	lb	lb	
50													50
55													55
60													60
65													65
70													70
75													75
80													80
85													85
90	61.7	222.3	317,300	548,300									90
95	57.6	219.0	297,100	514,000									95
100	53.4	215.2	279,000	483,400									100
105	48.9	210.7	262,600	456,100	59.2	216.3	245,900	442,900					105
110	44.0	205.5	247,700	431,500	55.1	212.7	232,000	419,000					110
115	38.6	199.2	234,000	409,200	50.7	208.5	219,200	397,300					115
120	32.4	191.3	221,400	388,800	46.0	203.6	207,500	377,600					120
125	24.6	180.9	209,600	370,100	40.8	197.7	196,700	359,600	52.1	204.8	183,400	349,100	125
130	11.8	162.5	197,900	352,700	35.0	190.6	186,600	343,000	47.5	200.1	174,100	333,100	130
135					28.0	181.4	177,100	327,600	42.5	194.6	165,400	318,200	135
140					18.2	167.7	167,900	313,300	36.9	187.9	157,200	304,500	140
145									30.3	179.5	149,500	291,700	145
150									21.8	167.7	142,000	279,700	150

# MLC650 VPC-MAX S-2

ASME B30.5

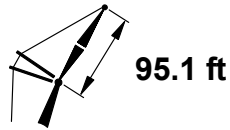
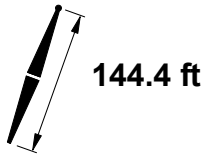

ft	85°				83°				80°				ft
	ft	lb	lb	lb	ft	lb	lb	lb	ft	lb	lb	lb	
50	74.8	245.0	714,200 c	771,600 c									50
55	71.6	243.2	638,400 b	771,600 b									55
60	68.4	241.1	576,300 b	771,600 b	71.7	242.6	563,000 b	771,600 b					60
65	65.0	238.7	524,500 b	763,900 b	68.4	240.5	512,300 b	771,600 b					65
70	61.6	235.9	480,600 b	731,500 b	65.0	238.1	469,400 b	771,300 b					70
75	58.0	232.6	442,900	701,000	61.6	235.2	432,600 b	712,300 b	66.7	238.0	417,100 b	699,800 b	75
80	54.3	228.9	410,100	666,700	58.0	232.0	400,600	658,900	63.3	235.4	386,200	647,200	80
85	50.3	224.7	381,400	619,900	54.3	228.3	372,500	612,600	59.8	232.4	359,200	601,700	85
90	46.1	219.8	356,000	578,900	50.3	224.1	347,700	572,000	56.2	228.9	335,200	561,800	90
95	41.5	214.0	333,300	540,100	46.1	219.2	325,600	536,200	52.3	225.0	313,900	526,700	95
100	36.4	207.2	312,900	502,100	41.5	213.4	305,600	504,400	48.2	220.4	294,700	495,400	100
105	30.6	198.9	294,300	431,700	36.5	206.6	287,600	475,900	43.9	215.1	277,400	467,400	105
110	23.2	187.8	277,300	362,700	30.6	198.3	271,200	446,400	39.1	208.9	261,600	442,200	110
115	11.3	168.5	261,000	284,600	23.3	187.2	255,900	375,200	33.6	201.4	247,100	419,300	115
120					11.3	168.0	241,300	295,300	27.2	191.9	233,700	398,400	120
125									18.4	178.2	221,100	355,300	125
130													130
135													135
140													140
145													145
150													150
155													155
160													160

# MLC650 VPC-MAX S-2

ASME B30.5

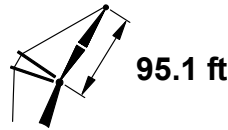
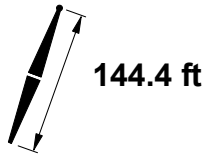
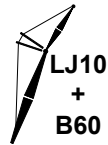

ft	75°				70°				65°				ft
	ft	ft	lb	lb	ft	ft	lb	lb	ft	ft	lb	lb	
50													50
55													55
60													60
65													65
70													70
75													75
80													80
85													85
90	64.9	233.6	314,400	545,200									90
95	61.4	230.8	294,300	511,100									95
100	57.8	227.6	276,300	480,700									100
105	54.1	223.8	260,100	453,500									105
110	50.1	219.5	245,300	429,000	59.3	224.8	229,000	416,200					110
115	45.9	214.6	231,800	406,800	55.6	221.3	216,400	394,600					115
120	41.3	208.8	219,400	386,600	51.7	217.2	204,800	375,000					120
125	36.2	202.0	208,000	368,200	47.6	212.6	194,100	357,100					125
130	30.3	193.5	197,300	351,200	43.2	207.2	184,300	340,700	53.0	213.5	171,200	330,500	130
135	22.9	182.2	187,200	335,400	38.3	200.8	175,100	325,500	48.9	209.0	162,600	315,800	135
140	10.3	162.0	177,100	320,600	32.7	193.0	166,400	311,500	44.6	203.9	154,600	302,200	140
145					26.1	183.1	158,200	298,400	39.9	197.8	147,200	289,500	145
150					16.6	168.3	150,300	286,100	34.6	190.5	140,100	277,800	150
155									28.3	181.4	133,400	266,700	155
160									20.1	168.8	126,900	256,300	160

# MLC650 VPC-MAX S-2

ASME B30.5

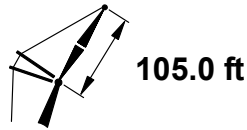
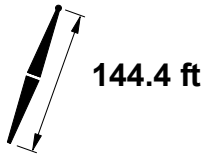

ft	85°				83°				80°				ft
	ft	lb	lb	lb	ft	lb	lb	lb	ft	lb	lb	lb	
55	73.4	253.7	637,200 b	771,600 b									55
60	70.5	251.8	575,100 b	760,400 b									60
65	67.6	249.6	523,400 b	741,000 b									65
70	64.5	247.2	479,600 b	711,200 b	70.5	251.2	511,000 b	766,500 b					70
75	61.4	244.3	441,900	682,600	67.6	249.0	468,200 b	750,700 b	69.1	248.8	415,700	697,300	75
80	58.1	241.1	409,300	655,700	64.5	246.5	431,400	710,000	66.0	246.5	384,900	645,000	80
85	54.8	237.5	380,600	618,100	61.4	243.7	399,500	656,800	63.0	243.9	357,900	599,600	85
90	51.2	233.4	355,300	577,200	58.2	240.5	371,500	610,600	59.8	240.9	334,000	560,000	90
95	47.5	228.7	332,800	541,200	54.8	236.9	346,800	570,300	56.5	237.4	312,800	524,900	95
100	43.5	223.4	312,500	507,700	51.3	232.8	324,800	534,600	53.0	233.6	293,700	493,800	100
105	39.2	217.2	294,200	474,100	47.5	228.1	305,000	502,900	49.4	229.2	276,500	465,900	105
110	34.4	209.9	277,500	441,500	43.5	222.8	287,100	474,600	45.6	224.2	260,900	440,800	110
115	28.7	200.9	262,200	391,100	39.2	216.6	270,900	449,000	41.4	218.5	246,600	418,100	115
120	21.7	189.0	248,000	331,000	34.4	209.3	256,000	425,800	36.8	211.8	233,500	397,400	120
125	9.9	168.0	234,200	259,500	28.8	200.3	242,300	403,900	31.7	203.7	221,300	378,400	125
130					21.7	188.4	229,500	342,800	25.5	193.5	210,000	361,000	130
135					10.0	167.5	217,100	268,500	17.0	178.9	199,200	324,800	135
140													140
145													145
150													150
155													155
160													160
165													165
170													170



# MLC650 VPC-MAX S-2

ASME B30.5

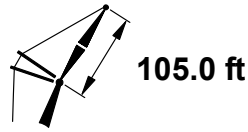
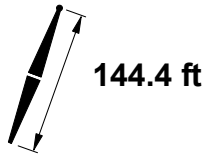
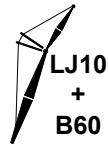

ft	75°				70°				65°				ft
	ft	°	ft	lb	ft	°	ft	lb	ft	°	ft	lb	
55													55
60													60
65													65
70													70
75													75
80													80
85													85
90													90
95	64.4	242.1	292,800	509,100									95
100	61.2	239.3	274,900	478,900									100
105	58.0	236.0	258,700	451,800									105
110	54.6	232.4	244,000	427,400									110
115	51.1	228.3	230,700	405,400	59.3	233.3	214,800	392,900					115
120	47.3	223.6	218,400	385,300	56.0	229.8	203,300	373,400					120
125	43.3	218.2	207,100	366,900	52.5	225.9	192,800	355,600					125
130	39.0	212.0	196,600	350,000	48.8	221.4	183,000	339,300					130
135	34.1	204.6	186,900	334,500	45.0	216.3	174,000	324,200	53.6	222.1	161,100	314,200	135
140	28.5	195.5	177,700	320,100	40.8	210.5	165,500	310,300	50.0	217.8	153,200	300,700	140
145	21.3	183.4	169,000	306,700	36.1	203.6	157,600	297,400	46.2	212.9	145,900	288,200	145
150	8.9	161.3	160,200	293,900	30.8	195.3	150,100	285,300	42.1	207.3	139,000	276,500	150
155					24.4	184.7	143,000	274,000	37.6	200.8	132,500	265,700	155
160					15.3	168.8	136,000	263,300	32.6	193.0	126,300	255,400	160
165									26.6	183.3	120,400	245,800	165
170									18.7	169.7	114,700	236,700	170

# MLC650 VPC-MAX S-2

ASME B30.5



661,300 lb

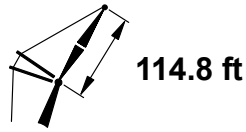
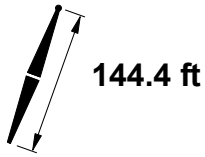

ft	85°				83°				80°				ft
	ft	lb	lb	lb	ft	lb	lb	lb	ft	lb	lb	lb	
55	74.9	264.0	634,800 b	724,500 b									55
60	72.3	262.3	572,800 b	710,200 b									60
65	69.6	260.4	521,000 b	695,400 b	72.3	261.7	508,400 b	714,400 b					65
70	66.9	258.2	477,300	680,600	69.6	259.8	465,700	701,700					70
75	64.1	255.6	439,700	663,300	66.9	257.5	428,900	688,600					75
80	61.2	252.8	407,100	638,100	64.1	255.0	397,100	653,800	68.2	257.4	382,100	641,800	80
85	58.3	249.6	378,500	614,300	61.2	252.2	369,200	607,800	65.5	255.0	355,200	596,600	85
90	55.2	246.1	353,300	574,600	58.3	249.0	344,500	567,600	62.7	252.3	331,400	557,100	90
95	52.0	242.1	330,800	538,700	55.2	245.4	322,600	532,100	59.8	249.3	310,200	522,200	95
100	48.7	237.6	310,600	506,800	52.0	241.4	302,900	500,500	56.7	246.0	291,200	491,200	100
105	45.1	232.5	292,400	476,600	48.7	237.0	285,100	472,200	53.6	242.2	274,100	463,400	105
110	41.3	226.8	275,900	446,600	45.1	231.9	269,000	446,800	50.4	238.0	258,600	438,400	110
115	37.2	220.1	260,800	419,600	41.3	226.2	254,200	423,700	46.9	233.2	244,400	415,800	115
120	32.6	212.3	246,900	388,400	37.2	219.5	240,700	402,700	43.2	227.8	231,400	395,200	120
125	27.2	202.8	234,000	348,800	32.6	211.7	228,300	383,500	39.3	221.7	219,400	376,300	125
130	20.4	190.2	222,000	296,400	27.2	202.2	216,700	357,500	34.9	214.5	208,400	359,000	130
135	8.7	167.3	210,100	230,400	20.4	189.6	205,700	305,900	30.0	205.9	198,000	343,100	135
140					8.8	166.8	194,900	238,600	24.0	195.1	188,300	328,300	140
145									15.8	179.4	179,000	289,500	145
150													150
155													155
160													160
165													165
170													170
175													175
180													180

# MLC650 VPC-MAX S-2

ASME B30.5

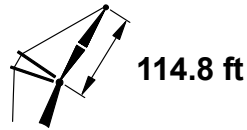
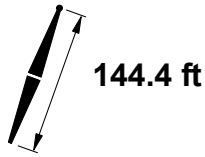
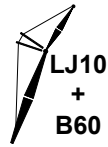

ft	75°				70°				65°				ft
	ft	°	ft	lb	ft	°	ft	lb	ft	°	ft	lb	
55													55
60													60
65													65
70													70
75													75
80													80
85													85
90													90
95													95
100	64.0	250.6	272,000	476,000									100
105	61.1	247.7	255,900	449,000									105
110	58.1	244.5	241,300	424,800									110
115	55.1	241.0	228,000	402,800									115
120	51.9	236.9	215,800	382,800	59.3	241.8	200,300	370,700					120
125	48.5	232.4	204,600	364,500	56.3	238.4	189,900	353,000					125
130	45.0	227.4	194,300	347,800	53.1	234.5	180,200	336,800					130
135	41.1	221.6	184,700	332,300	49.9	230.2	171,200	321,800					135
140	37.0	214.9	175,700	318,000	46.4	225.4	162,900	307,900	54.1	230.7	150,200	298,100	140
145	32.3	207.0	167,300	304,800	42.7	219.9	155,100	295,100	50.9	226.5	143,000	285,700	145
150	26.9	197.4	159,400	292,400	38.7	213.6	147,800	283,100	47.5	221.9	136,200	274,100	150
155	20.0	184.5	151,800	280,800	34.2	206.2	140,900	272,000	43.9	216.6	129,800	263,300	155
160	7.6	160.2	144,000	265,500	29.2	197.4	134,400	261,500	40.0	210.6	123,800	253,200	160
165					23.0	186.1	128,100	251,700	35.7	203.6	118,100	243,700	165
170					14.2	169.1	121,900	242,300	30.9	195.3	112,700	234,800	170
175									25.1	184.9	107,500	226,300	175
180									17.5	170.5	102,300	218,300	180

# MLC650 VPC-MAX S-2

ASME B30.5

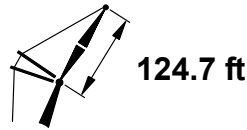
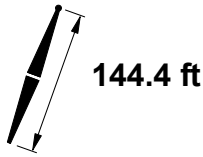

ft	85°				83°				80°				ft
	ft	lb	lb	lb	ft	lb	lb	lb	ft	lb	lb	lb	
60	73.7	272.7	606,900 b	664,400 b									60
65	71.3	271.0	552,400	651,900									65
70	68.8	269.0	506,300	639,000	71.3	270.3	494,500	656,400					70
75	66.3	266.7	466,700	626,100	68.8	268.3	455,800	645,300					75
80	63.7	264.1	432,300	613,300	66.3	266.0	422,200	633,800					80
85	61.1	261.3	402,300	599,600	63.7	263.5	392,800	606,900	67.6	265.9	378,700	595,700	85
90	58.4	258.1	375,700	573,900	61.1	260.6	366,800	566,800	65.0	263.5	353,600	556,300	90
95	55.6	254.6	352,000	538,100	58.4	257.5	343,700	531,400	62.4	260.8	331,200	521,500	95
100	52.6	250.7	330,800	506,300	55.6	254.0	323,000	500,000	59.7	257.8	311,200	490,600	100
105	49.6	246.4	311,700	477,800	52.7	250.1	304,300	471,800	57.0	254.5	293,100	463,000	105
110	46.4	241.5	294,400	450,800	49.6	245.7	287,300	446,500	54.1	250.8	276,800	438,100	110
115	43.0	236.1	278,600	423,800	46.4	240.9	271,900	423,500	51.1	246.7	261,800	415,500	115
120	39.4	230.0	264,100	399,500	43.0	235.5	257,800	402,600	48.0	242.1	248,200	395,000	120
125	35.4	222.9	250,800	376,500	39.4	229.4	244,700	383,500	44.7	237.0	235,600	376,200	125
130	31.0	214.7	238,400	347,500	35.4	222.3	232,700	365,900	41.2	231.2	224,100	359,000	130
135	25.8	204.6	226,900	312,700	31.0	214.1	221,500	349,800	37.4	224.6	213,300	343,100	135
140	19.2	191.2	216,000	267,300	25.8	204.0	211,000	321,500	33.3	217.0	203,300	328,500	140
145	7.5	166.2	205,200	207,700	19.3	190.6	201,100	275,900	28.5	208.0	193,900	314,900	145
150					7.6	165.8	191,200	215,300	22.8	196.5	185,000	302,100	150
155									14.8	179.9	176,400	261,900	155
160													160
165													165
170													170
175													175
180													180
185													185
190													190

# MLC650 VPC-MAX S-2

ASME B30.5

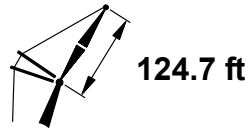
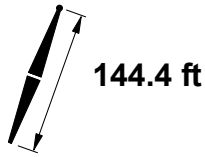
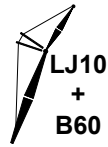

ft	75°				70°				65°				ft
	ft	°	ft	lb	ft	°	ft	lb	ft	°	ft	lb	
60													60
65													65
70													70
75													75
80													80
85													85
90													90
95													95
100													100
105	63.6	259.1	274,600	448,500									105
110	61.0	256.2	259,200	424,300									110
115	58.2	253.0	245,200	402,400									115
120	55.4	249.5	232,300	382,500									120
125	52.5	245.6	220,500	364,300	59.3	250.3	205,500	352,700					125
130	49.5	241.2	209,600	347,600	56.5	246.9	195,300	336,500					130
135	46.3	236.4	199,500	332,200	53.7	243.1	185,800	321,600					135
140	42.9	230.9	190,100	318,000	50.7	238.9	177,000	307,800					140
145	39.2	224.7	181,400	304,800	47.5	234.3	168,800	295,000	54.6	239.2	156,400	285,500	145
150	35.2	217.7	173,200	292,600	44.2	229.1	161,100	283,100	51.6	235.2	149,200	274,000	150
155	30.8	209.3	165,400	281,100	40.7	223.2	153,900	272,100	48.6	230.7	142,500	263,200	155
160	25.5	199.1	158,100	270,400	36.8	216.5	147,100	261,700	45.3	225.7	136,200	253,200	160
165	18.9	185.5	151,000	260,300	32.6	208.7	140,700	252,000	41.8	220.0	130,200	243,800	165
170	6.3	158.7	143,700	239,500	27.7	199.4	134,600	242,800	38.1	213.6	124,600	234,900	170
175					21.8	187.4	128,700	234,100	34.0	206.2	119,200	226,600	175
180					13.1	169.3	122,800	225,800	29.3	197.4	114,100	218,700	180
185									23.8	186.5	109,100	211,200	185
190									16.4	171.1	104,200	204,100	190

# MLC650 VPC-MAX S-2

ASME B30.5



**661,300 lb**

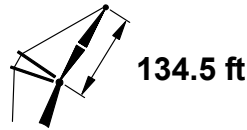
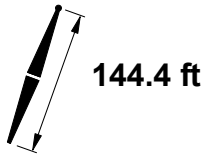

ft	85°				83°				80°				ft
	ft	lb	lb	lb	ft	lb	lb	lb	ft	lb	lb	lb	
60	75.0	283.1	604,500 b	623,300 b									60
65	72.7	281.4	550,100	612,600									65
70	70.5	279.6	503,900	601,400	72.7	280.8	492,000	615,400					70
75	68.2	277.5	464,400	590,100	70.5	279.0	453,300	606,100					75
80	65.8	275.2	430,100	578,700	68.2	276.9	419,800	596,300					80
85	63.4	272.6	400,000	567,400	65.8	274.6	390,400	586,100	69.3	276.6	376,000	592,700	85
90	61.0	269.7	373,500	556,300	63.4	272.0	364,500	564,100	67.0	274.4	350,900	553,400	90
95	58.4	266.6	349,900	535,700	61.0	269.1	341,400	528,900	64.6	272.0	328,600	518,800	95
100	55.9	263.1	328,700	503,900	58.5	266.0	320,700	497,500	62.2	269.3	308,600	488,000	100
105	53.2	259.3	309,700	475,500	55.9	262.5	302,000	469,500	59.7	266.3	290,600	460,500	105
110	50.4	255.1	292,400	449,900	53.2	258.7	285,200	444,200	57.2	263.0	274,300	435,600	110
115	47.5	250.4	276,600	424,300	50.4	254.5	269,800	421,300	54.5	259.3	259,500	413,200	115
120	44.4	245.3	262,200	400,000	47.5	249.8	255,700	400,500	51.8	255.3	245,900	392,700	120
125	41.2	239.5	249,000	377,500	44.4	244.7	242,700	381,400	49.0	250.9	233,400	374,000	125
130	37.7	233.0	236,700	356,400	41.2	238.9	230,800	363,900	46.0	246.0	221,900	356,900	130
135	33.9	225.6	225,400	336,900	37.7	232.4	219,700	347,800	42.8	240.5	211,200	341,100	135
140	29.6	216.8	214,800	310,900	33.9	224.9	209,400	333,000	39.5	234.4	201,300	326,500	140
145	24.6	206.2	204,800	279,900	29.6	216.2	199,800	315,700	35.8	227.5	192,000	312,900	145
150	18.2	192.1	195,400	240,000	24.6	205.6	190,700	288,700	31.8	219.5	183,300	300,300	150
155	6.4	164.8	185,400	185,400	18.2	191.5	182,000	248,000	27.2	209.9	175,100	288,600	155
160					6.5	164.4	173,200	192,400	21.6	197.8	167,300	277,500	160
165									13.8	180.2	159,700	235,800	165
170													170
175													175
180													180
185													185
190													190
195													195
200													200

# MLC650 VPC-MAX S-2

ASME B30.5

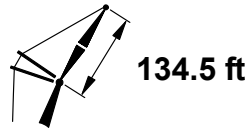
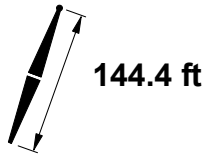
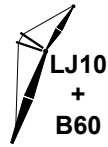

ft	75°				70°				65°				ft
	ft	°	ft	lb	ft	°	ft	lb	ft	°	ft	lb	
60													60
65													65
70													70
75													75
80													80
85													85
90													90
95													95
100													100
105													105
110	63.3	267.5	256,400	421,600									110
115	60.8	264.7	242,400	399,800									115
120	58.3	261.5	229,600	380,000									120
125	55.7	258.0	217,800	361,900									125
130	53.1	254.2	207,000	345,200	59.3	258.7	192,300	333,900					130
135	50.3	250.0	197,000	329,900	56.8	255.4	182,900	319,100					135
140	47.4	245.3	187,700	315,800	54.1	251.7	174,200	305,300					140
145	44.3	240.1	179,000	302,700	51.4	247.6	166,000	292,600					145
150	41.0	234.3	170,900	290,500	48.5	243.1	158,400	280,800	55.0	247.8	146,200	271,500	150
155	37.5	227.8	163,200	279,100	45.5	238.2	151,300	269,800	52.3	243.9	139,600	260,800	155
160	33.7	220.3	156,100	268,400	42.3	232.6	144,600	259,500	49.4	239.5	133,300	250,800	160
165	29.4	211.5	149,300	258,400	38.9	226.4	138,300	249,800	46.5	234.7	127,400	241,400	165
170	24.3	200.7	142,800	249,000	35.2	219.3	132,300	240,800	43.4	229.3	121,900	232,700	170
175	17.8	186.4	136,500	240,100	31.1	211.1	126,700	232,200	40.0	223.3	116,600	224,400	175
180	4.9	156.5	129,900	213,700	26.4	201.2	121,200	224,100	36.4	216.5	111,600	216,600	180
185					20.7	188.6	116,000	216,400	32.5	208.7	106,800	209,200	185
190					12.2	169.3	110,700	209,000	28.0	199.4	102,200	202,200	190
195									22.6	187.9	97,800	195,500	195
200									15.4	171.7	93,400	189,100	200

# MLC650 VPC-MAX S-2

ASME B30.5



**661,300 lb**

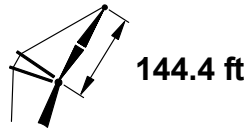
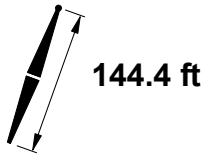

ft	85°				83°				80°				ft
	ft	lb	lb	lb	ft	lb	lb	lb	ft	lb	lb	lb	
65	73.9	291.8	548,300	573,800									65
70	71.9	290.1	502,200	564,300									70
75	69.7	288.2	462,700	554,500	71.9	289.5	451,500	567,500					75
80	67.6	286.0	428,400	544,600	69.7	287.5	418,000	559,200					80
85	65.4	283.7	398,400	534,600	67.6	285.4	388,700	550,500					85
90	63.1	281.1	371,900	524,700	65.4	283.1	362,700	541,600	68.7	285.2	349,100	551,100	90
95	60.9	278.2	348,300	514,900	63.2	280.5	339,700	526,800	66.5	283.0	326,800	516,600	95
100	58.5	275.1	327,200	502,000	60.9	277.6	319,000	495,500	64.3	280.5	306,800	485,900	100
105	56.1	271.7	308,200	473,600	58.5	274.5	300,400	467,500	62.0	277.8	288,900	458,500	105
110	53.6	267.9	290,900	448,100	56.1	271.0	283,600	442,300	59.7	274.8	272,600	433,700	110
115	51.1	263.8	275,200	425,000	53.6	267.3	268,200	419,500	57.3	271.5	257,800	411,300	115
120	48.4	259.3	260,800	400,900	51.1	263.2	254,200	398,700	54.9	267.9	244,200	390,900	120
125	45.6	254.3	247,600	378,400	48.4	258.7	241,300	379,800	52.4	264.0	231,800	372,300	125
130	42.7	248.8	235,500	357,500	45.6	253.7	229,400	362,300	49.7	259.7	220,300	355,200	130
135	39.5	242.7	224,200	338,300	42.7	248.2	218,400	346,300	47.0	254.9	209,700	339,500	135
140	36.2	235.9	213,700	320,600	39.5	242.1	208,200	331,500	44.1	249.7	199,800	324,900	140
145	32.5	228.0	203,900	303,600	36.2	235.3	198,600	317,700	41.1	243.9	190,600	311,400	145
150	28.3	218.9	194,700	280,300	32.5	227.4	189,700	304,800	37.9	237.5	182,000	298,900	150
155	23.5	207.7	186,100	252,300	28.3	218.3	181,300	284,800	34.4	230.2	174,000	287,200	155
160	17.3	192.9	177,800	216,900	23.5	207.1	173,300	260,600	30.5	221.7	166,400	276,200	160
165	5.1	162.7	166,000	166,000	17.3	192.3	165,700	224,300	26.0	211.7	159,200	266,000	165
170					5.2	162.4	157,800	172,500	20.6	199.0	152,300	254,600	170
175									12.9	180.4	145,500	213,700	175
180													180
185													185
190													190
195													195
200													200
205													205
210													210



# MLC650 VPC-MAX S-2

ASME B30.5

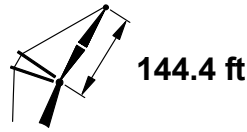
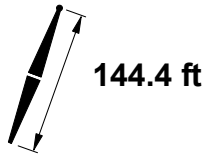
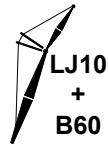

ft	75°				70°				65°				ft
	ft	°	ft	lb	ft	°	ft	lb	ft	°	ft	lb	
65													65
70													70
75													75
80													80
85													85
90													90
95													95
100													100
105													105
110													110
115	63.0	276.0	240,500	397,900									115
120	60.8	273.2	227,700	378,100									120
125	58.4	270.0	216,000	360,000									125
130	56.0	266.6	205,200	343,500									130
135	53.5	262.8	195,200	328,200	59.3	267.2	181,000	317,200					135
140	50.9	258.7	185,900	314,100	57.0	263.9	172,300	303,600					140
145	48.3	254.1	177,300	301,000	54.5	260.3	164,200	290,900					145
150	45.5	249.2	169,300	288,900	52.0	256.3	156,600	279,100					150
155	42.5	243.7	161,700	277,600	49.3	251.9	149,500	268,100					155
160	39.4	237.5	154,600	267,000	46.6	247.1	142,900	257,900	52.8	252.5	131,400	249,100	160
165	36.0	230.6	147,900	257,000	43.7	241.8	136,600	248,300	50.2	248.2	125,500	239,800	165
170	32.3	222.7	141,600	247,700	40.6	236.0	130,700	239,300	47.5	243.6	120,000	231,000	170
175	28.1	213.5	135,600	238,900	37.4	229.4	125,200	230,800	44.6	238.5	114,800	222,800	175
180	23.2	202.2	129,800	230,600	33.8	221.9	119,900	222,700	41.6	232.8	109,900	215,100	180
185	16.9	187.1	124,200	222,700	29.8	213.3	114,800	215,200	38.4	226.4	105,200	207,700	185
190	2.8	152.0	118,000	189,500	25.3	202.9	109,900	208,000	35.0	219.3	100,700	200,800	190
195					19.7	189.7	105,200	201,100	31.1	211.1	96,400	194,200	195
200					11.3	169.2	100,400	194,500	26.8	201.3	92,300	187,900	200
205									21.6	189.2	88,300	181,900	205
210									14.5	172.1	84,300	176,100	210

# MLC650 VPC-MAX S-2

ASME B30.5

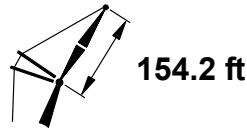
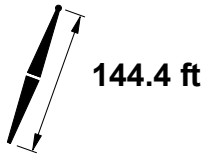

ft	85°				83°				80°				ft
	ft	lb	lb	lb	ft	lb	lb	lb	ft	lb	lb	lb	
70	73.1	300.5	528,600	532,100									70
75	71.1	298.7	487,100	523,600									75
80	69.1	296.8	451,000	514,900	71.1	298.1	440,400	526,900					80
85	67.1	294.6	419,500	506,100	69.1	296.1	409,500	519,500					85
90	65.0	292.2	391,600	497,200	67.1	294.0	382,300	511,800					90
95	62.9	289.6	366,800	488,400	65.0	291.6	358,000	503,900	68.1	293.8	344,900	513,900	95
100	60.8	286.7	344,700	479,700	62.9	288.9	336,300	493,100	66.0	291.5	323,900	483,300	100
105	58.6	283.6	324,700	467,500	60.8	286.1	316,800	465,200	64.0	289.0	304,900	455,900	105
110	56.3	280.2	306,600	443,800	58.6	282.9	299,000	440,000	61.8	286.2	287,800	431,300	110
115	54.0	276.5	290,100	420,600	56.3	279.5	282,900	417,300	59.7	283.2	272,200	408,900	115
120	51.6	272.5	275,000	398,400	54.0	275.9	268,200	396,600	57.5	280.0	258,000	388,600	120
125	49.2	268.1	261,200	377,200	51.6	271.8	254,600	377,600	55.2	276.4	244,900	370,000	125
130	46.6	263.3	248,400	357,300	49.2	267.5	242,200	360,300	52.8	272.6	232,800	353,000	130
135	43.9	258.0	236,600	338,300	46.6	262.7	230,600	344,300	50.4	268.4	221,700	337,300	135
140	41.1	252.2	225,600	320,800	43.9	257.4	219,900	329,500	47.9	263.8	211,300	322,800	140
145	38.0	245.8	215,400	304,500	41.1	251.6	210,000	315,800	45.3	258.8	201,700	309,400	145
150	34.8	238.6	205,900	289,500	38.1	245.2	200,600	303,100	42.5	253.3	192,700	296,900	150
155	31.2	230.4	196,900	273,700	34.8	238.0	191,900	290,000	39.6	247.2	184,300	285,200	155
160	27.2	220.8	188,500	253,300	31.2	229.8	183,700	275,900	36.4	240.4	176,400	274,400	160
165	22.5	209.2	180,500	227,800	27.2	220.2	175,900	257,500	33.0	232.7	168,900	264,100	165
170	16.4	193.6	172,800	196,000	22.5	208.6	168,500	235,400	29.3	223.9	161,900	254,600	170
175	3.5	159.4	146,800	146,800	16.4	193.0	161,400	202,900	25.0	213.4	155,200	245,500	175
180					3.7	159.3	153,100	153,100	19.7	200.1	148,700	230,500	180
185									12.1	180.5	142,300	193,500	185
190													190
195													195
200													200
205													205
210													210
215													215
220													220

# MLC650 VPC-MAX S-2

ASME B30.5

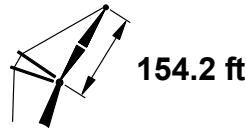
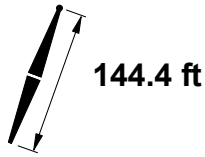

ft	75°				70°				65°				ft
	ft	°	ft	lb	ft	°	ft	lb	ft	°	ft	lb	
70													70
75													75
80													80
85													85
90													90
95													95
100													100
105													105
110													110
115	64.9	287.1	254,600	395,300									115
120	62.8	284.5	241,100	375,600									120
125	60.7	281.6	228,800	357,600									125
130	58.5	278.5	217,400	341,100									130
135	56.2	275.1	206,900	325,900									135
140	53.9	271.4	197,100	311,800	59.4	275.7	183,100	301,100					140
145	51.5	267.3	188,100	298,800	57.1	272.4	174,600	288,500					145
150	49.1	262.9	179,600	286,700	54.8	268.8	166,600	276,700					150
155	46.5	258.1	171,700	275,400	52.5	264.9	159,200	265,800					155
160	43.8	252.9	164,200	264,900	50.0	260.7	152,200	255,600					160
165	40.9	247.0	157,200	255,000	47.5	256.0	145,600	246,000	53.2	261.1	134,200	237,400	165
170	37.9	240.6	150,600	245,700	44.9	250.9	139,400	237,100	50.8	256.9	128,400	228,700	170
175	34.6	233.3	144,400	237,000	42.1	245.3	133,600	228,600	48.3	252.4	122,900	220,500	175
180	31.0	225.1	138,400	228,700	39.1	239.2	128,000	220,700	45.7	247.5	117,700	212,800	180
185	27.0	215.4	132,800	220,900	36.0	232.2	122,800	213,100	43.0	242.1	112,800	205,500	185
190	22.2	203.6	127,300	213,500	32.5	224.4	117,700	206,000	40.1	236.1	108,100	198,600	190
195	16.1	187.8	122,000	206,500	28.7	215.4	112,900	199,200	37.0	229.4	103,700	192,100	195
200					24.2	204.6	108,300	192,800	33.6	221.9	99,400	185,900	200
205					18.8	190.7	103,800	186,600	29.9	213.3	95,300	180,000	205
210					10.5	169.0	99,200	180,600	25.7	203.1	91,300	174,300	210
215									20.7	190.4	87,500	168,900	215
220									13.7	172.5	83,600	163,600	220

# MLC650 VPC-MAX S-2

ASME B30.5



**661,300 lb**

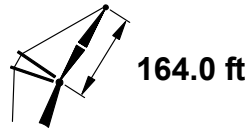
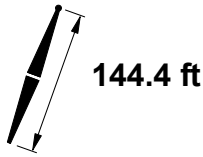

ft	85°				83°				80°				ft
	ft	lb	lb	lb	ft	lb	lb	lb	ft	lb	lb	lb	
70	74.1	310.9	495,400	495,400									70
75	72.3	309.2	486,500	495,400									75
80	70.4	307.4	450,500	487,800	72.3	308.6	439,800	490,500					80
85	68.5	305.3	419,000	480,000	70.4	306.7	408,900	490,500					85
90	66.6	303.1	391,100	472,200	68.5	304.7	381,700	484,600					90
95	64.7	300.7	366,400	464,300	66.6	302.5	357,500	477,700	69.5	304.4	344,200	475,800	95
100	62.7	298.0	344,200	456,400	64.7	300.1	335,800	470,600	67.6	302.3	323,200	475,800	100
105	60.7	295.2	324,200	448,600	62.7	297.4	316,200	463,400	65.7	300.0	304,300	454,800	105
110	58.6	292.1	306,100	429,900	60.7	294.5	298,500	439,000	63.7	297.5	287,200	430,200	110
115	56.5	288.7	289,700	409,200	58.6	291.4	282,400	416,300	61.7	294.7	271,600	407,900	115
120	54.4	285.0	274,600	388,900	56.5	288.1	267,700	395,700	59.7	291.7	257,400	387,700	120
125	52.1	281.1	260,800	369,300	54.4	284.4	254,200	376,800	57.6	288.5	244,300	369,200	125
130	49.8	276.8	248,100	350,600	52.2	280.5	241,800	359,500	55.5	285.0	232,300	352,200	130
135	47.5	272.2	236,300	332,800	49.9	276.2	230,300	343,600	53.3	281.2	221,200	336,500	135
140	45.0	267.1	225,400	316,100	47.5	271.5	219,600	328,800	51.0	277.1	210,900	322,100	140
145	42.4	261.6	215,300	300,500	45.0	266.5	209,700	315,200	48.7	272.6	201,300	308,700	145
150	39.6	255.5	205,800	286,200	42.4	261.0	200,400	302,500	46.2	267.8	192,300	296,200	150
155	36.7	248.8	196,900	273,100	39.6	254.9	191,700	290,700	43.7	262.5	184,000	284,600	155
160	33.5	241.2	188,500	261,200	36.7	248.2	183,600	277,600	41.0	256.7	176,100	273,800	160
165	30.1	232.7	180,700	249,400	33.6	240.6	175,900	264,600	38.2	250.3	168,700	263,600	165
170	26.2	222.7	173,200	231,300	30.1	232.1	168,600	252,400	35.2	243.2	161,700	254,100	170
175	21.6	210.5	166,100	207,800	26.2	222.1	161,700	235,300	31.9	235.2	155,100	245,100	175
180	15.6	194.2	159,200	179,200	21.6	209.9	155,200	214,900	28.2	226.0	148,800	236,600	180
185					15.6	193.6	148,800	185,600	24.0	215.0	142,800	228,600	185
190									18.8	201.2	137,100	210,900	190
195									11.4	180.5	131,300	177,100	195
200													200
205													205
210													210
215													215
220													220
230													230

# MLC650 VPC-MAX S-2

ASME B30.5

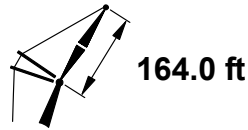
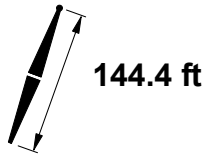

ft	75°				70°				65°				ft
	ft	°	ft	lb	ft	°	ft	lb	ft	°	ft	lb	
70													70
75													75
80													80
85													85
90													90
95													95
100													100
105													105
110													110
115													115
120	64.6	295.6	240,300	374,500									120
125	62.6	293.0	228,000	356,600									125
130	60.6	290.1	216,700	340,100									130
135	58.5	287.0	206,200	325,000									135
140	56.4	283.6	196,500	311,000									140
145	54.3	279.9	187,400	298,000	59.4	284.2	173,800	287,600					145
150	52.0	276.0	179,000	285,900	57.3	280.9	165,900	275,900					150
155	49.7	271.7	171,100	274,700	55.1	277.4	158,400	265,000					155
160	47.4	267.0	163,700	264,200	52.9	273.5	151,500	254,800					160
165	44.9	261.9	156,700	254,300	50.7	269.4	144,900	245,300					165
170	42.3	256.4	150,200	245,100	48.3	264.8	138,800	236,300	53.6	269.7	127,600	227,900	170
175	39.5	250.3	144,000	236,400	45.9	259.9	133,000	227,900	51.4	265.6	122,200	219,700	175
180	36.6	243.5	138,100	228,200	43.3	254.6	127,500	220,000	49.1	261.2	117,000	212,000	180
185	33.4	236.0	132,600	220,500	40.6	248.7	122,300	212,500	46.6	256.4	112,100	204,800	185
190	29.9	227.3	127,200	213,100	37.7	242.2	117,300	205,400	44.1	251.2	107,500	197,900	190
195	26.0	217.3	122,200	206,200	34.7	235.0	112,600	198,700	41.5	245.5	103,100	191,400	195
200	21.4	205.0	117,200	199,500	31.3	226.8	108,100	192,300	38.7	239.2	98,900	185,300	200
205	15.3	188.4	112,400	193,200	27.6	217.4	103,700	186,200	35.7	232.3	94,900	179,400	205
210					23.3	206.1	99,500	180,400	32.4	224.4	91,000	173,800	210
215					17.9	191.6	95,400	174,900	28.8	215.4	87,300	168,500	215
220					9.7	168.7	91,200	169,400	24.7	204.8	83,700	163,400	220
230									13.0	172.7	76,600	153,700	230

# MLC650 VPC-MAX S-2

ASME B30.5



661,300 lb



360°

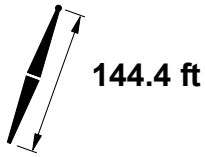

144.4 ft



173.9 ft

ft	85°				83°				80°				ft
	ft	lb	lb	lb	ft	lb	lb	lb	ft	lb	lb	lb	
75	73.3	319.6	453,300	453,300									75
80	71.6	317.9	448,200	453,200									80
85	69.8	316.0	416,700	452,000	71.6	317.2	406,500	448,800					85
90	68.0	313.9	388,900	445,100	69.8	315.3	379,300	448,800					90
95	66.2	311.6	364,100	438,000	68.0	313.3	355,100	448,800					95
100	64.4	309.2	342,000	431,000	66.2	311.0	333,400	443,100	68.9	313.0	320,600	434,900	100
105	62.5	306.5	322,000	424,000	64.4	308.5	313,900	436,900	67.1	310.9	301,700	434,900	105
110	60.6	303.6	303,900	416,300	62.5	305.9	296,200	430,500	65.3	308.5	284,600	427,800	110
115	58.7	300.5	287,500	398,200	60.6	303.0	280,100	414,100	63.5	305.9	269,100	405,600	115
120	56.7	297.2	272,500	380,200	58.7	299.9	265,400	393,500	61.6	303.2	254,900	385,400	120
125	54.7	293.6	258,700	362,400	56.7	296.6	251,900	374,700	59.7	300.2	241,900	366,900	125
130	52.6	289.7	246,000	345,100	54.7	293.0	239,500	357,400	57.7	297.0	229,900	350,000	130
135	50.4	285.5	234,200	328,400	52.6	289.1	228,000	341,500	55.7	293.5	218,800	334,400	135
140	48.2	281.0	223,400	312,600	50.4	284.9	217,400	326,800	53.6	289.8	208,500	319,900	140
145	45.9	276.1	213,200	297,500	48.2	280.4	207,500	313,200	51.5	285.7	198,900	306,600	145
150	43.5	270.8	203,800	283,400	45.9	275.5	198,300	300,600	49.3	281.4	190,000	294,200	150
155	41.0	265.0	194,900	270,200	43.5	270.2	189,600	288,800	47.1	276.7	181,700	282,600	155
160	38.3	258.6	186,600	258,000	41.0	264.4	181,500	277,500	44.7	271.6	173,900	271,800	160
165	35.5	251.6	178,800	246,900	38.3	258.0	173,900	264,600	42.3	266.0	166,500	261,700	165
170	32.4	243.8	171,500	237,000	35.5	251.0	166,700	252,500	39.7	260.0	159,600	252,200	170
175	29.0	234.8	164,500	226,800	32.4	243.1	159,900	241,200	36.9	253.3	153,000	243,200	175
180	25.2	224.4	157,800	210,600	29.1	234.2	153,500	230,400	34.0	245.9	146,800	234,800	180
185	20.7	211.8	151,500	188,700	25.3	223.8	147,300	214,300	30.8	237.5	140,900	226,800	185
190	14.9	194.7	145,300	162,600	20.8	211.2	141,400	195,300	27.2	227.9	135,300	219,300	190
195					14.9	194.2	135,700	168,700	23.1	216.5	129,900	211,300	195
200									18.1	202.1	124,700	192,000	200
205									10.7	180.3	119,500	161,000	205
210													210
215													215
220													220
230													230
240													240

# MLC650 VPC-MAX S-2

ASME B30.5

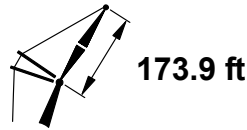
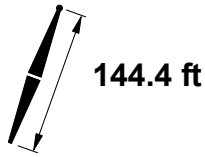

ft	75°				70°				65°				ft
	ft	°	ft	lb	ft	°	ft	lb	ft	°	ft	lb	
75													75
80													80
85													85
90													90
95													95
100													100
105													105
110													110
115													115
120													120
125	64.3	304.1	225,200	354,100									125
130	62.4	301.5	213,900	337,700									130
135	60.5	298.6	203,500	322,600									135
140	58.6	295.5	193,800	308,700									140
145	56.6	292.1	184,800	295,700									145
150	54.6	288.5	176,400	283,700	59.4	292.7	163,000	273,500					150
155	52.5	284.6	168,500	272,500	57.4	289.4	155,600	262,600					155
160	50.3	280.4	161,200	262,000	55.4	285.9	148,700	252,500					160
165	48.1	275.9	154,300	252,200	53.3	282.1	142,200	243,000					165
170	45.8	270.9	147,700	243,000	51.2	278.0	136,100	234,100					170
175	43.4	265.6	141,600	234,400	49.0	273.6	130,300	225,700	54.0	278.2	119,300	217,400	175
180	40.9	259.8	135,800	226,200	46.7	268.9	124,900	217,800	51.9	274.2	114,200	209,700	180
185	38.2	253.4	130,300	218,500	44.4	263.7	119,700	210,400	49.7	269.9	109,300	202,500	185
190	35.3	246.3	125,000	211,200	41.9	258.1	114,800	203,300	47.5	265.3	104,700	195,700	190
195	32.3	238.4	120,000	204,300	39.3	251.9	110,100	196,700	45.1	260.3	100,400	189,200	195
200	28.9	229.5	115,200	197,700	36.5	245.1	105,700	190,300	42.7	254.8	96,200	183,100	200
205	25.1	219.0	110,700	191,500	33.5	237.6	101,400	184,300	40.1	248.8	92,200	177,300	205
210	20.5	206.2	106,200	185,500	30.3	229.1	97,300	178,500	37.4	242.3	88,400	171,700	210
215	14.6	188.9	101,800	179,700	26.6	219.3	93,400	173,000	34.5	235.0	84,800	166,400	215
220					22.4	207.5	89,600	167,800	31.3	226.8	81,300	161,400	220
230					9.0	168.2	81,900	157,800	23.8	206.4	74,600	151,900	230
240									12.3	172.8	68,100	143,000	240

# MLC650 VPC-MAX S-2

ASME B30.5



661,300 lb

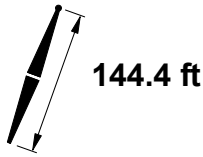

144.4 ft



193.6 ft

ft	85°				83°				80°				ft
	ft	lb	lb	lb	ft	lb	lb	lb	ft	lb	lb	lb	
80	73.5	338.7	379,200	379,200									80
85	72.0	337.0	379,100	379,100									85
90	70.4	335.1	378,300	378,300	72.0	336.3	374,200	374,200					90
95	68.8	333.1	361,300	377,500	70.4	334.5	351,900	374,200					95
100	67.2	331.0	339,100	376,500	68.8	332.5	330,300	374,200					100
105	65.5	328.7	319,200	375,200	67.2	330.4	310,800	374,200	69.6	332.2	298,300	360,800	105
110	63.9	326.2	301,100	373,800	65.6	328.0	293,200	374,200	68.0	330.2	281,300	360,800	110
115	62.2	323.5	284,700	369,000	63.9	325.5	277,100	374,200	66.4	327.9	265,800	360,800	115
120	60.5	320.6	269,700	356,500	62.2	322.8	262,500	373,100	64.7	325.5	251,600	360,800	120
125	58.8	317.5	256,000	342,700	60.5	320.0	249,000	363,400	63.1	322.9	238,700	360,800	125
130	57.0	314.2	243,300	328,900	58.8	316.9	236,600	353,500	61.4	320.1	226,700	346,800	130
135	55.2	310.7	231,600	315,200	57.0	313.6	225,200	338,600	59.6	317.1	215,700	331,300	135
140	53.3	306.9	220,700	301,800	55.2	310.0	214,600	324,000	57.9	314.0	205,400	317,000	140
145	51.4	302.9	210,700	288,600	53.3	306.3	204,700	310,500	56.1	310.5	195,900	303,700	145
150	49.5	298.5	201,200	275,900	51.4	302.2	195,500	297,900	54.3	306.9	187,000	291,300	150
155	47.4	293.9	192,500	263,700	49.5	297.9	187,000	286,100	52.4	303.0	178,700	279,800	155
160	45.4	288.9	184,200	252,100	47.5	293.3	178,900	275,200	50.5	298.8	171,000	269,100	160
165	43.2	283.5	176,500	241,100	45.4	288.3	171,300	264,800	48.5	294.3	163,700	259,000	165
170	40.9	277.7	169,200	230,800	43.2	282.9	164,200	252,900	46.4	289.5	156,800	249,500	170
175	38.5	271.4	162,300	221,200	40.9	277.1	157,500	241,800	44.3	284.3	150,300	240,600	175
180	36.0	264.5	155,800	212,200	38.5	270.8	151,200	231,300	42.1	278.8	144,200	232,300	180
185	33.3	256.9	149,600	204,100	36.0	263.9	145,100	221,400	39.7	272.7	138,400	224,400	185
190	30.4	248.5	143,700	196,800	33.3	256.3	139,400	212,100	37.3	266.1	132,900	216,900	190
195	27.2	238.9	138,100	190,100	30.4	247.9	134,000	203,200	34.7	258.9	127,700	209,800	195
200	23.6	227.7	132,800	176,900	27.2	238.3	128,800	193,300	31.9	250.9	122,700	203,100	200
205	19.3	214.0	127,600	157,600	23.6	227.1	123,800	180,200	28.9	241.9	117,900	196,700	205
210	13.6	195.5	122,500	135,600	19.3	213.4	118,900	163,500	25.5	231.6	113,300	190,600	210
215					13.6	195.0	114,200	141,000	21.5	219.3	108,900	178,100	215
220									16.7	203.7	104,500	161,200	220
230													230
240													240
250													250
260													260



# MLC650 VPC-MAX S-2

ASME B30.5

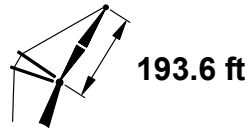
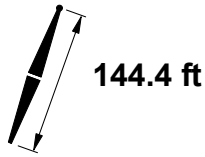

ft	75°				70°				65°				ft
	ft	°	ft	lb	ft	°	ft	lb	ft	°	ft	lb	
80													80
85													85
90													90
95													95
100													100
105													105
110													110
115													115
120													120
125													125
130													130
135													135
140	63.8	321.1	199,900	319,300									140
145	60.4	315.5	181,300	292,500									145
150	58.7	312.4	173,000	280,600									150
155	56.9	309.1	165,200	269,400									155
160	55.1	305.6	157,900	259,000	59.4	309.6	145,000	249,300					160
165	53.2	301.8	151,000	249,300	57.6	306.4	138,500	239,800					165
170	51.3	297.7	144,500	240,100	55.8	302.9	132,500	231,000					170
175	49.4	293.4	138,400	231,500	54.0	299.2	126,800	222,700					175
180	47.4	288.7	132,700	223,400	52.1	295.3	121,400	214,800					180
185	45.3	283.7	127,300	215,800	50.2	291.1	116,300	207,400	54.6	295.3	105,600	199,300	185
190	43.1	278.4	122,100	208,600	48.2	286.6	111,400	200,400	52.7	291.5	101,000	192,600	190
195	40.8	272.5	117,200	201,700	46.1	281.7	106,800	193,800	50.8	287.3	96,700	186,200	195
200	38.4	266.2	112,500	195,200	44.0	276.5	102,500	187,500	48.8	282.9	92,600	180,100	200
205	35.9	259.3	108,000	189,000	41.7	270.8	98,300	181,600	46.8	278.2	88,700	174,300	205
210	33.2	251.6	103,800	183,200	39.4	264.7	94,300	175,900	44.6	273.1	85,000	168,800	210
215	30.3	243.1	99,700	177,500	36.9	258.0	90,500	170,500	42.4	267.5	81,500	163,600	215
220	27.1	233.5	95,700	172,200	34.3	250.7	86,800	165,300	40.1	261.6	78,000	158,600	220
230	19.1	208.4	88,200	162,100	28.4	233.4	79,900	155,600	35.1	248.0	71,600	149,300	230
240					20.9	210.2	73,400	146,700	29.4	231.3	65,700	140,700	240
250					7.7	166.8	66,900	138,300	22.2	209.3	60,100	132,800	250
260									11.0	172.8	54,500	125,300	260

# MLC650 VPC-MAX S-2

ASME B30.5



661,300 lb

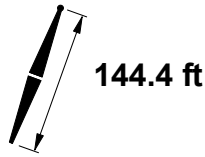

144.4 ft

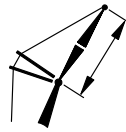

213.3 ft

ft	85°				83°				80°				ft
	ft	lb	lb	lb	ft	lb	lb	lb	ft	lb	lb	lb	
85	73.7	357.7	320,400	320,400									85
90	72.3	356.1	320,000	320,000									90
95	70.8	354.3	319,400	319,400	72.3	355.4	315,800	315,800					95
100	69.4	352.4	318,600	318,600	70.8	353.7	315,800	315,800					100
105	68.0	350.3	316,300	317,600	69.4	351.7	307,700	315,800					105
110	66.5	348.1	298,300	316,500	68.0	349.7	290,100	315,800					110
115	65.0	345.7	281,900	315,200	66.5	347.4	274,100	315,800	68.7	349.4	262,500	306,100	115
120	63.5	343.1	266,900	313,600	65.0	345.1	259,500	315,400	67.2	347.3	248,300	306,100	120
125	62.0	340.4	253,200	312,000	63.5	342.5	246,000	314,800	65.7	345.0	235,400	306,100	125
130	60.4	337.5	240,500	304,900	62.0	339.8	233,700	314,100	64.2	342.5	223,500	306,100	130
135	58.8	334.5	228,800	294,400	60.4	336.9	222,300	313,200	62.7	339.9	212,500	306,100	135
140	57.2	331.2	218,000	283,800	58.8	333.8	211,700	312,200	61.2	337.1	202,200	306,100	140
145	55.6	327.7	207,900	273,300	57.2	330.6	201,800	307,600	59.6	334.1	192,800	300,700	145
150	53.9	324.0	198,500	262,800	55.6	327.1	192,700	295,100	58.0	330.9	183,900	288,400	150
155	52.2	320.1	189,800	252,500	53.9	323.4	184,100	283,400	56.4	327.6	175,700	277,000	155
160	50.5	315.9	181,600	242,500	52.2	319.5	176,100	272,500	54.8	324.0	167,900	266,300	160
165	48.7	311.5	173,900	232,800	50.5	315.3	168,600	262,300	53.1	320.2	160,700	256,200	165
170	46.8	306.8	166,600	223,500	48.7	310.9	161,500	251,900	51.3	316.1	153,800	246,800	170
175	44.9	301.7	159,800	214,600	46.8	306.1	154,800	240,900	49.6	311.8	147,400	238,000	175
180	42.9	296.3	153,300	206,000	44.9	301.1	148,500	230,600	47.7	307.2	141,300	229,700	180
185	40.9	290.5	147,200	197,900	42.9	295.7	142,500	220,800	45.9	302.3	135,600	221,800	185
190	38.7	284.2	141,400	190,300	40.9	289.9	136,900	211,600	43.9	297.1	130,100	214,300	190
195	36.4	277.4	135,900	183,200	38.7	283.6	131,500	203,000	41.9	291.5	124,900	207,300	195
200	34.1	270.0	130,600	176,700	36.5	276.8	126,400	194,800	39.8	285.5	120,000	200,600	200
205	31.5	261.9	125,600	170,600	34.1	269.4	121,500	186,900	37.6	279.0	115,300	194,300	205
210	28.7	252.8	120,800	165,200	31.5	261.3	116,800	179,500	35.3	271.9	110,800	188,200	210
215	25.6	242.6	116,200	160,100	28.7	252.2	112,400	172,300	32.8	264.1	106,500	182,500	215
220	22.2	230.6	111,800	148,500	25.7	242.0	108,100	163,000	30.1	255.6	102,400	176,300	220
230	12.5	196.0	103,200	112,800	18.0	215.4	99,900	137,000	24.0	234.9	94,600	161,800	230
240									15.5	205.1	87,300	135,400	240
250													250
260													260
270													270
280													280

# MLC650 VPC-MAX S-2

ASME B30.5

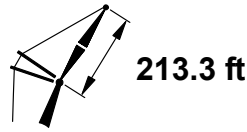
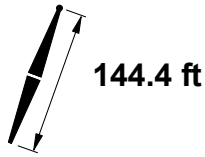

ft	75°				70°				65°				ft
	ft	°	ft	lb	ft	°	ft	lb	ft	°	ft	lb	
85													85
90													90
95													95
100													100
105													105
110													110
115													115
120													120
125													125
130													130
135													135
140	64.9	340.6	186,700	283,300									140
145	63.4	338.1	177,800	283,300									145
150	61.9	335.4	169,500	277,400									150
155	60.3	332.5	161,700	266,400									155
160	58.8	329.4	154,400	256,000									160
165	57.2	326.1	147,600	246,300									165
170	55.5	322.6	141,200	237,200	59.4	326.6	128,800	227,800					170
175	53.8	318.9	135,200	228,700	57.8	323.4	123,200	219,600					175
180	52.1	315.0	129,500	220,600	56.2	320.0	117,800	211,800					180
185	50.4	310.8	124,000	213,000	54.5	316.4	112,700	204,400					185
190	48.6	306.4	118,900	205,800	52.8	312.5	107,900	197,500					190
195	46.7	301.6	114,100	199,000	51.1	308.4	103,400	190,900					195
200	44.8	296.5	109,400	192,600	49.3	304.1	99,100	184,700	53.4	308.7	88,900	177,100	200
205	42.8	291.1	105,000	186,400	47.5	299.5	94,900	178,800	51.6	304.6	85,100	171,300	205
210	40.8	285.3	100,800	180,600	45.6	294.5	91,000	173,100	49.9	300.4	81,400	165,900	210
215	38.6	279.0	96,800	175,000	43.6	289.2	87,300	167,700	48.1	295.8	77,900	160,700	215
220	36.3	272.2	93,000	169,700	41.6	283.6	83,700	162,600	46.2	291.0	74,600	155,700	220
230	31.4	256.6	85,800	159,800	37.3	270.9	76,900	153,100	42.2	280.3	68,300	146,500	230
240	25.5	237.1	79,000	150,700	32.4	255.8	70,700	144,300	38.0	267.9	62,500	138,000	240
250	17.8	210.3	72,700	142,300	26.8	237.3	64,900	136,200	33.2	253.3	57,100	130,200	250
260					19.6	212.5	59,400	128,700	27.7	235.5	52,100	123,000	260
270					6.4	164.6	53,700	121,500	20.9	212.0	47,200	116,300	270
280									9.9	172.4	42,400	109,900	280

# MLC650 VPC-MAX S-2

ASME B30.5



661,300 lb



360°

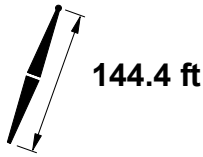

144.4 ft

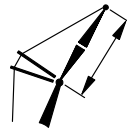

232.9 ft

ft	85°				83°				80°				ft
	ft	lb	lb	lb	ft	lb	lb	lb	ft	lb	lb	lb	
90	73.8	376.8	269,000	269,000									90
95	72.5	375.2	268,400	268,400									95
100	71.2	373.4	267,600	267,600	72.5	374.5	264,300	264,300					100
105	69.9	371.5	266,800	266,800	71.2	372.8	264,200	264,200					105
110	68.6	369.5	265,800	265,800	69.9	370.9	264,000	264,000					110
115	67.3	367.4	264,800	264,800	68.6	368.9	263,700	263,700					115
120	65.9	365.1	263,600	263,600	67.3	366.8	257,400	263,200	69.3	368.6	246,100	254,700	120
125	64.5	362.7	251,300	262,400	65.9	364.5	244,000	262,600	67.9	366.6	233,100	254,700	125
130	63.1	360.1	238,600	261,100	64.5	362.1	231,700	261,900	66.6	364.4	221,200	254,700	130
135	61.7	357.4	227,000	259,800	63.2	359.5	220,300	261,100	65.2	362.0	210,200	254,700	135
140	60.3	354.5	216,200	258,400	61.8	356.8	209,700	260,300	63.8	359.5	200,100	254,700	140
145	58.9	351.4	206,100	256,600	60.3	353.9	199,900	259,400	62.5	356.8	190,600	254,700	145
150	57.4	348.2	196,700	248,500	58.9	350.8	190,700	258,400	61.0	354.0	181,800	254,700	150
155	55.9	344.8	188,000	240,400	57.4	347.6	182,200	257,400	59.6	351.1	173,600	254,700	155
160	54.4	341.1	179,800	232,300	55.9	344.1	174,200	256,400	58.2	347.9	165,800	254,700	160
165	52.9	337.3	172,100	224,200	54.4	340.5	166,700	254,300	56.7	344.6	158,600	254,200	165
170	51.3	333.3	164,900	216,200	52.9	336.7	159,600	246,300	55.2	341.1	151,800	244,800	170
175	49.7	329.0	158,100	208,500	51.3	332.6	153,000	238,500	53.6	337.3	145,400	236,000	175
180	48.0	324.4	151,700	200,900	49.7	328.3	146,700	230,700	52.1	333.4	139,300	227,700	180
185	46.3	319.6	145,600	193,500	48.0	323.8	140,800	221,000	50.5	329.2	133,600	219,900	185
190	44.5	314.5	139,800	186,400	46.3	319.0	135,200	211,900	48.8	324.8	128,200	212,500	190
195	42.7	309.0	134,300	179,600	44.5	313.9	129,800	203,300	47.1	320.1	123,100	205,500	195
200	40.8	303.2	129,100	173,100	42.7	308.4	124,700	195,100	45.4	315.2	118,200	198,900	200
205	38.9	297.0	124,200	167,000	40.8	302.6	119,900	187,400	43.6	309.9	113,500	192,500	205
210	36.8	290.3	119,500	161,100	38.9	296.4	115,300	180,100	41.8	304.2	109,100	186,500	210
215	34.6	283.0	114,900	155,700	36.8	289.7	110,900	173,100	39.9	298.2	104,800	180,800	215
220	32.3	275.2	110,600	150,600	34.6	282.4	106,700	166,500	37.8	291.8	100,800	175,400	220
230	27.2	256.9	102,500	141,800	29.9	265.9	98,800	154,000	33.5	277.3	93,200	163,700	230
240	20.9	233.3	94,900	125,900	24.3	245.4	91,400	139,300	28.6	259.9	86,100	151,400	240
250	11.5	196.2	87,600	94,800	16.9	217.2	84,500	116,200	22.7	238.0	79,600	138,500	250
260									14.4	206.2	73,300	115,000	260
270													270
280													280
290													290
300													300

# MLC650 VPC-MAX S-2

ASME B30.5

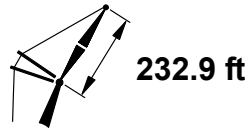
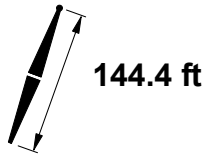

ft	75°				70°				65°				ft
	ft	°	ft	lb	ft	°	ft	lb	ft	°	ft	lb	
90													90
95													95
100													100
105													105
110													110
115													115
120													120
125													125
130													130
135													135
140													140
145													145
150	64.5	357.6	167,000	235,700									150
155	63.1	355.1	159,300	235,700									155
160	61.7	352.3	152,100	235,700									160
165	60.3	349.4	145,300	235,700									165
170	58.8	346.4	138,900	235,100									170
175	57.4	343.1	132,900	226,500									175
180	55.9	339.7	127,200	218,500	59.4	343.5	115,300	209,500					180
185	54.3	336.0	121,800	211,000	57.9	340.3	110,200	202,200					185
190	52.8	332.2	116,700	203,800	56.5	337.0	105,500	195,300					190
195	51.2	328.1	111,900	197,000	54.9	333.4	101,000	188,800					195
200	49.6	323.8	107,300	190,600	53.4	329.7	96,700	182,600					200
205	47.9	319.3	102,900	184,500	51.8	325.7	92,600	176,700					205
210	46.2	314.5	98,800	178,700	50.2	321.5	88,700	171,100	53.9	325.8	78,800	163,700	210
215	44.5	309.3	94,800	173,200	48.6	317.0	85,000	165,800	52.3	321.9	75,400	158,500	215
220	42.6	303.9	91,000	167,900	46.9	312.3	81,400	160,700	50.7	317.8	72,100	153,600	220
230	38.8	291.8	83,900	158,100	43.4	302.0	74,800	151,200	47.4	308.7	65,900	144,500	230
240	34.5	277.8	77,300	149,100	39.6	290.2	68,700	142,500	43.9	298.6	60,200	136,100	240
250	29.8	261.2	71,300	140,800	35.4	276.6	63,000	134,500	40.2	287.1	54,900	128,300	250
260	24.1	240.5	65,600	133,100	30.8	260.6	57,700	127,100	36.1	273.8	50,000	121,200	260
270	16.7	212.0	60,100	125,900	25.3	241.0	52,700	120,200	31.5	258.3	45,400	114,600	270
280					18.4	214.6	48,000	113,800	26.3	239.3	41,100	108,400	280
290					5.0	161.4	43,000	107,500	19.7	214.4	36,900	102,600	290
300									8.8	171.6	32,700	97,100	300

# MLC650 VPC-MAX S-2

ASME B30.5



661,300 lb

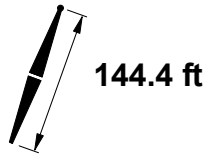

144.4 ft

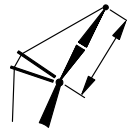

252.6 ft

ft	85°				83°				80°				ft
	ft	lb	lb	lb	ft	lb	lb	lb	ft	lb	lb	lb	
95	73.9	395.8	228,400	228,400									95
100	72.7	394.2	227,700	227,700									100
105	71.5	392.5	226,900	226,900	72.8	393.6	224,200	224,200					105
110	70.3	390.7	226,000	226,000	71.6	391.9	223,900	223,900					110
115	69.1	388.8	225,000	225,000	70.3	390.1	223,500	223,500					115
120	67.9	386.7	224,000	224,000	69.1	388.1	223,000	223,000					120
125	66.7	384.5	222,900	222,900	67.9	386.1	222,400	222,400	69.7	387.8	215,500	215,500	125
130	65.4	382.2	221,800	221,800	66.7	383.9	221,700	221,700	68.5	385.8	215,500	215,500	130
135	64.1	379.7	220,600	220,600	65.4	381.5	216,900	221,000	67.3	383.7	206,600	215,500	135
140	62.9	377.1	212,900	219,400	64.1	379.1	206,300	220,300	66.0	381.4	196,500	215,500	140
145	61.6	374.3	202,900	218,200	62.9	376.5	196,500	219,400	64.8	379.0	187,000	215,500	145
150	60.3	371.4	193,600	216,900	61.6	373.7	187,400	218,500	63.5	376.5	178,200	215,400	150
155	58.9	368.4	184,800	215,700	60.3	370.8	178,900	217,600	62.2	373.8	170,000	215,100	155
160	57.6	365.2	176,700	214,400	58.9	367.8	170,900	216,700	60.9	371.0	162,400	214,800	160
165	56.2	361.8	169,000	209,200	57.6	364.5	163,400	215,700	59.6	368.0	155,100	214,500	165
170	54.8	358.2	161,800	202,900	56.2	361.2	156,400	214,800	58.3	364.9	148,400	214,100	170
175	53.4	354.5	155,000	196,500	54.8	357.6	149,800	213,800	56.9	361.6	142,000	213,600	175
180	52.0	350.5	148,600	190,300	53.4	353.8	143,500	212,800	55.5	358.1	136,000	213,100	180
185	50.5	346.4	142,500	184,100	52.0	349.9	137,600	210,500	54.1	354.4	130,300	212,600	185
190	49.0	342.0	136,800	178,000	50.5	345.7	132,000	204,100	52.7	350.6	124,900	209,600	190
195	47.4	337.3	131,300	172,100	49.0	341.3	126,700	197,800	51.2	346.5	119,700	202,700	195
200	45.8	332.4	126,200	166,300	47.4	336.7	121,600	191,500	49.7	342.3	114,900	196,100	200
205	44.2	327.3	121,200	160,700	45.8	331.8	116,800	185,300	48.2	337.8	110,300	189,800	205
210	42.5	321.8	116,500	155,300	44.2	326.6	112,300	178,400	46.6	333.0	105,800	183,800	210
215	40.8	316.0	112,100	150,200	42.5	321.2	107,900	171,500	45.0	328.0	101,600	178,100	215
220	39.0	309.8	107,800	145,200	40.8	315.3	103,700	164,900	43.4	322.6	97,600	172,700	220
230	35.1	296.0	99,800	136,000	37.1	302.5	95,900	152,700	39.9	311.0	90,100	162,100	230
240	30.8	280.0	92,400	128,000	33.1	287.7	88,700	141,500	36.1	297.7	83,200	150,200	240
250	25.9	260.7	85,500	121,300	28.5	270.2	82,000	131,200	32.0	282.3	76,800	139,200	250
260	19.8	235.7	79,100	105,200	23.1	248.6	75,800	117,800	27.2	264.0	70,800	129,100	260
270	10.5	196.1	72,800	77,900	15.9	218.7	69,800	97,000	21.5	240.8	65,200	117,400	270
280									13.5	207.0	59,800	96,200	280
290													290
300													300
310													310
320													320

# MLC650 VPC-MAX S-2

ASME B30.5

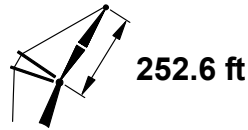
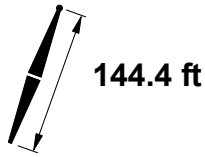

ft	75°				70°				65°				ft
	ft	°	ft	lb	ft	°	ft	lb	ft	°	ft	lb	
95													95
100													100
105													105
110													110
115													115
120													120
125													125
130													130
135													135
140													140
145													145
150													150
155													155
160	64.1	374.6	148,200	199,400									160
165	62.8	372.0	141,500	199,400									165
170	61.5	369.3	135,100	199,400									170
175	60.2	366.4	129,100	199,400									175
180	58.9	363.3	123,500	199,400									180
185	57.5	360.1	118,200	199,400									185
190	56.2	356.7	113,100	199,400	59.4	360.5	101,600	183,300					190
195	54.8	353.1	108,300	194,000	58.1	357.3	97,100	183,300					195
200	53.3	349.4	103,700	187,600	56.7	354.0	92,800	179,400					200
205	51.9	345.4	99,400	181,600	55.3	350.5	88,800	173,600					205
210	50.4	341.2	95,300	175,800	53.9	346.8	84,900	168,000					210
215	48.9	336.8	91,300	170,300	52.5	342.9	81,200	162,700					215
220	47.4	332.2	87,600	165,100	51.0	338.8	77,700	157,600	54.4	342.9	68,100	150,500	220
230	44.1	322.1	80,500	155,300	48.0	330.0	71,200	148,200	51.5	335.0	62,000	141,400	230
240	40.7	310.8	74,100	146,300	44.8	320.1	65,100	139,600	48.5	326.3	56,400	133,000	240
250	37.0	297.9	68,100	138,100	41.4	309.0	59,500	131,600	45.3	316.6	51,200	125,400	250
260	33.0	283.1	62,500	130,500	37.8	296.5	54,400	124,300	42.0	305.8	46,400	118,300	260
270	28.4	265.5	57,300	123,500	33.8	282.1	49,500	117,500	38.4	293.5	41,900	111,800	270
280	22.9	243.7	52,400	116,900	29.3	265.2	45,000	111,200	34.4	279.4	37,700	105,700	280
290	15.7	213.5	47,700	110,100	24.1	244.4	40,700	105,300	30.1	262.9	33,700	100,000	290
300					17.4	216.5	36,600	99,700	25.0	242.9	30,000	94,700	300
310					3.5	156.2	32,100	90,900	18.6	216.5	26,400	89,700	310
320									7.9	170.4	22,600	84,800	320

# MLC650 VPC-MAX S-2

ASME B30.5

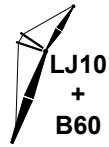

661,300 lb

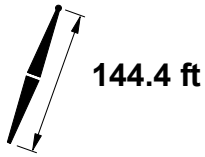

144.4 ft



272.3 ft

ft	85°				83°				80°				ft
	ft	lb	lb	lb	ft	lb	lb	lb	ft	lb	lb	lb	
100	74.0	414.9	195,600	195,600									100
105	72.9	413.3	194,900	194,900									105
110	71.8	411.6	194,100	194,100	72.9	412.7	192,300	192,300					110
115	70.7	409.8	193,300	193,300	71.8	411.0	191,900	191,900					115
120	69.6	407.9	192,300	192,300	70.7	409.2	191,400	191,400					120
125	68.4	405.9	191,400	191,400	69.6	407.3	190,800	190,800					125
130	67.3	403.8	190,300	190,300	68.5	405.3	190,200	190,200					130
135	66.1	401.6	189,300	189,300	67.3	403.2	189,500	189,500	69.0	405.0	184,800	184,800	135
140	65.0	399.2	188,200	188,200	66.2	400.9	188,700	188,700	67.9	403.0	184,700	184,700	140
145	63.8	396.7	187,100	187,100	65.0	398.6	187,900	187,900	66.7	400.8	184,500	184,500	145
150	62.6	394.1	186,000	186,000	63.8	396.1	185,300	187,100	65.6	398.5	175,900	184,300	150
155	61.4	391.3	182,900	184,800	62.6	393.4	176,800	186,300	64.4	396.0	167,700	184,000	155
160	60.2	388.4	174,700	183,700	61.4	390.7	168,800	185,400	63.2	393.5	160,100	183,600	160
165	59.0	385.4	167,100	182,500	60.2	387.8	161,400	184,500	62.0	390.8	152,900	183,200	165
170	57.7	382.2	159,900	181,300	59.0	384.7	154,400	183,600	60.8	387.9	146,200	182,700	170
175	56.5	378.8	153,100	180,200	57.7	381.5	147,800	182,600	59.6	385.0	139,800	182,200	175
180	55.2	375.3	146,700	177,100	56.5	378.2	141,500	181,700	58.3	381.8	133,800	181,700	180
185	53.9	371.6	140,700	172,200	55.2	374.7	135,600	180,700	57.1	378.6	128,100	181,100	185
190	52.5	367.7	134,900	167,200	53.9	371.0	130,100	179,800	55.8	375.1	122,800	180,600	190
195	51.2	363.7	129,500	162,300	52.5	367.1	124,800	178,900	54.5	371.5	117,700	180,000	195
200	49.8	359.4	124,400	157,400	51.2	363.0	119,700	178,000	53.2	367.8	112,800	179,400	200
205	48.4	354.9	119,500	152,600	49.8	358.8	115,000	174,300	51.9	363.8	108,200	178,800	205
210	46.9	350.2	114,800	147,900	48.4	354.3	110,400	169,300	50.5	359.6	103,800	178,200	210
215	45.5	345.3	110,400	143,400	46.9	349.6	106,100	164,400	49.1	355.3	99,700	176,300	215
220	43.9	340.0	106,100	139,000	45.5	344.6	101,900	159,500	47.7	350.7	95,700	170,900	220
230	40.8	328.7	98,200	130,500	42.4	333.9	94,200	150,100	44.7	340.8	88,200	160,900	230
240	37.3	316.0	90,800	122,800	39.1	321.9	87,000	141,100	41.6	329.7	81,400	149,600	240
250	33.6	301.4	84,100	115,800	35.5	308.3	80,500	131,000	38.2	317.4	75,000	138,800	250
260	29.5	284.6	77,800	109,700	31.6	292.7	74,400	121,600	34.6	303.3	69,200	128,900	260
270	24.7	264.2	72,000	104,500	27.2	274.3	68,700	112,800	30.6	287.1	63,700	119,700	270
280	18.8	238.0	66,400	88,400	22.0	251.5	63,300	100,300	26.0	267.8	58,600	111,100	280
290	9.7	195.7	61,000	64,100	15.0	219.9	58,100	81,300	20.5	243.4	53,700	100,200	290
300									12.6	207.6	49,000	80,800	300
310													310
320													320
330													330
340													340



# MLC650 VPC-MAX S-2

ASME B30.5

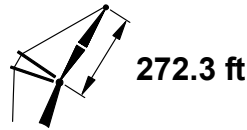
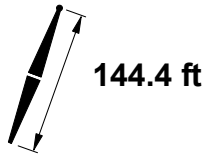
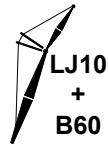

ft	75°				70°				65°				ft
	ft	°	ft	lb	ft	°	ft	lb	ft	°	ft	lb	
100													100
105													105
110													110
115													115
120													120
125													125
130													130
135													135
140													140
145													145
150													150
155													155
160													160
165	64.9	394.1	139,000	170,900									165
170	63.8	391.6	132,600	170,900									170
175	62.6	389.0	126,700	170,900									175
180	61.4	386.2	121,100	170,900									180
185	60.1	383.3	115,800	170,900									185
190	58.9	380.3	110,700	170,900									190
195	57.7	377.1	106,000	170,900									195
200	56.4	373.7	101,400	170,900	59.4	377.4	90,300	157,800					200
205	55.1	370.2	97,100	170,900	58.2	374.3	86,300	157,800					205
210	53.8	366.5	93,000	170,900	56.9	371.0	82,400	157,800					210
215	52.5	362.6	89,100	168,400	55.6	367.5	78,800	157,800					215
220	51.1	358.5	85,400	163,200	54.3	363.9	75,300	155,600					220
230	48.3	349.8	78,400	153,500	51.7	356.1	68,800	146,200	54.7	360.0	59,400	139,200	230
240	45.4	340.1	72,000	144,600	48.9	347.5	62,800	137,600	52.1	352.3	53,900	131,000	240
250	42.3	329.3	66,100	136,400	46.0	338.0	57,300	129,800	49.3	343.8	48,700	123,400	250
260	39.0	317.3	60,600	128,900	42.9	327.5	52,200	122,500	46.4	334.5	44,000	116,300	260
270	35.5	303.7	55,500	121,900	39.7	315.7	47,400	115,800	43.4	324.1	39,600	109,900	270
280	31.5	288.0	50,800	115,400	36.2	302.5	43,000	109,500	40.2	312.6	35,500	103,800	280
290	27.1	269.5	46,300	109,300	32.4	287.3	38,900	103,700	36.7	299.6	31,600	98,200	290
300	21.9	246.6	42,000	103,700	28.0	269.4	35,000	98,300	33.0	284.7	28,000	93,000	300
310	14.8	214.7	37,900	94,000	23.0	247.5	31,200	93,100	28.8	267.3	24,600	88,100	310
320					16.4	218.1	27,600	88,300	23.9	246.2	21,300	83,400	320
330									17.6	218.5		79,000	330
340									6.9	168.7		74,700	340

# MLC650 VPC-MAX S-2

ASME B30.5



661,300 lb

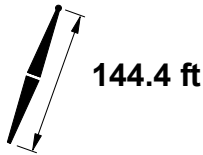

144.4 ft

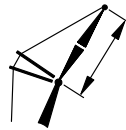

292.0 ft

ft	85°				83°				80°				ft
	ft	lb	lb	lb	ft	lb	lb	lb	ft	lb	lb	lb	
105	74.1	433.9	163,900	163,900									105
110	73.1	432.4	163,100	163,100									110
115	72.1	430.7	162,300	162,300									115
120	71.0	429.0	161,400	161,400	72.1	430.1	160,300	160,300					120
125	70.0	427.1	160,500	160,500	71.0	428.3	159,700	159,700					125
130	68.9	425.2	159,500	159,500	70.0	426.5	159,000	159,000					130
135	67.9	423.1	158,500	158,500	68.9	424.5	158,300	158,300					135
140	66.8	420.9	157,500	157,500	67.9	422.5	157,500	157,500	69.4	424.2	153,900	153,900	140
145	65.7	418.6	156,500	156,500	66.8	420.3	156,700	156,700	68.4	422.2	153,600	153,600	145
150	64.6	416.2	155,500	155,500	65.7	418.0	155,900	155,900	67.3	420.1	153,200	153,200	150
155	63.5	413.7	154,400	154,400	64.6	415.6	155,100	155,100	66.2	417.8	152,800	152,800	155
160	62.4	411.0	153,400	153,400	63.5	413.0	154,200	154,200	65.2	415.5	152,300	152,300	160
165	61.3	408.3	152,300	152,300	62.4	410.4	153,400	153,400	64.1	413.0	149,100	151,800	165
170	60.2	405.4	151,300	151,300	61.3	407.6	150,700	152,500	63.0	410.4	142,300	151,300	170
175	59.0	402.3	149,600	150,200	60.2	404.7	144,100	151,600	61.9	407.7	136,000	150,700	175
180	57.8	399.1	143,200	149,200	59.0	401.7	137,900	150,700	60.7	404.9	130,000	150,100	180
185	56.7	395.8	137,100	148,100	57.8	398.5	132,000	149,800	59.6	401.9	124,300	149,500	185
190	55.5	392.3	131,400	147,100	56.7	395.2	126,400	148,900	58.4	398.8	119,000	148,900	190
195	54.3	388.7	126,000	146,100	55.5	391.7	121,200	148,100	57.3	395.6	113,900	148,300	195
200	53.0	384.9	120,900	145,100	54.3	388.1	116,200	147,200	56.1	392.2	109,100	147,600	200
205	51.8	380.9	116,000	143,500	53.0	384.3	111,400	146,300	54.9	388.6	104,500	147,000	205
210	50.5	376.8	111,300	139,700	51.8	380.3	106,900	145,500	53.6	384.9	100,100	146,400	210
215	49.2	372.4	106,900	136,000	50.5	376.1	102,500	144,600	52.4	381.0	96,000	145,700	215
220	47.9	367.9	102,700	132,200	49.2	371.8	98,400	143,800	51.1	376.9	92,000	145,100	220
230	45.1	358.1	94,800	125,000	46.5	362.5	90,700	142,300	48.5	368.2	84,600	143,900	230
240	42.2	347.3	87,500	118,100	43.7	352.2	83,600	134,900	45.8	358.7	77,800	142,700	240
250	39.2	335.3	80,800	111,600	40.7	340.8	77,100	127,700	43.0	348.2	71,500	136,800	250
260	35.9	321.9	74,600	105,500	37.6	328.2	71,000	119,700	40.0	336.5	65,700	126,900	260
270	32.3	306.6	68,800	100,100	34.1	313.9	65,400	111,200	36.7	323.4	60,300	117,900	270
280	28.3	288.9	63,400	95,200	30.4	297.5	60,200	103,200	33.2	308.7	55,300	109,400	280
290	23.7	267.5	58,300	87,700	26.1	278.2	55,200	95,600	29.4	291.6	50,500	101,600	290
300	17.9	240.0	53,500	72,500	21.0	254.2	50,500	83,900	24.9	271.4	46,100	94,100	300
310	8.9	195.0	48,700	50,500	14.2	221.0	46,000	66,200	19.5	245.8	41,800	83,900	310
320									11.9	208.0	37,600	65,900	320
330													330
340													340
350													350
360													360

# MLC650 VPC-MAX S-2

ASME B30.5

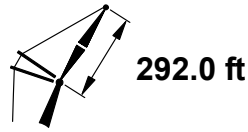
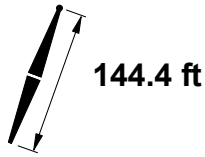

ft	75°				70°				65°				ft
	ft	°	ft	lb	ft	°	ft	lb	ft	°	ft	lb	
105													105
110													110
115													115
120													120
125													125
130													130
135													135
140													140
145													145
150													150
155													155
160													160
165													165
170													170
175	64.6	411.2	122,600	141,800									175
180	63.5	408.6	117,000	141,800									180
185	62.4	406.0	111,700	141,800									185
190	61.2	403.2	106,700	141,800									190
195	60.1	400.3	102,000	141,800									195
200	59.0	397.2	97,500	141,800									200
205	57.8	394.1	93,200	141,800									205
210	56.6	390.7	89,100	141,800	59.4	394.4	78,300	130,300					210
215	55.4	387.2	85,200	141,700	58.3	391.3	74,700	130,300					215
220	54.2	383.6	81,500	141,600	57.1	388.0	71,200	130,300					220
230	51.7	375.8	74,600	141,200	54.7	381.0	64,700	130,300					230
240	49.1	367.3	68,200	140,800	52.2	373.3	58,800	130,300					240
250	46.5	357.9	62,300	133,400	49.7	365.0	53,300	126,600	52.6	369.5	44,600	120,100	250
260	43.6	347.6	56,900	125,900	47.0	355.8	48,300	119,400	50.1	361.2	39,900	113,100	260
270	40.7	336.3	51,900	118,900	44.2	345.7	43,600	112,700	47.4	352.2	35,500	106,700	270
280	37.5	323.5	47,200	112,500	41.3	334.5	39,200	106,500	44.7	342.2	31,500	100,700	280
290	34.1	309.2	42,800	106,500	38.1	322.1	35,100	100,700	41.7	331.3	27,700	95,100	290
300	30.3	292.8	38,600	100,900	34.8	308.1	31,300	95,300	38.6	319.1	24,100	90,000	300
310	26.0	273.4	34,700	95,600	31.1	292.1	27,700	90,300	35.3	305.3	20,800	85,100	310
320	20.9	249.3	31,000	89,200	26.9	273.4	24,200	85,500	31.7	289.7		80,500	320
330	14.0	215.7	27,300	78,600	22.0	250.5	21,000	81,000	27.6	271.5		76,200	330
340					15.6	219.6		76,700	22.8	249.4		72,100	340
350									16.8	220.2		68,200	350
360									6.0	166.4		64,400	360

# MLC650 VPC-MAX S-2

ASME B30.5



661,300 lb

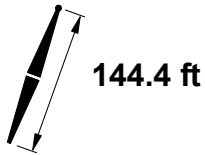

144.4 ft



311.7 ft

ft	85°				83°				80°				ft
	ft	lb	lb	lb	ft	lb	lb	lb	ft	lb	lb	lb	
110	74.2	453.0	140,300	140,300									110
115	73.2	451.4	139,500	139,500									115
120	72.3	449.8	138,700	138,700									120
125	71.3	448.1	137,900	137,900	72.3	449.2	137,000	137,000					125
130	70.3	446.3	137,000	137,000	71.3	447.5	136,400	136,400					130
135	69.3	444.3	136,100	136,100	70.3	445.6	135,700	135,700					135
140	68.3	442.3	135,200	135,200	69.3	443.7	135,000	135,000					140
145	67.3	440.2	134,300	134,300	68.3	441.7	134,300	134,300	69.8	443.4	131,300	131,300	145
150	66.3	438.0	133,400	133,400	67.3	439.6	133,500	133,500	68.8	441.4	130,900	130,900	150
155	65.3	435.7	132,400	132,400	66.3	437.4	132,700	132,700	67.8	439.4	130,500	130,500	155
160	64.3	433.2	131,500	131,500	65.3	435.0	132,000	132,000	66.8	437.2	130,000	130,000	160
165	63.3	430.7	130,500	130,500	64.3	432.6	131,200	131,200	65.8	434.9	129,500	129,500	165
170	62.2	428.0	129,600	129,600	63.3	430.0	130,300	130,300	64.8	432.5	129,000	129,000	170
175	61.2	425.2	128,600	128,600	62.2	427.4	129,500	129,500	63.8	430.0	128,400	128,400	175
180	60.1	422.3	127,800	127,800	61.2	424.6	128,800	128,800	62.7	427.4	127,800	127,900	180
185	59.0	419.3	126,800	126,800	60.1	421.7	127,900	127,900	61.7	424.7	122,200	127,300	185
190	57.9	416.1	125,800	125,800	59.0	418.6	124,400	127,100	60.6	421.8	116,800	126,700	190
195	56.8	412.8	124,100	124,900	58.0	415.5	119,200	126,300	59.6	418.9	111,800	126,100	195
200	55.7	409.4	119,000	124,000	56.9	412.2	114,200	125,500	58.5	415.8	107,000	125,500	200
205	54.6	405.8	114,100	123,100	55.7	408.7	109,400	124,700	57.4	412.5	102,400	124,900	205
210	53.5	402.0	109,500	122,300	54.6	405.2	104,900	123,900	56.3	409.2	98,100	124,300	210
215	52.3	398.1	105,100	121,400	53.5	401.4	100,600	123,100	55.2	405.7	93,900	123,700	215
220	51.1	394.1	100,800	120,500	52.3	397.5	96,500	122,300	54.0	402.0	90,000	123,000	220
230	48.7	385.4	92,900	117,000	49.9	389.2	88,800	120,900	51.7	394.2	82,600	121,900	230
240	46.1	375.9	85,700	111,200	47.4	380.2	81,700	119,400	49.3	385.7	75,800	120,700	240
250	43.5	365.6	79,000	105,400	44.8	370.3	75,200	118,100	46.8	376.5	69,500	119,600	250
260	40.7	354.2	72,900	100,000	42.1	359.4	69,200	114,000	44.2	366.3	63,800	118,600	260
270	37.7	341.6	67,200	94,900	39.3	347.4	63,700	108,300	41.4	355.2	58,400	116,900	270
280	34.6	327.5	61,800	90,200	36.2	334.1	58,500	102,500	38.5	342.9	53,400	108,600	280
290	31.1	311.5	56,800	85,800	32.9	319.1	53,600	95,200	35.4	329.2	48,800	100,900	290
300	27.2	292.9	52,100	82,000	29.2	302.0	49,000	88,300	32.0	313.8	44,400	93,700	300
310	22.7	270.7	47,700	74,100	25.1	281.8	44,700	81,200	28.2	295.9	40,300	86,900	310
320	17.1	241.8	43,400	60,000	20.1	256.8	40,600	70,700	23.9	274.8	36,400	80,500	320
330	8.1	193.9	39,100	39,900	13.5	221.9	36,600	54,500	18.7	248.0	32,600	70,900	330
340									11.1	208.1	28,900	54,200	340
350													350
360													360
370													370
380													380

# MLC650 VPC-MAX S-2

ASME B30.5

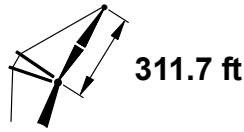
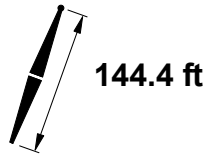
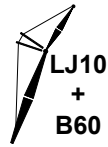

ft	75°				70°				65°					
	ft	°	ft	lb	ft	°	ft	lb	ft	°	ft	lb	ft	
110														110
115														115
120														120
125														125
130														130
135														135
140														140
145														145
150														150
155														155
160														160
165														165
170														170
175														175
180														180
185	64.3	428.2	109,300	120,400										185
190	63.2	425.6	104,300	120,300										190
195	62.2	422.9	99,600	120,300										195
200	61.1	420.2	95,100	120,200										200
205	60.1	417.2	90,900	120,000										205
210	59.0	414.2	86,800	119,900										210
215	57.9	411.0	82,900	119,700										215
220	56.8	407.7	79,200	119,500	59.4	411.3	68,700	110,200						220
230	54.6	400.7	72,300	119,000	57.2	405.0	62,300	110,200						230
240	52.2	393.0	66,000	118,500	55.0	398.1	56,400	110,200						240
250	49.8	384.7	60,200	118,000	52.7	390.5	51,000	110,200						250
260	47.4	375.6	54,800	117,500	50.3	382.3	46,000	110,200	53.1	386.7	101,300			260
270	44.8	365.7	49,800	117,000	47.9	373.4	41,300	110,200	50.7	378.6	101,300			270
280	42.1	354.8	45,100	110,800	45.3	363.7	37,000	104,700	48.3	369.8	98,800			280
290	39.2	342.8	40,800	104,800	42.6	353.0	33,000	98,900	45.7	360.2	93,200			290
300	36.1	329.5	36,700	99,300	39.8	341.2	29,200	93,600	43.0	349.7	88,100			300
310	32.8	314.5	32,900	94,000	36.7	328.2	25,600	88,600	40.2	338.1	83,300			310
320	29.1	297.2	29,300	88,900	33.5	313.5	22,300	83,900	37.2	325.2	78,700			320
330	25.0	277.0	25,800	82,400	29.9	296.8		79,400	34.0	310.8	74,500			330
340	20.0	251.8	22,500	76,200	25.9	277.2		75,200	30.5	294.5	70,500			340
350	13.3	216.5		66,400	21.1	253.2		71,300	26.5	275.4	66,700			350
360					14.8	220.8		67,500	21.9	252.3	63,000			360
370									16.0	221.8	59,600			370
380									5.1	163.3	56,100			380

# MLC650 VPC-MAX S-2

ASME B30.5

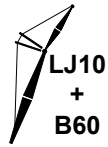

661,300 lb

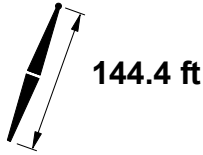

144.4 ft



331.4 ft

ft	85°				83°				80°				ft
	ft	lb	lb	lb	ft	lb	lb	lb	ft	lb	lb	lb	
115	74.3	472.0	119,600	119,600									115
120	73.4	470.5	119,000	119,000									120
125	72.4	468.9	118,300	118,300									125
130	71.5	467.2	117,500	117,500	72.5	468.3	116,800	116,800					130
135	70.6	465.4	116,600	116,600	71.5	466.6	116,100	116,100					135
140	69.7	463.5	115,700	115,700	70.6	464.8	115,400	115,400					140
145	68.8	461.6	114,900	114,900	69.7	462.9	114,700	114,700					145
150	67.8	459.5	114,000	114,000	68.8	460.9	113,900	113,900					150
155	66.9	457.3	113,100	113,100	67.8	458.9	113,200	113,200	69.2	460.6	111,000	111,000	155
160	65.9	455.1	112,200	112,200	66.9	456.7	112,400	112,400	68.3	458.6	110,500	110,500	160
165	65.0	452.7	111,300	111,300	65.9	454.4	111,700	111,700	67.4	456.5	110,000	110,000	165
170	64.0	450.2	110,500	110,500	65.0	452.1	110,900	110,900	66.4	454.3	109,500	109,500	170
175	63.0	447.6	109,600	109,600	64.0	449.6	110,200	110,200	65.5	452.0	108,900	108,900	175
180	62.1	445.0	108,700	108,700	63.0	447.0	109,400	109,400	64.5	449.5	108,400	108,400	180
185	61.1	442.2	107,900	107,900	62.1	444.3	108,600	108,600	63.5	447.0	107,800	107,800	185
190	60.1	439.3	107,000	107,000	61.1	441.5	107,900	107,900	62.6	444.4	107,300	107,300	190
195	59.1	436.2	106,200	106,200	60.1	438.6	107,100	107,100	61.6	441.7	106,700	106,700	195
200	58.0	433.1	105,400	105,400	59.1	435.6	106,400	106,400	60.6	438.8	103,300	106,100	200
205	57.0	429.8	104,500	104,500	58.0	432.5	105,700	105,700	59.6	435.8	98,800	105,600	205
210	56.0	426.4	103,700	103,700	57.0	429.2	104,900	104,900	58.6	432.7	94,400	105,000	210
215	54.9	422.8	101,700	102,900	56.0	425.8	97,100	104,200	57.5	429.5	90,300	104,400	215
220	53.8	419.2	97,500	102,100	54.9	422.2	93,000	103,500	56.5	426.2	86,400	103,800	220
230	51.6	411.3	89,600	100,600	52.7	414.7	85,300	102,100	54.4	419.1	79,000	102,700	230
240	49.4	402.9	82,400	99,200	50.5	406.6	78,300	100,700	52.2	411.4	72,200	101,500	240
250	47.0	393.7	75,700	97,700	48.2	397.7	71,800	99,400	49.9	403.1	66,000	100,400	250
260	44.6	383.7	69,600	93,100	45.8	388.2	65,800	98,200	47.6	394.1	60,300	99,400	260
270	42.0	372.8	63,900	88,600	43.3	377.7	60,300	97,100	45.2	384.3	55,000	98,500	270
280	39.3	360.8	58,600	84,400	40.7	366.3	55,100	94,400	42.7	373.7	50,000	97,600	280
290	36.5	347.6	53,700	80,300	37.9	353.8	50,300	87,900	40.0	362.0	45,400	95,500	290
300	33.4	332.9	49,000	76,300	34.9	339.8	45,800	81,400	37.2	349.1	41,100	88,900	300
310	30.0	316.2	44,700	70,000	31.7	324.2	41,600	74,900	34.2	334.8	37,000	82,300	310
320	26.2	296.8	40,500	63,700	28.2	306.3	37,600	68,600	30.9	318.6	33,100	75,700	320
330	21.9	273.6	36,600	57,700	24.2	285.2	33,800	62,200	27.2	300.0	29,500	69,100	330
340	16.4	243.4	32,800	47,400	19.3	259.1	30,100	56,200	23.0	277.9	26,000	62,600	340
350	7.4	192.6	28,900	28,900	12.8	222.5	26,500	42,400	17.9	250.0	22,700	56,500	350
360									10.4	208.1		42,300	360
370													370
380													380
390													390
400													400

# MLC650 VPC-MAX S-2

ASME B30.5

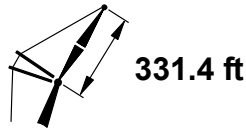
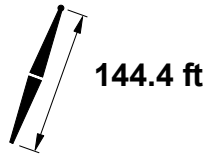

ft	75°				70°				65°					
	ft	°	ft	lb	ft	°	ft	lb	ft	°	ft	lb	ft	
115														115
120														120
125														125
130														130
135														135
140														140
145														145
150														150
155														155
160														160
165														165
170														170
175														175
180														180
185														185
190	64.9	447.6	100,400	101,400										190
195	64.0	445.2	95,700	101,200										195
200	63.0	442.6	91,300	101,100										200
205	62.0	439.9	87,000	100,900										205
210	61.0	437.1	83,000	100,800										210
215	60.0	434.2	79,100	100,500										215
220	59.0	431.2	75,400	100,300										220
230	57.0	424.7	68,500	99,800	59.4	428.3	58,300	92,200						230
240	54.9	417.8	62,200	99,200	57.4	422.0	52,500	92,200						240
250	52.7	410.2	56,400	98,700	55.3	415.1	47,100	92,200						250
260	50.5	402.1	51,100	98,100	53.1	407.7	42,100	92,200						260
270	48.2	393.2	46,100	97,500	50.9	399.7	37,500	92,200	53.5	403.8	84,200			270
280	45.8	383.6	41,500	97,000	48.6	391.0	33,200	92,200	51.3	395.9	84,200			280
290	43.3	373.2	37,200	96,500	46.2	381.5	29,200	92,200	49.0	387.3	84,200			290
300	40.6	361.7	33,200	96,100	43.8	371.2	25,500	90,700	46.6	378.0	84,200			300
310	37.8	349.2	29,400	91,300	41.2	360.0	21,900	85,700	44.2	367.8	80,300			310
320	34.9	335.2	25,800	86,400	38.4	347.7		81,000	41.6	356.8	75,800			320
330	31.7	319.5	22,500	80,200	35.5	334.0		76,600	38.9	344.6	71,600			330
340	28.1	301.5		73,500	32.3	318.7		72,500	36.0	331.2	67,600			340
350	24.1	280.4		66,900	28.8	301.2		68,600	32.8	316.1	63,800			350
360	19.2	254.1		60,500	24.9	280.8		64,800	29.4	299.0	60,200			360
370	12.6	217.1		53,900	20.2	255.8		61,300	25.6	279.2	56,900			370
380					14.1	221.9		57,900	21.0	255.1	53,600			380
390									15.3	223.1	50,500			390
400									4.0	159.1	47,300			400

# MLC650 VPC-MAX S-2

ASME B30.5

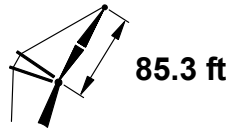
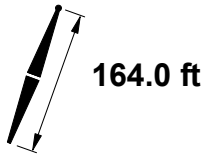
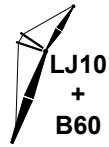

ft	85°				83°				80°				ft
	ft	ft	lb	lb	ft	lb	lb	ft	lb	lb	ft		
50	74.2	254.8	714,000 c	771,600 c									50
55	70.6	252.9	638,400 c	771,600 c									55
60	67.0	250.7	576,500 c	771,600 c	71.1	252.5	561,100 c	771,600 c					60
65	63.2	248.0	524,800 b	758,000 b	67.5	250.3	510,700 b	771,600 b					65
70	59.2	244.9	480,900 b	727,000 b	63.7	247.7	468,100 b	761,700 b					70
75	55.1	241.3	443,300	697,900	59.8	244.7	431,400 b	708,400 b	66.4	248.1	413,600 b	694,000 b	75
80	50.7	237.1	410,600	664,400	55.7	241.1	399,600	655,400	62.5	245.4	383,100 b	642,100 b	80
85	46.0	232.2	381,800	617,900	51.3	237.0	371,600	609,500	58.6	242.2	356,300 b	597,000 b	85
90	40.8	226.3	356,300	577,100	46.7	232.2	346,900	569,300	54.4	238.5	332,600	557,600	90
95	34.9	219.1	333,500	518,000	41.6	226.5	324,800	533,700	50.0	234.2	311,400	522,800	95
100	27.9	209.9	312,900	435,900	35.8	219.5	304,800	502,100	45.2	229.2	292,400	491,900	100
105	18.1	196.2	293,800	352,600	29.0	210.7	286,700	462,000	39.9	223.1	275,200	464,100	105
110					19.8	197.9	269,800	377,300	33.9	215.7	259,400	439,100	110
115									26.6	206.0	244,900	416,300	115
120									15.9	190.8	231,100	367,900	120
125													125
130													130
135													135
140													140
145													145
150													150
155													155
160													160



# MLC650 VPC-MAX S-2

ASME B30.5

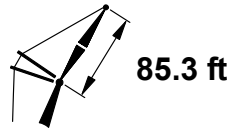
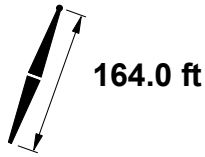
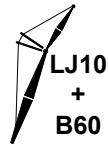

ft	75°				70°				65°				ft
	ft	°	ft	lb	ft	°	ft	lb	ft	°	ft	lb	
50													50
55													55
60													60
65													65
70													70
75													75
80													80
85													85
90													90
95	61.7	241.4	289,000 b	505,000 b									95
100	57.7	238.1	271,300	475,000									100
105	53.5	234.3	255,400	448,200									105
110	49.0	229.9	240,900	424,100									110
115	44.1	224.6	227,600	402,200	56.6	232.5	209,900	388,300					115
120	38.7	218.3	215,400	382,300	52.3	228.6	198,700	369,100					120
125	32.5	210.5	204,100	364,000	47.7	223.9	188,400	351,500					125
130	24.8	200.1	193,400	347,200	42.7	218.4	178,700	335,300					130
135	12.2	182.1	182,900	331,400	37.1	211.7	169,800	320,400	50.6	221.2	155,500	309,300	135
140					30.6	203.4	161,300	306,600	45.9	216.2	147,900	296,000	140
145					22.1	191.8	153,200	293,600	40.7	210.3	140,700	283,600	145
150									34.9	203.2	133,900	272,100	150
155									27.8	193.9	127,400	261,300	155
160									17.9	180.0	120,900	251,000	160

# MLC650 VPC-MAX S-2

ASME B30.5

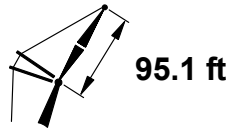
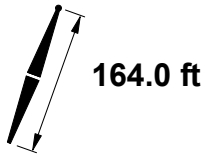

ft	85°				83°				80°				ft
	ft	lb	lb	lb	ft	lb	lb	lb	ft	lb	lb	lb	
55	72.7	263.5	636,000 c	771,600 c									55
60	69.5	261.5	574,100 b	762,900 b									60
65	66.2	259.2	522,500 b	733,600 b	70.0	261.1	508,100 b	771,600 b					65
70	62.8	256.5	478,800 b	705,000 b	66.7	258.8	465,600 b	750,800 b					70
75	59.2	253.4	441,200	677,600	63.3	256.2	429,000 b	705,200 b	69.0	259.0	410,800 b	690,500 b	75
80	55.6	249.9	408,600	651,800	59.8	253.2	397,300	652,400	65.7	256.6	380,300 b	638,800 b	80
85	51.7	245.8	380,000	615,200	56.1	249.7	369,500	606,700	62.2	253.9	353,700 b	594,000 b	85
90	47.6	241.1	354,700	574,600	52.2	245.7	344,800	566,600	58.7	250.7	330,100	554,800	90
95	43.1	235.7	332,100	538,800	48.2	241.1	322,900	531,300	55.0	247.1	309,000	520,200	95
100	38.3	229.3	311,800	506,900	43.8	235.8	303,200	499,800	51.0	243.0	290,200	489,300	100
105	32.7	221.6	293,300	463,700	39.0	229.6	285,300	471,600	46.9	238.2	273,100	461,700	105
110	26.0	211.6	276,500	394,100	33.5	222.1	269,000	446,200	42.4	232.6	257,600	436,900	110
115	16.6	196.8	260,600	321,400	27.0	212.5	254,100	417,500	37.4	226.0	243,400	414,300	115
120					18.2	198.7	240,000	344,000	31.7	218.0	230,300	393,800	120
125									24.7	207.6	218,100	374,900	125
130									14.4	191.1	206,300	335,400	130
135													135
140													140
145													145
150													150
155													155
160													160
165													165
170													170

# MLC650 VPC-MAX S-2

ASME B30.5

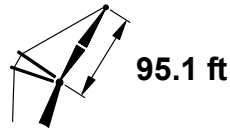
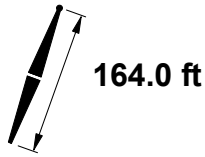
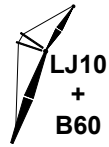

ft	75°				70°				65°				ft
	ft	ft	lb	lb	ft	ft	lb	lb	ft	ft	lb	lb	
55													55
60													60
65													65
70													70
75													75
80													80
85													85
90													90
95	64.9	252.7	285,900	501,900									95
100	61.5	249.9	268,400	472,200									100
105	57.9	246.6	252,600	445,500									105
110	54.2	242.9	238,200	421,500									110
115	50.2	238.6	225,100	399,700									115
120	46.0	233.7	213,100	379,900	56.9	241.1	195,700	366,400					120
125	41.4	228.0	202,000	361,800	53.1	237.2	185,500	348,900					125
130	36.3	221.1	191,700	345,200	49.1	232.8	176,000	332,900					130
135	30.4	212.7	182,000	329,800	44.7	227.6	167,300	318,100					135
140	23.0	201.5	172,900	315,500	40.0	221.6	159,000	304,400	51.6	229.9	144,900	293,400	140
145	10.7	181.7	163,700	302,000	34.8	214.4	151,300	291,700	47.5	225.2	137,900	281,200	145
150					28.6	205.4	144,000	279,800	43.1	219.8	131,300	269,800	150
155					20.5	192.9	136,900	268,600	38.2	213.4	125,000	259,100	155
160									32.6	205.6	119,100	249,100	160
165									25.9	195.6	113,400	239,700	165
170									16.4	180.6	107,700	230,700	170

# MLC650 VPC-MAX S-2

ASME B30.5

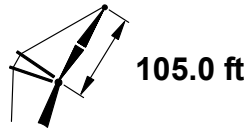
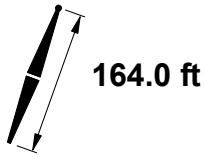

ft	85°				83°				80°				ft
	ft	lb	lb	lb	ft	lb	lb	lb	ft	lb	lb	lb	
55	74.4	273.9	634,700 b	747,300 b									55
60	71.5	272.1	572,900 b	733,000 b									60
65	68.6	270.0	521,300 b	709,600 b	71.9	271.6	506,700 b	740,100 b					65
70	65.6	267.7	477,700 b	683,700 b	69.0	269.6	464,200 b	727,500 b					70
75	62.5	265.0	440,200	658,300	66.0	267.3	427,800 b	700,700 b					75
80	59.3	261.9	407,700	634,100	62.9	264.6	396,100	650,300	68.1	267.5	378,800	636,500	80
85	55.9	258.4	379,200	611,100	59.7	261.6	368,400	604,700	65.1	265.1	352,200	591,900	85
90	52.5	254.5	353,900	573,000	56.4	258.2	343,900	564,900	62.0	262.3	328,700	552,900	90
95	48.8	250.0	331,500	537,300	53.0	254.3	322,000	529,700	58.7	259.2	307,800	518,400	95
100	44.9	244.9	311,300	505,500	49.3	250.0	302,400	498,300	55.4	255.7	289,000	487,700	100
105	40.7	239.0	293,100	477,000	45.5	245.0	284,700	470,300	51.9	251.6	272,100	460,200	105
110	36.1	232.2	276,500	451,400	41.3	239.2	268,600	445,000	48.2	247.1	256,700	435,500	110
115	30.8	223.8	261,300	416,000	36.8	232.5	253,900	422,100	44.3	241.9	242,700	413,000	115
120	24.4	213.2	247,200	359,000	31.6	224.4	240,400	401,200	40.0	235.9	229,800	392,600	120
125	15.2	197.2	233,900	294,800	25.4	214.2	227,800	380,100	35.3	228.8	217,900	373,900	125
130					16.9	199.4	215,800	315,500	29.9	220.2	206,800	356,800	130
135									23.2	209.0	196,400	340,900	135
140									13.1	191.2	186,200	307,300	140
145													145
150													150
155													155
160													160
165													165
170													170
175													175
180													180

# MLC650 VPC-MAX S-2

ASME B30.5

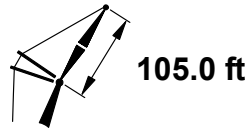
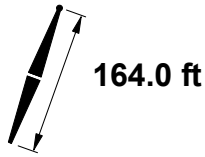
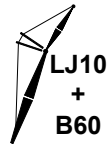

ft	75°				70°				65°				ft
	ft	ft	lb	lb	ft	ft	lb	lb	ft	ft	lb	lb	
55													55
60													60
65													65
70													70
75													75
80													80
85													85
90													90
95													95
100	64.4	261.2	266,800	470,200									100
105	61.3	258.3	251,100	443,700									105
110	58.1	255.1	236,800	419,800									110
115	54.7	251.5	223,800	398,200									115
120	51.2	247.4	211,900	378,500									120
125	47.4	242.7	200,900	360,500	57.1	249.6	183,900	347,300					125
130	43.4	237.3	190,700	343,900	53.7	245.8	174,600	331,300					130
135	39.1	231.1	181,300	328,700	50.1	241.5	165,900	316,600					135
140	34.2	223.8	172,500	314,600	46.3	236.7	157,800	303,000					140
145	28.6	214.7	164,200	301,400	42.3	231.1	150,300	290,400	52.4	238.5	136,300	279,700	145
150	21.5	202.7	156,200	289,200	37.8	224.6	143,200	278,700	48.8	234.1	129,800	268,400	150
155	9.4	181.1	148,200	277,500	32.8	216.9	136,400	267,700	44.9	229.0	123,700	257,800	155
160					26.8	207.2	130,000	257,400	40.7	223.1	118,000	247,900	160
165					19.0	193.8	123,800	247,700	36.0	216.2	112,500	238,700	165
170									30.7	207.8	107,300	229,900	170
175									24.3	197.1	102,200	221,600	175
180									15.1	181.0	97,100	213,700	180

# MLC650 VPC-MAX S-2

ASME B30.5



661,300 lb

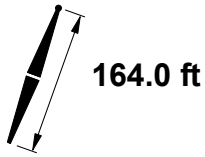

164.0 ft



114.8 ft

ft	85°				83°				80°				ft
	ft	lb	lb	lb	ft	lb	lb	lb	ft	lb	lb	lb	
60	73.2	282.5	570,400 b	680,200 b									60
65	70.5	280.7	518,900 b	667,600 b									65
70	67.8	278.6	475,300 b	654,700 b	70.9	280.3	461,600 b	674,800 b					70
75	65.0	276.2	437,900	637,700	68.2	278.2	425,200	663,800					75
80	62.2	273.4	405,400	615,400	65.4	275.8	393,600	647,200					80
85	59.3	270.4	376,900	593,800	62.6	273.1	365,900	601,800	67.4	276.1	349,400	588,800	85
90	56.3	266.9	351,800	570,300	59.7	270.1	341,500	562,100	64.6	273.6	326,000	549,900	90
95	53.1	263.1	329,400	534,800	56.7	266.7	319,700	527,000	61.7	270.8	305,100	515,600	95
100	49.8	258.8	309,300	503,100	53.6	263.0	300,200	495,800	58.8	267.7	286,400	485,000	100
105	46.4	253.9	291,200	473,600	50.3	258.7	282,600	467,900	55.8	264.2	269,600	457,600	105
110	42.7	248.4	274,700	446,000	46.9	254.0	266,600	442,700	52.6	260.3	254,300	433,000	110
115	38.6	242.1	259,700	421,400	43.2	248.6	252,000	419,900	49.3	255.9	240,300	410,700	115
120	34.2	234.8	245,900	400,100	39.2	242.4	238,600	399,100	45.8	251.0	227,500	390,300	120
125	29.1	225.9	233,200	367,700	34.9	235.2	226,300	380,100	42.0	245.3	215,800	371,800	125
130	23.0	214.6	221,200	324,200	29.9	226.6	214,800	362,700	38.0	238.9	204,900	354,700	130
135	14.1	197.5	209,800	267,400	23.9	215.7	204,100	341,400	33.4	231.3	194,800	339,000	135
140					15.7	199.9	193,800	286,400	28.2	222.2	185,300	324,400	140
145									21.8	210.3	176,300	310,800	145
150									11.9	191.2	167,400	279,700	150
155													155
160													160
165													165
170													170
175													175
180													180
185													185
190													190

# MLC650 VPC-MAX S-2

ASME B30.5

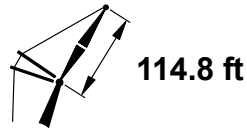
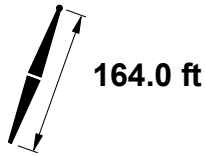
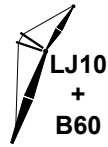

ft	75°				70°				65°				ft
	ft	°	ft	lb	ft	°	ft	lb	ft	°	ft	lb	
60													60
65													65
70													70
75													75
80													80
85													85
90													90
95													95
100													100
105	64.0	269.7	248,100	440,900									105
110	61.1	266.8	233,900	417,100									110
115	58.2	263.6	220,900	395,500									115
120	55.1	260.0	209,100	375,900									120
125	51.9	256.0	198,200	358,000									125
130	48.6	251.5	188,200	341,500	57.3	258.1	171,500	328,700					130
135	45.0	246.5	178,800	326,400	54.2	254.4	162,900	314,100					135
140	41.2	240.7	170,200	312,400	51.0	250.3	155,000	300,500					140
145	37.1	234.0	162,000	299,400	47.6	245.6	147,500	288,000					145
150	32.4	226.2	154,400	287,200	44.0	240.4	140,500	276,400	53.1	247.2	126,700	265,800	150
155	27.0	216.6	147,200	275,900	40.1	234.4	134,000	265,500	49.8	242.9	120,700	255,300	155
160	20.2	203.8	140,200	265,200	35.8	227.4	127,800	255,300	46.3	238.0	115,100	245,500	160
165	8.1	180.2	133,000	255,000	31.0	219.2	121,900	245,700	42.6	232.5	109,700	236,300	165
170					25.3	208.9	116,200	236,700	38.6	226.2	104,700	227,700	170
175					17.8	194.7	110,700	228,100	34.1	218.8	99,900	219,500	175
180									29.1	209.9	95,200	211,800	180
185									22.9	198.6	90,700	204,500	185
190									13.9	181.3	86,100	197,400	190

# MLC650 VPC-MAX S-2

ASME B30.5

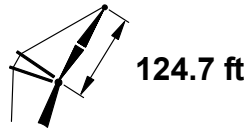
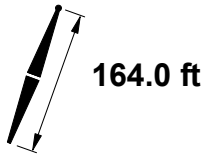
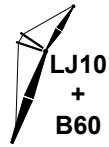

ft	85°				83°				80°				ft
	ft	lb	lb	lb	ft	lb	lb	lb	ft	lb	lb	lb	
60	74.6	292.9	604,700 b	638,600 b									60
65	72.1	291.2	550,400 b	627,900 b									65
70	69.7	289.3	504,400	616,800	72.5	290.8	490,600 b	633,100 b					70
75	67.2	287.1	465,000	605,400	70.0	288.9	452,100	624,000					75
80	64.6	284.6	430,800	593,900	67.5	286.7	418,800	614,300					80
85	62.0	281.9	400,800	578,800	65.0	284.3	389,600	600,900	69.3	286.8	373,000	587,900	85
90	59.3	278.8	374,300	553,600	62.4	281.6	363,800	561,300	66.8	284.6	348,200	549,100	90
95	56.5	275.5	350,700	522,500	59.7	278.6	340,900	526,400	64.2	282.1	326,200	514,900	95
100	53.7	271.7	329,600	492,500	56.9	275.2	320,300	495,300	61.6	279.3	306,400	484,400	100
105	50.7	267.5	310,600	463,900	54.1	271.5	301,800	467,500	58.9	276.2	288,600	457,200	105
110	47.5	262.9	293,300	437,200	51.1	267.4	285,000	442,400	56.1	272.7	272,500	432,600	110
115	44.2	257.7	277,600	412,700	48.0	262.8	269,700	419,700	53.2	268.9	257,800	410,400	115
120	40.7	251.8	263,200	390,300	44.7	257.7	255,600	399,000	50.2	264.7	244,300	390,100	120
125	36.8	245.1	249,900	370,300	41.2	251.9	242,700	380,100	47.0	259.9	232,000	371,600	125
130	32.6	237.3	237,600	353,100	37.4	245.4	230,800	362,700	43.7	254.6	220,500	354,600	130
135	27.7	227.9	226,100	329,900	33.2	237.7	219,700	346,700	40.1	248.6	210,000	339,000	135
140	21.7	215.9	215,400	297,200	28.4	228.6	209,400	331,900	36.2	241.8	200,100	324,500	140
145	13.0	197.7	205,000	244,100	22.7	217.1	199,600	307,600	31.8	233.7	190,900	311,100	145
150					14.6	200.3	190,200	260,900	26.8	224.0	182,200	298,600	150
155									20.6	211.5	173,900	286,800	155
160									10.9	191.0	165,700	253,300	160
165													165
170													170
175													175
180													180
185													185
190													190
195													195
200													200



# MLC650 VPC-MAX S-2

ASME B30.5

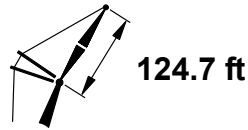
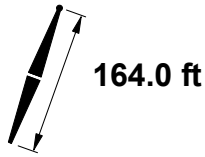

ft	75°				70°				65°				ft
	ft	ft	lb	lb	ft	ft	lb	lb	ft	ft	lb	lb	
60													60
65													65
70													70
75													75
80													80
85													85
90													90
95													95
100													100
105													105
110	63.7	278.1	251,800	416,600									110
115	61.0	275.3	238,100	395,100									115
120	58.3	272.1	225,600	375,600									120
125	55.5	268.6	214,100	357,700									125
130	52.6	264.7	203,500	341,300									130
135	49.5	260.3	193,600	326,200	57.5	266.6	177,500	313,800					135
140	46.3	255.5	184,500	312,300	54.7	263.0	169,000	300,300					140
145	42.9	250.0	176,000	299,400	51.7	258.9	161,100	287,900					145
150	39.3	243.9	168,000	287,300	48.7	254.5	153,700	276,300					150
155	35.3	236.8	160,500	276,100	45.4	249.5	146,800	265,500	53.6	255.8	133,300	255,200	155
160	30.9	228.5	153,400	265,600	41.9	243.8	140,300	255,400	50.6	251.6	127,300	245,400	160
165	25.7	218.4	146,700	255,700	38.2	237.4	134,200	245,900	47.5	246.9	121,700	236,300	165
170	19.0	204.8	140,200	246,400	34.1	230.1	128,400	237,000	44.2	241.7	116,400	227,700	170
175	6.9	178.9	133,400	237,300	29.5	221.3	122,800	228,600	40.6	235.8	111,300	219,600	175
180					24.0	210.5	117,500	220,600	36.8	229.1	106,500	212,000	180
185					16.7	195.4	112,200	213,000	32.5	221.3	101,900	204,800	185
190									27.6	211.9	97,500	197,900	190
195									21.6	199.9	93,200	191,400	195
200									12.9	181.5	88,800	185,000	200

# MLC650 VPC-MAX S-2

ASME B30.5

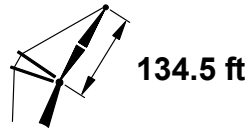
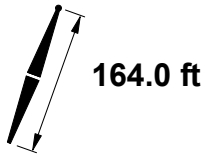

ft	85°				83°				80°				ft
	ft	lb	lb	lb	ft	lb	lb	lb	ft	lb	lb	lb	
65	73.5	301.6	548,000	585,900									65
70	71.2	299.9	502,000	579,500									70
75	68.9	297.9	462,600	569,600	71.6	299.4	449,600	584,800					75
80	66.6	295.6	428,400	559,500	69.3	297.4	416,300	576,700					80
85	64.2	293.1	398,500	549,400	66.9	295.2	387,100	568,100					85
90	61.8	290.4	372,100	533,200	64.6	292.8	361,400	558,600	68.6	295.4	345,400	546,200	90
95	59.3	287.3	348,500	505,900	62.2	290.1	338,500	523,800	66.2	293.1	323,400	512,100	95
100	56.8	284.0	327,500	478,900	59.7	287.1	317,900	492,800	63.9	290.6	303,700	481,700	100
105	54.1	280.3	308,500	452,700	57.1	283.8	299,500	465,100	61.4	287.8	286,000	454,600	105
110	51.4	276.2	291,200	427,700	54.5	280.1	282,700	440,100	58.9	284.7	269,900	430,100	110
115	48.5	271.7	275,600	404,100	51.8	276.1	267,400	417,400	56.3	281.3	255,300	407,900	115
120	45.5	266.7	261,200	382,200	48.9	271.7	253,500	396,800	53.7	277.5	241,900	387,800	120
125	42.3	261.2	248,000	361,900	45.9	266.7	240,600	378,000	50.9	273.4	229,600	369,300	125
130	38.9	254.9	235,800	343,700	42.8	261.3	228,800	360,700	48.0	268.8	218,200	352,400	130
135	35.2	247.8	224,500	327,500	39.4	255.2	217,800	344,800	45.0	263.7	207,700	336,800	135
140	31.1	239.6	214,000	313,400	35.8	248.2	207,600	330,000	41.8	258.1	197,900	322,400	140
145	26.4	229.7	204,100	295,900	31.7	240.1	198,000	316,400	38.3	251.7	188,800	309,100	145
150	20.6	217.1	194,800	266,900	27.1	230.5	189,100	303,600	34.6	244.5	180,300	296,700	150
155	12.1	197.7	185,700	219,500	21.5	218.4	180,600	276,800	30.4	236.0	172,300	285,000	155
160					13.7	200.6	172,300	234,900	25.6	225.8	164,700	274,200	160
165									19.5	212.5	157,400	263,900	165
170									9.9	190.6	150,100	228,100	170
175													175
180													180
185													185
190													190
195													195
200													200
205													205
210													210

# MLC650 VPC-MAX S-2

ASME B30.5

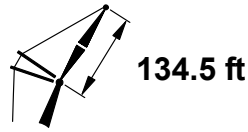
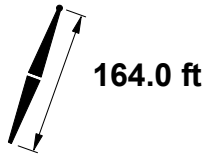

ft	75°				70°				65°				ft
	ft	°	ft	lb	ft	°	ft	lb	ft	°	ft	lb	
65													65
70													70
75													75
80													80
85													85
90													90
95													95
100													100
105													105
110													110
115	63.3	286.6	235,200	392,400									115
120	60.9	283.8	222,700	373,000									120
125	58.4	280.6	211,300	355,200									125
130	55.8	277.1	200,700	338,900									130
135	53.1	273.3	190,900	323,900									135
140	50.3	269.1	181,900	310,000	57.7	275.1	166,000	297,800					140
145	47.4	264.4	173,400	297,100	55.1	271.5	158,200	285,400					145
150	44.3	259.2	165,500	285,100	52.3	267.6	150,900	273,900					150
155	41.1	253.4	158,100	274,000	49.5	263.2	144,000	263,100					155
160	37.6	246.9	151,200	263,500	46.6	258.4	137,600	253,000	54.1	264.4	124,300	242,900	160
165	33.8	239.4	144,600	253,700	43.5	253.1	131,600	243,600	51.3	260.3	118,700	233,800	165
170	29.5	230.7	138,300	244,500	40.1	247.1	125,800	234,800	48.5	255.8	113,400	225,300	170
175	24.4	220.0	132,400	235,800	36.6	240.4	120,400	226,400	45.4	250.8	108,500	217,300	175
180	18.0	205.7	126,600	227,600	32.6	232.6	115,300	218,600	42.3	245.2	103,700	209,700	180
185	5.6	177.1	120,400	219,500	28.2	223.4	110,300	211,100	38.9	239.0	99,300	202,600	185
190					22.8	211.9	105,500	204,000	35.2	231.9	95,000	195,800	190
195					15.7	195.9	100,800	197,200	31.0	223.6	90,800	189,400	195
200									26.3	213.7	86,900	183,200	200
205									20.5	201.0	83,000	177,300	205
210									11.9	181.5	79,000	171,600	210

# MLC650 VPC-MAX S-2

ASME B30.5

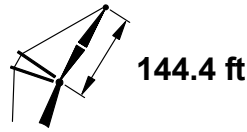
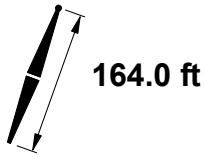

ft	85°				83°				80°				ft
	ft	lb	lb	lb	ft	lb	lb	lb	ft	lb	lb	lb	
65	74.7	312.0	535,200	535,200									65
70	72.6	310.3	500,300	535,200									70
75	70.5	308.5	460,900	534,600	72.9	309.8	447,700	533,200					75
80	68.3	306.4	426,700	525,900	70.8	308.0	414,400	533,200					80
85	66.1	304.1	396,800	517,000	68.6	306.0	385,300	532,700					85
90	63.9	301.6	370,400	508,100	66.4	303.8	359,600	525,000					90
95	61.6	298.8	346,900	488,400	64.2	301.3	336,700	517,100	68.0	303.9	321,500	509,900	95
100	59.3	295.8	325,900	464,700	62.0	298.5	316,200	490,800	65.8	301.6	301,900	479,600	100
105	56.9	292.5	306,900	441,200	59.7	295.5	297,800	463,100	63.6	299.0	284,200	452,500	105
110	54.5	288.8	289,700	418,300	57.3	292.3	281,100	438,200	61.3	296.2	268,100	428,200	110
115	52.0	284.9	274,100	396,200	54.8	288.7	265,800	415,600	58.9	293.1	253,500	406,100	115
120	49.3	280.5	259,800	375,400	52.3	284.7	251,900	395,100	56.6	289.8	240,200	386,000	120
125	46.6	275.7	246,600	355,700	49.7	280.4	239,100	376,300	54.1	286.1	227,900	367,600	125
130	43.7	270.4	234,500	337,500	47.0	275.7	227,300	359,100	51.5	282.0	216,600	350,700	130
135	40.6	264.5	223,300	320,800	44.1	270.5	216,400	343,200	48.9	277.6	206,100	335,200	135
140	37.3	257.9	212,800	305,600	41.1	264.7	206,300	328,500	46.1	272.7	196,400	320,800	140
145	33.8	250.5	203,100	292,200	37.8	258.2	196,800	314,900	43.2	267.4	187,400	307,500	145
150	29.8	241.8	194,000	280,600	34.3	250.9	188,000	302,300	40.1	261.4	178,900	295,200	150
155	25.2	231.5	185,400	267,400	30.4	242.4	179,700	290,500	36.8	254.7	171,000	283,600	155
160	19.6	218.2	177,200	241,400	25.9	232.3	171,800	275,100	33.2	247.0	163,500	272,800	160
165		197.6	169,100	198,600	20.5	219.6	164,300	250,800	29.1	238.1	156,500	262,700	165
170					12.8	200.8	157,000	212,900	24.4	227.4	149,700	253,200	170
175									18.6	213.5	143,300	244,200	175
180									9.0	190.0	136,700	206,600	180
185													185
190													190
195													195
200													200
205													205
210													210
215													215
220													220

# MLC650 VPC-MAX S-2

ASME B30.5

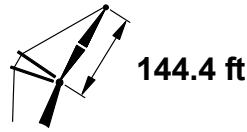
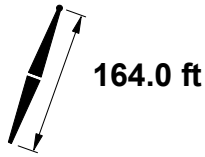
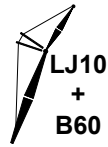

ft	75°				70°				65°				ft
	ft	°	ft	lb	ft	°	ft	lb	ft	°	ft	lb	
65													65
70													70
75													75
80													80
85													85
90													90
95													95
100													100
105													105
110													110
115													115
120	63.1	295.1	220,700	371,000									120
125	60.8	292.2	209,300	353,300									125
130	58.5	289.1	198,800	337,000									130
135	56.0	285.6	189,100	322,100									135
140	53.6	281.9	180,100	308,200									140
145	51.0	277.8	171,700	295,400	57.8	283.6	156,200	283,600					145
150	48.3	273.2	163,800	283,500	55.4	280.1	148,900	272,100					150
155	45.5	268.3	156,500	272,400	52.9	276.2	142,100	261,400					155
160	42.6	262.8	149,600	262,000	50.3	272.0	135,800	251,400					160
165	39.4	256.7	143,100	252,300	47.6	267.3	129,800	242,000	54.5	272.9	116,700	232,100	165
170	36.1	249.8	136,900	243,100	44.7	262.2	124,100	233,200	51.9	268.9	111,500	223,600	170
175	32.4	241.9	131,100	234,500	41.7	256.6	118,700	224,900	49.3	264.6	106,600	215,600	175
180	28.2	232.7	125,600	226,300	38.5	250.2	113,700	217,100	46.5	259.8	101,900	208,100	180
185	23.3	221.5	120,200	218,600	35.1	243.1	108,800	209,700	43.6	254.5	97,500	201,000	185
190	17.1	206.5	115,000	211,300	31.3	234.9	104,200	202,700	40.6	248.6	93,200	194,300	190
195	4.1	174.3	109,400	203,900	26.9	225.3	99,800	196,100	37.3	242.0	89,200	187,900	195
200					21.8	213.3	95,500	189,700	33.7	234.5	85,400	181,800	200
205					14.8	196.4	91,200	183,600	29.7	225.8	81,600	176,100	205
210									25.2	215.4	78,000	170,500	210
215									19.5	202.1	74,500	165,200	215
220									11.0	181.3	70,800	160,000	220

# MLC650 VPC-MAX S-2

ASME B30.5



661,300 lb

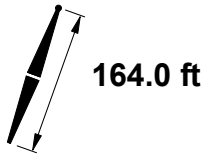

164.0 ft



154.2 ft

ft	85°				83°				80°				ft
	ft	ft	lb	lb	ft	ft	lb	lb	ft	ft	lb	lb	
70	73.7	320.7	491,700	491,700									70
75	71.8	319.0	485,300	491,700									75
80	69.8	317.1	449,400	490,700	72.0	318.5	436,900	489,600					80
85	67.8	315.0	418,000	488,300	70.1	316.6	406,200	489,600					85
90	65.7	312.6	390,200	480,800	68.0	314.6	379,200	489,600					90
95	63.6	310.1	365,500	468,800	66.0	312.3	355,100	488,400	69.5	314.6	339,600	478,200	95
100	61.5	307.3	343,400	448,400	63.9	309.8	333,500	481,400	67.4	312.5	318,900	476,900	100
105	59.3	304.3	323,500	427,600	61.8	307.0	314,100	460,700	65.4	310.1	300,200	450,000	105
110	57.1	301.0	305,400	407,100	59.6	304.0	296,500	435,800	63.3	307.5	283,300	425,700	110
115	54.8	297.4	289,000	387,000	57.4	300.8	280,500	413,300	61.2	304.7	267,900	403,600	115
120	52.5	293.5	274,000	367,500	55.1	297.2	265,900	392,900	59.0	301.6	253,900	383,600	120
125	50.0	289.2	260,200	349,000	52.8	293.3	252,500	374,100	56.7	298.3	241,000	365,300	125
130	47.5	284.6	247,500	331,500	50.4	289.1	240,100	357,000	54.5	294.6	229,100	348,500	130
135	44.8	279.5	235,700	315,100	47.9	284.6	228,700	341,100	52.1	290.7	218,100	333,000	135
140	42.1	273.9	224,800	299,900	45.2	279.5	218,000	326,500	49.6	286.4	207,900	318,700	140
145	39.1	267.7	214,600	286,000	42.5	274.0	208,100	313,000	47.1	281.7	198,400	305,400	145
150	35.9	260.8	205,100	273,400	39.5	267.9	198,900	300,400	44.4	276.5	189,600	293,100	150
155	32.5	253.0	196,200	262,200	36.4	261.1	190,200	288,600	41.6	270.8	181,300	281,600	155
160	28.6	243.9	187,800	252,600	33.0	253.4	182,100	277,600	38.6	264.5	173,500	270,900	160
165	24.2	233.1	179,900	242,000	29.2	244.6	174,400	267,300	35.4	257.5	166,100	260,800	165
170	18.7	219.2	172,300	218,300	24.9	234.0	167,100	249,100	31.9	249.5	159,200	251,300	170
175	10.4	197.4	164,700	179,500	19.6	220.7	160,100	227,500	28.0	240.2	152,600	242,400	175
180					12.0	200.9	153,300	192,700	23.4	229.0	146,300	234,000	180
185									17.7	214.4	140,200	226,000	185
190									8.2	189.3	134,000	186,800	190
195													195
200													200
205													205
210													210
215													215
220													220
230													230

# MLC650 VPC-MAX S-2

ASME B30.5

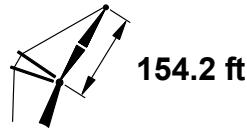
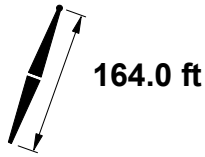

ft	75°				70°				65°				ft
	ft	°	ft	lb	ft	°	ft	lb	ft	°	ft	lb	
70													70
75													75
80													80
85													85
90													90
95													95
100													100
105													105
110													110
115													115
120	65.0	306.2	234,100	368,400									120
125	62.9	303.6	222,000	350,800									125
130	60.7	300.7	210,900	334,600									130
135	58.5	297.6	200,700	319,700									135
140	56.3	294.2	191,200	305,900									140
145	54.0	290.5	182,300	293,100									145
150	51.6	286.4	174,100	281,200	57.9	292.1	158,800	269,600					150
155	49.1	282.0	166,300	270,200	55.6	288.6	151,700	259,000					155
160	46.5	277.2	159,100	259,800	53.3	284.8	144,900	249,000					160
165	43.8	272.0	152,300	250,100	50.9	280.7	138,600	239,700					165
170	41.0	266.2	145,900	241,000	48.4	276.2	132,600	230,900	54.8	281.5	119,700	221,100	170
175	38.0	259.7	139,800	232,500	45.8	271.2	127,000	222,700	52.4	277.6	114,500	213,200	175
180	34.7	252.5	134,000	224,400	43.1	265.8	121,700	214,900	50.0	273.3	109,600	205,700	180
185	31.1	244.3	128,500	216,700	40.2	259.9	116,600	207,600	47.5	268.6	104,900	198,700	185
190	27.1	234.6	123,300	209,500	37.1	253.2	111,800	200,600	44.8	263.6	100,500	192,000	190
195	22.3	222.9	118,200	202,600	33.7	245.7	107,200	194,000	42.0	258.0	96,300	185,600	195
200	16.2	207.2	113,300	196,000	30.1	237.2	102,800	187,800	39.1	251.8	92,200	179,600	200
205					25.9	227.1	98,600	181,800	35.9	244.8	88,400	173,900	205
210					20.8	214.5	94,500	176,100	32.4	237.0	84,700	168,500	210
215					14.0	196.8	90,300	170,500	28.6	227.9	81,100	163,200	215
220									24.1	217.0	77,600	158,200	220
230									10.2	181.1	70,600	148,700	230

# MLC650 VPC-MAX S-2

ASME B30.5

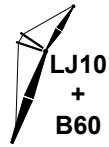

661,300 lb



360°

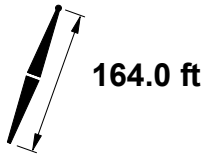

164.0 ft



164.0 ft

ft	85°				83°				80°				ft
	ft	lb	lb	lb	ft	lb	lb	lb	ft	lb	lb	lb	
70	74.7	331.0	449,600	449,600									70
75	72.9	329.4	449,600	449,600									75
80	71.1	327.6	448,800	449,400									80
85	69.2	325.7	417,400	448,300	71.3	327.2	405,600	448,100					85
90	67.3	323.5	389,700	446,300	69.4	325.2	378,500	448,100					90
95	65.3	321.1	365,000	443,100	67.5	323.1	354,500	448,100					95
100	63.4	318.6	342,900	430,900	65.6	320.8	333,000	448,100	68.9	323.2	318,100	437,700	100
105	61.4	315.8	323,000	413,000	63.7	318.2	313,600	447,200	67.0	321.0	299,500	437,700	105
110	59.3	312.8	305,000	394,900	61.7	315.5	296,000	434,800	65.0	318.6	282,600	424,600	110
115	57.3	309.5	288,600	376,900	59.6	312.5	280,000	412,400	63.1	316.0	267,300	402,600	115
120	55.1	305.9	273,600	359,100	57.6	309.2	265,400	392,000	61.1	313.2	253,300	382,600	120
125	52.9	302.1	259,800	341,900	55.4	305.7	252,000	373,300	59.0	310.1	240,400	364,400	125
130	50.6	297.9	247,100	325,300	53.2	301.9	239,700	356,200	56.9	306.8	228,500	347,600	130
135	48.3	293.4	235,400	309,600	51.0	297.8	228,200	340,400	54.8	303.2	217,600	332,200	135
140	45.8	288.5	224,500	294,700	48.6	293.4	217,700	325,800	52.6	299.3	207,400	317,900	140
145	43.3	283.1	214,400	280,900	46.2	288.5	207,800	312,300	50.3	295.1	197,900	304,700	145
150	40.6	277.3	205,000	268,000	43.7	283.2	198,600	299,700	47.9	290.5	189,100	292,400	150
155	37.7	270.8	196,100	256,200	41.0	277.4	190,000	288,000	45.4	285.5	180,800	281,000	155
160	34.7	263.5	187,800	245,500	38.1	271.0	181,900	277,100	42.9	280.1	173,100	270,300	160
165	31.3	255.4	180,000	236,000	35.1	263.9	174,300	266,800	40.1	274.1	165,800	260,200	165
170	27.6	245.9	172,600	227,900	31.8	255.9	167,100	257,200	37.3	267.5	158,900	250,800	170
175	23.3	234.6	165,500	221,500	28.1	246.6	160,300	246,200	34.1	260.2	152,500	241,900	175
180	17.9	220.1	158,700	199,800	23.9	235.6	153,800	228,000	30.7	251.8	146,300	233,600	180
185	9.7	197.0	152,000	164,100	18.8	221.7	147,600	208,700	26.9	242.1	140,400	225,700	185
190					11.2	200.8	141,400	176,500	22.5	230.4	134,800	218,200	190
195									16.9	215.1	129,300	208,100	195
200									7.3	188.3	123,700	170,800	200
205													205
210													210
215													215
220													220
230													230
240													240



# MLC650 VPC-MAX S-2

ASME B30.5

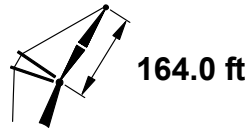
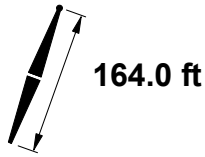

ft	75°				70°				65°				ft
	ft	°	ft	lb	ft	°	ft	lb	ft	°	ft	lb	
70													70
75													75
80													80
85													85
90													90
95													95
100													100
105													105
110													110
115													115
120													120
125	64.6	314.7	221,200	349,700									125
130	62.7	312.0	210,100	333,600									130
135	60.6	309.2	199,900	318,700									135
140	58.6	306.1	190,400	305,000									140
145	56.5	302.7	181,600	292,200									145
150	54.3	299.0	173,400	280,400									150
155	52.1	295.1	165,700	269,400	58.0	300.6	150,800	258,100					155
160	49.8	290.8	158,500	259,100	55.9	297.1	144,100	248,200					160
165	47.4	286.1	151,700	249,400	53.7	293.4	137,800	238,900					165
170	44.9	281.1	145,300	240,400	51.5	289.3	131,900	230,100					170
175	42.3	275.5	139,300	231,800	49.1	284.9	126,300	221,900					175
180	39.6	269.4	133,600	223,800	46.7	280.2	121,000	214,200	52.9	286.2	108,700	204,900	180
185	36.6	262.7	128,200	216,200	44.2	275.0	116,000	206,900	50.6	282.0	104,100	197,900	185
190	33.5	255.1	123,000	209,000	41.6	269.3	111,300	200,000	48.3	277.5	99,700	191,200	190
195	30.0	246.5	118,100	202,200	38.8	263.0	106,700	193,400	45.8	272.6	95,500	184,900	195
200	26.1	236.5	113,400	195,700	35.8	256.1	102,400	187,200	43.2	267.2	91,600	179,000	200
205	21.4	224.2	108,800	189,500	32.5	248.3	98,300	181,300	40.5	261.3	87,700	173,300	205
210	15.4	207.8	104,300	183,500	28.9	239.3	94,300	175,600	37.7	254.8	84,100	167,900	210
215					24.9	228.8	90,400	170,200	34.6	247.6	80,600	162,700	215
220					20.0	215.6	86,700	165,100	31.3	239.4	77,200	157,800	220
230									23.2	218.6	70,800	148,500	230
240									9.5	180.7	64,400	139,700	240

# MLC650 VPC-MAX S-2

ASME B30.5



661,300 lb

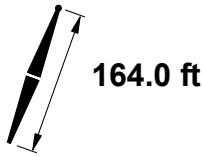

164.0 ft

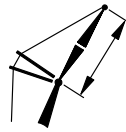

173.9 ft

ft	85°				83°				80°				ft
	ft	lb	lb	lb	ft	lb	lb	lb	ft	lb	lb	lb	
75	73.9	339.8	414,000	414,000									75
80	72.2	338.1	414,000	414,000									80
85	70.4	336.3	413,200	413,200	72.4	337.6	403,000	410,700					85
90	68.6	334.2	387,300	412,200	70.7	335.8	376,000	410,700					90
95	66.8	332.0	362,700	410,600	68.9	333.8	352,000	410,700					95
100	65.0	329.7	340,600	407,700	67.1	331.6	330,500	410,700					100
105	63.2	327.1	320,700	397,000	65.3	329.3	311,100	410,700	68.4	331.7	296,800	403,400	105
110	61.3	324.3	302,700	381,300	63.4	326.7	293,600	410,700	66.6	329.5	280,000	403,400	110
115	59.4	321.2	286,300	365,400	61.5	324.0	277,600	410,100	64.7	327.1	264,700	400,200	115
120	57.4	318.0	271,400	349,600	59.6	321.0	263,100	389,700	62.9	324.5	250,700	380,300	120
125	55.4	314.5	257,600	333,900	57.7	317.7	249,700	371,100	61.0	321.6	237,800	362,100	125
130	53.3	310.7	245,000	318,700	55.7	314.3	237,400	354,000	59.0	318.6	226,000	345,400	130
135	51.2	306.6	233,300	304,000	53.6	310.5	226,000	338,300	57.1	315.3	215,100	330,000	135
140	49.0	302.2	222,400	289,800	51.5	306.5	215,400	323,800	55.0	311.7	204,900	315,800	140
145	46.7	297.4	212,300	276,500	49.3	302.1	205,600	310,300	53.0	307.9	195,500	302,600	145
150	44.3	292.3	202,900	263,900	47.0	297.4	196,400	297,800	50.8	303.8	186,700	290,300	150
155	41.9	286.6	194,100	252,100	44.7	292.3	187,900	286,100	48.6	299.3	178,500	278,900	155
160	39.3	280.5	185,900	241,200	42.2	286.8	179,800	275,200	46.3	294.5	170,800	268,200	160
165	36.5	273.7	178,100	231,200	39.6	280.7	172,300	264,900	44.0	289.3	163,500	258,200	165
170	33.5	266.2	170,700	222,200	36.9	274.0	165,100	255,300	41.5	283.5	156,700	248,900	170
175	30.2	257.6	163,800	214,200	33.9	266.6	158,400	246,300	38.8	277.3	150,300	240,000	175
180	26.6	247.8	157,200	207,400	30.7	258.2	152,000	237,000	36.0	270.4	144,200	231,700	180
185	22.4	236.0	150,900	201,800	27.1	248.6	145,900	224,100	33.0	262.7	138,400	223,800	185
190	17.1	220.9	144,800	181,600	23.0	237.1	140,100	207,800	29.7	254.0	132,900	216,400	190
195	8.9	196.5	138,700	148,600	18.0	222.7	134,500	190,300	26.0	243.9	127,600	209,300	195
200					10.5	200.6	128,900	160,200	21.6	231.8	122,500	202,600	200
205									16.1	215.8	117,500	189,900	205
210									6.5	187.1	112,400	154,600	210
215													215
220													220
230													230
240													240
250													250

# MLC650 VPC-MAX S-2

ASME B30.5

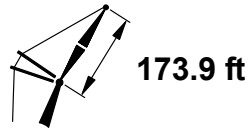
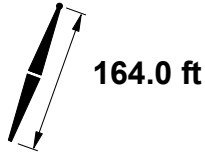

ft	75°				70°				65°				ft
	ft	°	ft	lb	ft	°	ft	lb	ft	°	ft	lb	
75													75
80													80
85													85
90													90
95													95
100													100
105													105
110													110
115													115
120													120
125													125
130	64.3	323.2	207,300	331,100									130
135	62.5	320.5	197,100	316,300									135
140	60.6	317.6	187,700	302,600									140
145	58.6	314.5	178,900	289,900									145
150	56.7	311.2	170,700	278,100									150
155	54.6	307.6	163,000	267,100									155
160	52.5	303.6	155,900	256,900	58.1	309.0	141,200	245,800					160
165	50.4	299.5	149,100	247,200	56.1	305.6	135,000	236,500					165
170	48.2	295.0	142,800	238,200	54.0	301.9	129,100	227,800					170
175	45.9	290.1	136,800	229,700	51.9	298.0	123,500	219,600					175
180	43.4	284.7	131,100	221,700	49.8	293.7	118,300	211,900					180
185	40.9	278.9	125,800	214,200	47.5	289.1	113,300	204,700	53.3	294.8	101,100	195,500	185
190	38.3	272.5	120,700	207,000	45.2	284.0	108,600	197,800	51.2	290.7	96,800	188,900	190
195	35.4	265.5	115,800	200,200	42.8	278.6	104,100	191,300	49.0	286.3	92,700	182,600	195
200	32.3	257.6	111,200	193,800	40.2	272.6	99,800	185,100	46.7	281.5	88,700	176,700	200
205	29.0	248.7	106,700	187,700	37.5	266.1	95,800	179,200	44.3	276.3	85,000	171,000	205
210	25.1	238.2	102,500	181,800	34.6	258.8	91,900	173,600	41.8	270.7	81,400	165,700	210
215	20.6	225.5	98,300	176,200	31.4	250.7	88,100	168,300	39.2	264.5	77,900	160,500	215
220	14.7	208.3	94,200	170,800	27.9	241.4	84,500	163,200	36.4	257.7	74,600	155,600	220
230					19.2	216.7	77,500	153,600	30.2	241.6	68,400	146,500	230
240									22.3	220.0	62,500	138,000	240
250									8.8	180.1	56,500	130,000	250

# MLC650 VPC-MAX S-2

ASME B30.5



661,300 lb



360°

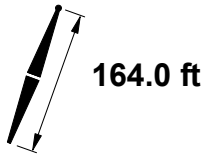

164.0 ft

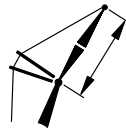

193.6 ft

ft	85°				83°				80°				ft
	ft	lb	lb	lb	ft	lb	lb	lb	ft	lb	lb	lb	
80	74.1	358.8	349,900	349,900									80
85	72.5	357.2	349,700	349,700									85
90	70.9	355.4	349,200	349,200	72.7	356.7	346,000	346,000					90
95	69.3	353.5	348,400	348,400	71.1	354.9	346,000	346,000					95
100	67.7	351.4	337,700	347,400	69.6	353.0	327,300	346,000					100
105	66.1	349.1	317,800	346,200	68.0	351.0	308,000	346,000					105
110	64.5	346.7	299,800	344,600	66.3	348.7	290,500	346,000	69.1	351.0	276,500	337,400	110
115	62.8	344.0	283,500	339,700	64.7	346.3	274,600	346,000	67.5	348.9	261,200	337,400	115
120	61.1	341.2	268,500	327,600	63.0	343.7	260,000	346,000	65.8	346.6	247,300	337,400	120
125	59.4	338.2	254,800	315,400	61.3	340.9	246,700	345,800	64.2	344.1	234,500	337,400	125
130	57.6	335.0	242,200	303,100	59.6	337.9	234,400	344,900	62.5	341.4	222,700	337,400	130
135	55.8	331.5	230,600	290,800	57.9	334.7	223,000	335,000	60.8	338.6	211,800	326,800	135
140	54.0	327.8	219,700	278,800	56.1	331.3	212,500	320,900	59.1	335.5	201,700	312,700	140
145	52.1	323.9	209,700	267,100	54.2	327.7	202,700	307,500	57.3	332.3	192,300	299,600	145
150	50.1	319.7	200,300	255,700	52.3	323.7	193,600	295,000	55.5	328.8	183,600	287,400	150
155	48.1	315.1	191,600	244,800	50.4	319.6	185,100	283,400	53.7	325.1	175,400	276,000	155
160	46.1	310.3	183,400	234,400	48.4	315.1	177,100	272,500	51.8	321.1	167,800	265,400	160
165	43.9	305.0	175,700	224,600	46.4	310.3	169,600	262,400	49.8	316.8	160,600	255,500	165
170	41.7	299.4	168,400	215,300	44.2	305.1	162,500	251,300	47.8	312.2	153,800	246,200	170
175	39.4	293.3	161,500	206,600	42.0	299.5	155,900	240,800	45.7	307.3	147,400	237,400	175
180	36.9	286.6	155,100	198,600	39.7	293.4	149,600	230,900	43.6	302.0	141,400	229,100	180
185	34.3	279.2	148,900	191,200	37.3	286.8	143,600	221,500	41.3	296.3	135,700	221,300	185
190	31.4	271.1	143,100	184,600	34.7	279.6	138,000	212,800	39.0	290.1	130,300	213,900	190
195	28.4	261.9	137,500	178,700	31.9	271.6	132,600	204,900	36.5	283.3	125,100	206,900	195
200	24.9	251.3	132,200	173,800	28.8	262.6	127,400	197,700	33.8	275.8	120,200	200,300	200
205	20.9	238.7	127,100	169,700	25.4	252.2	122,500	188,300	31.0	267.6	115,500	194,000	205
210	15.8	222.3	122,100	152,100	21.5	239.9	117,700	174,900	27.8	258.2	111,000	188,000	210
215	7.6	195.0	117,000	123,300	16.6	224.3	113,100	160,400	24.3	247.3	106,700	182,200	215
220					9.3	200.0	108,400	133,800	20.1	234.2	102,500	175,500	220
230									4.8	183.5	93,900	127,600	230
240													240
250													250
260													260
270													270

# MLC650 VPC-MAX S-2

ASME B30.5

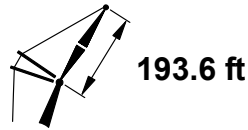
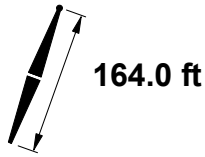

ft	75°				70°				65°				ft
	ft	ft	lb	lb	ft	ft	lb	lb	ft	ft	lb	lb	
80													80
85													85
90													90
95													95
100													100
105													105
110													110
115													115
120													120
125													125
130													130
135													135
140	63.8	340.2	184,000	299,200									140
145	62.2	337.5	175,200	286,600									145
150	60.5	334.6	167,100	274,900									150
155	58.7	331.5	159,500	264,000									155
160	56.9	328.2	152,400	253,800									160
165	55.1	324.7	145,700	244,200	60.0	329.2	131,100	233,200					165
170	53.3	320.9	139,400	235,200	58.2	326.0	125,300	224,600					170
175	51.4	316.8	133,500	226,800	56.4	322.7	119,800	216,500					175
180	49.4	312.5	127,900	218,800	54.6	319.1	114,600	208,800					180
185	47.4	307.8	122,600	211,300	52.8	315.2	109,700	201,600					185
190	45.3	302.9	117,600	204,300	50.8	311.1	105,000	194,800					190
195	43.1	297.5	112,800	197,500	48.9	306.7	100,600	188,300	53.9	311.9	88,800	179,400	195
200	40.9	291.7	108,200	191,200	46.8	301.9	96,400	182,200	52.1	308.0	84,900	173,500	200
205	38.5	285.3	103,900	185,100	44.7	296.8	92,400	176,400	50.1	303.7	81,200	167,900	205
210	36.0	278.4	99,700	179,300	42.5	291.3	88,600	170,800	48.1	299.2	77,700	162,600	210
215	33.3	270.8	95,800	173,800	40.2	285.4	84,900	165,600	46.1	294.3	74,300	157,600	215
220	30.3	262.3	92,000	168,600	37.8	278.9	81,400	160,500	43.9	289.1	71,100	152,700	220
230	23.5	241.4	84,700	158,700	32.5	264.0	74,800	151,100	39.3	277.3	65,000	143,700	230
240	13.4	209.0	77,800	149,600	26.2	245.2	68,700	142,400	34.2	263.3	59,400	135,400	240
250					17.8	218.6	62,800	134,400	28.3	245.9	54,200	127,700	250
260									20.8	222.6	49,200	120,600	260
270									7.4	178.5	44,000	113,700	270

# MLC650 VPC-MAX S-2

ASME B30.5



661,300 lb

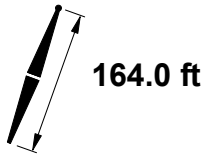

164.0 ft

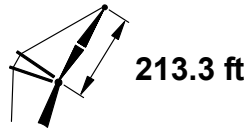

213.3 ft

ft	85°				83°				80°				ft
	ft	lb	lb	lb	ft	lb	lb	lb	ft	lb	lb	lb	
85	74.2	377.9	297,600	297,600									85
90	72.8	376.3	297,400	297,400									90
95	71.3	374.5	297,000	297,000	73.0	375.8	294,000	294,000					95
100	69.9	372.7	296,400	296,400	71.5	374.1	294,000	294,000					100
105	68.5	370.6	295,500	295,500	70.1	372.2	294,000	294,000					105
110	67.0	368.5	294,400	294,400	68.7	370.2	287,300	294,000					110
115	65.5	366.1	280,600	293,200	67.2	368.1	271,400	294,000	69.7	370.2	257,800	285,500	115
120	64.0	363.6	265,700	291,700	65.7	365.8	256,900	294,000	68.2	368.1	243,900	285,500	120
125	62.5	361.0	252,000	290,200	64.2	363.3	243,600	294,000	66.8	365.9	231,100	285,500	125
130	60.9	358.2	239,400	281,400	62.7	360.7	231,300	293,400	65.3	363.6	219,400	285,500	130
135	59.4	355.2	227,700	271,900	61.2	357.9	220,000	292,600	63.8	361.1	208,500	285,500	135
140	57.8	352.0	216,900	262,300	59.6	354.9	209,500	291,700	62.2	358.4	198,400	285,500	140
145	56.2	348.6	206,900	252,800	58.0	351.7	199,800	289,400	60.7	355.5	189,100	285,500	145
150	54.5	344.9	197,600	243,300	56.4	348.3	190,700	280,000	59.1	352.5	180,400	284,400	150
155	52.8	341.1	188,800	234,000	54.7	344.7	182,200	270,400	57.5	349.3	172,200	273,100	155
160	51.1	337.0	180,700	225,000	53.0	340.9	174,200	260,800	55.9	345.8	164,600	262,600	160
165	49.3	332.7	173,000	216,200	51.3	336.9	166,800	251,200	54.2	342.2	157,500	252,700	165
170	47.5	328.0	165,800	207,700	49.5	332.6	159,700	241,800	52.5	338.3	150,700	243,400	170
175	45.6	323.1	159,000	199,700	47.7	328.0	153,100	232,500	50.8	334.2	144,400	234,700	175
180	43.6	317.8	152,500	191,900	45.8	323.1	146,900	223,600	49.0	329.8	138,400	226,400	180
185	41.6	312.1	146,400	184,600	43.9	317.8	140,900	214,900	47.2	325.1	132,800	218,700	185
190	39.5	306.0	140,700	177,700	41.9	312.2	135,300	206,700	45.3	320.1	127,400	211,300	190
195	37.2	299.4	135,200	171,300	39.8	306.2	130,000	198,800	43.3	314.8	122,300	204,400	195
200	34.9	292.2	130,000	165,300	37.6	299.7	124,900	191,300	41.3	309.0	117,400	197,800	200
205	32.4	284.4	125,000	159,800	35.2	292.6	120,100	184,400	39.1	302.9	112,800	191,500	205
210	29.7	275.7	120,200	154,900	32.7	284.8	115,500	177,800	36.9	296.2	108,400	185,600	210
215	26.7	265.9	115,600	150,500	30.1	276.2	111,100	171,900	34.5	288.9	104,200	179,900	215
220	23.4	254.6	111,200	146,900	27.2	266.6	106,800	166,600	32.0	280.9	100,100	174,500	220
230	14.6	223.5	102,800	127,300	20.1	242.4	98,700	147,800	26.2	262.0	92,500	164,300	230
240					8.1	198.8	90,800	111,200	18.8	236.4	85,300	148,500	240
250									2.3	175.7	77,900	102,300	250
260													260
270													270
280													280
290													290

# MLC650 VPC-MAX S-2

ASME B30.5

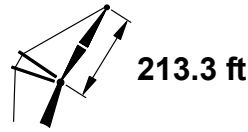
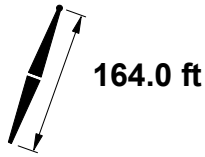

ft	75°				70°				65°				ft
	ft	°	ft	lb	ft	°	ft	lb	ft	°	ft	lb	
85													85
90													90
95													95
100													100
105													105
110													110
115													115
120													120
125													125
130													130
135													135
140													140
145	65.0	359.7	171,500	266,000									145
150	63.4	357.2	163,500	266,000									150
155	61.9	354.4	155,900	260,800									155
160	60.4	351.5	148,800	250,600									160
165	58.8	348.5	142,200	241,100									165
170	57.2	345.2	135,900	232,200									170
175	55.5	341.7	130,000	223,800	59.9	346.1	116,000	213,300					175
180	53.9	338.0	124,500	215,900	58.3	343.0	110,800	205,700					180
185	52.2	334.1	119,200	208,500	56.7	339.7	106,000	198,500					185
190	50.4	329.9	114,300	201,400	55.1	336.1	101,400	191,700					190
195	48.6	325.5	109,500	194,700	53.4	332.4	97,000	185,300					195
200	46.8	320.7	105,000	188,400	51.7	328.4	92,900	179,200					200
205	44.9	315.6	100,700	182,400	49.9	324.1	88,900	173,500	54.5	329.0	77,400	164,800	205
210	42.9	310.2	96,700	176,700	48.1	319.6	85,100	168,000	52.8	325.2	73,900	159,500	210
215	40.8	304.4	92,800	171,200	46.2	314.8	81,500	162,700	51.0	321.1	70,600	154,500	215
220	38.7	298.1	89,000	166,000	44.3	309.6	78,100	157,700	49.3	316.7	67,400	149,700	220
225	36.6	291.8	85,200	161,000	42.4	304.4	74,700	152,800	47.6	312.3	64,200	144,900	225
230	34.0	283.9	82,000	156,300	40.2	298.1	71,600	148,400	45.5	307.1	61,500	140,800	230
235	31.5	275.5	78,800	151,800	38.1	291.8	68,700	144,200	43.5	301.9	58,900	136,800	235
240	28.6	266.7	75,500	147,400	35.7	284.7	65,700	139,900	41.6	296.2	56,000	132,600	240
245	26.1	257.3	72,500	143,200	33.5	277.6	62,800	135,800	39.7	290.7	53,300	128,600	245
250	22.1	244.4	69,400	139,100	30.7	268.7	60,100	132,000	37.2	283.5	50,900	125,000	250
260	12.3	209.5	63,500	131,400	24.6	248.7	54,900	124,700	32.4	268.4	46,200	118,000	260
270					16.5	220.3	49,900	117,800	26.7	249.8	41,700	111,500	270
280									19.5	225.0	37,400	105,500	280
290									6.1	176.1	32,900	99,500	290

# MLC650 VPC-MAX S-2

ASME B30.5



661,300 lb

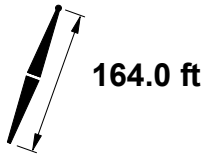

164.0 ft

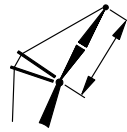

232.9 ft

ft	85°				83°				80°				ft
	ft	lb	lb	lb	ft	lb	lb	lb	ft	lb	lb	lb	
90	74.3	396.9	251,900	251,900									90
95	73.0	395.3	251,600	251,600									95
100	71.7	393.6	251,100	251,100									100
105	70.4	391.8	250,400	250,400	71.9	393.2	248,300	248,300					105
110	69.0	389.9	249,700	249,700	70.5	391.4	248,300	248,300					110
115	67.7	387.8	248,800	248,800	69.2	389.4	248,200	248,200					115
120	66.4	385.5	247,800	247,800	67.9	387.4	247,900	247,900					120
125	65.0	383.2	246,700	246,700	66.6	385.1	241,500	247,500	68.8	387.4	228,700	240,300	125
130	63.6	380.6	237,500	245,500	65.2	382.8	229,200	247,000	67.5	385.3	217,000	240,300	130
135	62.2	378.0	225,800	244,300	63.8	380.3	217,900	246,400	66.1	383.0	206,200	240,300	135
140	60.8	375.1	215,100	243,000	62.4	377.6	207,500	245,800	64.8	380.6	196,200	240,300	140
145	59.4	372.1	205,100	237,700	61.0	374.8	197,700	245,000	63.4	378.1	186,800	240,300	145
150	57.9	368.9	195,700	230,300	59.6	371.8	188,700	244,200	62.0	375.4	178,200	240,300	150
155	56.4	365.6	187,000	222,800	58.1	368.7	180,200	243,300	60.6	372.5	170,100	240,300	155
160	54.9	362.0	178,900	215,300	56.7	365.3	172,300	242,400	59.2	369.5	162,500	240,300	160
165	53.4	358.3	171,200	207,900	55.1	361.8	164,800	238,600	57.7	366.3	155,300	240,300	165
170	51.8	354.3	164,000	200,700	53.6	358.1	157,800	231,100	56.2	362.9	148,600	240,300	170
175	50.2	350.1	157,200	193,600	52.0	354.1	151,200	223,700	54.7	359.3	142,300	232,700	175
180	48.6	345.6	150,800	186,600	50.4	350.0	145,000	216,200	53.1	355.5	136,400	224,500	180
185	46.9	340.9	144,800	179,900	48.8	345.6	139,100	208,800	51.6	351.5	130,700	216,800	185
190	45.1	335.9	139,000	173,500	47.1	340.9	133,500	201,500	50.0	347.2	125,400	209,500	190
195	43.3	330.6	133,600	167,300	45.4	335.9	128,300	194,400	48.3	342.7	120,300	202,500	195
200	41.5	324.9	128,400	161,300	43.6	330.6	123,200	187,500	46.6	338.0	115,500	196,000	200
205	39.5	318.8	123,500	155,700	41.7	325.0	118,400	180,800	44.9	332.9	110,900	189,800	205
210	37.5	312.3	118,800	150,400	39.8	319.0	113,900	174,400	43.0	327.5	106,600	183,800	210
215	35.4	305.2	114,300	145,500	37.8	312.5	109,500	168,300	41.2	321.8	102,400	178,200	215
220	33.1	297.6	110,000	140,800	35.7	305.5	105,300	162,600	39.2	315.6	98,400	172,800	220
230	28.2	279.9	101,900	132,800	31.1	289.7	97,500	152,100	35.0	301.9	90,900	162,700	230
240	22.1	257.5	94,400	126,600	25.7	270.3	90,200	143,300	30.4	285.6	84,000	153,500	240
250	13.6	224.3	87,200	107,800	18.9	244.6	83,400	126,300	24.8	265.6	77,600	145,000	250
260					7.0	197.0	76,600	93,200	17.7	238.3	71,500	127,200	260
270													270
280													280
290													290
300													300
310													310



# MLC650 VPC-MAX S-2

ASME B30.5

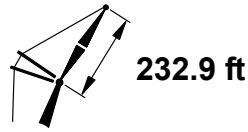
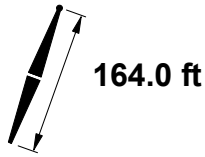

ft	75°				70°				65°				ft
	ft	°	lb	lb	ft	°	lb	lb	ft	°	lb	lb	
90													90
95													95
100													100
105													105
110													110
115													115
120													120
125													125
130													130
135													135
140													140
145													145
150													150
155	64.5	376.7	153,400	222,800									155
160	63.1	374.1	146,300	222,800									160
165	61.7	371.4	139,700	222,800									165
170	60.3	368.5	133,500	222,800									170
175	58.8	365.4	127,600	221,600									175
180	57.4	362.2	122,100	213,800									180
185	55.9	358.8	116,900	206,400	59.9	363.1	103,300	196,200					185
190	54.4	355.1	111,900	199,300	58.4	360.0	98,800	189,500					190
195	52.8	351.3	107,200	192,700	57.0	356.7	94,400	183,100					195
200	51.2	347.2	102,800	186,400	55.5	353.2	90,300	177,000					200
205	49.6	342.9	98,500	180,400	53.9	349.5	86,400	171,300					205
210	48.0	338.4	94,500	174,700	52.4	345.6	82,700	165,800					210
215	46.2	333.6	90,600	169,300	50.8	341.5	79,100	160,600	54.9	346.1	67,900	152,300	215
220	44.5	328.4	86,900	164,100	49.2	337.1	75,700	155,700	53.4	342.3	64,800	147,500	220
230	40.8	317.1	80,000	154,500	45.8	327.6	69,300	146,400	50.2	334.2	58,900	138,600	230
240	36.8	304.2	73,700	145,600	42.1	316.8	63,500	138,000	46.9	325.0	53,500	130,500	240
250	32.3	289.0	67,700	137,500	38.2	304.5	58,000	130,200	43.3	314.6	48,500	123,000	250
260	27.1	270.7	62,200	130,000	34.0	290.2	53,000	123,000	39.5	302.8	43,900	116,100	260
270	20.8	247.0	57,000	123,000	29.1	273.2	48,200	116,300	35.4	289.2	39,600	109,700	270
280	11.3	209.6	51,900	116,300	23.3	251.9	43,800	110,000	30.7	273.2	35,500	103,800	280
290					15.5	221.6	39,400	104,100	25.3	253.5	31,700	98,200	290
300									18.3	227.0	27,900	92,900	300
310									4.6	172.5	23,900	87,700	310

# MLC650 VPC-MAX S-2

ASME B30.5



661,300 lb

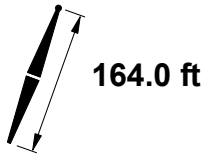

164.0 ft

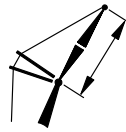

252.6 ft

ft	85°				83°				80°				ft
	ft	lb	lb	lb	ft	lb	lb	lb	ft	lb	lb	lb	
95	74.3	416.0	215,000	215,000									95
100	73.2	414.4	214,700	214,700									100
105	72.0	412.7	214,100	214,100									105
110	70.8	411.0	213,400	213,400	72.1	412.3	211,600	211,600					110
115	69.5	409.0	212,600	212,600	70.9	410.5	211,400	211,400					115
120	68.3	407.0	211,800	211,800	69.7	408.6	211,100	211,100					120
125	67.1	404.9	210,900	210,900	68.5	406.6	210,700	210,700					125
130	65.8	402.6	209,900	209,900	67.3	404.5	210,300	210,300	69.3	406.6	204,100	204,100	130
135	64.6	400.2	208,900	208,900	66.0	402.2	209,700	209,700	68.1	404.5	202,500	204,100	135
140	63.3	397.6	207,800	207,800	64.8	399.8	204,000	209,100	66.9	402.4	192,500	204,100	140
145	62.0	394.9	201,800	206,600	63.5	397.3	194,300	208,500	65.6	400.1	183,200	204,100	145
150	60.7	392.1	192,500	205,500	62.2	394.6	185,300	207,800	64.4	397.6	174,500	204,100	150
155	59.4	389.1	183,800	204,300	60.9	391.8	176,800	207,000	63.1	395.0	166,400	204,100	155
160	58.0	385.9	175,700	200,300	59.6	388.8	168,900	206,200	61.8	392.3	158,900	204,100	160
165	56.7	382.6	168,000	194,400	58.2	385.7	161,500	205,300	60.5	389.4	151,800	204,100	165
170	55.3	379.1	160,800	188,600	56.9	382.3	154,500	204,500	59.2	386.4	145,100	204,100	170
175	53.9	375.4	154,100	182,700	55.5	378.9	148,000	203,600	57.8	383.2	138,800	204,000	175
180	52.5	371.5	147,700	176,800	54.1	375.2	141,700	202,400	56.5	379.9	132,900	203,700	180
185	51.0	367.4	141,700	171,100	52.7	371.4	135,900	196,600	55.1	376.4	127,300	203,300	185
190	49.5	363.1	135,900	165,500	51.2	367.3	130,300	190,700	53.7	372.6	122,000	202,900	190
195	48.0	358.6	130,500	160,000	49.7	363.0	125,100	184,800	52.2	368.7	116,900	199,700	195
200	46.4	353.8	125,400	154,700	48.2	358.5	120,100	179,000	50.8	364.6	112,100	193,100	200
205	44.8	348.7	120,500	149,600	46.6	353.7	115,300	173,200	49.3	360.2	107,600	186,900	205
210	43.1	343.3	115,800	144,600	45.0	348.7	110,800	167,600	47.7	355.7	103,200	181,000	210
215	41.4	337.6	111,300	139,800	43.3	343.4	106,400	162,100	46.1	350.8	99,100	175,400	215
220	39.6	331.5	107,100	135,300	41.6	337.7	102,300	156,800	44.5	345.7	95,200	170,100	220
230	35.8	318.1	99,100	127,000	38.0	325.3	94,600	146,700	41.1	334.5	87,800	160,100	230
240	31.6	302.6	91,700	119,500	34.1	311.0	87,400	137,600	37.4	321.8	80,900	150,900	240
250	26.8	283.9	84,900	113,400	29.6	294.3	80,800	129,500	33.4	307.3	74,600	142,500	250
260	21.0	260.2	78,500	108,800	24.5	273.8	74,600	122,700	28.9	290.1	68,800	133,700	260
270	12.7	224.9	72,400	89,600	17.9	246.6	68,800	106,600	23.6	268.9	63,300	123,900	270
280					5.9	194.5	62,900	76,100	16.7	240.0	58,000	107,600	280
290													290
300													300
310													310
320													320
330													330

# MLC650 VPC-MAX S-2

ASME B30.5

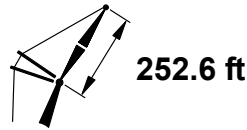
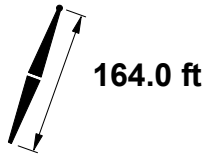

ft	75°				70°				65°				ft
	ft	°	ft	lb	ft	°	ft	lb	ft	°	ft	lb	
95													95
100													100
105													105
110													110
115													115
120													120
125													125
130													130
135													135
140													140
145													145
150													150
155													155
160													160
165	64.1	393.7	135,800	189,400									165
170	62.8	391.1	129,600	189,400									170
175	61.5	388.4	123,800	189,400									175
180	60.2	385.5	118,300	189,400									180
185	58.9	382.4	113,100	189,400									185
190	57.5	379.2	108,200	189,400									190
195	56.2	375.8	103,500	189,400	59.9	380.0	90,400	173,500					195
200	54.8	372.2	99,100	183,300	58.5	376.9	86,300	173,500					200
205	53.4	368.5	94,900	177,400	57.2	373.7	82,500	168,100					205
210	51.9	364.5	90,900	171,700	55.8	370.2	78,800	162,700					210
215	50.4	360.3	87,000	166,400	54.4	366.6	75,200	157,500					215
220	48.9	355.9	83,400	161,200	53.0	362.8	71,900	152,600					220
230	45.8	346.4	76,500	151,600	50.0	354.5	65,600	143,400	53.9	359.5	54,900	135,400	230
240	42.5	335.7	70,300	142,800	47.0	345.4	59,800	135,000	51.0	351.5	49,500	127,300	240
250	38.9	323.7	64,400	134,800	43.7	335.1	54,400	127,200	47.9	342.6	44,600	119,900	250
260	35.1	309.9	59,100	127,300	40.2	323.6	49,500	120,100	44.8	332.7	40,100	113,100	260
270	30.8	293.9	54,000	120,400	36.5	310.5	44,800	113,500	41.4	321.7	35,900	106,800	270
280	25.8	274.5	49,300	114,000	32.4	295.4	40,500	107,300	37.7	309.1	31,900	100,900	280
290	19.7	249.4	44,800	108,000	27.7	277.4	36,400	101,600	33.7	294.7	28,200	95,400	290
300	10.4	209.4	40,200	101,200	22.1	254.8	32,500	96,200	29.3	277.7	24,700	90,300	300
310					14.5	222.7	28,700	91,100	24.0	256.9	21,400	85,400	310
320									17.3	228.9		80,800	320
330									2.8	166.1		76,200	330

# MLC650 VPC-MAX S-2

ASME B30.5

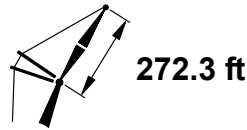
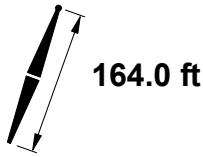

ft	85°				83°				80°				ft
	ft	lb	lb	lb	ft	lb	lb	lb	ft	lb	lb	lb	
100	74.4	435.0	183,100	183,100									100
105	73.3	433.5	182,700	182,700									105
110	72.2	431.8	182,100	182,100									110
115	71.1	430.1	181,500	181,500	72.4	431.4	180,200	180,200					115
120	70.0	428.2	180,700	180,700	71.2	429.6	179,900	179,900					120
125	68.8	426.2	180,000	180,000	70.1	427.8	179,500	179,500					125
130	67.7	424.2	179,100	179,100	69.0	425.8	179,100	179,100					130
135	66.5	422.0	178,300	178,300	67.9	423.7	178,600	178,600	69.8	425.8	174,000	174,000	135
140	65.4	419.6	177,400	177,400	66.7	421.6	178,100	178,100	68.7	423.8	174,000	174,000	140
145	64.2	417.2	176,400	176,400	65.6	419.2	177,500	177,500	67.5	421.7	174,000	174,000	145
150	63.0	414.6	175,500	175,500	64.4	416.8	176,800	176,800	66.4	419.4	172,100	174,000	150
155	61.8	411.9	174,500	174,500	63.2	414.2	174,700	176,200	65.2	417.1	164,100	174,000	155
160	60.6	409.0	173,500	173,500	62.0	411.6	166,800	175,500	64.0	414.6	156,500	173,800	160
165	59.4	406.0	166,100	172,500	60.8	408.7	159,400	174,700	62.8	412.0	149,500	173,600	165
170	58.2	402.9	158,900	171,400	59.6	405.7	152,400	174,000	61.6	409.3	142,800	173,300	170
175	56.9	399.6	152,100	170,400	58.3	402.6	145,900	173,200	60.4	406.4	136,600	172,900	175
180	55.6	396.1	145,800	165,700	57.1	399.3	139,700	172,400	59.2	403.4	130,700	172,600	180
185	54.3	392.5	139,800	161,100	55.8	395.9	133,900	171,600	58.0	400.2	125,100	172,200	185
190	53.0	388.7	134,100	156,500	54.5	392.3	128,300	170,800	56.7	396.9	119,800	171,800	190
195	51.6	384.7	128,700	152,000	53.2	388.5	123,100	170,000	55.4	393.4	114,800	171,300	195
200	50.3	380.5	123,600	147,400	51.8	384.6	118,100	168,600	54.1	389.7	110,000	170,900	200
205	48.9	376.1	118,700	143,000	50.5	380.4	113,400	164,000	52.8	385.9	105,500	170,400	205
210	47.4	371.5	114,000	138,700	49.1	376.0	108,900	159,400	51.4	381.9	101,200	170,100	210
215	46.0	366.6	109,600	134,400	47.6	371.4	104,600	154,800	50.1	377.7	97,100	169,500	215
220	44.5	361.5	105,400	130,300	46.2	366.6	100,500	150,300	48.6	373.2	93,100	168,300	220
230	41.3	350.4	97,500	122,500	43.1	356.1	92,800	141,500	45.7	363.7	85,800	158,300	230
240	38.0	337.9	90,200	115,300	39.9	344.5	85,700	133,100	42.7	353.0	79,100	149,200	240
250	34.3	323.7	83,500	108,800	36.4	331.3	79,200	125,300	39.4	341.1	72,800	140,900	250
260	30.3	307.3	77,200	103,100	32.6	316.2	73,200	118,200	35.9	327.7	67,100	133,200	260
270	25.6	287.6	71,400	98,200	28.4	298.6	67,500	111,900	32.0	312.3	61,700	124,400	270
280	20.0	262.7	65,900	94,700	23.4	277.1	62,200	105,100	27.7	294.2	56,700	115,500	280
290	11.8	225.2	60,500	74,900	17.0	248.4	57,200	90,800	22.5	271.9	51,900	106,400	290
300					4.7	191.0	51,900	62,100	15.8	241.5	47,300	91,900	300
310													310
320													320
330													330
340													340

# MLC650 VPC-MAX S-2

ASME B30.5

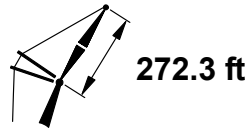
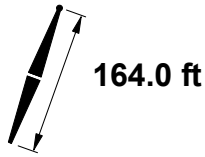

ft	75°				70°				65°				ft
	ft	ft	lb	lb	ft	ft	lb	lb	ft	ft	lb	lb	
100													100
105													105
110													110
115													115
120													120
125													125
130													130
135													135
140													140
145													145
150													150
155													155
160													160
165													165
170	65.0	413.2	127,000	161,400									170
175	63.8	410.7	121,200	161,400									175
180	62.6	408.1	115,800	161,400									180
185	61.4	405.3	110,600	161,400									185
190	60.2	402.4	105,700	161,400									190
195	58.9	399.4	101,100	161,400									195
200	57.7	396.2	96,700	161,400									200
205	56.4	392.8	92,500	161,400	59.8	397.0	79,800	148,900					205
210	55.1	389.3	88,500	161,400	58.6	393.9	76,100	148,900					210
215	53.8	385.6	84,700	161,400	57.3	390.7	72,600	148,900					215
220	52.5	381.7	81,100	159,200	56.1	387.3	69,300	148,900					220
230	49.8	373.4	74,300	149,700	53.5	379.9	63,100	141,300					230
240	46.9	364.2	68,100	141,000	50.8	371.9	57,300	133,000	54.3	376.6	46,900	125,200	240
250	43.9	354.0	62,300	133,000	47.9	363.0	52,100	125,300	51.6	368.8	42,100	117,800	250
260	40.7	342.6	57,000	125,600	45.0	353.2	47,200	118,200	48.9	360.2	37,600	111,000	260
270	37.3	329.9	52,100	118,800	41.9	342.3	42,600	111,700	45.9	350.7	33,400	104,800	270
280	33.6	315.3	47,500	112,400	38.6	330.1	38,400	105,600	42.9	340.1	29,600	99,000	280
290	29.5	298.4	43,100	106,500	35.0	316.2	34,400	99,900	39.6	328.3	25,900	93,500	290
300	24.7	278.0	39,000	100,900	31.0	300.3	30,700	94,600	36.1	315.0	22,500	88,500	300
310	18.7	251.6	35,100	95,700	26.5	281.3	27,100	89,600	32.3	299.8		83,700	310
320	9.5	209.0	31,100	86,300	21.1	257.6	23,700	84,900	28.0	281.9		79,200	320
330					13.6	223.6	20,400	80,400	22.9	260.0		75,000	330
340									16.4	230.5		71,000	340

# MLC650 VPC-MAX S-2

ASME B30.5

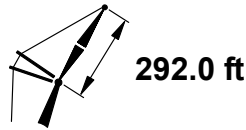
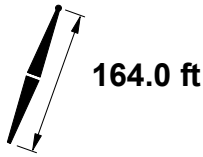

ft	85°				83°				80°				ft
	ft	lb	lb	lb	ft	lb	lb	lb	ft	lb	lb	lb	
105	74.5	454.1	156,000	156,000									105
110	73.4	452.5	155,400	155,400									110
115	72.4	450.9	154,700	154,700									115
120	71.4	449.2	154,000	154,000	72.6	450.4	153,000	153,000					120
125	70.3	447.4	153,300	153,300	71.5	448.7	152,600	152,600					125
130	69.3	445.4	152,500	152,500	70.5	446.9	152,100	152,100					130
135	68.2	443.4	151,600	151,600	69.4	445.0	151,500	151,500					135
140	67.2	441.3	150,800	150,800	68.4	443.0	150,900	150,900					140
145	66.1	439.0	149,900	149,900	67.3	440.9	150,300	150,300	69.1	443.0	147,000	147,000	145
150	65.0	436.7	148,900	148,900	66.2	438.6	149,600	149,600	68.1	440.9	146,800	146,800	150
155	63.9	434.2	148,000	148,000	65.1	436.3	148,900	148,900	67.0	438.8	146,500	146,500	155
160	62.8	431.6	147,100	147,100	64.1	433.8	148,200	148,200	65.9	436.5	146,200	146,200	160
165	61.7	428.8	146,100	146,100	62.9	431.2	147,500	147,500	64.8	434.1	145,600	145,900	165
170	60.5	426.0	145,200	145,200	61.8	428.5	146,700	146,700	63.7	431.6	138,900	145,500	170
175	59.4	423.0	144,200	144,200	60.7	425.7	142,200	146,000	62.6	429.0	132,700	145,100	175
180	58.2	419.9	142,200	143,300	59.6	422.7	136,000	145,200	61.5	426.2	126,800	144,700	180
185	57.1	416.6	136,200	142,300	58.4	419.6	130,200	144,400	60.4	423.4	121,200	144,200	185
190	55.9	413.2	130,500	141,300	57.2	416.3	124,700	143,600	59.2	420.3	116,000	143,800	190
195	54.7	409.6	125,100	140,400	56.1	412.9	119,500	142,800	58.1	417.2	111,000	143,200	195
200	53.5	405.8	120,000	137,600	54.8	409.4	114,500	142,000	56.9	413.9	106,200	142,700	200
205	52.2	401.9	115,200	134,000	53.6	405.7	109,800	141,200	55.7	410.4	101,700	142,200	205
210	50.9	397.8	110,500	130,400	52.4	401.8	105,300	140,400	54.5	406.8	97,400	141,600	210
215	49.6	393.5	106,100	126,900	51.1	397.7	101,000	139,600	53.3	403.1	93,300	141,100	215
220	48.3	389.1	101,900	123,300	49.8	393.4	96,900	138,900	52.0	399.1	89,400	140,600	220
230	45.6	379.4	94,000	116,500	47.2	384.3	89,200	133,600	49.4	390.7	82,100	139,500	230
240	42.7	368.8	86,800	110,100	44.4	374.3	82,200	126,600	46.8	381.4	75,400	138,400	240
250	39.7	357.1	80,100	104,000	41.5	363.2	75,800	119,800	44.0	371.3	69,200	137,500	250
260	36.5	343.9	74,000	98,300	38.3	350.9	69,800	113,300	41.0	360.0	63,500	130,300	260
270	32.9	329.0	68,200	93,200	35.0	337.0	64,200	107,200	37.9	347.5	58,200	122,200	270
280	29.0	311.7	62,800	88,700	31.3	321.2	59,000	101,600	34.5	333.3	53,300	113,500	280
290	24.5	291.1	57,800	84,900	27.2	302.7	54,100	96,700	30.7	317.2	48,600	105,300	290
300	19.0	265.0	53,000	78,800	22.3	280.1	49,500	87,900	26.5	298.1	44,300	97,700	300
310	11.0	225.3	48,300	60,300	16.1	250.0	45,100	75,200	21.5	274.8	40,100	89,200	310
320					3.3	185.7	40,400	47,500	14.9	242.8	36,100	76,300	320
330													330
340													340
350													350
360													360

# MLC650 VPC-MAX S-2

ASME B30.5

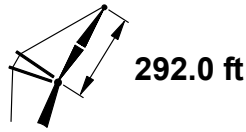
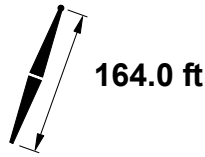
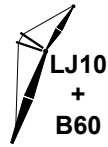

ft	75°				70°				65°				
	ft	°	ft	lb	ft	°	ft	lb	ft	°	ft	lb	
105													105
110													110
115													115
120													120
125													125
130													130
135													135
140													140
145													145
150													150
155													155
160													160
165													165
170													170
175													175
180	64.6	430.2	111,600	135,700									180
185	63.5	427.7	106,500	135,700									185
190	62.4	425.0	101,600	135,700									190
195	61.3	422.3	97,000	135,700									195
200	60.1	419.4	92,600	135,700									200
205	59.0	416.3	88,500	135,700									205
210	57.8	413.1	84,500	135,700									210
215	56.6	409.8	80,700	135,700	59.8	413.9	68,400	124,400					215
220	55.4	406.3	77,100	135,700	58.7	410.9	65,100	124,400					220
230	53.0	398.9	70,400	135,700	56.3	404.3	58,900	124,400					230
240	50.5	390.7	64,200	135,700	53.9	397.1	53,200	124,400					240
250	47.8	381.8	58,500	129,900	51.4	389.2	48,000	122,100	54.7	393.7	114,400		250
260	45.1	372.0	53,200	122,600	48.8	380.6	43,200	115,000	52.2	386.0	107,700		260
270	42.2	361.2	48,300	115,800	46.1	371.1	38,700	108,500	49.6	377.6	101,500		270
280	39.1	349.2	43,800	109,400	43.3	360.7	34,500	102,500	47.0	368.4	95,700		280
290	35.8	335.8	39,500	103,600	40.3	349.1	30,600	96,900	44.2	358.3	90,400		290
300	32.3	320.5	35,500	98,100	37.1	336.2	26,900	91,600	41.2	347.1	85,300		300
310	28.3	302.7	31,700	92,900	33.6	321.6	23,500	86,700	38.1	334.7	80,600		310
320	23.6	281.3	28,100	88,100	29.8	304.9	20,200	82,100	34.7	320.7	76,200		320
330	17.8	253.6	24,600	83,500	25.4	285.0		77,700	31.0	304.7	72,100		330
340	8.7	208.2	21,100	71,400	20.1	260.1		73,500	26.8	285.9	68,100		340
350					12.8	224.3		69,600	21.9	263.0	64,400		350
360									15.5	231.9	60,800		360

# MLC650 VPC-MAX S-2

ASME B30.5



661,300 lb

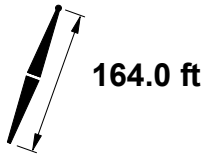

164.0 ft



311.7 ft

ft	85°				83°				80°				ft
	ft	lb	lb	lb	ft	lb	lb	lb	ft	lb	lb	lb	
110	74.5	473.1	134,400	134,400									110
115	73.6	471.6	133,400	133,400									115
120	72.6	470.0	132,800	132,800									120
125	71.6	468.3	132,100	132,100	72.7	469.5	131,200	131,200					125
130	70.7	466.5	131,400	131,400	71.8	467.8	130,800	130,800					130
135	69.7	464.6	130,600	130,600	70.8	466.1	130,200	130,200					135
140	68.7	462.6	129,800	129,800	69.8	464.2	129,700	129,700					140
145	67.7	460.6	129,000	129,000	68.8	462.2	129,100	129,100					145
150	66.7	458.4	128,200	128,200	67.8	460.1	128,500	128,500	69.5	462.2	125,700	125,700	150
155	65.7	456.1	127,400	127,400	66.8	458.0	127,800	127,800	68.5	460.2	125,400	125,400	155
160	64.7	453.7	126,500	126,500	65.8	455.7	127,200	127,200	67.5	458.1	125,100	125,100	160
165	63.6	451.2	125,700	125,700	64.8	453.3	126,500	126,500	66.5	455.9	124,700	124,700	165
170	62.6	448.5	124,800	124,800	63.8	450.8	125,800	125,800	65.5	453.6	124,400	124,400	170
175	61.5	445.8	123,900	123,900	62.7	448.2	125,100	125,100	64.5	451.1	124,000	124,000	175
180	60.5	442.9	123,100	123,100	61.7	445.5	124,400	124,400	63.5	448.6	123,500	123,500	180
185	59.4	439.9	122,200	122,200	60.6	442.6	123,600	123,600	62.4	446.0	119,000	123,100	185
190	58.3	436.8	121,400	121,400	59.6	439.7	122,600	122,900	61.4	443.2	113,700	122,600	190
195	57.2	433.6	120,500	120,500	58.5	436.6	117,400	122,200	60.3	440.3	108,800	122,100	195
200	56.1	430.2	118,100	119,600	57.4	433.3	112,500	121,500	59.2	437.3	104,000	121,600	200
205	55.0	426.6	113,300	118,800	56.3	429.9	107,800	120,700	58.1	434.2	99,500	121,100	205
210	53.8	423.0	108,600	118,000	55.1	426.4	103,300	120,000	57.1	430.9	95,300	120,600	210
215	52.7	419.1	104,200	117,200	54.0	422.8	99,000	119,300	55.9	427.5	91,200	120,100	215
220	51.5	415.1	100,000	115,000	52.9	418.9	94,900	118,600	54.8	423.9	87,300	119,500	220
230	49.1	406.6	92,200	109,300	50.5	410.8	87,300	117,200	52.5	416.3	80,000	118,500	230
240	46.6	397.2	85,000	103,700	48.0	401.9	80,300	115,900	50.1	408.1	73,400	117,500	240
250	44.0	387.0	78,300	98,300	45.5	392.3	73,900	112,600	47.6	399.1	67,200	116,500	250
260	41.2	375.8	72,200	93,200	42.8	381.6	67,900	107,000	45.1	389.3	61,500	115,500	260
270	38.3	363.5	66,500	88,400	40.0	370.0	62,400	101,600	42.4	378.5	56,300	114,700	270
280	35.1	349.6	61,200	83,900	36.9	357.0	57,300	96,500	39.5	366.7	51,400	112,700	280
290	31.7	334.0	56,300	79,900	33.7	342.4	52,500	91,700	36.5	353.5	46,800	104,700	290
300	27.9	316.0	51,600	76,400	30.1	325.9	47,900	87,300	33.2	338.7	42,500	97,200	300
310	23.6	294.4	47,200	73,400	26.1	306.5	43,700	83,400	29.6	321.7	38,500	90,300	310
320	18.2	267.1	43,000	66,200	21.4	282.9	39,600	74,400	25.5	301.9	34,600	83,700	320
330	10.3	225.2	38,800	49,100	15.3	251.3	35,700	63,100	20.6	277.4	30,900	75,700	330
340									14.2	243.8	27,400	64,100	340
350													350
360													360
370													370
380													380



# MLC650 VPC-MAX S-2

ASME B30.5

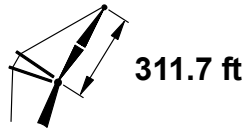
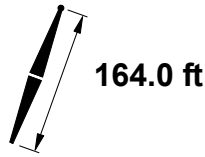

ft	75°				70°				65°					
	ft	°	ft	lb	ft	°	ft	lb	ft	°	ft	lb	ft	
110														110
115														115
120														120
125														125
130														130
135														135
140														140
145														145
150														150
155														155
160														160
165														165
170														170
175														175
180														180
185														185
190	64.3	447.2	99,100	115,500										190
195	63.2	444.7	94,500	115,500										195
200	62.2	442.0	90,200	115,500										200
205	61.1	439.2	86,000	115,500										205
210	60.1	436.3	82,100	115,500										210
215	59.0	433.3	78,300	115,500										215
220	57.9	430.1	74,800	115,500										220
230	55.7	423.4	68,100	115,400	58.7	427.8	56,400	105,500						230
240	53.4	416.0	61,900	115,100	56.5	421.3	50,700	105,500						240
250	51.1	408.1	56,300	114,800	54.3	414.2	45,500	105,500						250
260	48.6	399.4	51,000	114,400	51.9	406.4	40,700	105,500	55.0	410.7	96,400			260
270	46.1	389.9	46,200	114,000	49.5	398.0	36,300	105,500	52.7	403.2	96,400			270
280	43.5	379.5	41,700	107,700	47.0	388.8	32,200	100,600	50.3	395.0	93,700			280
290	40.7	368.1	37,500	101,800	44.4	378.8	28,300	95,000	47.8	386.1	88,400			290
300	37.7	355.5	33,500	96,400	41.7	367.8	24,700	89,800	45.3	376.3	83,400			300
310	34.5	341.4	29,800	91,300	38.8	355.6	21,300	84,900	42.6	365.6	78,700			310
320	31.1	325.3	26,300	86,500	35.7	342.1		80,300	39.7	353.9	74,400			320
330	27.2	306.8	23,000	82,000	32.3	326.8		76,000	36.7	340.8	70,200			330
340	22.7	284.4		77,700	28.6	309.3		71,900	33.4	326.1	66,400			340
350	17.0	255.4		73,600	24.4	288.5		68,100	29.9	309.3	62,700			350
360	7.9	207.0		59,700	19.3	262.4		64,400	25.8	289.7	59,200			360
370					12.1	224.7		60,900	21.0	265.7	55,900			370
380									14.8	233.1	52,700			380

# MLC650 VPC-MAX S-2

ASME B30.5

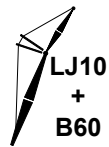

**661,300 lb**

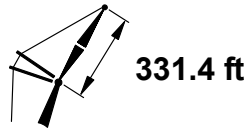
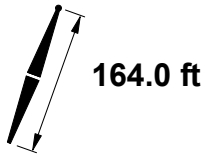

ft	85°				83°				80°				ft
	ft	lb	lb	lb	ft	lb	lb	lb	ft	lb	lb	lb	
115	74.6	492.1	114,700	114,700									115
120	73.7	490.7	114,000	114,000									120
125	72.8	489.1	113,400	113,400									125
130	71.8	487.4	112,800	112,800	72.9	488.6	112,100	112,100					130
135	70.9	485.6	112,100	112,100	72.0	486.9	111,600	111,600					135
140	70.0	483.8	111,400	111,400	71.1	485.2	111,100	111,100					140
145	69.1	481.8	110,600	110,600	70.1	483.3	110,500	110,500					145
150	68.2	479.8	109,800	109,800	69.2	481.4	109,900	109,900					150
155	67.2	477.7	109,100	109,100	68.3	479.4	109,200	109,200	69.9	481.3	106,800	106,800	155
160	66.3	475.5	108,300	108,300	67.3	477.3	108,600	108,600	68.9	479.4	106,500	106,500	160
165	65.3	473.1	107,500	107,500	66.4	475.1	107,900	107,900	68.0	477.3	106,100	106,100	165
170	64.3	470.7	106,700	106,700	65.4	472.7	107,300	107,300	67.1	475.2	105,700	105,700	170
175	63.4	468.2	105,900	105,900	64.5	470.3	106,600	106,600	66.1	472.9	105,300	105,300	175
180	62.4	465.5	105,100	105,100	63.5	467.8	105,900	105,900	65.2	470.6	104,900	104,900	180
185	61.4	462.8	104,300	104,300	62.5	465.2	105,200	105,200	64.2	468.1	104,400	104,400	185
190	60.4	459.9	103,500	103,500	61.6	462.4	104,500	104,500	63.2	465.6	103,900	103,900	190
195	59.4	456.9	102,700	102,700	60.6	459.6	103,900	103,900	62.2	462.9	103,500	103,500	195
200	58.4	453.8	101,900	101,900	59.6	456.6	103,200	103,200	61.3	460.1	100,300	100,300	200
205	57.4	450.6	101,200	101,200	58.5	453.5	102,500	102,500	60.3	457.3	99,900	102,500	205
210	56.3	447.2	100,400	100,400	57.5	450.3	99,700	101,900	59.2	454.3	91,600	102,000	210
215	55.3	443.7	99,700	99,700	56.5	447.0	95,500	101,200	58.2	451.1	87,500	101,500	215
220	54.2	440.1	96,600	98,900	55.4	443.5	91,400	100,500	57.2	447.9	83,600	101,000	220
230	52.0	432.3	88,800	97,500	53.3	436.1	83,800	99,200	55.1	441.0	76,400	100,000	230
240	49.8	424.0	81,600	95,700	51.1	428.1	76,800	98,000	52.9	433.5	69,800	99,000	240
250	47.4	414.9	75,000	91,300	48.8	419.5	70,400	96,700	50.7	425.4	63,600	98,000	250
260	45.0	405.1	68,900	86,800	46.4	410.1	64,500	95,600	48.4	416.7	58,000	97,000	260
270	42.5	394.3	63,200	82,600	43.9	399.9	59,000	94,400	46.0	407.2	52,800	96,100	270
280	39.8	382.6	58,000	78,500	41.3	388.7	53,900	90,000	43.5	396.8	47,900	95,300	280
290	37.0	369.6	53,000	74,700	38.6	376.4	49,200	85,500	40.9	385.5	43,300	94,600	290
300	33.9	355.1	48,400	71,200	35.7	362.9	44,700	81,600	38.2	373.0	39,100	89,700	300
310	30.6	338.8	44,100	68,000	32.5	347.7	40,500	75,400	35.2	359.2	35,100	83,400	310
320	26.9	320.0	40,000	63,900	29.1	330.4	36,500	69,200	32.0	343.8	31,300	76,900	320
330	22.7	297.6	36,100	57,900	25.2	310.2	32,800	62,900	28.5	326.1	27,800	70,500	330
340	17.4	269.0	32,300	52,400	20.6	285.6	29,200	57,000	24.5	305.4	24,400	64,200	340
350	9.6	224.8	28,600	37,500	14.6	252.5	25,700	50,700	19.8	279.9	21,100	58,100	350
360									13.5	244.7		51,700	360
370													370
380													380
390													390
400													400

# MLC650 VPC-MAX S-2

ASME B30.5

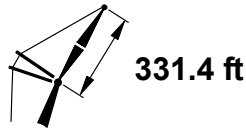
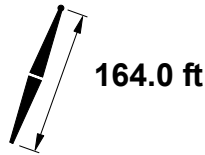
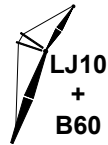

ft	75°				70°				65°				
	ft	lb	ft	lb	ft	lb	ft	lb	ft	lb	ft	lb	
115													115
120													120
125													125
130													130
135													135
140													140
145													145
150													150
155													155
160													160
165													165
170													170
175													175
180													180
185													185
190													190
195	65.0	466.7	90,600	97,300									195
200	64.0	464.2	86,200	97,300									200
205	63.0	461.7	82,100	97,300									205
210	62.0	459.0	78,200	97,300									210
215	61.0	456.2	74,400	97,200									215
220	60.0	453.3	70,900	97,100									220
230	58.0	447.1	64,200	96,800									230
240	55.9	440.4	58,100	96,400	58.8	444.8	46,700	88,400					240
250	53.8	433.1	52,500	96,000	56.7	438.3	41,500	88,400					250
260	51.6	425.3	47,300	95,600	54.6	431.2	36,800	88,400					260
270	49.3	416.8	42,500	95,200	52.4	423.6	32,400	88,400					270
280	47.0	407.6	38,000	94,700	50.2	415.4	28,300	88,400	53.1	420.3	80,800		280
290	44.5	397.6	33,800	94,300	47.8	406.5	24,400	88,400	50.9	412.3	80,800		290
300	42.0	386.7	29,900	93,500	45.4	396.8	20,900	86,800	48.6	403.6	80,300		300
310	39.3	374.7	26,200	88,400	42.9	386.2		82,000	46.2	394.2	75,700		310
320	36.4	361.5	22,800	83,700	40.3	374.6		77,400	43.7	383.9	71,300		320
330	33.3	346.7		79,200	37.5	361.9		73,100	41.1	372.6	67,200		330
340	30.0	330.0		75,000	34.5	347.7		69,100	38.4	360.3	63,400		340
350	26.2	310.6		69,700	31.2	331.7		65,300	35.4	346.6	59,800		350
360	21.8	287.3		63,300	27.6	313.4		61,700	32.3	331.2	56,300		360
370	16.3	257.1		57,300	23.5	291.8		58,200	28.8	313.8	53,100		370
380	7.2	205.5		47,700	18.5	264.6		55,000	24.9	293.3	49,900		380
390					11.4	225.0		51,800	20.2	268.2	47,000		390
400									14.0	234.2	44,100		400

# MLC650 VPC-MAX S-2

ASME B30.5

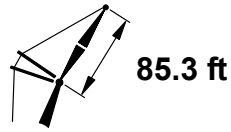
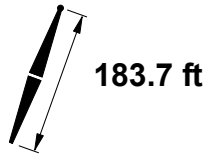

ft	85°				83°				80°				ft
	ft	lb	lb	lb	ft	lb	lb	lb	ft	lb	lb	lb	
55	71.9	273.2	634,700 c	771,600 c									55
60	68.2	271.1	573,100 c	761,000 c	72.9	273.0	555,200 c	771,600 c					60
65	64.5	268.6	521,700 c	732,400 c	69.3	270.9	505,300 c	771,600 c					65
70	60.6	265.7	478,100 b	704,500 b	65.5	268.5	463,100 b	743,400 b					70
75	56.5	262.2	440,700 b	677,900 b	61.7	265.7	426,800 b	700,900 b	68.9	269.1	406,000 b	684,200 b	75
80	52.2	258.2	408,200	652,900	57.7	262.4	395,300 b	648,600 b	65.2	266.7	376,000 b	633,200 b	80
85	47.6	253.6	379,600	613,000	53.5	258.6	367,700	603,300	61.3	263.8	349,700 b	588,900 b	85
90	42.6	248.0	354,300	572,600	49.0	254.2	343,200	563,600	57.3	260.5	326,400 b	550,100 b	90
95	37.1	241.4	331,700	537,000	44.1	248.9	321,400	528,500	53.0	256.6	305,700	515,900	95
100	30.5	233.0	311,200	471,800	38.7	242.6	301,700	497,200	48.5	252.1	287,000	485,400	100
105	22.0	221.4	292,500	389,600	32.4	234.8	283,800	469,200	43.6	246.7	270,100	458,100	105
110					24.7	224.3	267,300	426,600	38.1	240.3	254,700	433,400	110
115					12.0	206.1	251,600	333,000	31.8	232.3	240,600	411,100	115
120									23.8	221.5	227,400	390,600	120
125									9.6	201.0	214,300	333,600	125
130													130
135													135
140													140
145													145
150													150
155													155
160													160
165													165
170													170

# MLC650 VPC-MAX S-2

ASME B30.5

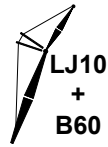

661,300 lb



360°

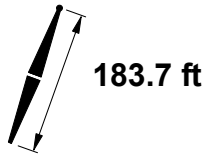

183.7 ft

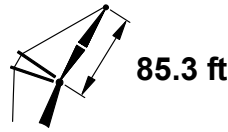

85.3 ft

ft	75°				70°				65°				ft
	ft	°	ft	lb	ft	°	ft	lb	ft	°	ft	lb	
55													55
60													60
65													65
70													70
75													75
80													80
85													85
90													90
95													95
100	61.8	260.5	262,300 b	465,900 b									100
105	57.8	257.2	246,900 b	439,700 b									105
110	53.6	253.4	232,900	416,100									110
115	49.1	249.0	220,000	394,600									115
120	44.2	243.7	208,300	375,100	58.0	252.3	188,600	359,800					120
125	38.9	237.5	197,300	357,200	53.8	248.5	178,700	342,600					125
130	32.7	229.7	187,200	340,800	49.3	244.1	169,600	326,900					130
135	25.0	219.4	177,600	325,600	44.5	238.9	161,100	312,400					135
140	12.6	201.7	168,000	311,200	39.1	232.7	153,100	299,000	53.6	241.9	137,100	286,600	140
145					33.0	225.0	145,600	286,500	49.1	237.4	130,400	274,600	145
150					25.4	214.9	138,400	274,800	44.2	232.2	124,100	263,500	150
155					13.6	198.0	131,100	263,600	38.8	225.9	118,100	253,100	155
160									32.7	218.2	112,400	243,400	160
165									24.9	207.8	106,900	234,100	165
170									12.6	190.2	101,200	225,100	170

# MLC650 VPC-MAX S-2

ASME B30.5



661,300 lb

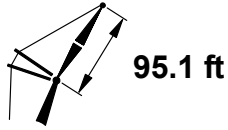
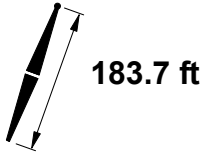

ft	85°				83°				80°				ft
	ft	lb	lb	lb	ft	lb	lb	lb	ft	lb	lb	lb	
55	73.8	283.7	632,200 c	758,200 c									55
60	70.6	281.8	570,700 c	733,300 c									60
65	67.3	279.6	519,400 b	707,700 b	71.5	281.6	502,600 b	752,700 b					65
70	64.0	277.1	475,900 b	682,200 b	68.3	279.5	460,500 b	728,500 b					70
75	60.5	274.1	438,500 b	657,500 b	64.9	277.0	424,300 b	692,600 b					75
80	56.8	270.8	406,100	633,700	61.5	274.2	392,900 b	645,500 b	67.9	277.7	373,100 b	629,900 b	80
85	53.0	266.9	377,700	610,300	57.9	270.9	365,400	600,400	64.6	275.2	346,900 b	585,800 b	85
90	49.0	262.4	352,600	570,100	54.1	267.2	341,000	560,900	61.1	272.3	323,800 b	547,200 b	90
95	44.7	257.3	330,100	534,600	50.2	263.0	319,300	526,000	57.5	269.0	303,100	513,100	95
100	40.0	251.3	309,900	503,100	45.9	258.0	299,800	494,900	53.7	265.2	284,600	482,800	100
105	34.7	244.0	291,700	474,700	41.3	252.3	282,200	467,100	49.8	260.9	267,900	455,600	105
110	28.5	235.0	274,900	425,200	36.2	245.4	266,100	441,900	45.5	255.9	252,700	431,100	110
115	20.4	222.5	259,400	354,300	30.3	237.0	251,400	419,200	40.9	250.1	238,700	408,900	115
120					22.9	225.7	237,700	387,200	35.7	243.1	225,900	388,700	120
125					10.5	205.7	224,300	302,200	29.7	234.4	214,100	370,100	125
130									22.1	222.8	202,900	353,000	130
135									7.9	199.9	191,600	302,100	135
140													140
145													145
150													150
155													155
160													160
165													165
170													170
175													175
180													180

# MLC650 VPC-MAX S-2

ASME B30.5

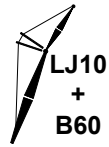

661,300 lb



360°

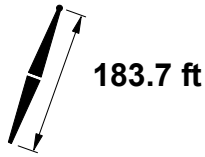

183.7 ft

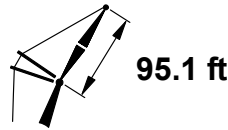

95.1 ft

ft	75°				70°				65°				ft
	ft	°	ft	lb	ft	°	ft	lb	ft	°	ft	lb	
55													55
60													60
65													65
70													70
75													75
80													80
85													85
90													90
95													95
100													100
105	61.6	268.9	243,900	436,800									105
110	58.0	265.7	230,000	413,300									110
115	54.2	262.0	217,300	392,000									115
120	50.3	257.7	205,600	372,600									120
125	46.1	252.8	194,900	354,900	58.2	260.8	175,600	339,900					125
130	41.5	247.1	185,000	338,600	54.4	257.1	166,600	324,300					130
135	36.4	240.3	175,700	323,600	50.5	252.9	158,200	309,900					135
140	30.5	231.9	167,000	309,600	46.3	248.0	150,400	296,600					140
145	23.2	220.8	158,700	296,600	41.7	242.3	143,100	284,200	54.2	250.5	127,200	272,000	145
150	11.1	201.4	150,400	284,300	36.7	235.6	136,200	272,700	50.3	246.2	121,100	261,000	150
155					30.8	227.3	129,700	261,900	46.1	241.3	115,300	250,700	155
160					23.6	216.3	123,400	251,700	41.5	235.6	109,800	241,100	160
165					12.1	197.9	117,000	242,000	36.4	228.8	104,600	232,000	165
170									30.5	220.4	99,600	223,500	170
175									23.2	209.2	94,700	215,300	175
180									11.1	189.9	89,500	207,400	180

# MLC650 VPC-MAX S-2

ASME B30.5

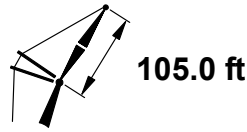
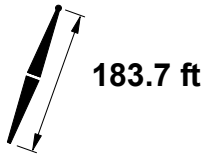
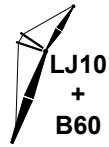

ft	85°				83°				80°				ft
	ft	lb	lb	lb	ft	lb	lb	lb	ft	lb	lb	lb	
60	72.5	292.3	569,400 b	704,300 b									60
65	69.6	290.4	518,100 b	683,000 b									65
70	66.6	288.1	474,700 b	660,100 b	70.4	290.2	459,100 b	702,200 b					70
75	63.5	285.5	437,500 b	637,500 b	67.4	288.0	423,000 b	680,600 b					75
80	60.4	282.6	405,100	615,500	64.4	285.5	391,700 b	643,400 b					80
85	57.1	279.3	376,800	594,300	61.3	282.7	364,200	598,400	67.2	286.2	345,400 b	583,600 b	85
90	53.7	275.5	351,700	563,600	58.0	279.4	340,000	559,100	64.1	283.7	322,300	545,200	90
95	50.1	271.2	329,400	529,800	54.6	275.8	318,400	524,300	61.0	280.8	301,800	511,300	95
100	46.3	266.4	309,400	498,400	51.1	271.7	299,000	493,400	57.7	277.5	283,300	481,100	100
105	42.2	260.8	291,300	469,800	47.4	267.0	281,500	465,700	54.3	273.8	266,700	454,000	105
110	37.7	254.3	274,800	444,700	43.4	261.6	265,600	440,700	50.8	269.7	251,600	429,600	110
115	32.7	246.5	259,700	423,400	39.0	255.4	251,000	418,000	47.0	264.9	237,800	407,600	115
120	26.7	236.8	245,800	382,500	34.2	248.0	237,700	397,400	43.0	259.5	225,200	387,400	120
125	18.9	223.4	232,700	321,000	28.5	239.0	225,300	378,500	38.6	253.1	213,500	369,000	125
130					21.4	226.9	213,700	350,800	33.7	245.6	202,700	352,100	130
135					9.1	205.0	202,200	275,500	27.9	236.4	192,600	336,500	135
140									20.6	223.9	183,000	322,000	140
145									6.2	198.2	173,200	274,300	145
150													150
155													155
160													160
165													165
170													170
175													175
180													180
185													185
190													190



# MLC650 VPC-MAX S-2

ASME B30.5

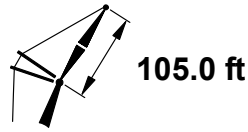
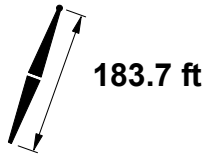
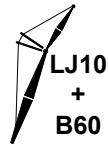

ft	75°				70°				65°				ft
	ft	ft	lb	lb	ft	ft	lb	lb	ft	ft	lb	lb	
60													60
65													65
70													70
75													75
80													80
85													85
90													90
95													95
100													100
105	64.5	280.2	242,200	434,900									105
110	61.4	277.4	228,400	411,500									110
115	58.1	274.2	215,800	390,400									115
120	54.8	270.6	204,200	371,100									120
125	51.2	266.5	193,600	353,400									125
130	47.5	261.8	183,800	337,200	58.3	269.3	164,900	322,600					130
135	43.5	256.4	174,700	322,300	54.9	265.7	156,600	308,300					135
140	39.2	250.2	166,200	308,500	51.4	261.6	149,000	295,100					140
145	34.3	242.9	158,200	295,700	47.7	256.9	141,800	282,800					145
150	28.7	233.9	150,700	283,700	43.7	251.6	135,000	271,400	54.8	259.1	119,400	259,400	150
155	21.7	222.0	143,500	272,500	39.4	245.5	128,700	260,800	51.2	254.9	113,700	249,200	155
160	9.8	200.9	136,100	261,700	34.6	238.2	122,700	250,800	47.5	250.3	108,300	239,700	160
165					29.0	229.3	117,000	241,400	43.5	244.9	103,200	230,700	165
170					22.1	217.6	111,400	232,500	39.2	238.7	98,400	222,300	170
175					10.8	197.6	105,600	223,800	34.3	231.4	93,800	214,300	175
180									28.7	222.4	89,400	206,800	180
185									21.7	210.5	85,000	199,600	185
190									9.8	189.3	80,300	192,500	190

# MLC650 VPC-MAX S-2

ASME B30.5



661,300 lb

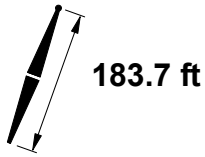

183.7 ft

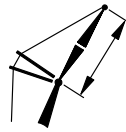

114.8 ft

ft	85°				83°				80°				ft
	ft	lb	lb	lb	ft	lb	lb	lb	ft	lb	lb	lb	
60	74.1	302.7	566,800 b	644,600 b									60
65	71.4	301.0	515,600 b	644,000 b									65
70	68.8	298.9	472,300 b	637,300 b	72.2	300.7	456,300 b	646,600 b					70
75	66.0	296.6	435,100 b	617,000 b	69.5	298.7	420,300 b	646,600 b					75
80	63.2	294.0	402,800	596,700	66.8	296.5	389,000	637,100					80
85	60.3	291.1	374,500	577,100	64.0	294.0	361,700	595,500	69.2	297.0	342,500	580,500	85
90	57.3	287.8	349,500	545,400	61.1	291.1	337,500	556,300	66.5	294.7	319,500	542,200	90
95	54.2	284.1	327,300	514,300	58.2	287.9	315,900	521,600	63.7	292.1	299,000	508,400	95
100	51.0	279.9	307,300	484,600	55.1	284.4	296,600	490,800	60.8	289.2	280,600	478,300	100
105	47.6	275.3	289,300	457,000	51.9	280.4	279,200	463,200	57.9	286.0	264,100	451,400	105
110	44.0	270.0	273,000	431,400	48.5	275.8	263,400	438,300	54.8	282.4	249,100	427,100	110
115	40.1	264.0	258,000	408,400	45.0	270.8	249,000	415,800	51.6	278.3	235,400	405,100	115
120	35.8	257.1	244,300	388,300	41.2	265.0	235,800	395,300	48.2	273.8	222,800	385,100	120
125	31.0	248.8	231,700	371,300	37.0	258.3	223,600	376,500	44.6	268.7	211,300	366,800	125
130	25.3	238.5	219,900	345,800	32.4	250.5	212,300	359,200	40.8	262.8	200,600	350,000	130
135	17.7	224.2	208,700	294,000	27.0	240.8	201,700	343,300	36.6	256.0	190,700	334,500	135
140					20.1	228.0	191,700	321,000	31.9	248.0	181,400	320,100	140
145					7.8	204.0	181,700	250,500	26.4	238.2	172,700	306,800	145
150									19.3	224.9	164,400	294,300	150
155									4.2	195.1	155,600	246,300	155
160													160
165													165
170													170
175													175
180													180
185													185
190													190
195													195
200													200

# MLC650 VPC-MAX S-2

ASME B30.5

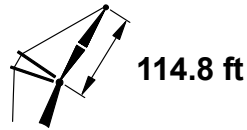
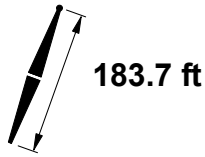
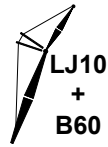

ft	75°				70°				65°				ft
	ft	°	ft	lb	ft	°	ft	lb	ft	°	ft	lb	
60													60
65													65
70													70
75													75
80													80
85													85
90													90
95													95
100													100
105													105
110	64.1	288.7	225,300	408,700									110
115	61.2	285.9	212,800	387,600									115
120	58.2	282.7	201,300	368,400									120
125	55.2	279.1	190,800	350,900									125
130	52.0	275.1	181,100	334,700									130
135	48.6	270.6	172,000	319,900	58.4	277.8	153,500	305,600					135
140	45.1	265.6	163,700	306,200	55.3	274.2	145,900	292,500					140
145	41.3	259.8	155,800	293,400	52.2	270.2	138,800	280,300					145
150	37.1	253.2	148,500	281,600	48.8	265.8	132,200	269,000					150
155	32.5	245.4	141,500	270,500	45.3	260.8	125,900	258,400					155
160	27.1	235.8	134,900	260,100	41.5	255.0	120,100	248,500	52.0	263.6	105,200	237,100	160
165	20.3	223.2	128,600	250,300	37.4	248.5	114,500	239,200	48.6	259.1	100,200	228,200	165
170	8.6	200.1	122,000	240,900	32.8	240.7	109,200	230,400	45.1	254.1	95,500	219,900	170
175					27.4	231.3	104,100	222,200	41.3	248.3	91,000	212,000	175
180					20.7	218.8	99,200	214,300	37.1	241.7	86,800	204,600	180
185					9.6	197.1	94,000	206,600	32.5	233.9	82,700	197,500	185
190									27.1	224.3	78,700	190,800	190
195									20.3	211.6	74,800	184,400	195
200									8.5	188.5	70,500	178,000	200

# MLC650 VPC-MAX S-2

ASME B30.5

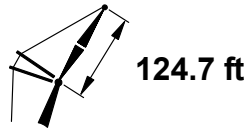
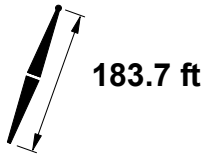

ft	85°				83°				80°				ft
	ft	lb	lb	lb	ft	lb	lb	lb	ft	lb	lb	lb	
65	73.0	311.4	547,200 b	592,700 b									65
70	70.5	309.6	501,400 b	591,400 b									70
75	68.0	307.5	462,200	588,100	71.2	309.3	447,300 b	595,200 b					75
80	65.5	305.1	428,200	579,900	68.7	307.3	414,300	595,200					80
85	62.9	302.5	398,400	556,000	66.2	305.0	385,400	592,400					85
90	60.2	299.5	372,100	527,900	63.6	302.5	359,900	555,500	68.5	305.5	341,700	541,400	90
95	57.5	296.3	348,600	500,000	61.0	299.6	337,200	521,000	66.0	303.2	320,000	507,700	95
100	54.7	292.6	327,700	472,800	58.3	296.4	316,800	490,300	63.4	300.6	300,600	477,700	100
105	51.7	288.6	308,700	446,700	55.4	292.9	298,400	462,800	60.7	297.7	283,100	450,900	105
110	48.6	284.1	291,600	422,200	52.5	289.0	281,800	438,000	58.0	294.5	267,200	426,700	110
115	45.4	279.1	275,900	399,400	49.5	284.6	266,700	415,500	55.2	291.0	252,800	404,800	115
120	41.9	273.5	261,600	378,400	46.3	279.8	252,800	395,100	52.2	287.0	239,600	384,800	120
125	38.2	267.1	248,400	359,700	42.9	274.3	240,000	376,400	49.2	282.6	227,400	366,600	125
130	34.1	259.7	236,200	343,300	39.2	268.2	228,200	359,300	46.0	277.7	216,200	349,900	130
135	29.4	250.9	224,800	329,600	35.3	261.1	217,300	343,400	42.6	272.2	205,800	334,500	135
140	23.9	240.1	214,200	311,300	30.8	252.8	207,100	328,800	38.9	265.9	196,200	320,200	140
145	16.6	224.9	204,000	272,200	25.6	242.6	197,500	315,200	34.9	258.8	187,100	307,000	145
150					18.9	229.0	188,300	292,100	30.3	250.3	178,600	294,600	150
155					6.6	202.6	179,100	228,800	25.0	239.9	170,600	283,100	155
160									18.2	225.8	162,900	272,300	160
165													165
170													170
175													175
180													180
185													185
190													190
195													195
200													200
205													205
210													210

# MLC650 VPC-MAX S-2

ASME B30.5

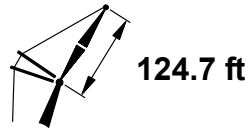
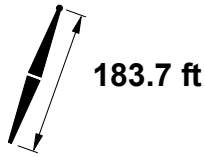
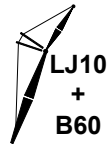

ft	75°				70°				65°				ft
	ft	ft	lb	lb	ft	ft	lb	lb	ft	ft	lb	lb	
65													65
70													70
75													75
80													80
85													85
90													90
95													95
100													100
105													105
110													110
115	63.7	297.2	229,900	387,200									115
120	61.1	294.4	217,800	368,000									120
125	58.3	291.2	206,600	350,500									125
130	55.5	287.7	196,300	334,500									130
135	52.6	283.8	186,800	319,700									135
140	49.6	279.4	177,900	306,100	58.5	286.3	159,900	292,200					140
145	46.4	274.6	169,700	293,400	55.7	282.8	152,300	280,100					145
150	43.0	269.2	162,000	281,600	52.8	278.9	145,300	268,800					150
155	39.4	263.0	154,700	270,600	49.7	274.6	138,700	258,300					155
160	35.4	256.0	147,900	260,300	46.6	269.8	132,500	248,500					160
165	30.9	247.7	141,400	250,600	43.2	264.4	126,700	239,200	52.6	272.3	112,000	228,100	165
170	25.8	237.6	135,200	241,500	39.5	258.3	121,100	230,600	49.6	267.9	107,000	219,800	170
175	19.2	224.2	129,200	232,900	35.6	251.2	115,900	222,400	46.4	263.1	102,300	212,000	175
180	7.4	199.0	123,000	224,500	31.2	243.0	110,900	214,700	43.0	257.7	97,800	204,600	180
185					26.0	233.0	106,000	207,300	39.4	251.5	93,500	197,700	185
190					19.6	219.9	101,300	200,300	35.4	244.5	89,400	191,100	190
195					8.5	196.3	96,400	193,500	30.9	236.2	85,500	184,800	195
200									25.8	226.1	81,700	178,800	200
205									19.2	212.6	77,900	173,000	205
210									7.3	187.4	73,800	167,300	210

# MLC650 VPC-MAX S-2

ASME B30.5



661,300 lb

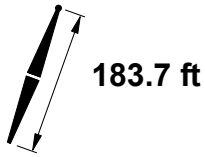

183.7 ft



134.5 ft

ft	85°				83°				80°				ft
	ft	lb	lb	lb	ft	lb	lb	lb	ft	lb	lb	lb	
65	74.3	321.8	543,300 b	543,300 b									65
70	72.0	320.1	499,000	543,300									70
75	69.7	318.2	459,800	542,300	72.6	319.8	444,600	543,100					75
80	67.4	316.0	425,800	538,900	70.4	317.9	411,700	543,100					80
85	65.1	313.6	396,000	532,300	68.1	315.9	382,800	543,100					85
90	62.6	311.0	369,800	508,200	65.7	313.5	357,300	543,100					90
95	60.2	308.0	346,400	483,800	63.3	310.9	334,700	518,300	67.8	314.1	317,200	504,800	95
100	57.6	304.8	325,400	459,400	60.9	308.1	314,300	487,700	65.5	311.7	297,800	475,000	100
105	55.0	301.2	306,500	435,600	58.4	304.9	296,000	460,300	63.1	309.1	280,400	448,200	105
110	52.3	297.3	289,400	412,700	55.8	301.4	279,500	435,600	60.6	306.2	264,600	424,100	110
115	49.5	292.9	273,800	390,900	53.1	297.6	264,300	413,200	58.1	303.0	250,200	402,300	115
120	46.5	288.1	259,600	370,500	50.3	293.4	250,500	392,900	55.5	299.5	237,000	382,400	120
125	43.4	282.8	246,400	351,600	47.4	288.7	237,800	374,300	52.8	295.6	224,900	364,300	125
130	40.1	276.8	234,300	334,300	44.3	283.5	226,100	357,200	50.0	291.4	213,800	347,600	130
135	36.5	270.0	223,100	318,900	41.0	277.7	215,300	341,400	47.1	286.6	203,500	332,300	135
140	32.6	262.2	212,700	305,400	37.5	271.2	205,200	326,800	44.0	281.4	193,900	318,100	140
145	28.1	253.0	202,900	294,300	33.7	263.7	195,700	313,300	40.7	275.5	184,900	304,900	145
150	22.8	241.5	193,600	280,100	29.4	254.9	186,900	300,700	37.2	268.9	176,600	292,700	150
155	15.6	225.4	184,700	246,700	24.4	244.2	178,500	289,000	33.3	261.3	168,700	281,200	155
160					17.9	229.9	170,500	263,400	29.0	252.4	161,300	270,500	160
165					5.2	200.5	162,200	204,200	23.8	241.4	154,200	260,400	165
170									17.1	226.6	147,400	250,900	170
175													175
180													180
185													185
190													190
195													195
200													200
205													205
210													210
215													215
220													220

# MLC650 VPC-MAX S-2

ASME B30.5

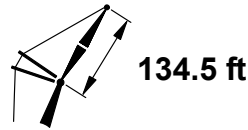
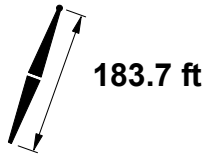

ft	75°				70°				65°				ft
	ft	°	ft	lb	ft	°	ft	lb	ft	°	ft	lb	
65													65
70													70
75													75
80													80
85													85
90													90
95													95
100													100
105													105
110													110
115													115
120	63.4	305.7	214,700	365,300									120
125	60.9	302.8	203,600	347,900									125
130	58.4	299.7	193,400	332,000									130
135	55.8	296.2	183,900	317,200									135
140	53.2	292.4	175,200	303,600									140
145	50.4	288.2	167,000	291,000	58.6	294.7	149,200	277,500					145
150	47.5	283.5	159,300	279,300	56.0	291.3	142,300	266,300					150
155	44.4	278.3	152,200	268,400	53.3	287.5	135,700	255,800					155
160	41.1	272.6	145,400	258,200	50.5	283.3	129,600	246,000					160
165	37.7	266.1	139,100	248,600	47.6	278.7	123,800	236,900					165
170	33.8	258.6	133,100	239,500	44.6	273.5	118,400	228,300	53.2	280.9	103,900	217,300	170
175	29.5	249.9	127,300	231,000	41.3	267.8	113,200	220,100	50.4	276.7	99,300	209,500	175
180	24.5	239.2	121,800	223,000	37.8	261.3	108,300	212,500	47.5	272.0	94,800	202,200	180
185	18.1	225.1	116,500	215,300	34.0	253.9	103,700	205,300	44.4	266.8	90,600	195,300	185
190	6.2	197.5	110,800	207,800	29.8	245.2	99,200	198,400	41.1	261.0	86,600	188,800	190
195					24.8	234.7	94,900	191,800	37.6	254.5	82,800	182,600	195
200					18.5	220.8	90,600	185,600	33.8	247.1	79,100	176,600	200
205					7.4	195.3	86,100	179,400	29.5	238.3	75,600	171,000	205
210									24.5	227.7	72,100	165,600	210
215									18.1	213.5	68,700	160,400	215
220									6.2	185.9	64,900	155,200	220

# MLC650 VPC-MAX S-2

ASME B30.5



661,300 lb



360°

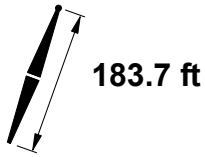

183.7 ft



144.4 ft

ft	85°				83°				80°				ft
	ft	lb	lb	lb	ft	lb	lb	lb	ft	lb	lb	lb	
70	73.3	330.5	497,200	500,000									70
75	71.2	328.7	458,000	499,800									75
80	69.1	326.8	424,100	498,100	71.8	328.5	409,800	501,000					80
85	66.9	324.6	394,300	494,500	69.7	326.5	381,000	501,000					85
90	64.7	322.1	368,100	486,900	67.5	324.4	355,500	501,000					90
95	62.4	319.4	344,700	465,900	65.3	322.0	332,900	501,000	69.4	324.8	315,200	490,800	95
100	60.1	316.5	323,800	444,400	63.1	319.4	312,600	485,700	67.3	322.6	295,900	472,800	100
105	57.8	313.3	304,900	423,100	60.8	316.5	294,300	458,300	65.1	320.2	278,500	446,200	105
110	55.3	309.7	287,900	402,100	58.4	313.4	277,800	433,700	62.8	317.6	262,700	422,200	110
115	52.8	305.9	272,300	381,900	56.0	310.0	262,700	411,400	60.5	314.7	248,400	400,400	115
120	50.2	301.6	258,100	362,500	53.5	306.2	248,900	391,100	58.2	311.5	235,200	380,600	120
125	47.5	297.0	245,000	344,300	51.0	302.1	236,300	372,600	55.8	308.0	223,200	362,500	125
130	44.7	291.9	233,000	327,200	48.3	297.6	224,600	355,500	53.3	304.2	212,100	345,900	130
135	41.7	286.2	221,800	311,500	45.5	292.6	213,800	339,800	50.7	300.1	201,800	330,600	135
140	38.5	279.9	211,400	297,100	42.5	287.1	203,800	325,300	48.0	295.5	192,300	316,400	140
145	35.0	272.8	201,800	284,400	39.4	280.9	194,400	311,900	45.2	290.5	183,400	303,300	145
150	31.2	264.6	192,700	273,300	36.0	274.0	185,700	299,300	42.2	284.9	175,100	291,100	150
155	26.9	254.9	184,200	264,100	32.3	266.2	177,500	287,700	39.1	278.7	167,300	279,800	155
160	21.7	242.8	176,100	253,400	28.2	257.0	169,700	276,700	35.7	271.7	160,000	269,100	160
165	14.7	225.9	168,300	223,400	23.3	245.7	162,400	264,600	31.9	263.8	153,100	259,100	165
170					17.0	230.6	155,300	238,900	27.7	254.4	146,500	249,700	170
175					3.4	197.0	147,800	181,500	22.7	242.9	140,300	240,900	175
180									16.2	227.2	134,200	232,500	180
185													185
190													190
195													195
200													200
205													205
210													210
215													215
220													220
230													230



# MLC650 VPC-MAX S-2

ASME B30.5

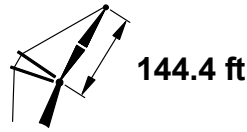
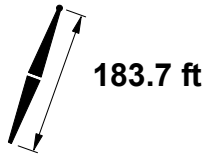

ft	75°				70°				65°				ft
	ft	°	ft	lb	ft	°	ft	lb	ft	°	ft	lb	
70													70
75													75
80													80
85													85
90													90
95													95
100													100
105													105
110													110
115													115
120													120
125	63.1	314.2	201,600	346,000									125
130	60.8	311.3	191,400	330,100									130
135	58.5	308.2	182,000	315,400									135
140	56.1	304.7	173,300	301,900									140
145	53.6	301.0	165,100	289,300									145
150	51.0	296.9	157,500	277,600	58.6	303.2	140,200	264,500					150
155	48.4	292.4	150,400	266,700	56.2	299.8	133,700	254,000					155
160	45.6	287.4	143,700	256,600	53.7	296.1	127,600	244,300					160
165	42.6	281.9	137,400	247,000	51.2	292.0	121,900	235,200					165
170	39.5	275.8	131,500	238,100	48.5	287.5	116,500	226,600					170
175	36.1	268.9	125,900	229,600	45.7	282.5	111,400	218,500	53.6	289.5	97,200	207,800	175
180	32.4	261.1	120,500	221,700	42.8	277.1	106,600	210,900	51.0	285.3	92,800	200,500	180
185	28.3	251.9	115,400	214,100	39.7	271.0	102,000	203,800	48.4	280.8	88,700	193,700	185
190	23.4	240.7	110,500	207,000	36.3	264.2	97,600	196,900	45.6	275.9	84,800	187,200	190
195	17.2	225.9	105,700	200,100	32.6	256.4	93,400	190,500	42.6	270.4	81,000	181,000	195
200	4.9	195.3	100,500	193,300	28.5	247.3	89,400	184,300	39.5	264.3	77,400	175,100	200
205					23.7	236.3	85,500	178,500	36.1	257.4	74,000	169,600	205
210					17.6	221.6	81,600	172,800	32.4	249.6	70,600	164,300	210
215					6.4	193.9	77,400	167,200	28.3	240.4	67,400	159,200	215
220									23.4	229.2	64,300	154,300	220
230									4.8	183.7	57,600	144,700	230

# MLC650 VPC-MAX S-2

ASME B30.5

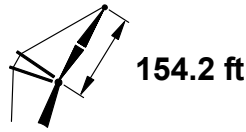
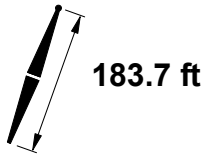

ft	85°				83°				80°				ft
	ft	lb	lb	lb	ft	lb	lb	lb	ft	lb	lb	lb	
70	74.4	340.8	459,500	459,500									70
75	72.4	339.2	459,500	459,500									75
80	70.5	337.4	446,800	459,500	73.0	338.9	432,200	457,800					80
85	68.5	335.3	415,500	457,600	71.0	337.1	401,900	457,800					85
90	66.4	333.1	387,900	454,300	69.0	335.1	375,100	457,800					90
95	64.4	330.6	363,300	447,200	67.0	332.9	351,200	457,800					95
100	62.2	327.9	341,300	428,800	64.9	330.5	329,900	457,800	68.8	333.3	312,900	451,300	100
105	60.1	325.0	321,500	410,100	62.8	327.9	310,700	455,900	66.8	331.1	294,500	443,500	105
110	57.9	321.8	303,600	391,300	60.7	325.0	293,300	431,300	64.7	328.7	277,900	419,600	110
115	55.6	318.3	287,200	372,900	58.5	321.9	277,400	409,100	62.6	326.0	262,800	397,900	115
120	53.3	314.5	272,300	355,000	56.2	318.5	262,900	388,900	60.5	323.1	248,900	378,200	120
125	50.9	310.3	258,600	337,700	53.9	314.8	249,600	370,400	58.3	320.0	236,300	360,100	125
130	48.4	305.8	245,900	321,400	51.6	310.7	237,400	353,400	56.0	316.5	224,600	343,600	130
135	45.8	300.9	234,300	306,000	49.1	306.3	226,000	337,700	53.7	312.8	213,800	328,300	135
140	43.0	295.5	223,400	291,600	46.5	301.5	215,500	323,300	51.3	308.7	203,700	314,200	140
145	40.1	289.5	213,300	278,400	43.8	296.3	205,700	309,900	48.8	304.3	194,400	301,200	145
150	37.0	282.9	203,900	266,500	41.0	290.5	196,600	297,400	46.2	299.5	185,700	289,000	150
155	33.7	275.4	195,000	255,700	37.9	284.0	188,000	285,800	43.5	294.1	177,500	277,700	155
160	30.0	266.8	186,700	246,500	34.7	276.8	180,000	274,900	40.7	288.3	169,900	267,100	160
165	25.8	256.7	178,800	238,900	31.1	268.5	172,400	264,700	37.6	281.8	162,700	257,200	165
170	20.8	244.1	171,200	229,900	27.0	258.9	165,200	255,100	34.3	274.4	155,900	247,800	170
175	13.9	226.3	163,900	202,500	22.3	247.1	158,300	240,000	30.7	266.1	149,400	239,100	175
180					16.1	231.3	151,700	217,000	26.6	256.3	143,300	230,800	180
185									21.8	244.2	137,400	222,900	185
190									15.4	227.8	131,600	215,400	190
195													195
200													200
205													205
210													210
215													215
220													220
230													230
240													240

# MLC650 VPC-MAX S-2

ASME B30.5

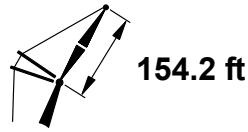
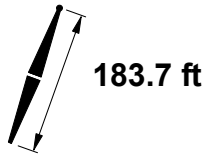

ft	75°				70°				65°				ft
	ft	°	ft	lb	ft	°	ft	lb	ft	°	ft	lb	
70													70
75													75
80													80
85													85
90													90
95													95
100													100
105													105
110													110
115													115
120													120
125	65.0	325.3	214,200	343,400									125
130	62.9	322.6	203,500	327,500									130
135	60.8	319.8	193,500	312,900									135
140	58.6	316.6	184,300	299,400									140
145	56.3	313.2	175,700	286,900									145
150	54.0	309.5	167,700	275,300									150
155	51.6	305.5	160,200	264,500	58.7	311.7	143,100	251,500					155
160	49.2	301.1	153,200	254,300	56.4	308.3	136,700	241,800					160
165	46.6	296.3	146,600	244,800	54.1	304.6	130,600	232,800					165
170	43.9	291.1	140,300	235,900	51.7	300.6	124,900	224,200					170
175	41.0	285.3	134,400	227,500	49.3	296.3	119,600	216,200					175
180	38.0	278.9	128,900	219,600	46.7	291.5	114,500	208,700	54.0	298.0	100,400	198,000	180
185	34.8	271.7	123,500	212,100	44.0	286.3	109,700	201,500	51.6	294.0	96,000	191,200	185
190	31.2	263.5	118,500	205,000	41.2	280.5	105,100	194,800	49.2	289.6	91,800	184,700	190
195	27.2	253.9	113,600	198,300	38.2	274.1	100,700	188,300	46.6	284.8	87,900	178,600	195
200	22.4	242.2	109,000	191,900	34.9	266.9	96,500	182,300	43.9	279.6	84,100	172,800	200
205	16.4	226.6	104,400	185,700	31.4	258.8	92,500	176,500	41.0	273.8	80,500	167,300	205
210	3.1	191.4	99,200	179,600	27.4	249.3	88,600	170,900	38.0	267.4	77,000	162,000	210
215					22.7	237.7	84,900	165,600	34.8	260.1	73,700	157,000	215
220					16.7	222.4	81,100	160,500	31.2	251.9	70,500	152,200	220
230									22.4	230.6	64,300	143,200	230
240									3.1	179.7	57,600	134,400	240

# MLC650 VPC-MAX S-2

ASME B30.5

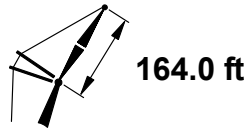
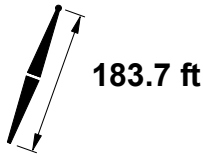

ft	85°				83°				80°				ft
	ft	lb	lb	lb	ft	lb	lb	lb	ft	lb	lb	lb	
75	73.5	349.6	423,300	423,300									75
80	71.7	347.9	423,100	423,100									80
85	69.8	346.0	414,900	421,900	72.2	347.6	401,200	421,100					85
90	67.9	343.9	387,300	420,100	70.3	345.7	374,400	421,100					90
95	66.0	341.6	362,800	417,300	68.5	343.7	350,600	421,100					95
100	64.1	339.1	340,800	411,400	66.5	341.5	329,300	421,100					100
105	62.1	336.4	321,000	395,100	64.6	339.0	310,100	421,100	68.3	341.9	293,700	416,600	105
110	60.0	333.4	303,100	378,500	62.6	336.4	292,700	421,100	66.4	339.6	277,100	416,600	110
115	58.0	330.2	286,800	361,900	60.6	333.5	276,800	408,100	64.4	337.2	262,000	396,900	115
120	55.9	326.8	271,900	345,600	58.6	330.4	262,400	387,900	62.4	334.5	248,300	377,200	120
125	53.7	323.1	258,200	329,700	56.5	327.0	249,100	369,500	60.4	331.6	235,600	359,200	125
130	51.4	319.0	245,600	314,200	54.3	323.3	236,900	352,600	58.4	328.5	223,900	342,700	130
135	49.1	314.6	233,900	299,500	52.1	319.4	225,600	337,000	56.2	325.1	213,200	327,500	135
140	46.7	309.8	223,100	285,600	49.8	315.1	215,100	322,500	54.1	321.4	203,200	313,400	140
145	44.2	304.7	213,000	272,600	47.4	310.4	205,300	309,200	51.8	317.4	193,900	300,400	145
150	41.5	299.0	203,600	260,400	44.9	305.4	196,200	296,700	49.5	313.1	185,200	288,300	150
155	38.7	292.7	194,800	249,200	42.3	299.8	187,700	285,200	47.1	308.4	177,100	277,000	155
160	35.7	285.7	186,600	239,000	39.5	293.7	179,700	274,300	44.6	303.2	169,500	266,500	160
165	32.5	277.9	178,800	230,000	36.6	287.0	172,200	264,200	42.0	297.7	162,300	256,600	165
170	28.9	268.9	171,400	222,100	33.4	279.4	165,100	254,600	39.2	291.5	155,600	247,300	170
175	24.8	258.4	164,500	215,700	29.9	270.8	158,400	245,600	36.3	284.7	149,200	238,500	175
180	19.9	245.2	157,800	210,600	26.0	260.7	152,000	237,200	33.1	277.0	143,100	230,300	180
185	13.2	226.5	151,200	185,400	21.4	248.4	145,800	219,900	29.6	268.3	137,400	222,500	185
190					15.4	231.9	139,900	199,100	25.6	258.0	131,900	215,100	190
195									20.9	245.5	126,600	208,100	195
200									14.6	228.3	121,400	201,300	200
205													205
210													210
215													215
220													220
230													230
240													240

# MLC650 VPC-MAX S-2

ASME B30.5

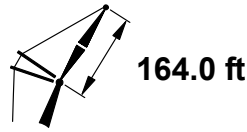
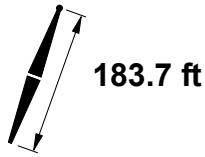

ft	75°				70°				65°				ft
	ft	°	ft	lb	ft	°	ft	lb	ft	°	ft	lb	
75													75
80													80
85													85
90													90
95													95
100													100
105													105
110													110
115													115
120													120
125													125
130	64.7	333.8	202,600	326,500									130
135	62.7	331.1	192,700	312,000									135
140	60.7	328.2	183,500	298,500									140
145	58.6	325.1	174,900	286,000									145
150	56.5	321.8	166,900	274,400									150
155	54.4	318.1	159,500	263,600									155
160	52.1	314.2	152,500	253,500	58.7	320.2	135,800	240,900					160
165	49.8	309.9	145,900	244,100	56.6	316.8	129,800	231,900					165
170	47.4	305.2	139,700	235,200	54.5	313.2	124,100	223,400					170
175	45.0	300.2	133,900	226,800	52.2	309.3	118,800	215,400					175
180	42.4	294.6	128,300	219,000	49.9	305.0	113,700	207,900					180
185	39.6	288.6	123,100	211,500	47.6	300.4	108,900	200,800	54.4	306.6	95,100	190,400	185
190	36.7	281.8	118,100	204,500	45.1	295.3	104,400	194,100	52.1	302.6	91,000	183,900	190
195	33.5	274.3	113,300	197,800	42.5	289.8	100,100	187,700	49.8	298.4	87,000	177,800	195
200	30.1	265.7	108,800	191,500	39.8	283.8	95,900	181,600	47.4	293.7	83,300	172,100	200
205	26.1	255.7	104,400	185,400	36.8	277.1	92,000	175,900	45.0	288.7	79,700	166,600	205
210	21.5	243.5	100,200	179,600	33.7	269.6	88,200	170,400	42.4	283.1	76,300	161,400	210
215	15.6	227.2	96,000	174,000	30.2	261.1	84,600	165,200	39.6	277.0	73,000	156,400	215
220					26.4	251.1	81,100	160,100	36.7	270.3	69,900	151,600	220
230					15.9	223.0	74,200	150,700	30.1	254.2	63,900	142,700	230
240									21.5	232.0	58,300	134,400	240

# MLC650 VPC-MAX S-2

ASME B30.5



661,300 lb

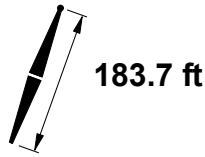

183.7 ft

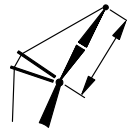

173.9 ft

ft	85°				83°				80°				ft
	ft	lb	lb	lb	ft	lb	lb	lb	ft	lb	lb	lb	
75	74.5	359.9	390,600	390,600									75
80	72.8	358.3	390,600	390,600									80
85	71.0	356.5	390,300	390,300									85
90	69.3	354.6	384,900	389,100	71.5	356.2	371,800	389,000					90
95	67.5	352.4	360,400	387,500	69.7	354.3	348,000	389,000					95
100	65.6	350.1	338,500	385,100	68.0	352.3	326,700	389,000					100
105	63.8	347.6	318,700	379,500	66.2	350.0	307,500	389,000	69.6	352.5	291,000	379,000	105
110	61.9	344.9	300,800	365,100	64.3	347.5	290,200	389,000	67.8	350.4	274,400	379,000	110
115	60.0	341.9	284,500	350,500	62.5	344.9	274,400	388,700	66.0	348.2	259,300	379,000	115
120	58.1	338.7	269,600	335,900	60.5	342.0	260,000	385,700	64.1	345.7	245,600	374,800	120
125	56.1	335.3	256,000	321,400	58.6	338.9	246,700	367,300	62.3	343.0	233,000	356,800	125
130	54.0	331.6	243,400	307,200	56.6	335.5	234,500	350,400	60.4	340.1	221,300	340,400	130
135	51.9	327.7	231,700	293,500	54.6	331.9	223,200	334,800	58.4	337.0	210,600	325,200	135
140	49.7	323.4	221,000	280,300	52.5	328.0	212,800	320,500	56.4	333.6	200,600	311,200	140
145	47.5	318.7	210,900	267,800	50.4	323.8	203,100	307,100	54.4	329.9	191,400	298,200	145
150	45.2	313.7	201,600	255,900	48.1	319.3	194,000	294,700	52.3	326.0	182,700	286,200	150
155	42.7	308.2	192,800	244,800	45.8	314.4	185,500	283,200	50.1	321.8	174,600	274,900	155
160	40.2	302.3	184,600	234,400	43.4	309.0	177,600	272,400	47.9	317.2	167,100	264,400	160
165	37.4	295.7	176,900	225,000	40.9	303.2	170,100	262,300	45.6	312.3	159,900	254,500	165
170	34.5	288.5	169,600	216,300	38.2	296.8	163,000	251,400	43.2	306.9	153,200	245,300	170
175	31.4	280.3	162,700	208,700	35.4	289.8	156,400	241,200	40.6	301.0	146,900	236,600	175
180	27.9	271.0	156,100	202,100	32.3	281.9	150,100	231,900	38.0	294.6	140,900	228,400	180
185	23.9	260.0	149,900	196,800	28.9	272.9	144,100	223,700	35.1	287.5	135,200	220,600	185
190	19.1	246.3	143,900	191,900	25.1	262.4	138,300	216,700	32.0	279.5	129,800	213,300	190
195	12.5	226.7	138,000	168,500	20.6	249.7	132,800	200,400	28.6	270.4	124,700	206,300	195
200					14.6	232.4	127,400	181,600	24.7	259.7	119,700	199,700	200
205									20.1	246.7	114,900	193,400	205
210									13.9	228.7	110,200	185,000	210
215													215
220													220
230													230
240													240
250													250

# MLC650 VPC-MAX S-2

ASME B30.5

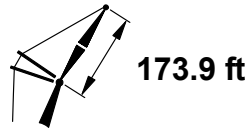
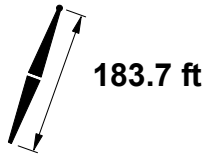

ft	75°				70°				65°				ft
	ft	lb	lb	lb	ft	lb	lb	lb	ft	lb	lb	lb	
75													75
80													80
85													85
90													90
95													95
100													100
105													105
110													110
115													115
120													120
125													125
130													130
135	64.4	342.3	189,700	309,400									135
140	62.5	339.6	180,600	296,000									140
145	60.6	336.7	172,100	283,600									145
150	58.7	333.6	164,100	272,100									150
155	56.7	330.3	156,700	261,300									155
160	54.7	326.7	149,700	251,200									160
165	52.6	322.8	143,200	241,800	58.8	328.7	126,800	229,400					165
170	50.4	318.6	137,100	233,000	56.8	325.3	121,200	221,000					170
175	48.2	314.1	131,200	224,700	54.8	321.7	115,900	213,000					175
180	45.9	309.2	125,800	216,800	52.7	317.9	110,800	205,500					180
185	43.5	303.8	120,600	209,400	50.5	313.7	106,100	198,500					185
190	41.0	298.0	115,600	202,400	48.3	309.2	101,600	191,800	54.7	315.1	87,900	181,500	190
195	38.3	291.7	110,900	195,800	46.0	304.3	97,300	185,400	52.6	311.3	84,000	175,400	195
200	35.5	284.7	106,400	189,500	43.6	299.0	93,200	179,400	50.4	307.1	80,300	169,700	200
205	32.4	276.8	102,200	183,500	41.1	293.2	89,300	173,700	48.2	302.5	76,800	164,200	205
210	29.0	267.9	98,000	177,800	38.4	286.9	85,600	168,300	45.9	297.6	73,400	159,000	210
215	25.2	257.4	94,100	172,300	35.6	279.9	82,100	163,100	43.5	292.3	70,200	154,100	215
220	20.7	244.8	90,200	167,000	32.6	272.1	78,600	158,100	41.0	286.5	67,100	149,400	220
230					25.4	252.9	72,100	148,800	35.5	273.1	61,300	140,500	230
240					15.2	223.6	65,800	140,100	29.0	256.3	55,800	132,400	240
250									20.7	233.2	50,600	124,800	250

# MLC650 VPC-MAX S-2

ASME B30.5

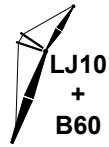

661,300 lb

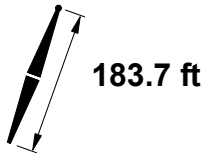

183.7 ft



193.6 ft

ft	85°				83°				80°				ft
	ft	lb	lb	lb	ft	lb	lb	lb	ft	lb	lb	lb	
80	74.6	378.9	332,300	332,300									80
85	73.0	377.4	332,300	332,300									85
90	71.5	375.6	331,800	331,800									90
95	69.9	373.8	331,100	331,100	71.9	375.3	330,500	330,500					95
100	68.3	371.7	330,100	330,100	70.3	373.5	323,400	330,500					100
105	66.7	369.5	315,700	328,800	68.7	371.5	304,300	330,500					105
110	65.0	367.1	297,800	327,400	67.1	369.3	287,000	330,500					110
115	63.4	364.6	281,600	325,100	65.5	367.0	271,200	330,300	68.6	369.7	255,800	321,700	115
120	61.7	361.8	266,700	314,300	63.8	364.5	256,800	329,900	67.0	367.5	242,100	321,700	120
125	60.0	358.9	253,100	302,900	62.1	361.8	243,600	329,100	65.3	365.2	229,500	321,700	125
130	58.2	355.7	240,500	291,500	60.4	358.9	231,400	329,000	63.7	362.7	217,900	321,700	130
135	56.4	352.3	229,000	280,100	58.7	355.8	220,200	322,700	62.0	359.9	207,200	321,700	135
140	54.6	348.7	218,200	268,800	56.9	352.5	209,800	311,300	60.3	357.0	197,300	308,100	140
145	52.7	344.9	208,200	257,800	55.1	349.0	200,100	299,900	58.5	353.9	188,100	295,200	145
150	50.8	340.8	198,900	247,100	53.3	345.2	191,100	288,400	56.8	350.6	179,500	283,100	150
155	48.8	336.3	190,200	236,900	51.4	341.1	182,700	277,100	54.9	347.0	171,500	272,000	155
160	46.8	331.6	182,000	227,100	49.4	336.8	174,800	265,900	53.1	343.2	163,900	261,500	160
165	44.7	326.5	174,400	217,700	47.4	332.2	167,300	255,100	51.2	339.1	156,900	251,700	165
170	42.5	321.0	167,200	208,900	45.3	327.2	160,400	244,600	49.2	334.8	150,200	242,500	170
175	40.2	315.0	160,300	200,700	43.1	321.8	153,800	234,700	47.2	330.1	144,000	233,900	175
180	37.8	308.6	153,900	193,100	40.8	315.9	147,500	225,200	45.1	325.1	138,000	225,700	180
185	35.2	301.5	147,800	186,100	38.4	309.6	141,600	216,300	42.9	319.6	132,400	218,000	185
190	32.4	293.6	142,000	179,700	35.9	302.7	136,000	208,000	40.6	313.8	127,100	210,700	190
195	29.4	284.8	136,500	174,000	33.2	295.1	130,700	200,300	38.2	307.4	122,000	203,800	195
200	26.1	274.8	131,200	169,100	30.3	286.6	125,600	193,400	35.7	300.4	117,200	197,300	200
205	22.3	262.9	126,100	165,300	27.1	276.9	120,700	187,300	33.0	292.7	112,600	191,100	205
210	17.7	248.2	121,200	161,600	23.4	265.7	116,100	182,100	30.0	284.1	108,200	185,100	210
215	11.2	226.7	116,300	141,100	19.1	251.9	111,500	169,000	26.8	274.3	104,000	179,500	215
220					13.4	233.1	107,000	153,100	23.1	262.9	99,900	174,100	220
230									12.6	229.2	91,900	156,200	230
240													240
250													250
260													260
270													270



# MLC650 VPC-MAX S-2

ASME B30.5

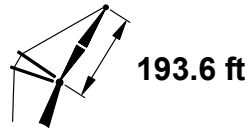
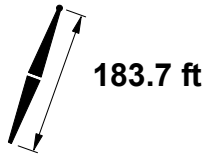

ft	75°				70°				65°				ft
	ft	ft	lb	lb	ft	ft	lb	lb	ft	ft	lb	lb	
80													80
85													85
90													90
95													95
100													100
105													105
110													110
115													115
120													120
125													125
130													130
135													135
140													140
145	63.9	359.2	168,200	280,200									145
150	62.2	356.6	160,400	268,700									150
155	60.5	353.7	153,000	258,000									155
160	58.8	350.6	146,100	248,100									160
165	57.0	347.3	139,600	238,700									165
170	55.2	343.7	133,500	229,900									170
175	53.3	340.0	127,800	221,600	58.8	345.6	111,900	209,700					175
180	51.4	335.9	122,300	213,900	57.1	342.3	107,000	202,300					180
185	49.5	331.6	117,200	206,500	55.3	338.8	102,300	195,300					185
190	47.4	327.0	112,300	199,600	53.4	335.1	97,800	188,700					190
195	45.3	322.0	107,700	193,000	51.5	331.0	93,600	182,400					195
200	43.2	316.6	103,300	186,700	49.6	326.7	89,600	176,400					200
205	40.9	310.8	99,100	180,800	47.5	322.1	85,800	170,700	53.3	328.5	72,800	161,000	205
210	38.5	304.5	95,100	175,100	45.5	317.1	82,100	165,400	51.4	324.4	69,500	155,900	210
215	36.0	297.6	91,300	169,800	43.3	311.8	78,700	160,200	49.5	320.1	66,300	151,000	215
220	33.3	290.0	87,600	164,600	41.0	306.0	75,300	155,300	47.4	315.4	63,300	146,300	220
230	27.2	271.9	80,600	155,000	36.1	292.8	69,000	146,200	43.2	305.1	57,600	137,600	230
240	19.3	247.0	74,100	146,100	30.5	276.9	63,200	137,800	38.5	293.0	52,400	129,600	240
250					23.8	256.2	57,700	130,000	33.3	278.5	47,500	122,200	250
260					13.9	224.5	52,400	122,700	27.2	260.4	42,900	115,400	260
270									19.2	235.5	38,500	109,000	270

# MLC650 VPC-MAX S-2

ASME B30.5



661,300 lb



360°

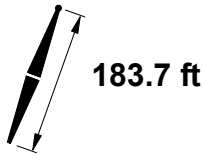

183.7 ft



213.3 ft

ft	85°				83°				80°				ft
	ft	lb	lb	lb	ft	lb	lb	lb	ft	lb	lb	lb	
85	74.6	398.0	282,700	282,700									85
90	73.2	396.4	282,700	282,700									90
95	71.8	394.7	282,500	282,500									95
100	70.4	392.9	281,900	281,900	72.2	394.4	280,200	280,200					100
105	68.9	390.9	281,200	281,200	70.8	392.7	280,200	280,200					105
110	67.5	388.8	280,200	280,200	69.4	390.7	280,200	280,200					110
115	66.0	386.6	278,600	279,100	67.9	388.6	268,000	280,200					115
120	64.5	384.1	263,800	277,800	66.4	386.4	253,600	280,200	69.2	388.9	238,500	272,900	120
125	63.0	381.5	250,200	276,400	64.9	384.0	240,400	280,200	67.8	386.8	226,000	272,900	125
130	61.5	378.8	237,600	271,200	63.4	381.5	228,300	279,800	66.3	384.6	214,400	272,900	130
135	59.9	375.8	226,100	262,400	61.9	378.8	217,100	279,100	64.8	382.2	203,800	272,900	135
140	58.3	372.7	215,300	253,500	60.3	375.9	206,700	278,200	63.3	379.6	193,900	272,900	140
145	56.7	369.4	205,400	244,500	58.8	372.8	197,100	277,200	61.8	376.9	184,700	272,900	145
150	55.1	365.8	196,100	235,700	57.2	369.5	188,100	271,200	60.2	374.0	176,200	272,900	150
155	53.4	362.1	187,400	226,900	55.5	366.0	179,700	262,300	58.6	370.9	168,200	269,000	155
160	51.7	358.1	179,300	218,300	53.9	362.3	171,800	253,400	57.0	367.6	160,700	258,600	160
165	49.9	353.8	171,700	210,000	52.2	358.4	164,400	244,500	55.4	364.1	153,700	248,800	165
170	48.1	349.3	164,500	202,000	50.4	354.2	157,500	235,600	53.7	360.4	147,100	239,700	170
175	46.2	344.4	157,700	194,300	48.6	349.8	150,900	226,900	52.0	356.4	140,800	231,100	175
180	44.3	339.3	151,300	186,900	46.7	345.0	144,700	218,400	50.2	352.2	134,900	223,000	180
185	42.3	333.7	145,300	179,900	44.8	339.9	138,900	210,200	48.4	347.7	129,400	215,300	185
190	40.2	327.8	139,500	173,300	42.9	334.5	133,300	202,300	46.6	342.9	124,100	208,100	190
195	38.0	321.4	134,100	167,100	40.8	328.7	128,100	194,700	44.6	337.8	119,100	201,200	195
200	35.7	314.4	128,900	161,300	38.6	322.4	123,100	187,600	42.7	332.4	114,300	194,700	200
205	33.3	306.8	123,900	156,000	36.4	315.6	118,300	180,800	40.6	326.5	109,800	188,600	205
210	30.6	298.4	119,200	151,200	34.0	308.2	113,700	174,500	38.4	320.2	105,500	182,700	210
215	27.8	289.0	114,700	146,900	31.4	300.0	109,300	168,600	36.1	313.3	101,300	177,100	215
220	24.6	278.3	110,300	143,300	28.6	290.9	105,100	163,400	33.7	305.8	97,400	171,700	220
230	16.5	249.8	102,000	136,500	22.0	268.6	97,200	154,700	28.3	288.4	89,900	161,700	230
240					12.2	233.5	89,600	129,300	21.7	265.7	82,900	152,500	240
250									11.5	229.4	76,200	132,200	250
260													260
270													270
280													280
290													290

# MLC650 VPC-MAX S-2

ASME B30.5

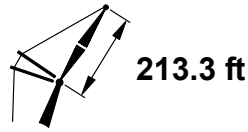
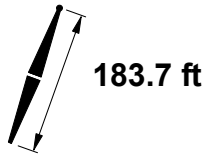

ft	75°				70°				65°				ft
	ft	°	ft	lb	ft	°	ft	lb	ft	°	ft	lb	
85													85
90													90
95													95
100													100
105													105
110													110
115													115
120													120
125													125
130													130
135													135
140													140
145													145
150	65.0	378.8	156,600	254,500									150
155	63.5	376.2	149,300	254,500									155
160	61.9	373.5	142,400	244,800									160
165	60.4	370.6	136,000	235,500									165
170	58.8	367.5	129,900	226,800									170
175	57.2	364.3	124,200	218,600									175
180	55.6	360.8	118,800	210,900									180
185	53.9	357.1	113,700	203,600	58.9	362.6	98,400	192,100					185
190	52.2	353.2	108,900	196,600	57.3	359.3	94,000	185,500					190
195	50.5	349.0	104,300	190,100	55.7	355.9	89,800	179,200					195
200	48.7	344.6	100,000	183,900	54.0	352.2	85,900	173,300					200
205	46.8	339.8	95,800	178,000	52.3	348.3	82,100	167,700					205
210	44.9	334.8	91,900	172,400	50.5	344.1	78,500	162,400					210
215	42.9	329.3	88,100	167,100	48.7	339.7	75,100	157,300	53.9	345.6	62,400	147,800	215
220	40.9	323.5	84,500	162,000	46.9	335.0	71,800	152,400	52.2	341.7	59,400	143,200	220
230	36.4	310.5	77,700	152,400	43.0	324.5	65,600	143,400	48.7	333.0	53,900	134,500	230
240	31.5	294.9	71,400	143,700	38.8	312.5	59,900	135,000	44.9	323.2	48,700	126,600	240
250	25.6	275.6	65,500	135,600	34.2	298.4	54,700	127,400	40.9	312.0	44,000	119,300	250
260	18.0	249.0	60,000	128,100	28.8	281.2	49,700	120,300	36.4	299.0	39,600	112,600	260
270					22.3	259.2	45,100	113,700	31.5	283.4	35,400	106,400	270
280					12.8	225.1	40,400	107,400	25.6	264.1	31,500	100,500	280
290									18.0	237.5	27,600	95,000	290

# MLC650 VPC-MAX S-2

ASME B30.5



661,300 lb

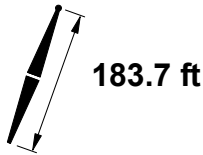

183.7 ft



232.9 ft

ft	85°				83°				80°				ft
	ft	lb	lb	lb	ft	lb	lb	lb	ft	lb	lb	lb	
90	74.7	417.0	241,600	241,600									90
95	73.4	415.5	241,400	241,400									95
100	72.1	413.8	241,100	241,100									100
105	70.8	412.1	240,500	240,500	72.5	413.5	238,400	238,400					105
110	69.5	410.2	239,900	239,900	71.2	411.8	238,400	238,400					110
115	68.2	408.1	239,100	239,100	69.9	409.9	238,400	238,400					115
120	66.8	405.9	238,200	238,200	68.5	407.9	238,400	238,400					120
125	65.5	403.6	237,100	237,100	67.2	405.8	238,200	238,200	69.7	408.1	223,500	230,600	125
130	64.1	401.1	235,700	236,000	65.8	403.5	226,200	237,800	68.4	406.1	212,000	230,600	130
135	62.7	398.5	224,100	234,800	64.5	401.0	215,000	237,300	67.1	404.0	201,400	230,600	135
140	61.3	395.7	213,400	233,500	63.1	398.5	204,600	236,700	65.7	401.7	191,500	230,600	140
145	59.9	392.8	203,500	229,000	61.7	395.7	195,000	236,000	64.3	399.2	182,400	230,600	145
150	58.4	389.7	194,200	222,000	60.3	392.8	186,000	235,300	63.0	396.6	173,900	230,600	150
155	57.0	386.4	185,500	214,900	58.8	389.8	177,600	234,500	61.6	393.9	165,900	230,600	155
160	55.5	382.9	177,400	207,800	57.4	386.5	169,800	233,600	60.1	390.9	158,400	230,600	160
165	53.9	379.2	169,800	200,800	55.9	383.1	162,400	230,900	58.7	387.9	151,400	230,600	165
170	52.4	375.3	162,700	193,900	54.4	379.4	155,500	223,900	57.2	384.6	144,900	230,600	170
175	50.8	371.2	155,900	187,100	52.8	375.6	149,000	216,800	55.7	381.1	138,700	229,000	175
180	49.1	366.8	149,600	180,500	51.2	371.5	142,800	209,700	54.2	377.5	132,800	221,000	180
185	47.5	362.2	143,500	174,200	49.6	367.2	137,000	202,700	52.7	373.6	127,300	213,400	185
190	45.7	357.3	137,800	167,900	47.9	362.7	131,500	195,800	51.1	369.5	122,000	206,200	190
195	44.0	352.0	132,400	162,000	46.2	357.9	126,300	189,000	49.4	365.2	117,100	199,300	195
200	42.1	346.5	127,300	156,400	44.5	352.7	121,300	182,400	47.8	360.6	112,300	192,900	200
205	40.2	340.5	122,400	151,000	42.6	347.3	116,500	176,100	46.1	355.8	107,800	186,700	205
210	38.2	334.2	117,700	145,900	40.8	341.4	112,000	169,900	44.3	350.6	103,500	180,900	210
215	36.1	327.3	113,200	141,100	38.8	335.2	107,700	164,100	42.5	345.1	99,500	175,300	215
220	33.9	319.9	109,000	136,700	36.7	328.5	103,600	158,500	40.6	339.3	95,500	170,000	220
230	29.1	302.8	100,900	128,900	32.3	313.3	95,800	148,400	36.5	326.2	88,200	160,100	230
240	23.3	281.5	93,500	122,900	27.1	295.0	88,700	139,800	32.0	310.9	81,400	151,000	240
250	15.4	251.1	86,400	116,300	20.8	271.2	82,000	132,100	26.8	292.4	75,100	142,600	250
260					11.2	233.6	75,400	110,100	20.4	268.3	69,200	134,800	260
270									10.5	229.2	63,400	112,800	270
280													280
290													290
300													300
310													310

# MLC650 VPC-MAX S-2

ASME B30.5

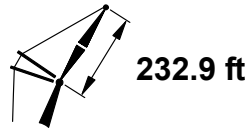
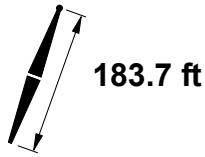

ft	75°				70°				65°				ft
	ft	°	ft	lb	ft	°	ft	lb	ft	°	ft	lb	
90													90
95													95
100													100
105													105
110													110
115													115
120													120
125													125
130													130
135													135
140													140
145													145
150													150
155													155
160	64.5	395.8	139,800	214,600									160
165	63.1	393.2	133,400	214,600									165
170	61.7	390.5	127,300	214,600									170
175	60.3	387.6	121,700	214,600									175
180	58.9	384.5	116,300	208,600									180
185	57.4	381.3	111,300	201,400									185
190	55.9	377.8	106,500	194,500									190
195	54.4	374.2	101,900	188,000	58.9	379.6	87,100	176,900					195
200	52.9	370.4	97,600	181,800	57.5	376.3	83,200	171,100					200
205	51.3	366.3	93,500	176,000	56.0	372.9	79,500	165,500					205
210	49.6	362.0	89,600	170,400	54.5	369.3	75,900	160,200					210
215	48.0	357.5	85,800	165,100	52.9	365.5	72,500	155,100					215
220	46.3	352.7	82,300	160,000	51.3	361.4	69,300	150,300					220
230	42.7	342.1	75,600	150,600	48.1	352.6	63,200	141,300	52.9	358.9	51,100	132,300	230
240	38.8	330.0	69,400	141,900	44.6	342.7	57,600	133,100	49.6	350.5	46,100	124,400	240
250	34.6	316.1	63,700	134,000	40.9	331.5	52,400	125,500	46.3	341.2	41,400	117,200	250
260	29.9	299.6	58,400	126,600	36.9	318.6	47,600	118,500	42.7	330.6	37,100	110,600	260
270	24.3	279.0	53,400	119,700	32.4	303.5	43,100	112,000	38.8	318.5	33,100	104,400	270
280	16.9	250.7	48,600	113,300	27.3	285.3	38,900	105,900	34.6	304.6	29,300	98,700	280
290					21.1	261.9	34,900	100,200	29.9	288.0	25,700	93,300	290
300					11.8	225.4	30,800	94,800	24.2	267.5	22,300	88,300	300
310									16.9	239.2		83,500	310

# MLC650 VPC-MAX S-2

ASME B30.5



661,300 lb

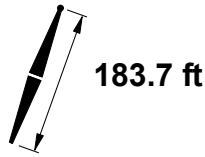

183.7 ft

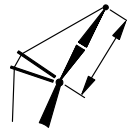

252.6 ft

ft	85°				83°				80°				ft
	ft	lb	lb	lb	ft	lb	lb	lb	ft	lb	lb	lb	
95	74.7	436.1	207,100	207,100									95
100	73.6	434.6	206,800	206,800									100
105	72.4	432.9	206,400	206,400									105
110	71.2	431.2	205,800	205,800	72.7	432.6	204,000	204,000					110
115	70.0	429.3	205,100	205,100	71.5	430.9	203,900	203,900					115
120	68.7	427.3	204,300	204,300	70.3	429.1	203,700	203,700					120
125	67.5	425.2	203,500	203,500	69.1	427.1	203,500	203,500					125
130	66.3	423.0	202,600	202,600	67.9	425.0	203,200	203,200					130
135	65.0	420.6	201,700	201,700	66.6	422.8	202,700	202,700	69.0	425.3	197,200	197,200	135
140	63.7	418.1	200,600	200,600	65.4	420.5	201,100	202,200	67.7	423.2	187,700	197,200	140
145	62.5	415.5	199,600	199,600	64.1	418.0	191,500	201,700	66.5	421.0	178,600	197,200	145
150	61.2	412.7	190,900	198,400	62.8	415.4	182,600	201,000	65.2	418.7	170,100	197,200	150
155	59.8	409.7	182,300	197,300	61.5	412.7	174,200	200,300	64.0	416.2	162,200	197,200	155
160	58.5	406.6	174,200	193,400	60.2	409.8	166,400	199,600	62.7	413.6	154,800	197,200	160
165	57.2	403.4	166,600	187,800	58.9	406.7	159,000	198,800	61.4	410.8	147,800	197,200	165
170	55.8	399.9	159,500	182,100	57.5	403.5	152,100	198,000	60.1	407.9	141,200	197,200	170
175	54.4	396.3	152,700	176,500	56.2	400.1	145,600	197,100	58.8	404.8	135,100	197,200	175
180	53.0	392.5	146,400	171,000	54.8	396.5	139,500	196,300	57.4	401.6	129,300	197,200	180
185	51.5	388.5	140,400	165,500	53.4	392.8	133,700	190,700	56.0	398.2	123,700	197,200	185
190	50.0	384.2	134,700	160,100	51.9	388.8	128,200	185,000	54.6	394.6	118,500	196,900	190
195	48.5	379.8	129,300	154,800	50.4	384.6	123,000	179,400	53.2	390.8	113,600	196,400	195
200	46.9	375.0	124,200	149,700	48.9	380.2	118,100	173,900	51.8	386.8	108,900	190,000	200
205	45.3	370.1	119,300	144,800	47.4	375.6	113,400	168,300	50.3	382.6	104,400	183,900	205
210	43.7	364.8	114,700	140,000	45.8	370.7	108,900	163,000	48.8	378.2	100,200	178,000	210
215	42.0	359.2	110,300	135,500	44.2	365.5	104,600	157,700	47.2	373.5	96,100	172,500	215
220	40.2	353.3	106,000	131,100	42.5	360.0	100,500	152,600	45.6	368.6	92,200	167,200	220
230	36.5	340.2	98,100	123,000	38.9	348.0	92,800	142,900	42.3	357.9	85,000	157,400	230
240	32.4	325.0	90,800	116,000	35.1	334.2	85,800	134,100	38.7	345.7	78,300	148,300	240
250	27.7	307.0	84,000	110,000	30.8	318.1	79,300	126,300	34.9	331.9	72,100	140,000	250
260	22.1	284.4	77,700	105,400	25.8	298.7	73,200	119,600	30.5	315.7	66,400	132,400	260
270	14.4	252.2	71,600	97,800	19.7	273.6	67,400	111,700	25.5	296.1	61,000	125,300	270
280					10.3	233.4	61,800	92,200	19.3	270.6	55,900	114,500	280
290									9.6	228.8	50,800	94,800	290
300													300
310													310
320													320
330													330

# MLC650 VPC-MAX S-2

ASME B30.5

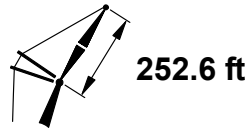
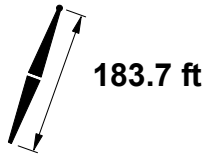

ft	75°				70°				65°				ft
	ft	°	ft	lb	ft	°	ft	lb	ft	°	ft	lb	
95													95
100													100
105													105
110													110
115													115
120													120
125													125
130													130
135													135
140													140
145													145
150													150
155													155
160													160
165													165
170	64.1	412.8	123,300	183,000									170
175	62.9	410.2	117,700	183,000									175
180	61.6	407.4	112,400	183,000									180
185	60.3	404.5	107,400	183,000									185
190	58.9	401.5	102,600	183,000									190
195	57.6	398.2	98,100	183,000									195
200	56.2	394.9	93,800	178,700									200
205	54.8	391.3	89,700	172,900	59.0	396.5	75,400	162,200					205
210	53.4	387.5	85,900	167,300	57.6	393.3	71,900	156,900					210
215	51.9	383.6	82,100	162,100	56.3	389.9	68,500	151,900					215
220	50.5	379.4	78,600	157,000	54.9	386.4	65,300	147,100					220
230	47.4	370.4	72,000	147,700	52.0	378.7	59,300	138,200					230
240	44.2	360.3	65,900	139,100	49.0	370.2	53,800	130,000	53.4	376.0	42,000	121,200	240
250	40.8	349.0	60,300	131,200	45.9	360.7	48,700	122,500	50.5	367.9	37,400	114,100	250
260	37.1	336.2	55,100	123,900	42.6	350.0	44,000	115,500	47.4	358.9	33,200	107,500	260
270	33.0	321.4	50,200	117,100	39.1	338.0	39,600	109,100	44.2	348.8	29,200	101,400	270
280	28.5	303.9	45,600	110,800	35.2	324.3	35,500	103,100	40.8	337.5	25,500	95,700	280
290	23.0	282.2	41,300	104,900	30.9	308.4	31,600	97,600	37.1	324.7	22,100	90,400	290
300	15.9	252.2	37,100	99,400	26.0	289.1	27,900	92,300	33.0	309.9		85,500	300
310					20.0	264.4	24,400	87,400	28.5	292.4		80,800	310
320					10.8	225.4	20,800	82,700	23.0	270.7		76,400	320
330									15.9	240.7		72,200	330

# MLC650 VPC-MAX S-2

ASME B30.5

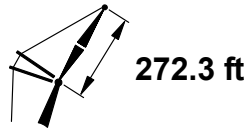
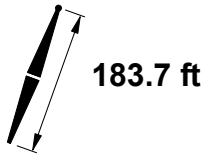

ft	85°				83°				80°				ft
	ft	lb	lb	lb	ft	lb	lb	lb	ft	lb	lb	lb	
100	74.8	455.1	177,000	177,000									100
105	73.7	453.6	176,600	176,600									105
110	72.6	452.0	176,200	176,200									110
115	71.5	450.3	175,600	175,600	72.9	451.7	174,300	174,300					115
120	70.4	448.5	175,000	175,000	71.8	450.0	174,100	174,100					120
125	69.2	446.5	174,300	174,300	70.7	448.2	173,900	173,900					125
130	68.1	444.5	173,600	173,600	69.5	446.3	173,600	173,600					130
135	66.9	442.3	172,800	172,800	68.4	444.3	173,200	173,200					135
140	65.8	440.0	171,900	171,900	67.3	442.2	172,800	172,800	69.4	444.5	168,500	168,500	140
145	64.6	437.6	171,000	171,000	66.1	439.9	172,300	172,300	68.3	442.5	168,500	168,500	145
150	63.4	435.1	170,200	170,200	64.9	437.5	171,700	171,700	67.2	440.4	167,600	168,500	150
155	62.2	432.4	169,200	169,200	63.8	435.0	171,100	171,100	66.0	438.1	159,700	168,500	155
160	61.0	429.6	168,300	168,300	62.6	432.4	164,200	170,500	64.8	435.7	152,300	168,500	160
165	59.8	426.7	164,600	167,300	61.4	429.6	156,900	169,800	63.7	433.2	145,400	168,500	165
170	58.6	423.6	157,500	166,300	60.2	426.7	150,000	169,100	62.5	430.5	138,900	168,400	170
175	57.3	420.3	150,800	164,700	58.9	423.7	143,500	168,400	61.3	427.8	132,700	168,200	175
180	56.1	416.9	144,400	160,200	57.7	420.5	137,400	167,700	60.0	424.8	126,900	167,900	180
185	54.8	413.4	138,500	155,800	56.4	417.1	131,600	166,900	58.8	421.8	121,500	167,700	185
190	53.4	409.6	132,800	151,400	55.1	413.6	126,200	166,200	57.6	418.6	116,300	167,300	190
195	52.1	405.7	127,500	146,900	53.8	409.9	121,000	165,400	56.3	415.2	111,400	167,000	195
200	50.7	401.6	122,400	142,600	52.5	406.0	116,100	163,700	55.0	411.7	106,700	166,600	200
205	49.4	397.2	117,500	138,300	51.1	402.0	111,400	159,300	53.7	407.9	102,300	166,200	205
210	47.9	392.7	112,900	134,200	49.7	397.7	106,900	154,800	52.4	404.0	98,000	165,800	210
215	46.5	387.9	108,500	130,100	48.3	393.2	102,700	150,500	51.0	400.0	94,000	165,400	215
220	45.0	382.9	104,300	126,200	46.9	388.5	98,600	146,100	49.6	395.7	90,100	164,900	220
230	41.9	372.0	96,400	118,600	43.9	378.3	91,000	137,600	46.7	386.4	82,900	155,600	230
240	38.5	359.7	89,200	111,600	40.7	366.9	84,000	129,500	43.7	376.2	76,300	146,600	240
250	35.0	345.9	82,500	105,400	37.3	354.1	77,600	122,000	40.5	364.7	70,200	138,400	250
260	31.0	329.9	76,300	99,800	33.6	339.6	71,600	115,100	37.1	351.9	64,600	130,800	260
270	26.5	310.9	70,600	95,100	29.4	322.7	66,100	109,000	33.4	337.2	59,300	123,700	270
280	21.0	287.1	65,100	91,700	24.6	302.2	60,800	103,800	29.2	320.2	54,400	117,200	280
290	13.6	253.1	59,800	82,900	18.7	275.8	55,900	95,400	24.4	299.5	49,700	110,700	290
300					9.4	232.9	50,900	77,300	18.4	272.7	45,300	98,000	300
310									8.7	228.0	40,800	80,300	310
320													320
330													330
340													340
350													350



# MLC650 VPC-MAX S-2

ASME B30.5

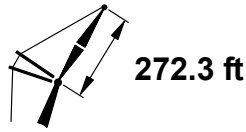
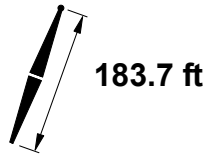
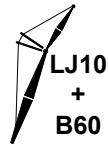

ft	75°				70°				65°				
	ft	°	ft	lb	ft	°	ft	lb	ft	°	ft	lb	
100													100
105													105
110													110
115													115
120													120
125													125
130													130
135													135
140													140
145													145
150													150
155													155
160													160
165													165
170													170
175	65.0	432.3	115,000	156,300									175
180	63.8	429.8	109,700	156,300									180
185	62.6	427.1	104,800	156,300									185
190	61.4	424.4	100,000	156,300									190
195	60.2	421.5	95,500	156,300									195
200	59.0	418.4	91,300	156,300									200
205	57.7	415.2	87,200	156,300									205
210	56.4	411.9	83,400	156,300									210
215	55.2	408.4	79,700	156,300	59.0	413.5	65,800	145,000					215
220	53.9	404.7	76,200	155,000	57.8	410.3	62,600	144,900					220
230	51.2	396.7	69,700	145,700	55.2	403.4	56,700	136,000					230
240	48.4	388.0	63,600	137,100	52.6	395.9	51,200	127,900					240
250	45.4	378.3	58,100	129,300	49.9	387.6	46,200	120,400	53.9	393.2	111,800		250
260	42.4	367.6	53,000	122,100	47.0	378.4	41,600	113,600	51.2	385.2	105,300		260
270	39.1	355.6	48,200	115,400	44.0	368.3	37,200	107,200	48.4	376.5	99,300		270
280	35.5	342.0	43,700	109,100	40.8	357.0	33,200	101,300	45.4	366.8	93,700		280
290	31.6	326.4	39,500	103,300	37.4	344.2	29,500	95,800	42.4	356.1	88,400		290
300	27.2	308.0	35,600	97,900	33.7	329.8	25,900	90,600	39.1	344.1	83,600		300
310	22.0	285.1	31,800	92,800	29.6	312.9	22,600	85,800	35.5	330.5	79,000		310
320	15.0	253.5	28,100	87,900	24.9	292.7		81,300	31.6	314.9	74,700		320
330					19.0	266.6		76,900	27.2	296.4	70,600		330
340					10.0	225.1		72,700	22.0	273.6	66,800		340
350									15.0	241.9	63,100		350

# MLC650 VPC-MAX S-2

ASME B30.5

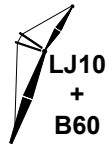

661,300 lb

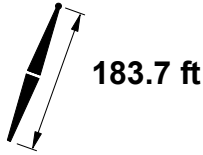

183.7 ft

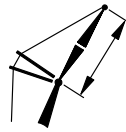

292.0 ft

ft	85°				83°				80°				ft
	ft	lb	lb	lb	ft	lb	lb	lb	ft	lb	lb	lb	
105	74.8	474.2	151,200	151,200									105
110	73.8	472.7	150,700	150,700									110
115	72.8	471.1	150,200	150,200									115
120	71.7	469.4	149,600	149,600									120
125	70.7	467.6	148,900	148,900	72.0	469.1	148,100	148,100					125
130	69.6	465.7	148,200	148,200	71.0	467.3	147,800	147,800					130
135	68.6	463.7	147,400	147,400	69.9	465.5	147,300	147,300					135
140	67.5	461.6	146,600	146,600	68.9	463.5	146,800	146,800					140
145	66.5	459.4	145,800	145,800	67.8	461.4	146,300	146,300	69.8	463.7	142,700	142,700	145
150	65.4	457.1	145,000	145,000	66.7	459.3	145,700	145,700	68.8	461.7	142,600	142,600	150
155	64.3	454.6	144,100	144,100	65.7	457.0	145,100	145,100	67.7	459.6	142,500	142,500	155
160	63.2	452.1	143,200	143,200	64.6	454.6	144,500	144,500	66.6	457.5	142,400	142,400	160
165	62.1	449.4	142,300	142,300	63.5	452.0	143,800	143,800	65.6	455.1	141,400	142,100	165
170	60.9	446.6	141,400	141,400	62.4	449.4	143,100	143,100	64.5	452.7	134,900	141,900	170
175	59.8	443.6	140,500	140,500	61.2	446.6	139,800	142,400	63.4	450.2	128,800	141,600	175
180	58.6	440.6	139,600	139,600	60.1	443.7	133,700	141,700	62.3	447.5	123,000	141,200	180
185	57.5	437.3	134,900	138,600	59.0	440.6	127,900	141,000	61.1	444.7	117,600	140,800	185
190	56.3	434.0	129,200	137,700	57.8	437.5	122,500	140,200	60.0	441.8	112,400	140,400	190
195	55.1	430.4	123,900	136,700	56.6	434.1	117,300	139,500	58.9	438.7	107,500	140,000	195
200	53.9	426.7	118,800	133,200	55.4	430.6	112,400	138,700	57.7	435.5	102,800	139,600	200
205	52.6	422.9	114,000	129,700	54.2	427.0	107,700	138,000	56.5	432.2	98,400	139,100	205
210	51.4	418.9	109,400	126,200	53.0	423.2	103,300	137,200	55.3	428.7	94,200	138,600	210
215	50.1	414.6	105,000	122,800	51.7	419.2	99,000	136,500	54.1	425.0	90,200	138,100	215
220	48.8	410.2	100,800	119,300	50.4	415.1	95,000	135,800	52.9	421.2	86,400	137,700	220
230	46.1	400.8	93,000	112,700	47.8	406.1	87,400	130,000	50.3	413.0	79,200	136,700	230
240	43.2	390.3	85,800	106,400	45.1	396.3	80,500	123,100	47.7	404.1	72,600	135,700	240
250	40.2	378.8	79,200	100,600	42.2	385.5	74,100	116,500	44.9	394.2	66,600	134,800	250
260	37.0	365.9	73,000	95,100	39.1	373.5	68,200	110,200	42.0	383.4	61,000	127,800	260
270	33.6	351.3	67,300	90,100	35.8	360.0	62,700	104,200	39.0	371.3	55,800	120,800	270
280	29.7	334.5	62,000	85,800	32.2	344.7	57,600	98,800	35.7	357.7	50,900	114,300	280
290	25.4	314.6	57,000	82,100	28.2	326.9	52,700	94,000	32.1	342.3	46,400	108,300	290
300	20.1	289.7	52,200	79,400	23.6	305.5	48,200	89,900	28.0	324.4	42,100	101,100	300
310	12.8	253.8	47,600	68,100	17.8	277.8	43,800	79,400	23.4	302.8	38,000	93,600	310
320					8.6	232.1	39,500	62,600	17.5	274.6	34,100	81,800	320
330									7.9	226.8	30,100	65,800	330
340													340
350													350
360													360
370													370

# MLC650 VPC-MAX S-2

ASME B30.5

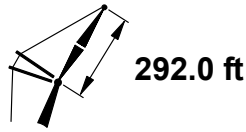
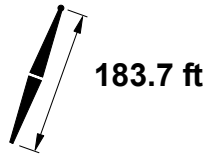

ft	75°				70°				65°			ft
	ft	lb	lb	lb	ft	lb	lb	lb	ft	lb		
105												105
110												110
115												115
120												120
125												125
130												130
135												135
140												140
145												145
150												150
155												155
160												160
165												165
170												170
175												175
180												180
185	64.6	449.3	100,500	131,700								185
190	63.5	446.8	95,800	131,700								190
195	62.4	444.1	91,400	131,700								195
200	61.3	441.3	87,100	131,700								200
205	60.1	438.4	83,100	131,700								205
210	59.0	435.4	79,300	131,700								210
215	57.8	432.2	75,600	131,700								215
220	56.7	428.9	72,200	131,700								220
230	54.3	421.8	65,600	131,700	57.9	427.3	52,400	121,200				230
240	51.8	414.0	59,700	131,700	55.5	420.5	47,000	121,200				240
250	49.2	405.5	54,200	126,200	53.1	413.1	42,000	117,100				250
260	46.5	396.2	49,100	119,000	50.6	404.9	37,400	110,300	54.2	410.3	101,900	260
270	43.7	385.9	44,300	112,300	47.9	396.1	33,200	104,000	51.8	402.5	95,900	270
280	40.7	374.5	39,900	106,100	45.2	386.3	29,200	98,100	49.2	394.0	90,400	280
290	37.6	361.8	35,800	100,400	42.3	375.5	25,500	92,700	46.5	384.6	85,200	290
300	34.1	347.5	32,000	95,000	39.2	363.6	22,000	87,600	43.7	374.4	80,300	300
310	30.4	331.1	28,300	90,000	36.0	350.2		82,800	40.7	363.0	75,800	310
320	26.1	311.8	24,800	85,200	32.4	334.9		78,300	37.5	350.3	71,600	320
330	21.0	287.8	21,500	80,700	28.4	317.3		74,100	34.1	336.0	67,600	330
340	14.2	254.5		76,400	23.8	296.1		70,100	30.4	319.6	63,800	340
350					18.1	268.7		66,200	26.1	300.3	60,200	350
360					9.2	224.5		62,500	21.0	276.3	56,800	360
370									14.2	243.0	53,500	370

# MLC650 VPC-MAX S-2

ASME B30.5



661,300 lb

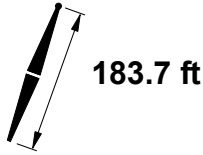

183.7 ft

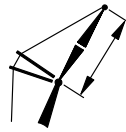

311.7 ft

ft	85°				83°				80°				ft
	ft	lb	lb	lb	ft	lb	lb	lb	ft	lb	lb	lb	
110	74.9	493.2	130,200	130,200									110
115	73.9	491.7	129,700	129,700									115
120	72.9	490.2	129,200	129,200									120
125	72.0	488.5	128,600	128,600									125
130	71.0	486.7	127,900	127,900	72.2	488.2	127,300	127,300					130
135	70.0	484.9	127,200	127,200	71.3	486.5	126,900	126,900					135
140	69.0	482.9	126,500	126,500	70.3	484.6	126,400	126,400					140
145	68.0	480.9	125,800	125,800	69.3	482.7	125,900	125,900					145
150	67.0	478.7	125,000	125,000	68.3	480.7	125,400	125,400					150
155	66.0	476.5	124,300	124,300	67.3	478.6	124,800	124,800	69.2	480.9	122,100	122,100	155
160	65.0	474.1	123,500	123,500	66.3	476.3	124,200	124,200	68.2	478.9	121,900	121,900	160
165	64.0	471.6	122,700	122,700	65.3	474.0	123,600	123,600	67.2	476.8	121,700	121,700	165
170	62.9	469.1	121,900	121,900	64.3	471.6	123,000	123,000	66.2	474.5	121,400	121,400	170
175	61.9	466.4	121,000	121,000	63.2	469.0	122,300	122,300	65.2	472.2	121,100	121,100	175
180	60.8	463.5	120,200	120,200	62.2	466.3	121,700	121,700	64.2	469.7	120,700	120,800	180
185	59.8	460.6	119,400	119,400	61.1	463.5	121,000	121,000	63.1	467.2	115,300	120,400	185
190	58.7	457.5	118,600	118,600	60.1	460.6	120,300	120,300	62.1	464.5	110,100	120,000	190
195	57.6	454.3	117,800	117,800	59.0	457.6	115,200	119,600	61.0	461.7	105,200	119,600	195
200	56.5	451.0	116,900	117,000	57.9	454.4	110,300	119,000	60.0	458.8	100,600	119,200	200
205	55.4	447.5	112,000	116,100	56.8	451.1	105,700	118,300	58.9	455.7	96,200	118,700	205
210	54.2	443.8	107,400	115,300	55.7	447.7	101,200	117,600	57.8	452.5	92,000	118,300	210
215	53.1	440.1	103,100	114,200	54.6	444.1	97,000	116,900	56.7	449.2	88,000	117,800	215
220	51.9	436.1	98,900	111,400	53.4	440.3	93,000	116,200	55.6	445.7	84,200	117,300	220
230	49.5	427.7	91,100	105,800	51.1	432.4	85,400	114,900	53.3	438.4	77,000	116,400	230
240	47.0	418.5	83,900	100,300	48.6	423.7	78,500	113,600	50.9	430.4	70,500	115,400	240
250	44.4	408.5	77,400	95,100	46.1	414.2	72,200	109,500	48.5	421.6	64,500	114,500	250
260	41.7	397.5	71,300	90,100	43.4	403.8	66,300	104,000	46.0	412.1	58,900	113,600	260
270	38.8	385.3	65,600	85,400	40.7	392.4	60,900	98,800	43.3	401.7	53,800	112,700	270
280	35.7	371.7	60,300	81,100	37.7	379.8	55,800	93,700	40.5	390.2	49,000	112,000	280
290	32.3	356.4	55,400	77,200	34.5	365.6	51,000	89,100	37.5	377.5	44,500	106,700	290
300	28.6	338.9	50,800	73,700	31.0	349.6	46,600	84,800	34.3	363.3	40,300	100,500	300
310	24.4	318.1	46,400	70,800	27.2	331.0	42,400	80,900	30.9	347.2	36,300	93,400	310
320	19.2	292.0	42,200	68,800	22.6	308.6	38,400	77,800	27.0	328.4	32,500	86,600	320
330	12.0	254.2	38,100	56,500	17.0	279.6	34,500	66,800	22.4	305.8	29,000	80,100	330
340					7.9	230.9	30,600	51,100	16.7	276.3	25,500	69,200	340
350									7.1	225.2	21,900	54,400	350
360													360
370													370
380													380
390													390

# MLC650 VPC-MAX S-2

ASME B30.5

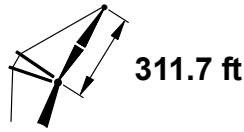
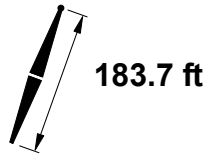
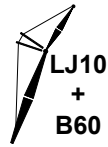

ft	75°				70°				65°				ft
	ft	ft	lb	lb	ft	ft	lb	lb	ft	ft	lb	lb	
110													110
115													115
120													120
125													125
130													130
135													135
140													140
145													145
150													150
155													155
160													160
165													165
170													170
175													175
180													180
185													185
190													190
195	64.3	466.3	88,800	112,300									195
200	63.3	463.7	84,600	112,300									200
205	62.2	461.1	80,600	112,300									205
210	61.2	458.3	76,800	112,300									210
215	60.1	455.4	73,200	112,300									215
220	59.0	452.3	69,700	112,300									220
230	56.8	445.9	63,200	112,300									230
240	54.6	438.9	57,300	112,300	58.0	444.2	44,400	102,800					240
250	52.3	431.2	51,800	112,300	55.8	437.5	39,500	102,800					250
260	49.9	422.9	46,800	112,300	53.5	430.2	34,900	102,800					260
270	47.4	413.8	42,100	110,500	51.2	422.3	30,700	102,000	54.6	427.3	93,800		270
280	44.8	403.9	37,700	104,300	48.7	413.6	26,800	96,200	52.3	419.7	88,300		280
290	42.1	393.1	33,700	98,600	46.2	404.2	23,100	90,700	49.9	411.4	83,100		290
300	39.2	381.1	29,900	93,300	43.6	393.8		85,700	47.4	402.3	78,300		300
310	36.2	367.8	26,300	88,300	40.8	382.4		81,000	44.8	392.4	73,800		310
320	32.9	352.8	22,900	83,600	37.8	369.9		76,500	42.1	381.6	69,600		320
330	29.2	335.6		79,200	34.6	355.8		72,300	39.2	369.6	65,700		330
340	25.1	315.4		75,000	31.2	339.9		68,400	36.2	356.3	61,900		340
350	20.1	290.4		71,000	27.3	321.4		64,600	32.9	341.3	58,400		350
360	13.4	255.4		67,200	22.8	299.2		61,100	29.2	324.1	55,100		360
370					17.3	270.5		57,700	25.1	303.9	51,900		370
380					8.4	223.6		54,300	20.1	278.8	48,800		380
390									13.4	243.8	45,800		390

# MLC650 VPC-MAX S-2

ASME B30.5



661,300 lb

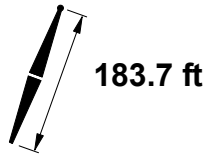

183.7 ft

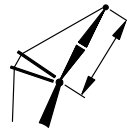

331.4 ft

ft	85°				83°				80°				ft
	ft	lb	lb	lb	ft	lb	lb	lb	ft	lb	lb	lb	
115	74.9	512.3	111,900	111,900									115
120	74.0	510.8	111,200	111,200									120
125	73.1	509.2	110,700	110,700									125
130	72.2	507.6	110,000	110,000									130
135	71.2	505.9	109,400	109,400	72.4	507.3	108,900	108,900					135
140	70.3	504.0	108,700	108,700	71.5	505.6	108,400	108,400					140
145	69.4	502.1	108,000	108,000	70.6	503.8	107,900	107,900					145
150	68.5	500.1	107,300	107,300	69.7	501.9	107,400	107,400					150
155	67.5	498.0	106,600	106,600	68.7	499.9	106,800	106,800					155
160	66.6	495.8	105,900	105,900	67.8	497.8	106,200	106,200	69.6	500.1	104,000	104,000	160
165	65.6	493.5	105,100	105,100	66.9	495.7	105,600	105,600	68.6	498.1	103,700	103,700	165
170	64.7	491.1	104,400	104,400	65.9	493.4	105,000	105,000	67.7	496.0	103,300	103,300	170
175	63.7	488.6	103,600	103,600	64.9	491.0	104,400	104,400	66.8	493.9	103,000	103,000	175
180	62.7	486.0	102,800	102,800	64.0	488.6	103,800	103,800	65.8	491.6	102,600	102,600	180
185	61.8	483.3	102,100	102,100	63.0	486.0	103,200	103,200	64.9	489.2	102,300	102,300	185
190	60.8	480.5	101,300	101,300	62.0	483.3	102,500	102,500	63.9	486.7	101,800	101,800	190
195	59.8	477.5	100,600	100,600	61.0	480.5	101,900	101,900	62.9	484.1	101,400	101,400	195
200	58.7	474.5	99,800	99,800	60.0	477.6	101,300	101,300	61.9	481.4	96,800	101,000	200
205	57.7	471.3	99,100	99,100	59.0	474.6	100,600	100,600	60.9	478.6	92,400	100,600	205
210	56.7	468.0	98,400	98,400	58.0	471.4	97,700	100,000	59.9	475.7	88,200	100,200	210
215	55.6	464.5	97,600	97,600	57.0	468.1	93,500	99,400	58.9	472.7	84,300	99,700	215
220	54.6	460.9	95,500	96,900	55.9	464.7	89,400	98,700	57.9	469.5	80,500	99,300	220
230	52.4	453.3	87,700	95,500	53.8	457.5	81,900	97,500	55.8	462.8	73,400	98,300	230
240	50.2	445.1	80,500	92,700	51.6	449.6	75,000	96,300	53.7	455.5	66,800	97,400	240
250	47.8	436.1	74,000	88,300	49.3	441.1	68,700	95,100	51.5	447.6	60,900	96,500	250
260	45.4	426.4	67,900	84,000	47.0	431.9	62,900	93,900	49.2	439.1	55,300	95,600	260
270	42.9	415.9	62,300	79,400	44.5	421.9	57,400	91,600	46.9	429.9	50,200	94,700	270
280	40.3	404.3	57,100	75,800	42.0	411.0	52,400	87,500	44.4	419.8	45,400	93,900	280
290	37.5	391.5	52,200	72,100	39.3	399.0	47,700	83,300	41.8	408.9	41,000	93,200	290
300	34.5	377.3	47,600	68,700	36.4	385.8	43,300	79,300	39.1	396.8	36,800	91,000	300
310	31.2	361.4	43,300	65,500	33.3	371.0	39,100	75,700	36.3	383.5	32,900	84,800	310
320	27.6	343.0	39,200	62,800	29.9	354.3	35,200	70,000	33.2	368.7	29,200	78,600	320
330	23.5	321.4	35,400	58,500	26.2	334.9	31,500	63,900	29.8	351.8	25,700	72,200	330
340	18.4	294.1	31,600	52,900	21.8	311.6	27,900	58,000	26.0	332.3	22,400	66,000	340
350	11.4	254.4	28,000	44,700	16.3	281.2	24,500	52,400	21.5	308.7		59,900	350
360					7.1	229.4	21,000	39,300	15.9	277.9		54,100	360
370									6.3	223.1		42,700	370
380													380
390													390
400													400
410													410

# MLC650 VPC-MAX S-2

ASME B30.5

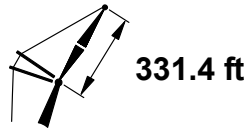
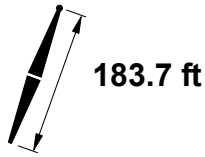

ft	75°				70°			65°			ft
	°	ft	lb	lb	°	ft	lb	°	ft	lb	
115											115
120											120
125											125
130											130
135											135
140											140
145											145
150											150
155											155
160											160
165											165
170											170
175											175
180											180
185											185
190											190
195											195
200	65.0	485.8	80,500	94,700							200
205	64.0	483.3	76,600	94,700							205
210	63.0	480.7	72,800	94,700							210
215	62.1	478.0	69,200	94,700							215
220	61.1	475.2	65,700	94,700							220
230	59.1	469.3	59,300	94,700							230
240	57.0	462.9	53,400	94,500							240
250	54.9	455.9	48,000	94,300	58.1	461.2	86,200				250
260	52.7	448.4	42,900	93,900	56.0	454.5	86,200				260
270	50.5	440.3	38,300	93,600	53.9	447.3	86,200				270
280	48.2	431.4	34,000	93,200	51.7	439.5	86,200	54.9	444.4	78,000	280
290	45.8	421.8	29,900	92,900	49.4	431.0	86,200	52.7	436.9	78,000	290
300	43.3	411.4	26,200	90,400	47.1	421.9	82,600	50.5	428.7	75,200	300
310	40.7	400.0	22,600	85,400	44.6	411.9	77,900	48.2	419.9	70,700	310
320	37.9	387.4		80,700	42.1	401.0	73,500	45.8	410.3	66,500	320
330	34.9	373.5		76,400	39.4	389.1	69,400	43.3	399.9	62,600	330
340	31.7	357.8		72,200	36.5	375.9	65,500	40.7	388.5	58,900	340
350	28.2	339.9		68,300	33.4	361.2	61,800	37.9	375.9	55,400	350
360	24.1	318.8		64,600	30.1	344.5	58,300	34.9	362.0	52,100	360
370	19.3	292.7		60,100	26.3	325.3	54,900	31.7	346.3	49,000	370
380	12.7	256.0		54,500	22.0	302.1	51,800	28.2	328.4	46,000	380
390					16.5	272.2	48,700	24.1	307.3	43,100	390
400					7.7	222.4	45,700	19.3	281.2	40,400	400
410								12.7	244.5	37,700	410

# MLC650 VPC-MAX S-2

ASME B30.5

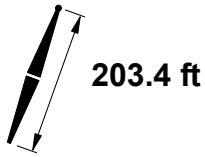

ft	85°				83°				80°				ft
	ft	lb	lb	lb	ft	lb	lb	lb	ft	lb	lb	lb	
55	73.1	293.5	631,800 c	728,600 c									55
60	69.5	291.5	570,500 c	716,200 c									60
65	65.8	289.1	519,300 c	692,200 c	71.0	291.5	500,500 c	734,700 c					65
70	61.9	286.3	476,000 b	668,100 b	67.3	289.3	458,700 c	714,900 c					70
75	57.9	283.1	438,700 b	644,800 b	63.6	286.7	422,800 b	684,500 b					75
80	53.7	279.3	406,400	622,500	59.6	283.6	391,600 b	642,600 b	67.7	287.8	369,400 b	625,000 b	80
85	49.3	274.9	377,900	587,200	55.5	280.1	364,200 b	597,800 b	64.0	285.2	343,500 b	581,400 b	85
90	44.4	269.7	352,800	553,300	51.1	275.9	340,000	558,600	60.1	282.2	320,600 b	543,300 b	90
95	39.1	263.4	330,300	523,400	46.5	271.1	318,300	523,900	56.0	278.7	300,200 b	509,500 b	95
100	32.9	255.7	309,900	483,300	41.4	265.3	298,900	493,000	51.6	274.7	281,900	479,500	100
105	25.3	245.5	291,400	405,300	35.6	258.3	281,200	465,300	47.0	269.9	265,300	452,600	105
110	13.3	228.4	273,900	317,600	28.7	249.3	265,000	440,300	41.9	264.2	250,200	428,300	110
115					19.3	236.3	249,900	367,700	36.2	257.4	236,400	406,200	115
120									29.5	248.7	223,500	386,100	120
125									20.6	236.3	211,400	367,600	125
130													130
135													135
140													140
145													145
150													150
155													155
160													160
165													165
170													170
175													175



# MLC650 VPC-MAX S-2

ASME B30.5

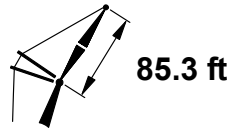
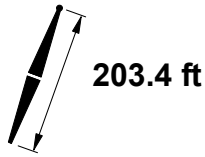
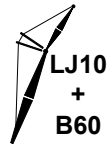

ft	75°				70°				65°				ft
	ft	°	ft	lb	ft	°	ft	lb	ft	°	ft	lb	
55													55
60													60
65													65
70													70
75													75
80													80
85													85
90													90
95													95
100													100
105													105
110	61.9	279.6	238,500 b	431,500 b									110
115	57.9	276.3	224,900 b	408,400 b									115
120	53.7	272.5	212,500 b	387,400 b									120
125	49.2	268.1	201,100	368,300									125
130	44.3	262.8	190,600	350,800	59.4	272.0	169,000	334,000					130
135	39.0	256.6	180,800	334,700	55.3	268.4	160,300	318,700					135
140	32.8	248.9	171,700	319,800	50.9	264.2	152,200	304,600					140
145	25.1	238.6	163,000	306,000	46.2	259.3	144,700	291,500					145
150	13.0	221.3	154,300	292,900	41.1	253.5	137,600	279,400					150
155					35.2	246.4	130,900	268,100	52.1	258.3	114,000	255,000	155
160					28.3	237.3	124,500	257,400	47.5	253.6	108,500	244,900	160
165					18.7	223.9	118,200	247,300	42.5	248.1	103,200	235,500	165
170									36.9	241.4	98,300	226,700	170
175									30.3	232.9	93,500	218,300	175
									21.7	221.1	88,700	210,300	175

# MLC650 VPC-MAX S-2

ASME B30.5

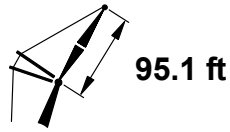
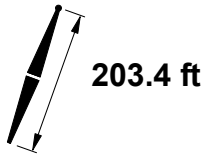

ft	85°				83°				80°				ft
	ft	lb	lb	lb	ft	lb	lb	lb	ft	lb	lb	lb	
55	74.9	303.8	629,200 c	669,100 c									55
60	71.7	302.1	568,000 c	666,700 c									60
65	68.5	300.0	516,900 c	661,200 c									65
70	65.1	297.6	473,600 b	645,200 b	69.8	300.1	455,900 b	673,000 b					70
75	61.7	294.8	436,500 b	623,600 b	66.5	297.8	420,100 b	667,500 b					75
80	58.1	291.6	404,200	600,100	63.1	295.1	389,000 b	639,500 b					80
85	54.4	287.9	375,900	565,900	59.6	292.1	361,800 b	594,900 b	66.9	296.3	340,600 b	578,200 b	85
90	50.4	283.6	350,900	533,300	55.9	288.6	337,700	555,900	63.5	293.7	317,800 b	540,200 b	90
95	46.2	278.8	328,600	503,100	52.1	284.6	316,200	521,300	60.0	290.7	297,500 b	506,700 b	95
100	41.7	273.1	308,500	475,800	48.0	280.0	296,900	490,600	56.3	287.3	279,300	476,800	100
105	36.6	266.3	290,300	452,100	43.6	274.7	279,400	463,100	52.5	283.3	262,900	450,000	105
110	30.8	258.0	273,700	431,500	38.8	268.4	263,500	438,200	48.4	278.8	247,900	425,900	110
115	23.5	247.0	258,400	363,900	33.3	260.8	249,000	415,700	44.1	273.5	234,300	404,000	115
120	11.8	228.3	243,700	287,100	26.7	251.1	235,500	395,100	39.3	267.4	221,800	384,000	120
125					17.8	237.1	222,700	332,900	33.9	259.9	210,100	365,800	125
130									27.5	250.6	199,300	348,900	130
135									19.0	237.2	189,000	333,300	135
140													140
145													145
150													150
155													155
160													160
165													165
170													170
175													175
180													180
185													185

# MLC650 VPC-MAX S-2

ASME B30.5

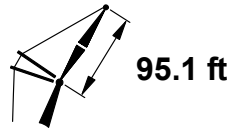
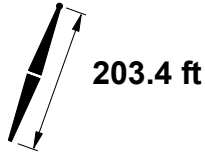

ft	75°				70°				65°				ft				
	ft	°	ft	lb	lb	ft	°	ft	lb	lb	ft	°		ft	lb	lb	
55																	55
60																	60
65																	65
70																	70
75																	75
80																	80
85																	85
90																	90
95																	95
100																	100
105																	105
110	61.6	288.0	221,800	405,500													110
115	58.0	284.8	209,500	384,700													115
120	54.3	281.1	198,300	365,700													120
125	50.4	276.8	187,900	348,300													125
130	46.1	271.9	178,300	332,300	59.4	280.4	157,000	315,900									130
135	41.6	266.2	169,400	317,600	55.7	276.9	149,100	301,900									135
140	36.5	259.4	161,000	304,000	51.9	272.9	141,700	289,000									140
145	30.6	251.1	153,200	291,300	47.8	268.3	134,800	276,900									145
150	23.3	240.0	145,600	279,400	43.4	262.9	128,300	265,700									150
155	11.5	221.0	138,000	268,000	38.5	256.5	122,200	255,300	52.9	267.0	105,300	242,300					155
160					33.0	248.9	116,300	245,400	48.9	262.5	100,200	233,000					160
165					26.3	239.0	110,700	236,200	44.6	257.3	95,400	224,300					165
170					17.1	224.6	105,100	227,300	39.8	251.3	90,800	216,100					170
175									34.5	244.0	86,400	208,300					175
180									28.3	234.9	82,100	200,900					180
185									20.1	222.2	77,900	193,800					185

# MLC650 VPC-MAX S-2

ASME B30.5

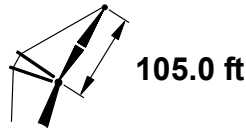
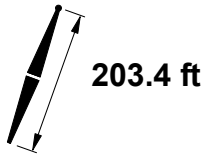

ft	85°				83°				80°				ft
	ft	lb	lb	lb	ft	lb	lb	lb	ft	lb	lb	lb	
60	73.5	312.5	566,600 c	614,400 c									60
65	70.6	310.7	515,600 b	611,900 b									65
70	67.6	308.5	472,400 b	606,400 b									70
75	64.6	306.1	435,300 b	599,100 b	71.8	310.6	454,400 b	618,700 b					75
80	61.5	303.3	403,100 b	576,000 b	68.9	308.6	418,700 b	618,600 b					80
					65.9	306.3	387,700 b	615,900 b					
85	58.2	300.1	374,900	545,400	62.8	303.6	360,500 b	592,900 b	69.2	307.1	338,900 b	576,000 b	85
90	54.9	296.4	350,000	515,400	59.6	300.6	336,500	554,000	66.2	304.8	316,200 b	538,200 b	90
95	51.4	292.4	327,800	486,700	56.3	297.1	315,100	519,600	63.1	302.2	296,000 b	504,800 b	95
100	47.6	287.7	307,900	459,800	52.8	293.3	295,900	489,000	59.9	299.2	277,900	475,000	100
105	43.6	282.4	289,800	435,100	49.2	288.8	278,600	461,600	56.6	295.8	261,600	448,400	105
110	39.3	276.2	273,500	413,200	45.3	283.8	262,800	436,900	53.2	292.0	246,800	424,300	110
115	34.5	268.9	258,500	394,200	41.2	278.0	248,400	414,500	49.6	287.6	233,200	402,600	115
120	28.9	260.0	244,700	379,200	36.6	271.3	235,200	394,100	45.8	282.7	220,800	382,700	120
125	22.0	248.3	231,800	331,900	31.4	263.1	223,000	375,400	41.6	277.0	209,400	364,600	125
130	10.5	227.9	219,300	261,700	25.1	252.8	211,600	358,200	37.1	270.3	198,800	347,900	130
135					16.4	237.7	200,700	304,100	32.0	262.3	188,900	332,500	135
140									25.8	252.3	179,600	318,200	140
145									17.6	238.0	170,700	304,900	145
150													150
155													155
160													160
165													165
170													170
175													175
180													180
185													185
190													190
195													195

# MLC650 VPC-MAX S-2

ASME B30.5

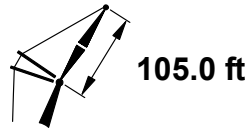
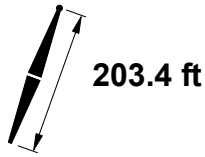
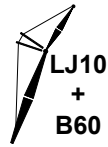

ft	75°				70°				65°				ft
	ft	ft	lb	lb	ft	ft	lb	lb	ft	ft	lb	lb	
60													60
65													65
70													70
75													75
80													80
85													85
90													90
95													95
100													100
105													105
110	64.6	299.3	220,100	403,700									110
115	61.4	296.5	207,900	382,900									115
120	58.2	293.3	196,700	364,000									120
125	54.8	289.7	186,500	346,700									125
130	51.3	285.6	177,000	330,900									130
135	47.6	280.9	168,200	316,200	59.4	288.9	147,300	300,300					135
140	43.6	275.6	160,000	302,700	56.1	285.5	140,000	287,400					140
145	39.2	269.4	152,300	290,100	52.6	281.6	133,200	275,400					145
150	34.4	262.1	145,100	278,400	49.0	277.1	126,800	264,300					150
155	28.8	253.1	138,200	267,500	45.1	272.1	120,800	253,900					155
160	21.8	241.3	131,600	257,100	40.9	266.2	115,200	244,200	53.6	275.6	98,500	231,500	160
165	10.2	220.6	124,800	247,200	36.3	259.4	109,800	235,100	50.0	271.3	93,800	222,800	165
170					31.1	251.1	104,600	226,500	46.2	266.4	89,300	214,700	170
175					24.7	240.6	99,700	218,300	42.1	260.8	85,100	207,000	175
180					15.8	225.1	94,700	210,500	37.6	254.3	81,000	199,800	180
185									32.5	246.4	77,100	192,900	185
190									26.6	236.7	73,300	186,300	190
195									18.6	223.1	69,500	180,000	195

# MLC650 VPC-MAX S-2

ASME B30.5

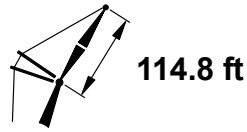
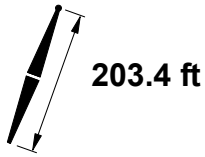

ft	85°				83°				80°				ft
	ft	lb	lb	lb	ft	lb	lb	lb	ft	lb	lb	lb	
60	75.0	322.9	565,100 b	565,100 b									60
65	72.4	321.2	544,500 b	564,700 b									65
70	69.7	319.3	498,900 b	561,900 b									70
75	67.0	317.1	459,800 b	556,800 b	70.8	319.3	442,900 b	569,200 b					75
80	64.2	314.6	425,900	550,000	68.1	317.2	410,100 b	568,800 b					80
85	61.3	311.7	396,200	524,900	65.3	314.8	381,400	566,100					85
90	58.4	308.6	369,900	498,200	62.5	312.1	356,100	551,100	68.4	315.7	335,400	535,100	90
95	55.3	305.0	346,600	471,900	59.6	309.1	333,500	516,900	65.6	313.3	314,100	501,800	95
100	52.1	301.0	325,600	446,600	56.6	305.7	313,300	486,400	62.8	310.6	294,900	472,200	100
105	48.8	296.6	306,700	422,700	53.4	301.9	295,100	459,100	59.9	307.7	277,700	445,600	105
110	45.2	291.5	289,500	400,500	50.2	297.6	278,500	434,500	56.9	304.3	262,000	421,700	110
115	41.4	285.8	273,900	380,300	46.7	292.8	263,400	412,200	53.8	300.6	247,800	400,000	115
120	37.3	279.2	259,500	362,400	43.0	287.4	249,600	391,900	50.5	296.3	234,700	380,300	120
125	32.7	271.4	246,300	347,200	39.1	281.2	236,900	373,300	47.1	291.6	222,700	362,300	125
130	27.3	261.9	233,900	335,300	34.7	273.9	225,100	356,300	43.4	286.3	211,600	345,700	130
135	20.6	249.4	222,300	299,200	29.7	265.3	214,100	340,500	39.5	280.2	201,300	330,400	135
140	9.3	227.3	211,000	237,200	23.7	254.3	203,800	325,900	35.2	273.0	191,700	316,300	140
145					15.2	238.2	193,800	276,800	30.3	264.6	182,700	303,100	145
150									24.4	253.9	174,200	290,800	150
155									16.4	238.6	165,900	279,300	155
160													160
165													165
170													170
175													175
180													180
185													185
190													190
195													195
200													200
205													205

# MLC650 VPC-MAX S-2

ASME B30.5

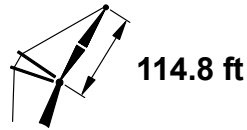
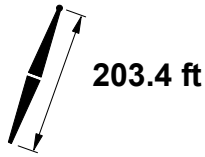
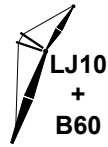

ft	75°				70°				65°				ft
	ft	°	ft	lb	ft	°	ft	lb	ft	°	ft	lb	
60													60
65													65
70													70
75													75
80													80
85													85
90													90
95													95
100													100
105													105
110													110
115	64.1	307.8	221,800	380,100									115
120	61.3	305.0	210,000	361,300									120
125	58.3	301.8	199,100	344,100									125
130	55.2	298.2	189,100	328,300									130
135	52.1	294.2	179,800	313,700									135
140	48.7	289.8	171,100	300,300	59.4	297.4	150,700	284,600					140
145	45.2	284.7	163,100	287,800	56.4	294.0	143,400	272,800					145
150	41.4	279.0	155,500	276,200	53.3	290.2	136,700	261,700					150
155	37.2	272.3	148,400	265,300	50.0	285.9	130,300	251,400					155
160	32.6	264.6	141,700	255,200	46.5	281.1	124,400	241,800					160
165	27.3	255.0	135,300	245,600	42.8	275.6	118,700	232,800	54.1	284.2	102,200	220,200	165
170	20.5	242.5	129,100	236,600	38.8	269.3	113,400	224,300	50.9	280.0	97,400	212,100	170
175	9.0	219.9	122,700	227,800	34.4	262.0	108,300	216,200	47.5	275.3	93,000	204,500	175
180					29.4	253.3	103,400	208,600	43.8	270.1	88,700	197,300	180
185					23.3	242.1	98,700	201,400	39.9	264.0	84,700	190,600	185
190					14.6	225.5	93,900	194,400	35.7	257.0	80,800	184,100	190
195									30.8	248.7	77,000	178,000	195
200									25.1	238.4	73,300	172,100	200
205									17.4	223.8	69,600	166,400	205

# MLC650 VPC-MAX S-2

ASME B30.5

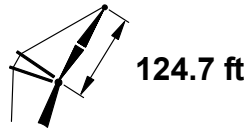
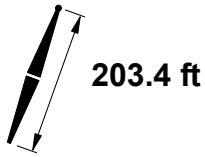
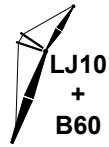

ft	85°				83°				80°				ft
	ft	lb	lb	lb	ft	lb	lb	lb	ft	lb	lb	lb	
65	73.8	331.6	522,900 b	522,900 b									65
70	71.4	329.9	499,100 b	522,000 b									70
75	68.9	327.8	460,000 b	519,000 b	72.4	329.8	443,000 b	524,700 b					75
80	66.4	325.6	426,200	514,500	69.9	327.9	410,300 b	524,700 b					80
85	63.8	323.0	396,500	504,800	67.4	325.7	381,600	524,700					85
90	61.2	320.2	370,300	481,300	64.9	323.3	356,300	523,400					90
95	58.4	317.0	347,000	457,700	62.3	320.6	333,800	516,300	67.7	324.2	314,200	501,100	95
100	55.6	313.5	326,100	434,600	59.6	317.5	313,600	485,900	65.1	321.8	295,100	471,600	100
105	52.7	309.7	307,200	412,200	56.8	314.2	295,500	458,700	62.5	319.1	277,900	445,100	105
110	49.7	305.3	290,100	390,900	53.9	310.5	279,000	434,200	59.9	316.1	262,300	421,300	110
115	46.5	300.5	274,600	371,000	51.0	306.3	264,000	411,900	57.1	312.8	248,100	399,700	115
120	43.1	295.1	260,300	352,600	47.8	301.7	250,200	391,700	54.3	309.1	235,100	380,000	120
125	39.5	289.0	247,200	336,000	44.5	296.6	237,600	373,200	51.3	305.0	223,100	362,100	125
130	35.5	282.0	235,100	321,400	41.0	290.8	225,900	356,200	48.2	300.5	212,100	345,500	130
135	31.1	273.8	223,800	309,000	37.2	284.2	215,100	340,600	44.9	295.4	201,900	330,300	135
140	26.0	263.7	213,200	299,400	33.0	276.5	205,000	326,100	41.4	289.7	192,400	316,300	140
145	19.5	250.5	203,200	276,200	28.2	267.3	195,500	312,600	37.6	283.2	183,500	303,200	145
150	8.2	226.5	193,300	218,200	22.4	255.7	186,500	300,000	33.5	275.6	175,200	291,100	150
155					14.2	238.5	177,900	255,600	28.8	266.6	167,400	279,700	155
160									23.1	255.3	159,900	269,000	160
165									15.3	239.1	152,700	259,000	165
170													170
175													175
180													180
185													185
190													190
195													195
200													200
205													205
210													210
215													215



# MLC650 VPC-MAX S-2

ASME B30.5

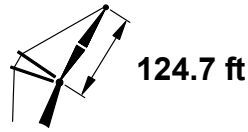
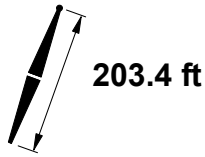
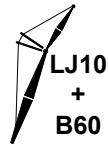

ft	75°				70°				65°				ft
	ft	lb	lb	lb	ft	lb	lb	lb	ft	lb	lb	lb	
65													65
70													70
75													75
80													80
85													85
90													90
95													95
100													100
105													105
110													110
115													115
120	63.8	316.3	210,000	360,900									120
125	61.1	313.4	199,200	343,700									125
130	58.4	310.3	189,200	328,000									130
135	55.6	306.8	180,000	313,500									135
140	52.7	302.9	171,400	300,100									140
145	49.6	298.5	163,400	287,700	59.4	305.9	143,500	272,500					145
150	46.4	293.7	156,000	276,100	56.7	302.5	136,800	261,500					150
155	43.1	288.3	149,000	265,400	53.8	298.8	130,500	251,300					155
160	39.4	282.2	142,400	255,300	50.8	294.6	124,600	241,700					160
165	35.5	275.1	136,100	245,800	47.7	290.0	119,100	232,700					165
170	31.0	266.9	130,200	236,900	44.4	284.8	113,800	224,300	54.6	292.7	97,600	212,000	170
175	25.9	256.8	124,500	228,500	40.8	279.0	108,800	216,300	51.6	288.7	93,200	204,400	175
180	19.3	243.5	119,000	220,500	37.0	272.3	104,100	208,800	48.5	284.2	89,000	197,300	180
185	7.8	219.0	113,300	212,700	32.8	264.5	99,600	201,700	45.3	279.2	85,000	190,600	185
190					27.9	255.3	95,200	195,000	41.8	273.5	81,200	184,200	190
195					22.0	243.5	90,900	188,500	38.1	267.1	77,500	178,200	195
200					13.6	225.7	86,600	182,300	34.0	259.7	74,000	172,400	200
205									29.3	250.9	70,700	166,900	205
210									23.8	239.9	67,300	161,600	210
215									16.3	224.5	64,000	156,500	215

# MLC650 VPC-MAX S-2

ASME B30.5

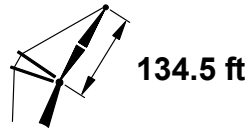
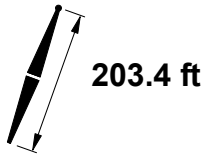

ft	85°				83°				80°				ft
	ft	lb	lb	lb	ft	lb	lb	lb	ft	lb	lb	lb	
70	72.8	340.3	482,100 b	482,100 b									70
75	70.5	338.5	457,500	481,000									75
80	68.2	336.4	423,700	478,400	71.5	338.4	407,500	484,100					80
85	65.9	334.1	394,100	474,000	69.2	336.4	378,900	484,100					85
90	63.5	331.5	367,900	462,700	66.9	334.2	353,700	484,100					90
95	61.0	328.7	344,600	442,100	64.5	331.8	331,200	482,600	69.4	334.9	311,200	479,500	95
100	58.5	325.5	323,800	421,400	62.1	329.0	311,100	479,600	67.1	332.7	292,200	468,800	100
105	55.9	322.1	305,000	400,900	59.6	326.0	293,000	456,200	64.7	330.3	275,000	442,400	105
110	53.3	318.3	288,000	381,100	57.0	322.7	276,500	431,700	62.3	327.6	259,500	418,700	110
115	50.5	314.1	272,400	362,200	54.4	319.0	261,600	409,600	59.8	324.6	245,400	397,200	115
120	47.6	309.4	258,200	344,300	51.6	315.0	247,900	389,400	57.3	321.3	232,400	377,600	120
125	44.5	304.3	245,200	327,700	48.8	310.5	235,300	371,000	54.7	317.7	220,500	359,700	125
130	41.3	298.5	233,100	312,400	45.8	305.6	223,700	354,100	51.9	313.7	209,600	343,200	130
135	37.8	292.0	222,000	298,600	42.6	300.1	213,000	338,500	49.1	309.3	199,400	328,100	135
140	34.0	284.6	211,600	286,500	39.3	294.0	203,000	324,100	46.1	304.4	190,000	314,100	140
145	29.7	275.9	201,900	276,400	35.6	287.0	193,600	310,700	43.0	299.0	181,200	301,100	145
150	24.7	265.4	192,700	268,600	31.5	278.9	184,900	298,200	39.6	292.9	173,000	289,000	150
155	18.4	251.4	184,000	249,900	26.9	269.2	176,600	286,600	36.0	286.0	165,300	277,700	155
160	7.1	225.3	175,100	198,100	21.3	256.9	168,800	271,700	32.0	278.1	158,000	267,200	160
165					13.2	238.7	161,100	232,600	27.4	268.6	151,200	257,200	165
170									21.9	256.7	144,600	247,900	170
175									14.3	239.5	138,100	239,000	175
180													180
185													185
190													190
195													195
200													200
205													205
210													210
215													215
220													220

# MLC650 VPC-MAX S-2

ASME B30.5

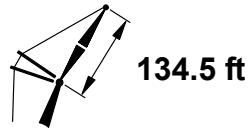
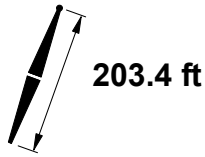

ft	75°				70°				65°				ft
	ft	°	ft	lb	ft	°	ft	lb	ft	°	ft	lb	
70													70
75													75
80													80
85													85
90													90
95													95
100													100
105													105
110													110
115													115
120													120
125	63.4	324.7	196,100	341,000									125
130	61.0	321.9	186,200	325,400									130
135	58.5	318.8	177,000	311,000									135
140	55.9	315.3	168,500	297,600									140
145	53.2	311.5	160,600	285,300									145
150	50.4	307.3	153,200	273,800	59.4	314.4	133,600	258,900					150
155	47.5	302.6	146,300	263,100	56.9	311.0	127,400	248,700					155
160	44.5	297.5	139,700	253,000	54.2	307.3	121,600	239,200					160
165	41.2	291.7	133,600	243,600	51.5	303.3	116,100	230,300					165
170	37.7	285.2	127,800	234,800	48.6	298.8	110,900	221,900					170
175	33.9	277.8	122,300	226,500	45.6	293.9	106,000	214,000	54.9	301.3	89,900	201,800	175
180	29.6	269.1	117,000	218,600	42.5	288.3	101,300	206,500	52.2	297.3	85,800	194,800	180
185	24.6	258.5	112,000	211,100	39.1	282.1	96,900	199,500	49.4	293.0	81,900	188,100	185
190	18.3	244.4	107,000	204,000	35.4	275.1	92,700	192,800	46.5	288.2	78,100	181,800	190
195	6.7	217.7	101,800	197,000	31.3	266.9	88,600	186,500	43.3	282.8	74,600	175,800	195
200					26.6	257.1	84,700	180,400	40.0	276.8	71,200	170,100	200
205					20.9	244.7	80,900	174,600	36.4	270.0	67,900	164,700	205
210					12.6	225.9	76,900	169,000	32.4	262.1	64,800	159,500	210
215									28.0	252.9	61,700	154,500	215
220									22.6	241.3	58,700	149,700	220

# MLC650 VPC-MAX S-2

ASME B30.5



661,300 lb

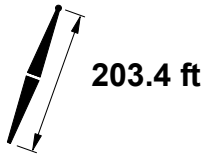

203.4 ft

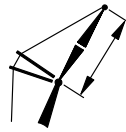

144.4 ft

ft	85°				83°				80°				ft
	ft	lb	lb	lb	ft	lb	lb	lb	ft	lb	lb	lb	
70	74.0	350.7	445,900 b	445,900 b									70
75	71.9	349.0	445,800	445,800									75
80	69.8	347.1	444,600	444,600	72.8	348.9	430,800	445,700					80
85	67.6	344.9	416,000	442,200	70.7	347.0	400,600	445,700					85
90	65.4	342.6	388,400	438,400	68.5	345.0	374,000	445,700					90
95	63.2	340.0	364,000	425,100	66.4	342.7	350,400	445,700					95
100	60.9	337.1	342,000	406,900	64.1	340.2	329,200	445,700	68.8	343.5	310,000	443,000	100
105	58.6	334.0	322,300	388,600	61.9	337.5	310,100	443,700	66.6	341.2	291,900	440,300	105
110	56.2	330.6	304,400	370,500	59.6	334.5	292,800	428,800	64.4	338.8	275,500	416,700	110
115	53.7	326.9	288,100	352,900	57.2	331.2	277,000	407,800	62.1	336.1	260,600	395,200	115
120	51.1	322.8	273,200	336,100	54.7	327.6	262,600	387,700	59.8	333.1	247,000	375,700	120
125	48.5	318.3	259,500	320,000	52.2	323.6	249,400	369,300	57.4	329.8	234,400	357,800	125
130	45.7	313.3	246,900	304,900	49.6	319.3	237,200	352,400	55.0	326.2	222,900	341,500	130
135	42.7	307.8	235,200	291,000	46.9	314.6	226,000	336,900	52.5	322.3	212,200	326,400	135
140	39.6	301.8	224,300	278,200	44.0	309.3	215,500	322,500	49.9	318.1	202,300	312,400	140
145	36.3	294.9	214,200	266,800	40.9	303.5	205,800	309,200	47.2	313.3	193,100	299,500	145
150	32.6	287.1	204,700	256,700	37.7	297.0	196,600	296,700	44.3	308.2	184,500	287,400	150
155	28.5	278.0	195,800	248,300	34.1	289.6	188,100	284,600	41.3	302.4	176,400	276,200	155
160	23.6	266.9	187,400	242,100	30.2	281.1	180,000	274,000	38.0	296.0	168,800	265,700	160
165	17.5	252.2	179,300	230,300	25.7	271.0	172,400	264,200	34.5	288.7	161,700	255,900	165
170	6.0	223.8	171,100	180,800	20.3	258.1	165,100	246,000	30.7	280.4	154,900	246,600	170
175					12.4	238.8	157,900	215,100	26.3	270.4	148,400	237,900	175
180									20.9	257.9	142,200	229,600	180
185									13.5	239.8	136,100	221,700	185
190													190
195													195
200													200
205													205
210													210
215													215
220													220
230													230

# MLC650 VPC-MAX S-2

ASME B30.5

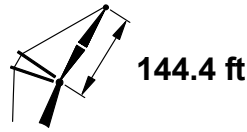
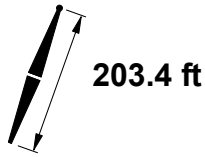

ft	75°				70°				65°				ft
	ft	ft	lb	lb	ft	ft	lb	lb	ft	ft	lb	lb	
70													70
75													75
80													80
85													85
90													90
95													95
100													100
105													105
110													110
115													115
120													120
125													125
130	63.2	333.2	199,200	323,500									130
135	60.9	330.4	189,500	309,100									135
140	58.5	327.2	180,500	295,800									140
145	56.1	323.8	172,100	283,500									145
150	53.7	320.1	164,300	272,100									150
155	51.1	316.0	156,900	261,400	59.4	322.8	137,800	246,900					155
160	48.4	311.5	150,100	251,400	57.1	319.5	131,600	237,400					160
165	45.6	306.5	143,600	242,000	54.6	315.9	125,800	228,500					165
170	42.7	301.0	137,500	233,300	52.1	311.9	120,300	220,200					170
175	39.6	294.9	131,700	225,000	49.4	307.6	115,100	212,300					175
180	36.2	288.1	126,300	217,200	46.7	302.8	110,200	204,900					180
185	32.5	280.3	121,100	209,800	43.8	297.5	105,500	197,900	52.8	306.0	90,200	186,400	185
190	28.4	271.1	116,100	202,800	40.8	291.7	101,100	191,300	50.2	301.7	86,200	180,100	190
195	23.5	260.0	111,300	196,100	37.5	285.1	96,800	185,000	47.4	297.1	82,500	174,100	195
200	17.3	245.2	106,500	189,700	33.9	277.7	92,800	179,000	44.6	291.9	78,900	168,500	200
205	5.5	215.9	101,500	183,400	30.0	269.1	88,900	173,400	41.6	286.2	75,400	163,100	205
210					25.5	258.9	85,100	167,900	38.4	279.9	72,100	158,000	210
215					19.9	245.8	81,400	162,700	34.9	272.7	69,000	153,100	215
220					11.8	225.9	77,600	157,500	31.1	264.5	65,900	148,400	220
230									21.6	242.6	60,000	139,600	230

# MLC650 VPC-MAX S-2

ASME B30.5

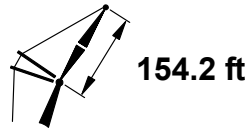
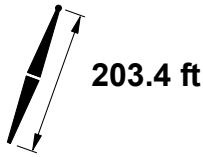
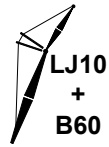

ft	85°				83°				80°				ft
	ft	lb	lb	lb	ft	lb	lb	lb	ft	lb	lb	lb	
75	73.1	359.4	413,000	413,000									75
80	71.1	357.6	412,600	412,600									80
85	69.2	355.7	411,400	411,400	72.0	357.5	397,900	413,600					85
90	67.1	353.5	386,000	408,800	70.0	355.6	371,400	413,600					90
95	65.1	351.1	361,600	405,400	68.0	353.5	347,700	413,600					95
100	63.0	348.5	339,700	391,600	65.9	351.2	326,600	413,600					100
105	60.8	345.6	319,900	375,400	63.8	348.7	307,500	412,900	68.2	352.0	289,100	409,700	105
110	58.6	342.5	302,100	359,200	61.7	346.0	290,300	410,900	66.1	349.8	272,700	409,700	110
115	56.4	339.1	285,800	343,100	59.6	343.0	274,600	396,900	64.1	347.3	257,800	392,700	115
120	54.1	335.4	270,900	327,500	57.3	339.7	260,200	380,900	62.0	344.5	244,200	373,200	120
125	51.7	331.4	257,300	312,400	55.1	336.1	247,000	364,800	59.8	341.6	231,700	355,400	125
130	49.2	327.0	244,700	298,100	52.7	332.3	234,900	348,900	57.6	338.3	220,200	339,100	130
135	46.7	322.3	233,100	284,500	50.3	328.0	223,700	333,400	55.3	334.8	209,600	324,100	135
140	44.0	317.0	222,300	271,700	47.8	323.4	213,200	318,400	53.0	330.9	199,700	310,200	140
145	41.2	311.3	212,200	260,000	45.1	318.4	203,500	304,100	50.5	326.8	190,600	297,300	145
150	38.1	304.9	202,800	249,200	42.3	312.9	194,500	290,700	48.0	322.2	182,000	285,300	150
155	34.9	297.7	194,000	239,600	39.4	306.7	186,000	278,200	45.4	317.2	174,000	274,100	155
160	31.3	289.5	185,700	231,300	36.3	299.9	178,000	266,800	42.6	311.7	166,500	263,600	160
165	27.3	280.0	177,900	224,400	32.8	292.2	170,500	256,500	39.7	305.7	159,400	253,900	165
170	22.6	268.4	170,400	219,400	29.0	283.3	163,400	247,700	36.6	298.9	152,700	244,600	170
175	16.6	253.0	163,300	208,700	24.7	272.6	156,600	240,500	33.2	291.3	146,400	236,000	175
180	4.8	221.6	155,800	163,800	19.3	259.2	150,100	223,000	29.5	282.5	140,400	227,800	180
185					11.6	238.8	143,700	196,500	25.2	272.1	134,600	220,000	185
190									20.0	259.1	129,000	212,700	190
195									12.7	240.0	123,600	205,600	195
200													200
205													205
210													210
215													215
220													220
230													230
240													240

# MLC650 VPC-MAX S-2

ASME B30.5

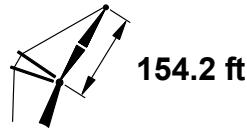
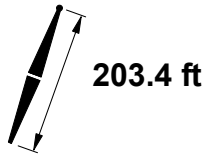

ft	75°				70°				65°				ft
	ft	°	ft	lb	ft	°	ft	lb	ft	°	ft	lb	
75													75
80													80
85													85
90													90
95													95
100													100
105													105
110													110
115													115
120													120
125													125
130													130
135	62.9	341.7	186,500	306,500									135
140	60.8	338.8	177,500	293,300									140
145	58.6	335.7	169,200	281,000									145
150	56.4	332.3	161,400	269,600									150
155	54.1	328.6	154,100	259,000									155
160	51.7	324.6	147,300	249,100	59.4	331.3	128,400	234,800					160
165	49.2	320.2	140,900	239,800	57.2	328.0	122,700	226,000					165
170	46.6	315.5	134,800	231,000	54.9	324.4	117,200	217,700					170
175	43.9	310.2	129,100	222,800	52.6	320.6	112,100	209,900					175
180	41.1	304.4	123,700	215,000	50.1	316.3	107,200	202,500					180
185	38.1	298.0	118,600	207,700	47.6	311.7	102,600	195,600					185
190	34.8	290.8	113,700	200,800	45.0	306.6	98,200	189,000	53.2	314.6	83,100	177,600	190
195	31.3	282.6	109,000	194,200	42.2	301.1	94,100	182,800	50.8	310.4	79,400	171,700	195
200	27.3	273.1	104,600	187,900	39.2	294.9	90,100	176,900	48.3	305.9	75,800	166,100	200
205	22.5	261.4	100,200	181,900	36.1	288.0	86,300	171,200	45.7	301.0	72,400	160,700	205
210	16.5	245.9	95,900	176,200	32.7	280.2	82,600	165,800	42.9	295.5	69,200	155,700	210
215	4.2	213.2	91,200	170,400	28.8	271.3	79,100	160,700	40.0	289.5	66,100	150,800	215
220					24.4	260.5	75,700	155,800	37.0	282.9	63,100	146,200	220
230					11.0	225.8	68,800	146,300	29.9	266.7	57,400	137,500	230
240									20.6	243.8	52,000	129,400	240

# MLC650 VPC-MAX S-2

ASME B30.5

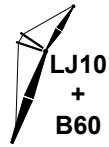

661,300 lb

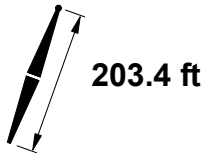

203.4 ft



164.0 ft

ft	85°				83°				80°				ft
	ft	lb	lb	lb	ft	lb	lb	lb	ft	lb	lb	lb	
75	74.2	369.7	381,400	381,400									75
80	72.3	368.1	381,400	381,400									80
85	70.5	366.2	380,900	380,900									85
90	68.6	364.2	379,200	379,200	71.2	366.2	370,600	381,400					90
95	66.7	362.0	361,000	376,800	69.4	364.2	347,000	381,400					95
100	64.7	359.6	339,100	374,000	67.5	362.1	325,900	381,400					100
105	62.8	356.9	319,400	362,200	65.5	359.8	306,900	381,400	69.6	362.7	288,200	374,400	105
110	60.7	354.1	301,600	347,900	63.6	357.2	289,700	380,700	67.7	360.6	271,900	374,400	110
115	58.7	351.0	285,300	333,500	61.6	354.4	274,000	378,900	65.7	358.3	257,100	374,400	115
120	56.6	347.6	270,500	319,300	59.6	351.4	259,600	368,700	63.8	355.8	243,500	372,200	120
125	54.4	344.0	256,900	305,300	57.5	348.2	246,500	354,600	61.8	353.0	231,000	354,500	125
130	52.2	340.0	244,300	291,800	55.3	344.7	234,400	340,200	59.8	350.0	219,600	338,200	130
135	49.9	335.8	232,700	278,800	53.1	340.9	223,200	326,000	57.7	346.8	209,000	323,200	135
140	47.5	331.1	221,900	266,400	50.9	336.7	212,800	312,100	55.6	343.3	199,100	309,300	140
145	45.1	326.1	211,900	254,700	48.5	332.3	203,100	298,500	53.4	339.5	190,000	296,500	145
150	42.5	320.6	202,600	243,800	46.1	327.4	194,100	285,600	51.1	335.4	181,400	284,500	150
155	39.7	314.5	193,800	233,800	43.5	322.1	185,700	273,200	48.8	331.0	173,500	273,400	155
160	36.8	307.8	185,600	224,600	40.9	316.2	177,700	261,600	46.4	326.2	166,000	263,000	160
165	33.6	300.3	177,900	216,400	38.0	309.8	170,300	250,800	43.8	320.9	158,900	253,200	165
170	30.2	291.8	170,500	209,200	35.0	302.7	163,300	241,000	41.2	315.2	152,300	244,100	170
175	26.3	281.8	163,600	203,400	31.7	294.6	156,600	232,200	38.3	308.8	146,100	235,400	175
180	21.7	269.7	157,000	199,200	28.0	285.3	150,300	224,500	35.3	301.7	140,100	227,300	180
185	15.8	253.6	150,500	191,500	23.7	274.2	144,200	218,300	32.0	293.8	134,500	219,600	185
190	3.2	217.9	143,700	148,100	18.5	260.1	138,400	204,500	28.4	284.6	129,100	212,300	190
195					10.8	238.7	132,600	180,300	24.2	273.8	123,900	205,400	195
200									19.1	260.1	118,900	198,800	200
205									11.9	240.0	113,900	189,500	205
210													210
215													215
220													220
230													230
240													240
250													250



# MLC650 VPC-MAX S-2

ASME B30.5

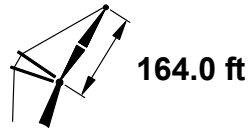
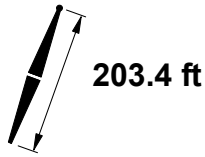
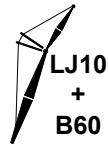

ft	75°				70°				65°				ft
	ft	°	ft	lb	ft	°	ft	lb	ft	°	ft	lb	
75													75
80													80
85													85
90													90
95													95
100													100
105													105
110													110
115													115
120													120
125													125
130													130
135	64.7	352.8	185,500	305,500									135
140	62.7	350.2	176,600	292,300									140
145	60.7	347.3	168,300	280,100									145
150	58.7	344.2	160,600	268,700									150
155	56.6	340.8	153,300	258,100									155
160	54.4	337.2	146,500	248,300									160
165	52.2	333.3	140,200	239,000	59.4	339.8	121,700	225,100					165
170	49.9	329.0	134,200	230,300	57.4	336.5	116,300	216,800					170
175	47.5	324.3	128,500	222,100	55.2	333.0	111,200	209,000					175
180	45.0	319.3	123,100	214,400	53.0	329.2	106,400	201,700					180
185	42.4	313.8	118,100	207,100	50.8	325.0	101,800	194,800					185
190	39.7	307.7	113,200	200,200	48.4	320.5	97,500	188,300					190
195	36.7	301.0	108,600	193,600	46.0	315.6	93,400	182,100	53.6	323.1	78,400	170,800	195
200	33.6	293.5	104,200	187,400	43.4	310.3	89,400	176,200	51.4	319.1	74,900	165,200	200
205	30.1	284.9	100,000	181,500	40.7	304.4	85,700	170,600	49.0	314.7	71,600	159,900	205
210	26.2	274.9	95,900	175,800	37.9	298.0	82,100	165,200	46.6	309.9	68,400	154,900	210
215	21.6	262.8	92,000	170,400	34.8	290.8	78,600	160,100	44.1	304.7	65,300	150,100	215
220	15.7	246.6	88,100	165,200	31.5	282.6	75,300	155,300	41.4	299.0	62,400	145,500	220
230					23.5	262.1	69,000	146,100	35.6	285.7	56,900	136,900	230
240					10.2	225.5	62,600	137,500	28.8	268.9	51,700	129,000	240
250									19.7	245.0	46,700	121,600	250

# MLC650 VPC-MAX S-2

ASME B30.5



661,300 lb

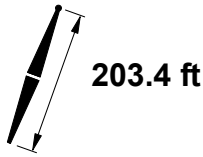

203.4 ft

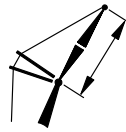

173.9 ft

ft	85°				83°				80°				ft
	ft	lb	lb	lb	ft	lb	lb	lb	ft	lb	lb	lb	
80	73.4	378.5	354,100	354,100									80
85	71.6	376.8	353,800	353,800									85
90	69.9	374.9	352,900	352,900	72.3	376.6	353,200	353,200					90
95	68.1	372.8	351,200	351,200	70.6	374.8	344,400	353,200					95
100	66.3	370.5	336,700	349,200	68.8	372.8	323,300	353,200					100
105	64.4	368.1	317,000	346,700	67.0	370.6	304,300	353,200					105
110	62.6	365.4	299,200	335,200	65.2	368.3	287,100	353,200	69.0	371.3	269,100	347,000	110
115	60.7	362.6	283,000	322,500	63.4	365.7	271,500	352,700	67.2	369.1	254,300	347,000	115
120	58.7	359.5	268,200	309,700	61.5	362.9	257,200	351,200	65.4	366.8	240,700	347,000	120
125	56.8	356.1	254,600	297,000	59.5	359.9	244,000	342,700	63.6	364.2	228,300	347,000	125
130	54.7	352.5	242,100	284,600	57.6	356.7	231,900	330,100	61.7	361.5	216,900	335,800	130
135	52.6	348.7	230,500	272,400	55.6	353.2	220,800	317,400	59.8	358.5	206,300	320,900	135
140	50.5	344.5	219,700	260,800	53.5	349.4	210,400	304,700	57.8	355.3	196,500	307,100	140
145	48.3	340.0	209,800	249,500	51.4	345.4	200,800	292,200	55.8	351.8	187,400	294,200	145
150	46.0	335.1	200,400	239,000	49.2	341.0	191,800	280,000	53.7	348.1	178,900	282,300	150
155	43.6	329.8	191,700	229,000	46.9	336.3	183,400	268,300	51.6	344.1	171,000	271,200	155
160	41.1	324.0	183,600	219,700	44.6	331.2	175,500	257,000	49.4	339.8	163,500	260,900	160
165	38.4	317.7	175,900	211,100	42.1	325.6	168,100	246,400	47.2	335.1	156,500	251,100	165
170	35.6	310.7	168,600	203,300	39.5	319.5	161,100	236,400	44.8	330.0	149,900	242,000	170
175	32.5	302.8	161,800	196,300	36.8	312.8	154,500	227,200	42.4	324.5	143,700	233,400	175
180	29.1	293.9	155,300	190,300	33.8	305.3	148,300	218,800	39.8	318.4	137,800	225,300	180
185	25.4	283.6	149,100	185,400	30.6	296.9	142,400	211,200	37.1	311.8	132,200	217,700	185
190	20.9	271.0	143,100	182,000	27.0	287.2	136,700	204,700	34.1	304.4	126,900	210,400	190
195	15.1	254.2	137,300	174,300	22.9	275.7	131,300	199,500	30.9	296.1	121,900	203,500	195
200					17.7	261.0	126,000	186,400	27.4	286.6	117,000	197,000	200
205					10.1	238.4	120,700	164,100	23.3	275.3	112,300	190,800	205
210									18.4	261.1	107,800	184,800	210
215									11.2	240.0	103,200	172,700	215
220													220
230													230
240													240
250													250
260													260

# MLC650 VPC-MAX S-2

ASME B30.5

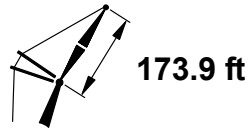
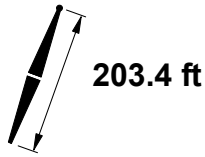

ft	75°				70°				65°				ft
	ft	lb	lb	lb	ft	lb	lb	lb	ft	lb	lb	lb	
80													80
85													85
90													90
95													95
100													100
105													105
110													110
115													115
120													120
125													125
130													130
135													135
140	64.4	361.3	173,600	289,800									140
145	62.5	358.7	165,300	277,600									145
150	60.6	355.8	157,600	266,300									150
155	58.7	352.7	150,400	255,800									155
160	56.7	349.3	143,700	245,900									160
165	54.7	345.7	137,400	236,700									165
170	52.6	341.9	131,400	228,000	59.4	348.3	113,200	214,300					170
175	50.5	337.7	125,800	219,800	57.5	345.0	108,200	206,600					175
180	48.2	333.2	120,500	212,200	55.5	341.5	103,400	199,300					180
185	45.9	328.3	115,400	204,900	53.4	337.8	98,800	192,400					185
190	43.5	323.0	110,600	198,000	51.3	333.7	94,600	185,900					190
195	41.0	317.2	106,100	191,500	49.1	329.3	90,500	179,700					195
200	38.4	310.8	101,700	185,300	46.8	324.5	86,600	173,900	54.0	331.7	71,800	162,800	200
205	35.5	303.8	97,600	179,500	44.5	319.4	82,900	168,300	51.9	327.7	68,500	157,500	205
210	32.5	296.0	93,600	173,900	42.0	313.8	79,300	163,000	49.7	323.4	65,300	152,500	210
215	29.1	287.1	89,800	168,500	39.4	307.7	76,000	158,000	47.4	318.8	62,300	147,700	215
220	25.3	276.7	86,100	163,400	36.6	300.9	72,700	153,200	45.1	313.7	59,400	143,200	220
230	15.0	247.1	78,900	153,700	30.4	284.9	66,500	144,100	40.1	302.3	54,000	134,600	230
240					22.6	263.5	60,700	135,800	34.5	288.4	49,000	126,800	240
250					9.5	225.1	54,900	127,900	27.8	270.9	44,200	119,600	250
260									19.0	246.0	39,600	112,800	260

# MLC650 VPC-MAX S-2

ASME B30.5



661,300 lb

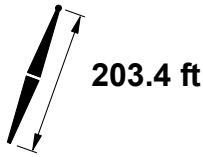

203.4 ft

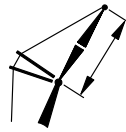

193.6 ft

ft	85°				83°				80°				ft
	ft	lb	lb	lb	ft	lb	lb	lb	ft	lb	lb	lb	
85	73.6	397.5	304,600	304,600									85
90	72.0	395.9	304,300	304,300									90
95	70.4	394.0	303,500	303,500	72.7	395.7	302,400	302,400					95
100	68.8	392.0	302,500	302,500	71.1	393.9	302,400	302,400					100
105	67.2	389.9	301,200	301,200	69.5	392.0	300,900	302,400					105
110	65.6	387.6	296,200	299,700	67.9	389.9	283,800	302,400					110
115	63.9	385.1	280,000	297,800	66.3	387.7	268,200	302,400	69.7	390.5	250,500	295,500	115
120	62.3	382.4	265,200	289,000	64.6	385.3	253,900	302,400	68.1	388.4	237,100	295,500	120
125	60.6	379.5	251,700	278,900	63.0	382.7	240,800	302,300	66.4	386.2	224,700	295,500	125
130	58.8	376.4	239,200	268,700	61.3	379.9	228,800	301,200	64.8	383.8	213,300	295,500	130
135	57.0	373.1	227,600	258,600	59.5	376.9	217,700	297,500	63.1	381.2	202,800	295,500	135
140	55.2	369.6	216,900	248,500	57.8	373.7	207,300	287,500	61.4	378.4	193,100	295,500	140
145	53.4	365.8	207,000	238,800	56.0	370.2	197,800	277,400	59.7	375.5	184,000	291,100	145
150	51.5	361.8	197,700	229,200	54.2	366.6	188,800	267,300	58.0	372.3	175,500	279,300	150
155	49.5	357.5	189,100	220,000	52.3	362.7	180,500	257,200	56.2	368.9	167,700	268,200	155
160	47.5	352.9	180,900	211,200	50.3	358.5	172,600	247,300	54.4	365.2	160,300	257,900	160
165	45.4	347.9	173,300	202,800	48.3	354.0	165,300	237,600	52.5	361.3	153,300	248,200	165
170	43.3	342.5	166,100	195,000	46.3	349.1	158,400	228,300	50.6	357.2	146,800	239,200	170
175	41.0	336.7	159,400	187,500	44.2	343.9	151,800	219,400	48.6	352.7	140,600	230,600	175
180	38.6	330.4	153,000	180,700	41.9	338.3	145,700	210,800	46.5	347.9	134,800	222,600	180
185	36.1	323.6	146,900	174,300	39.6	332.3	139,800	202,900	44.4	342.8	129,300	215,000	185
190	33.4	316.0	141,100	168,500	37.2	325.6	134,300	195,300	42.2	337.2	124,100	207,800	190
195	30.5	307.6	135,600	163,400	34.5	318.4	129,000	188,400	39.9	331.2	119,100	201,000	195
200	27.3	298.0	130,400	159,000	31.7	310.3	124,000	182,100	37.4	324.6	114,400	194,500	200
205	23.7	286.9	125,300	155,500	28.7	301.3	119,200	176,500	34.8	317.4	109,800	188,400	205
210	19.4	273.3	120,500	153,200	25.3	290.8	114,500	171,700	32.0	309.5	105,500	182,600	210
215	13.8	255.0	115,700	146,300	21.3	278.4	110,100	168,000	29.0	300.5	101,400	177,000	215
220					16.4	262.6	105,700	156,700	25.6	290.3	97,400	171,600	220
230									17.0	262.8	89,700	161,600	230
240													240
250													250
260													260
270													270
280													280

# MLC650 VPC-MAX S-2

ASME B30.5

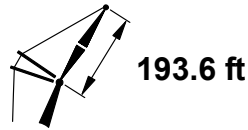
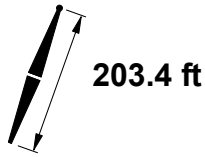

ft	75°				70°				65°				ft
	ft	°	ft	lb	ft	°	ft	lb	ft	°	ft	lb	
85													85
90													90
95													95
100													100
105													105
110													110
115													115
120													120
125													125
130													130
135													135
140													140
145													145
150	63.9	378.3	153,700	262,900									150
155	62.2	375.6	146,600	252,400									155
160	60.5	372.7	139,900	242,600									160
165	58.8	369.7	133,600	233,400									165
170	57.0	366.4	127,700	224,800									170
175	55.2	362.8	122,100	216,700									175
180	53.3	359.1	116,900	209,100	59.4	365.2	99,300	195,900					180
185	51.4	355.0	111,900	201,900	57.7	362.0	94,800	189,100					185
190	49.5	350.7	107,200	195,100	55.9	358.6	90,600	182,700					190
195	47.5	346.1	102,700	188,600	54.1	354.9	86,600	176,500					195
200	45.4	341.1	98,400	182,500	52.2	351.0	82,800	170,700					200
205	43.2	335.7	94,400	176,700	50.2	346.7	79,100	165,200					205
210	40.9	329.9	90,500	171,200	48.2	342.2	75,700	160,000	54.5	348.8	61,200	149,200	210
215	38.6	323.6	86,800	165,900	46.2	337.4	72,300	155,000	52.7	345.0	58,300	144,500	215
220	36.1	316.7	83,200	160,800	44.0	332.2	69,200	150,200	50.8	340.8	55,400	140,000	220
230	30.5	300.7	76,500	151,400	39.5	320.4	63,200	141,300	46.7	331.6	50,100	131,500	230
240	23.6	279.9	70,200	142,700	34.4	306.5	57,700	133,200	42.4	321.0	45,300	123,800	240
250	13.7	247.9	64,200	134,600	28.5	289.3	52,500	125,600	37.7	308.6	40,700	116,700	250
260					21.1	266.2	47,600	118,600	32.4	293.6	36,500	110,100	260
270					8.2	224.0	42,500	111,800	26.0	274.7	32,400	104,000	270
280									17.6	247.9	28,500	98,200	280

# MLC650 VPC-MAX S-2

ASME B30.5



661,300 lb



360°

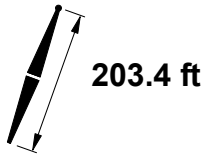

203.4 ft



213.3 ft

ft	85°				83°				80°				ft
	ft	lb	lb	lb	ft	lb	lb	lb	ft	lb	lb	lb	
90	73.7	416.6	261,200	261,200									90
95	72.3	415.0	261,000	261,000									95
100	70.9	413.2	260,500	260,500	72.9	414.8	259,200	259,200					100
105	69.4	411.3	259,800	259,800	71.5	413.1	259,200	259,200					105
110	68.0	409.2	258,800	258,800	70.0	411.2	259,200	259,200					110
115	66.5	407.0	257,700	257,700	68.6	409.2	259,200	259,200					115
120	65.0	404.6	257,200	257,200	67.1	407.0	250,600	259,200					120
125	63.5	402.1	248,700	255,900	65.7	404.7	237,600	259,200	68.8	407.7	221,100	254,200	125
130	62.0	399.3	236,200	250,100	64.2	402.3	225,600	259,200	67.3	405.5	209,700	254,200	130
135	60.5	396.5	224,700	242,100	62.6	399.6	214,500	258,400	65.8	403.2	199,300	254,200	135
140	58.9	393.4	214,000	234,100	61.1	396.8	204,200	257,600	64.3	400.8	189,600	254,200	140
145	57.3	390.1	204,100	226,100	59.5	393.8	194,600	256,600	62.8	398.2	180,500	254,200	145
150	55.6	386.7	194,900	218,100	57.9	390.7	185,700	251,100	61.3	395.4	172,100	254,200	150
155	54.0	383.0	186,200	210,200	56.3	387.3	177,400	243,100	59.7	392.4	164,300	254,200	155
160	52.3	379.1	178,100	202,500	54.7	383.7	169,600	235,100	58.1	389.3	156,900	254,200	160
165	50.5	374.9	170,500	195,100	53.0	379.9	162,300	227,100	56.5	385.9	150,000	245,300	165
170	48.7	370.5	163,400	187,800	51.2	375.8	155,400	219,100	54.8	382.3	143,500	236,300	170
175	46.9	365.7	156,700	180,800	49.5	371.5	148,900	211,300	53.2	378.5	137,400	227,800	175
180	45.0	360.7	150,300	174,200	47.6	366.9	142,800	203,700	51.4	374.5	131,600	219,800	180
185	43.0	355.3	144,300	167,800	45.8	362.0	137,000	196,300	49.7	370.2	126,200	212,200	185
190	40.9	349.5	138,600	161,800	43.8	356.7	131,500	189,100	47.8	365.6	121,000	205,100	190
195	38.8	343.2	133,200	156,200	41.8	351.1	126,300	182,300	46.0	360.8	116,100	198,300	195
200	36.5	336.5	128,000	151,000	39.7	345.0	121,300	175,800	44.0	355.5	111,400	191,900	200
205	34.1	329.1	123,100	146,200	37.5	338.5	116,600	169,700	42.0	350.0	106,900	185,800	205
210	31.6	321.0	118,400	141,800	35.1	331.4	112,100	163,900	39.9	343.9	102,700	180,000	210
215	28.8	311.9	113,900	137,900	32.6	323.6	107,800	158,600	37.7	337.5	98,600	174,500	215
220	25.7	301.7	109,500	134,600	30.0	315.0	103,600	153,800	35.4	330.4	94,700	169,200	220
230	18.1	275.3	101,300	130,400	23.8	294.1	95,800	145,900	30.3	314.2	87,400	159,300	230
240					15.2	263.9	88,300	132,300	24.1	293.7	80,600	150,300	240
250									15.8	264.2	74,100	138,200	250
260													260
270													270
280													280
290													290
300													300

# MLC650 VPC-MAX S-2

ASME B30.5

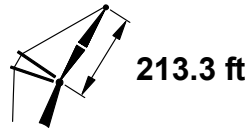
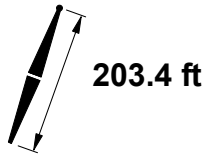

ft	75°				70°				65°				ft
	ft	°	ft	lb	ft	°	ft	lb	ft	°	ft	lb	
90													90
95													95
100													100
105													105
110													110
115													115
120													120
125													125
130													130
135													135
140													140
145													145
150													150
155													155
160	63.5	395.3	136,100	239,300									160
165	62.0	392.6	129,800	230,200									165
170	60.4	389.7	124,000	221,600									170
175	58.9	386.6	118,400	213,600									175
180	57.2	383.4	113,200	206,000									180
185	55.6	379.9	108,300	198,800									185
190	53.9	376.2	103,600	192,100	59.4	382.2	86,600	179,400					190
195	52.2	372.3	99,200	185,700	57.9	379.0	82,600	173,300					195
200	50.5	368.1	95,000	179,600	56.2	375.6	78,900	167,600					200
205	48.7	363.7	90,900	173,800	54.6	372.0	75,300	162,100					205
210	46.8	358.9	87,100	168,300	52.9	368.2	71,900	156,900					210
215	44.9	353.9	83,500	163,100	51.2	364.1	68,600	151,900					215
220	43.0	348.5	80,000	158,100	49.4	359.8	65,500	147,200					220
230	38.7	336.4	73,400	148,800	45.7	350.2	59,600	138,400	51.6	358.1	46,200	128,400	230
240	34.1	322.2	67,300	140,200	41.7	339.3	54,200	130,300	48.0	349.3	41,400	120,700	240
250	28.7	305.1	61,700	132,300	37.3	326.6	49,200	122,900	44.2	339.3	37,000	113,700	250
260	22.2	282.9	56,400	125,000	32.5	311.7	44,500	116,000	40.1	327.8	32,900	107,200	260
270	12.6	248.5	51,100	118,100	26.9	293.2	40,100	109,600	35.6	314.4	29,000	101,200	270
280					19.7	268.6	35,900	103,600	30.6	298.3	25,400	95,600	280
290					6.9	222.1	31,500	97,800	24.5	278.1	21,900	90,300	290
300									16.3	249.4		85,300	300

# MLC650 VPC-MAX S-2

ASME B30.5



661,300 lb

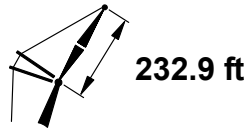
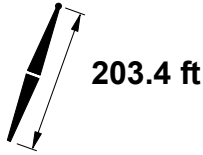

ft	85°				83°				80°				ft
	ft	lb	lb	lb	ft	lb	lb	lb	ft	lb	lb	lb	
95	73.9	435.7	224,700	224,700									95
100	72.6	434.0	224,400	224,400									100
105	71.3	432.3	224,000	224,000									105
110	70.0	430.4	223,500	223,500	71.8	432.2	222,600	222,600					110
115	68.6	428.4	222,700	222,700	70.5	430.4	222,600	222,600					115
120	67.3	426.3	221,900	221,900	69.2	428.4	222,600	222,600					120
125	65.9	424.0	221,000	221,000	67.8	426.3	222,600	222,600					125
130	64.6	421.6	219,900	219,900	66.5	424.1	222,300	222,300	69.3	426.9	207,200	216,300	130
135	63.2	419.0	218,700	218,700	65.1	421.8	212,300	221,900	68.0	424.8	196,800	216,300	135
140	61.8	416.3	212,000	217,500	63.8	419.3	202,000	221,400	66.6	422.6	187,100	216,300	140
145	60.4	413.4	202,100	211,900	62.4	416.6	192,500	220,800	65.3	420.3	178,100	216,300	145
150	58.9	410.4	192,900	205,500	61.0	413.8	183,600	220,100	63.9	417.8	169,700	216,300	150
155	57.5	407.1	184,300	199,000	59.5	410.8	175,300	219,300	62.5	415.1	161,900	216,300	155
160	56.0	403.7	176,200	192,600	58.1	407.6	167,500	218,400	61.1	412.3	154,600	216,300	160
165	54.5	400.1	168,700	186,200	56.6	404.3	160,300	214,400	59.7	409.4	147,700	216,300	165
170	52.9	396.3	161,600	179,900	55.1	400.7	153,400	208,000	58.2	406.2	141,200	216,300	170
175	51.3	392.2	154,900	173,800	53.6	397.0	146,900	201,600	56.8	402.9	135,200	216,300	175
180	49.7	387.9	148,500	167,800	52.0	393.1	140,800	195,200	55.3	399.4	129,400	216,300	180
185	48.0	383.4	142,500	161,900	50.4	388.9	135,100	188,800	53.7	395.7	124,000	210,200	185
190	46.3	378.6	136,900	156,400	48.7	384.4	129,600	182,500	52.2	391.8	118,800	203,100	190
195	44.6	373.5	131,500	150,900	47.1	379.8	124,400	176,400	50.6	387.6	113,900	196,400	195
200	42.8	368.0	126,400	145,800	45.3	374.8	119,500	170,400	48.9	383.2	109,300	190,000	200
205	40.9	362.2	121,500	140,900	43.5	369.5	114,800	164,600	47.2	378.5	104,900	183,900	205
210	38.9	356.0	116,800	136,300	41.7	363.8	110,300	159,000	45.5	373.6	100,700	178,200	210
215	36.9	349.3	112,400	131,900	39.7	357.8	106,100	153,700	43.7	368.3	96,600	172,700	215
220	34.7	342.1	108,100	127,900	37.7	351.3	102,000	148,700	41.9	362.7	92,800	167,400	220
230	30.0	325.6	100,200	120,900	33.4	336.7	94,300	139,400	37.9	350.3	85,600	157,700	230
240	24.4	305.2	92,800	115,400	28.4	319.3	87,200	131,600	33.6	335.8	79,000	148,700	240
250	17.0	277.1	85,800	112,300	22.5	297.2	80,600	125,500	28.7	318.6	72,800	140,400	250
260					14.1	264.9	74,300	112,600	22.8	296.8	67,000	132,800	260
270									14.7	265.4	61,400	117,900	270
280													280
290													290
300													300
310													310
320													320



# MLC650 VPC-MAX S-2

ASME B30.5

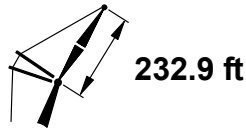
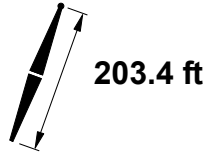

ft	75°				70°				65°			ft
	ft	lb	lb	lb	ft	lb	lb	lb	ft	lb		
95												95
100												100
105												105
110												110
115												115
120												120
125												125
130												130
135												135
140												140
145												145
150												150
155												155
160												160
165	64.6	414.8	127,100	201,800								165
170	63.2	412.3	121,300	201,800								170
175	61.8	409.5	115,800	201,800								175
180	60.3	406.6	110,600	201,800								180
185	58.9	403.6	105,700	196,600								185
190	57.4	400.3	101,100	189,900								190
195	55.9	396.9	96,700	183,500								195
200	54.4	393.3	92,500	177,500	59.5	399.1	76,100	165,200				200
205	52.9	389.5	88,500	171,700	58.0	396.0	72,500	159,800				205
210	51.3	385.4	84,700	166,300	56.5	392.6	69,100	154,600				210
215	49.7	381.1	81,100	161,100	55.0	389.1	65,900	149,700				215
220	48.0	376.6	77,700	156,100	53.5	385.3	62,800	145,000				220
230	44.6	366.7	71,200	146,800	50.3	377.2	57,000	136,300				230
240	40.8	355.4	65,200	138,400	47.0	368.0	51,700	128,300	52.3	375.4	118,500	240
250	36.8	342.5	59,700	130,600	43.4	357.7	46,800	120,900	49.1	366.9	111,500	250
260	32.4	327.4	54,600	123,300	39.6	346.0	42,300	114,100	45.7	357.3	105,100	260
270	27.3	309.1	49,800	116,600	35.5	332.4	38,000	107,800	42.1	346.5	99,200	270
280	21.0	285.6	45,200	110,400	30.9	316.5	34,000	101,900	38.2	334.2	93,600	280
290	11.5	248.7	40,600	104,400	25.5	296.9	30,200	96,400	33.9	319.8	88,500	290
300					18.6	270.8	26,500	91,200	29.0	302.8	83,600	300
310					5.7	219.5	22,600	86,100	23.2	281.3	79,100	310
320									15.3	250.7	74,700	320

# MLC650 VPC-MAX S-2

ASME B30.5



661,300 lb

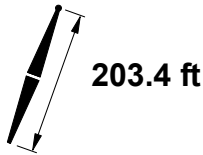

203.4 ft

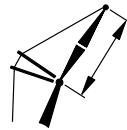

252.6 ft

ft	85°				83°				80°				ft
	ft	lb	lb	lb	ft	lb	lb	lb	ft	lb	lb	lb	
100	74.0	454.7	191,900	191,900									100
105	72.8	453.1	191,500	191,500									105
110	71.6	451.4	191,200	191,200									110
115	70.4	449.6	190,700	190,700	72.1	451.3	189,700	189,700					115
120	69.2	447.6	190,100	190,100	70.9	449.5	189,700	189,700					120
125	67.9	445.6	189,400	189,400	69.7	447.6	189,600	189,600					125
130	66.7	443.4	188,600	188,600	68.4	445.6	189,400	189,400					130
135	65.4	441.1	187,800	187,800	67.2	443.5	189,100	189,100	69.8	446.1	183,700	183,700	135
140	64.2	438.6	186,900	186,900	66.0	441.2	188,700	188,700	68.6	444.1	183,200	183,700	140
145	62.9	436.0	185,900	185,900	64.7	438.8	188,200	188,200	67.3	441.9	174,300	183,700	145
150	61.6	433.3	184,900	184,900	63.4	436.2	180,100	187,700	66.1	439.7	165,900	183,700	150
155	60.3	430.4	181,000	183,900	62.1	433.6	171,800	187,200	64.8	437.3	158,100	183,700	155
160	59.0	427.3	173,000	180,000	60.8	430.7	164,100	186,500	63.6	434.8	150,800	183,700	160
165	57.6	424.1	165,400	174,900	59.5	427.7	156,800	185,900	62.3	432.1	144,000	183,700	165
170	56.3	420.7	158,300	169,700	58.2	424.6	150,000	185,200	61.0	429.3	137,600	183,700	170
175	54.9	417.2	151,600	164,600	56.8	421.3	143,500	184,400	59.7	426.3	131,500	183,700	175
180	53.4	413.4	145,300	159,600	55.4	417.8	137,500	183,400	58.3	423.2	125,800	183,700	180
185	52.0	409.5	139,300	154,600	54.0	414.1	131,700	178,300	57.0	419.9	120,400	183,700	185
190	50.5	405.3	133,700	149,600	52.6	410.3	126,300	173,300	55.6	416.4	115,200	183,700	190
195	49.0	400.9	128,300	144,900	51.1	406.2	121,100	168,200	54.2	412.8	110,400	183,700	195
200	47.5	396.3	123,200	140,200	49.6	401.9	116,200	163,100	52.8	409.0	105,800	183,700	200
205	45.9	391.4	118,400	135,700	48.1	397.4	111,600	158,100	51.3	404.9	101,400	181,000	205
210	44.3	386.3	113,800	131,300	46.6	392.6	107,100	153,200	49.8	400.6	97,200	175,300	210
215	42.6	380.8	109,400	127,100	44.9	387.6	102,900	148,400	48.3	396.1	93,200	169,800	215
220	40.8	375.0	105,200	123,000	43.3	382.2	98,800	143,700	46.7	391.4	89,400	164,600	220
230	37.2	362.2	97,300	115,600	39.8	370.5	91,300	134,700	43.5	381.1	82,300	154,900	230
240	33.1	347.4	90,000	109,100	36.0	357.2	84,300	126,600	40.0	369.5	75,700	146,000	240
250	28.5	330.0	83,300	103,600	31.8	341.8	77,800	119,400	36.2	356.2	69,700	137,800	250
260	23.1	308.4	77,000	99,400	27.1	323.3	71,800	113,200	32.1	340.9	64,000	130,200	260
270	16.0	278.6	71,000	97,200	21.3	300.0	66,200	108,400	27.4	322.6	58,800	123,200	270
280					13.2	265.6	60,700	94,600	21.7	299.6	53,800	116,700	280
290									13.8	266.3	48,900	99,600	290
300													300
310													310
320													320
330													330
340													340

# MLC650 VPC-MAX S-2

ASME B30.5

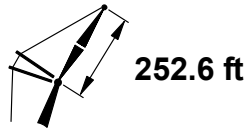
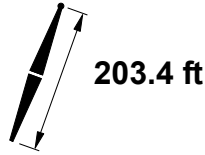

ft	75°				70°				65°				
	ft	°	ft	lb	ft	°	ft	lb	ft	°	ft	lb	
100													100
105													105
110													110
115													115
120													120
125													125
130													130
135													135
140													140
145													145
150													150
155													155
160													160
165													165
170													170
175	64.2	431.8	111,700	171,700									175
180	62.9	429.2	106,600	171,700									180
185	61.6	426.5	101,700	171,700									185
190	60.3	423.6	97,100	171,700									190
195	58.9	420.5	92,700	171,700									195
200	57.6	417.3	88,600	171,700									200
205	56.2	413.9	84,700	168,600									205
210	54.8	410.4	80,900	163,100	59.5	416.1	64,900	151,300					210
215	53.4	406.6	77,300	158,000	58.1	412.9	61,800	146,400					215
220	52.0	402.7	73,900	153,000	56.8	409.6	58,700	141,700					220
230	49.0	394.1	67,500	143,800	54.0	402.4	53,000	133,000					230
240	45.9	384.6	61,600	135,400	51.1	394.5	47,800	125,100					240
250	42.5	374.0	56,200	127,700	48.0	385.7	42,900	117,800	52.9	392.6	108,200		250
260	39.0	361.9	51,100	120,500	44.9	375.8	38,500	111,100	50.0	384.3	101,900		260
270	35.2	348.2	46,400	113,900	41.5	364.8	34,300	104,800	46.9	375.1	96,000		270
280	30.9	332.2	42,000	107,800	37.8	352.3	30,400	99,000	43.6	364.8	90,500		280
290	25.9	312.9	37,900	102,000	33.9	337.9	26,800	93,600	40.2	353.3	85,500		290
300	19.9	288.0	33,900	96,600	29.4	321.0	23,300	88,500	36.4	340.2	80,700		300
310	10.6	248.6	29,900	91,400	24.2	300.3	20,000	83,800	32.3	325.0	76,200		310
320					17.5	272.7		79,200	27.6	306.9	72,000		320
330					4.4	215.6		74,700	22.0	284.2	68,000		330
340									14.3	251.8	64,100		340

# MLC650 VPC-MAX S-2

ASME B30.5



661,300 lb



360°

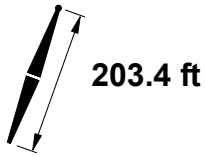

203.4 ft

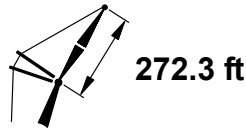

272.3 ft

ft	85°				83°				80°				ft
	ft	lb	lb	lb	ft	lb	lb	lb	ft	lb	lb	lb	
105	74.1	473.8	166,600	166,600									105
110	73.0	472.2	165,900	165,900									110
115	71.9	470.5	165,500	165,500									115
120	70.7	468.7	165,000	165,000	72.3	470.4	164,300	164,300					120
125	69.6	466.8	164,400	164,400	71.2	468.6	164,200	164,200					125
130	68.5	464.8	163,800	163,800	70.1	466.8	164,000	164,000					130
135	67.3	462.7	163,100	163,100	69.0	464.8	163,800	163,800					135
140	66.2	460.5	162,300	162,300	67.8	462.7	163,400	163,400					140
145	65.0	458.1	161,500	161,500	66.7	460.5	163,100	163,100	69.1	463.3	159,400	159,400	145
150	63.8	455.6	160,700	160,700	65.5	458.2	162,600	162,600	67.9	461.2	159,400	159,400	150
155	62.7	453.0	159,800	159,800	64.3	455.8	162,100	162,100	66.8	459.0	155,600	159,400	155
160	61.5	450.2	158,900	158,900	63.1	453.2	161,600	161,600	65.6	456.7	148,300	159,400	160
165	60.2	447.3	158,000	158,000	62.0	450.5	154,600	161,000	64.5	454.3	141,500	159,400	165
170	59.0	444.3	156,300	157,000	60.7	447.7	147,800	160,400	63.3	451.8	135,100	159,400	170
175	57.8	441.1	149,600	153,100	59.5	444.7	141,400	159,700	62.1	449.1	129,100	159,400	175
180	56.5	437.7	143,300	149,000	58.3	441.6	135,300	159,100	60.9	446.2	123,400	159,400	180
185	55.2	434.2	137,400	144,900	57.0	438.3	129,600	158,400	59.7	443.3	118,000	159,400	185
190	53.9	430.5	131,800	140,700	55.7	434.8	124,200	157,600	58.4	440.2	112,900	159,300	190
195	52.6	426.7	126,400	136,700	54.4	431.2	119,100	156,900	57.2	436.9	108,100	159,000	195
200	51.2	422.6	121,400	132,600	53.1	427.4	114,200	152,800	55.9	433.5	103,500	158,700	200
205	49.8	418.4	116,500	128,700	51.8	423.5	109,500	148,700	54.6	429.9	99,100	158,400	205
210	48.4	413.9	111,900	124,800	50.4	419.3	105,100	144,600	53.3	426.1	95,000	158,100	210
215	47.0	409.2	107,600	121,100	49.0	414.9	100,900	140,500	51.9	422.2	91,000	157,800	215
220	45.5	404.2	103,400	117,400	47.6	410.3	96,900	136,500	50.6	418.0	87,300	157,300	220
230	42.4	393.5	95,600	110,400	44.6	400.4	89,400	128,700	47.7	409.1	80,200	153,100	230
240	39.1	381.5	88,400	104,100	41.5	389.3	82,500	121,200	44.8	399.2	73,700	144,200	240
250	35.6	368.0	81,700	98,300	38.1	376.9	76,100	114,300	41.7	388.2	67,700	136,100	250
260	31.7	352.4	75,600	93,200	34.5	362.8	70,200	107,900	38.3	375.9	62,200	128,600	260
270	27.3	334.0	69,800	88,900	30.5	346.5	64,700	102,200	34.7	361.9	57,000	121,600	270
280	22.1	311.3	64,400	85,800	25.9	327.1	59,500	97,400	30.7	345.7	52,200	115,200	280
290	15.1	279.9	59,200	82,700	20.3	302.5	54,600	93,900	26.1	326.5	47,600	109,100	290
300					12.3	266.2	49,900	79,800	20.6	302.3	43,300	100,000	300
310									12.9	267.0	39,100	84,400	310
320													320
330													330
340													340
350													350
360													360

# MLC650 VPC-MAX S-2

ASME B30.5

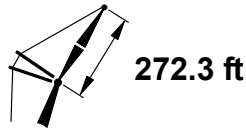
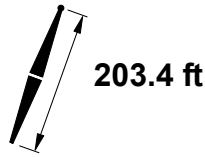

ft	75°				70°				65°				ft
	ft	°	lb	lb	ft	°	lb	lb	ft	°	lb	lb	
105													105
110													110
115													115
120													120
125													125
130													130
135													135
140													140
145													145
150													150
155													155
160													160
165													165
170													170
175													175
180	65.0	451.3	103,800	148,100									180
185	63.8	448.8	99,000	148,100									185
190	62.6	446.2	94,400	148,100									190
195	61.4	443.4	90,100	148,100									195
200	60.2	440.5	86,000	148,100									200
205	59.0	437.5	82,100	148,100									205
210	57.7	434.3	78,300	148,100									210
215	56.5	431.0	74,800	148,100									215
220	55.2	427.4	71,400	148,100	59.5	433.1	55,900	137,200					220
230	52.6	419.9	65,100	141,800	57.0	426.6	50,300	130,800					230
240	49.8	411.6	59,200	133,500	54.4	419.5	45,100	122,900					240
250	47.0	402.4	53,900	125,800	51.7	411.8	40,300	115,700					250
260	44.0	392.2	48,900	118,700	48.9	403.2	35,900	109,000	53.4	409.7	99,600		260
270	40.8	380.9	44,300	112,100	46.0	393.7	31,800	102,800	50.7	401.7	93,800		270
280	37.4	368.2	40,000	106,000	43.0	383.2	28,000	97,100	47.9	392.8	88,400		280
290	33.7	353.6	36,000	100,300	39.7	371.5	24,500	91,700	44.9	382.9	83,400		290
300	29.5	336.8	32,200	95,000	36.3	358.2	21,100	86,700	41.8	372.0	78,700		300
310	24.8	316.5	28,500	90,000	32.4	343.1		82,100	38.5	359.7	74,300		310
320	18.9	290.3	25,000	85,300	28.1	325.3		77,600	34.9	345.9	70,200		320
330	9.8	248.2	21,500	80,700	23.1	303.5		73,500	30.9	329.8	66,300		330
340					16.6	274.3		69,500	26.4	310.8	62,600		340
350					2.6	208.8		65,400	21.0	286.9	59,000		350
360									13.4	252.6	55,600		360

# MLC650 VPC-MAX S-2

ASME B30.5



661,300 lb

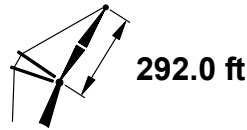
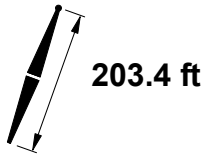

ft	85°				83°				80°				ft
	ft	lb	lb	lb	ft	lb	lb	lb	ft	lb	lb	lb	
110	74.2	492.8	142,500	142,500									110
115	73.1	491.3	142,100	142,100									115
120	72.1	489.6	141,600	141,600									120
125	71.1	487.9	141,100	141,100	72.5	489.4	140,400	140,400					125
130	70.0	486.0	140,500	140,500	71.5	487.7	140,200	140,200					130
135	69.0	484.0	139,900	139,900	70.4	485.9	139,900	139,900					135
140	67.9	482.0	139,200	139,200	69.4	484.0	139,500	139,500					140
145	66.8	479.8	138,400	138,400	68.3	482.0	139,100	139,100					145
150	65.7	477.5	137,700	137,700	67.3	479.9	138,700	138,700	69.5	482.5	135,500	135,500	150
155	64.7	475.1	136,900	136,900	66.2	477.6	138,200	138,200	68.4	480.5	135,500	135,500	155
160	63.6	472.6	136,100	136,100	65.1	475.3	137,700	137,700	67.4	478.3	135,500	135,500	160
165	62.4	469.9	135,300	135,300	64.0	472.8	137,100	137,100	66.3	476.1	135,400	135,400	165
170	61.3	467.2	134,400	134,400	62.9	470.2	136,500	136,500	65.2	473.8	131,100	135,300	170
175	60.2	464.3	133,600	133,600	61.8	467.5	135,900	135,900	64.1	471.3	125,100	135,100	175
180	59.0	461.2	132,700	132,700	60.7	464.6	131,500	135,300	63.0	468.7	119,400	134,900	180
185	57.9	458.1	131,900	131,900	59.5	461.7	125,800	134,600	61.9	466.0	114,000	134,700	185
190	56.7	454.7	128,100	130,600	58.4	458.5	120,400	133,900	60.8	463.2	109,000	134,400	190
195	55.5	451.3	122,800	127,300	57.2	455.3	115,300	133,300	59.6	460.2	104,200	134,100	195
200	54.3	447.6	117,800	124,000	56.0	451.9	110,500	132,600	58.5	457.1	99,600	133,700	200
205	53.1	443.8	113,000	120,700	54.8	448.3	105,800	131,900	57.3	453.9	95,200	133,400	205
210	51.8	439.9	108,400	117,400	53.6	444.6	101,400	131,200	56.1	450.5	91,100	133,000	210
215	50.5	435.7	104,000	114,200	52.3	440.7	97,300	130,500	54.9	447.0	87,200	132,600	215
220	49.2	431.4	99,900	111,000	51.1	436.6	93,300	128,000	53.7	443.2	83,400	132,100	220
230	46.6	422.1	92,100	104,900	48.5	427.9	85,800	121,500	51.2	435.3	76,400	131,300	230
240	43.7	411.8	84,900	99,000	45.7	418.3	78,900	115,100	48.6	426.6	69,900	130,400	240
250	40.8	400.5	78,300	93,600	42.9	407.7	72,600	108,900	45.9	417.1	64,000	129,600	250
260	37.6	387.8	72,200	88,500	39.9	396.0	66,700	103,000	43.0	406.6	58,500	125,600	260
270	34.2	373.5	66,600	83,900	36.6	382.9	61,300	97,500	40.0	395.0	53,400	118,700	270
280	30.4	357.2	61,300	79,900	33.1	368.1	56,200	92,500	36.8	381.9	48,600	112,300	280
290	26.2	337.9	56,300	76,600	29.2	351.0	51,500	88,100	33.3	367.2	44,200	106,300	290
300	21.1	314.1	51,600	74,100	24.8	330.6	47,000	84,300	29.5	350.3	40,000	100,700	300
310	14.3	281.0	47,000	67,800	19.4	304.9	42,700	79,600	25.0	330.1	36,000	95,400	310
320					11.6	266.4	38,500	65,300	19.7	304.7	32,200	83,500	320
330									12.1	267.5	28,500	69,500	330
340													340
350													350
360													360
370													370
380													380

# MLC650 VPC-MAX S-2

ASME B30.5

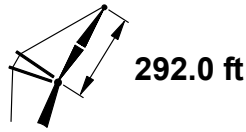
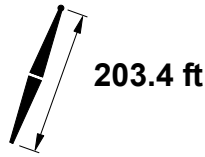
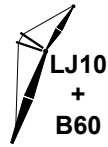

ft	75°				70°				65°				
	ft	°	ft	lb	ft	°	ft	lb	ft	°	ft	lb	
110													110
115													115
120													120
125													125
130													130
135													135
140													140
145													145
150													150
155													155
160													160
165													165
170													170
175													175
180													180
185													185
190	64.6	468.3	90,100	125,300									190
195	63.5	465.8	85,800	125,300									195
200	62.4	463.2	81,700	125,300									200
205	61.3	460.4	77,800	125,300									205
210	60.2	457.5	74,200	125,300									210
215	59.0	454.5	70,600	125,300									215
220	57.9	451.3	67,300	125,300									220
230	55.5	444.5	61,000	125,300	59.5	450.0	45,900	115,100					230
240	53.0	437.1	55,200	125,300	57.1	443.6	40,800	115,100					240
250	50.5	428.9	49,900	122,600	54.7	436.6	36,100	112,300					250
260	47.9	420.0	45,000	115,500	52.3	429.0	31,700	105,700					260
270	45.1	410.3	40,400	109,000	49.7	420.6	27,700	99,600	53.8	426.8	90,400		270
280	42.3	399.5	36,200	103,000	47.0	411.5	23,900	93,900	51.3	418.9	85,000		280
290	39.2	387.5	32,200	97,300	44.3	401.4	20,400	88,600	48.7	410.3	80,100		290
300	35.9	374.1	28,400	92,100	41.3	390.3		83,600	46.0	400.8	75,400		300
310	32.3	358.8	24,900	87,100	38.2	377.9		79,000	43.2	390.4	71,000		310
320	28.3	341.1	21,600	82,500	34.8	363.9		74,600	40.2	378.8	67,000		320
330	23.7	319.8		78,100	31.1	348.0		70,500	37.0	365.9	63,100		330
340	18.0	292.3		73,900	27.0	329.3		66,600	33.5	351.3	59,500		340
350	9.0	247.6		69,900	22.1	306.5		62,900	29.7	334.4	56,000		350
360					15.8	275.8		59,400	25.3	314.5	52,800		360
370									20.0	289.4	49,600		370
380									12.6	253.3	46,600		380

# MLC650 VPC-MAX S-2

ASME B30.5

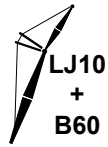

661,300 lb

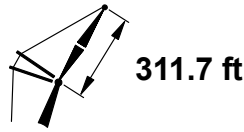
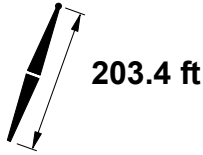

ft	85°				83°				80°				ft
	ft	lb	lb	lb	ft	lb	lb	lb	ft	lb	lb	lb	
115	74.2	511.9	123,400	123,400									115
120	73.3	510.3	122,700	122,700									120
125	72.3	508.7	122,200	122,200									125
130	71.3	507.0	121,700	121,700	72.7	508.5	121,100	121,100					130
135	70.3	505.2	121,100	121,100	71.7	506.8	120,900	120,900					135
140	69.4	503.2	120,500	120,500	70.8	505.1	120,500	120,500					140
145	68.4	501.2	119,900	119,900	69.8	503.2	120,100	120,100					145
150	67.4	499.1	119,200	119,200	68.8	501.2	119,700	119,700					150
155	66.4	496.9	118,600	118,600	67.8	499.1	119,200	119,200	69.9	501.6	116,400	116,400	155
160	65.4	494.6	117,900	117,900	66.8	497.0	118,800	118,800	68.9	499.7	116,400	116,400	160
165	64.3	492.1	117,100	117,100	65.8	494.7	118,300	118,300	67.9	497.6	116,300	116,300	165
170	63.3	489.6	116,400	116,400	64.8	492.3	117,700	117,700	66.9	495.5	116,100	116,100	170
175	62.3	486.9	115,600	115,600	63.7	489.8	117,200	117,200	65.9	493.2	115,900	115,900	175
180	61.2	484.1	114,900	114,900	62.7	487.2	116,600	116,600	64.9	490.8	115,700	115,700	180
185	60.1	481.2	114,100	114,100	61.6	484.4	116,000	116,000	63.8	488.3	111,700	115,400	185
190	59.1	478.2	113,300	113,300	60.6	481.6	115,400	115,400	62.8	485.7	106,600	115,200	190
195	58.0	475.0	112,600	112,600	59.5	478.6	113,200	114,800	61.8	483.0	101,800	114,900	195
200	56.9	471.7	111,800	111,800	58.4	475.5	108,300	114,300	60.7	480.2	97,300	114,500	200
205	55.8	468.3	111,000	111,000	57.3	472.3	103,700	113,600	59.6	477.2	93,000	114,200	205
210	54.6	464.7	106,400	109,100	56.2	468.9	99,400	112,900	58.5	474.1	88,800	113,800	210
215	53.5	461.0	102,100	106,400	55.1	465.4	95,200	112,300	57.5	470.9	84,900	113,400	215
220	52.3	457.1	97,900	103,700	54.0	461.7	91,200	111,700	56.3	467.5	81,200	113,000	220
230	49.9	448.8	90,200	98,500	51.6	453.9	83,700	110,400	54.1	460.4	74,200	112,200	230
240	47.5	439.7	83,100	93,300	49.2	445.4	76,900	107,700	51.8	452.6	67,800	111,400	240
250	44.9	429.9	76,500	88,400	46.7	436.1	70,600	102,500	49.3	444.1	61,900	110,500	250
260	42.2	419.0	70,500	83,700	44.1	425.9	64,800	97,300	46.8	434.9	56,400	109,700	260
270	39.3	407.1	64,800	79,400	41.3	414.8	59,400	92,400	44.2	424.8	51,300	108,900	270
280	36.2	393.8	59,600	75,300	38.4	402.5	54,400	87,700	41.5	413.7	46,600	108,100	280
290	32.9	378.8	54,700	71,700	35.3	388.7	49,700	83,300	38.6	401.4	42,200	103,000	290
300	29.3	361.7	50,100	68,500	31.9	373.2	45,300	79,300	35.5	387.8	38,100	98,100	300
310	25.1	341.5	45,800	65,900	28.1	355.3	41,100	75,700	32.1	372.3	34,200	93,400	310
320	20.2	316.6	41,600	64,000	23.8	334.0	37,200	72,800	28.3	354.6	30,500	89,000	320
330	13.6	281.9	37,600	56,200	18.5	307.0	33,400	67,000	24.1	333.5	27,100	81,100	330
340					10.8	266.5	29,600	53,900	18.8	306.9	23,700	70,500	340
350									11.4	267.7	20,300	57,900	350
360													360
370													370
380													380
390													390
400													400



# MLC650 VPC-MAX S-2

ASME B30.5

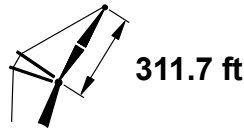
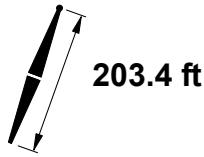

ft	75°				70°			65°			ft
	ft	lb	lb	lb	ft	lb	lb	ft	lb	lb	
115											115
120											120
125											125
130											130
135											135
140											140
145											145
150											150
155											155
160											160
165											165
170											170
175											175
180											180
185											185
190											190
195											195
200	64.3	485.4	79,100	107,200							200
205	63.3	482.8	75,200	107,200							205
210	62.2	480.1	71,600	107,200							210
215	61.2	477.4	68,100	107,200							215
220	60.1	474.5	64,700	107,200							220
230	58.0	468.3	58,500	107,200							230
240	55.7	461.5	52,700	107,200	59.5	467.0	97,900				240
250	53.5	454.2	47,500	107,200	57.3	460.6	97,900				250
260	51.1	446.2	42,600	107,200	55.0	453.7	97,900				260
270	48.7	437.6	38,100	107,100	52.7	446.2	97,500				270
280	46.2	428.1	33,900	101,100	50.4	438.0	91,800	54.2	443.9	82,900	280
290	43.5	417.8	29,900	95,500	47.9	429.1	86,600	51.9	436.2	77,900	290
300	40.7	406.4	26,300	90,300	45.3	419.4	81,700	49.5	427.8	73,300	300
310	37.8	393.8	22,800	85,400	42.7	408.7	77,100	47.0	418.6	69,000	310
320	34.6	379.7		80,800	39.8	397.0	72,800	44.4	408.5	64,900	320
330	31.1	363.7		76,500	36.8	383.9	68,700	41.6	397.5	61,100	330
340	27.3	345.2		72,400	33.5	369.3	64,900	38.7	385.3	57,500	340
350	22.8	322.9		68,500	30.0	352.6	61,200	35.6	371.7	54,200	350
360	17.2	294.1		64,800	25.9	333.1	57,800	32.3	356.4	50,900	360
370	8.2	246.6		58,300	21.2	309.3	54,500	28.6	338.8	47,900	370
380					15.0	277.1	51,300	24.3	317.9	45,000	380
390								19.1	291.8	42,200	390
400								11.9	253.7	39,400	400

# MLC650 VPC-MAX S-2

ASME B30.5



661,300 lb

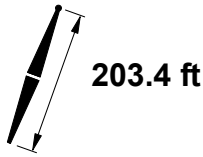

203.4 ft

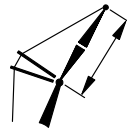

331.4 ft

ft	85°				83°				80°				ft
	ft	lb	lb	lb	ft	lb	lb	lb	ft	lb	lb	lb	
120	74.3	530.9	106,100	106,100									120
125	73.4	529.4	105,600	105,600									125
130	72.5	527.8	105,000	105,000									130
135	71.6	526.1	104,400	104,400	72.9	527.6	103,800	103,800					135
140	70.6	524.3	103,900	103,900	71.9	525.9	103,600	103,600					140
145	69.7	522.4	103,300	103,300	71.0	524.2	103,200	103,200					145
150	68.8	520.4	102,700	102,700	70.1	522.3	102,800	102,800					150
155	67.9	518.4	102,000	102,000	69.2	520.4	102,300	102,300					155
160	66.9	516.2	101,400	101,400	68.2	518.4	101,800	101,800					160
165	66.0	514.0	100,700	100,700	67.3	516.3	101,300	101,300	69.3	518.9	99,200	99,200	165
170	65.0	511.6	100,000	100,000	66.4	514.0	100,800	100,800	68.3	516.9	99,000	99,000	170
175	64.0	509.1	99,300	99,300	65.4	511.7	100,300	100,300	67.4	514.8	98,800	98,800	175
180	63.1	506.6	98,600	98,600	64.4	509.3	99,700	99,700	66.5	512.5	98,500	98,500	180
185	62.1	503.9	97,900	97,900	63.5	506.8	99,200	99,200	65.5	510.2	98,200	98,200	185
190	61.1	501.1	97,200	97,200	62.5	504.1	98,600	98,600	64.5	507.8	97,900	97,900	190
195	60.1	498.2	96,500	96,500	61.5	501.4	98,100	98,100	63.6	505.3	97,600	97,600	195
200	59.1	495.2	95,800	95,800	60.5	498.5	97,500	97,500	62.6	502.7	93,400	97,300	200
205	58.1	492.0	95,100	95,100	59.5	495.6	96,900	96,900	61.6	500.0	89,100	97,000	205
210	57.0	488.7	94,400	94,400	58.5	492.5	95,800	96,300	60.6	497.1	85,000	96,600	210
215	56.0	485.3	93,800	93,800	57.5	489.2	91,600	95,800	59.6	494.1	81,100	96,200	215
220	54.9	481.8	93,100	93,100	56.4	485.9	87,600	95,200	58.6	491.1	77,400	95,800	220
230	52.8	474.3	86,700	90,700	54.3	478.8	80,200	94,000	56.5	484.5	70,400	95,100	230
240	50.5	466.1	79,600	86,400	52.1	471.1	73,400	92,900	54.4	477.4	64,100	94,200	240
250	48.2	457.3	73,100	82,100	49.9	462.8	67,100	91,700	52.2	469.8	58,200	93,400	250
260	45.8	447.8	67,100	78,000	47.5	453.8	61,300	90,200	50.0	461.5	52,800	92,600	260
270	43.3	437.3	61,500	74,000	45.1	443.9	56,000	85,900	47.7	452.5	47,700	91,800	270
280	40.7	425.9	56,300	70,300	42.6	433.3	51,000	81,800	45.3	442.8	43,000	91,100	280
290	38.0	413.4	51,400	66,800	39.9	421.5	46,300	77,800	42.7	432.1	38,700	90,300	290
300	35.0	399.5	46,900	63,600	37.1	408.6	41,900	74,100	40.1	420.5	34,600	89,700	300
310	31.8	383.9	42,600	60,700	34.1	394.2	37,800	70,700	37.3	407.6	30,800	85,300	310
320	28.2	366.0	38,600	58,200	30.8	378.0	34,000	67,400	34.2	393.3	27,100	79,300	320
330	24.2	345.0	34,700	56,100	27.1	359.4	30,300	64,400	31.0	377.2	23,700	73,300	330
340	19.4	319.0	31,000	53,100	22.9	337.2	26,800	58,600	27.3	358.7	20,500	67,300	340
350	12.9	282.6	27,400	44,300	17.7	309.0	23,400	53,100	23.2	336.7		61,300	350
360					10.2	266.3	20,100	42,300	18.1	309.0		55,500	360
370									10.7	267.7		46,000	370
380													380
390													390
400													400
410													410
420													420

# MLC650 VPC-MAX S-2

ASME B30.5

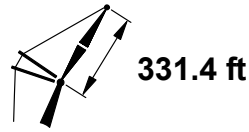
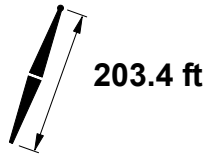
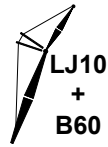

ft	75°				70°			65°			ft
	°	ft	lb	lb	°	ft	lb	°	ft	lb	
120											120
125											125
130											130
135											135
140											140
145											145
150											150
155											155
160											160
165											165
170											170
175											175
180											180
185											185
190											190
195											195
200											200
205	65.0	504.8	71,100	90,500							205
210	64.0	502.4	67,500	90,500							210
215	63.1	499.8	64,000	90,500							215
220	62.1	497.1	60,700	90,500							220
230	60.1	491.4	54,400	90,500							230
240	58.1	485.2	48,800	90,500							240
250	56.0	478.5	43,500	90,500	59.5	483.9	82,200				250
260	53.8	471.3	38,700	90,500	57.4	477.6	82,200				260
270	51.6	463.5	34,200	90,500	55.3	470.7	82,200				270
280	49.4	455.0	30,000	90,400	53.2	463.3	82,200				280
290	47.0	445.8	26,100	90,100	50.9	455.3	82,200	54.5	461.0	74,600	290
300	44.6	435.9	22,500	87,300	48.7	446.6	78,600	52.4	453.4	70,100	300
310	42.0	425.0		82,500	46.3	437.2	74,000	50.1	445.1	65,800	310
320	39.3	413.0		77,900	43.8	427.0	69,700	47.8	436.2	61,800	320
330	36.5	399.8		73,600	41.2	415.7	65,700	45.4	426.5	58,000	330
340	33.4	385.1		69,600	38.5	403.4	61,900	42.9	415.9	54,400	340
350	30.0	368.4		65,800	35.5	389.8	58,300	40.2	404.3	51,100	350
360	26.3	349.1		62,100	32.4	374.5	54,900	37.4	391.5	47,900	360
370	21.9	325.9		58,700	28.9	357.1	51,700	34.4	377.3	44,900	370
380	16.4	295.8		55,400	25.0	336.7	48,600	31.1	361.3	42,000	380
390	7.5	245.2		46,400	20.4	311.9	45,700	27.5	342.9	39,300	390
400					14.3	278.2	42,800	23.4	321.2	36,700	400
410								18.4	293.9	34,100	410
420								11.2	253.8	31,600	420

# MLC650 VPC-MAX S-2

ASME B30.5



**661,300 lb**

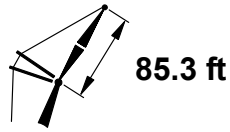
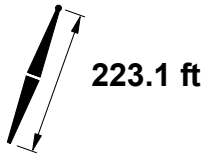

ft	85°				83°				80°				ft
	ft	lb	lb	lb	ft	lb	lb	lb	ft	lb	lb	lb	
55	74.3	313.7	594,200 d	594,200 d									55
60	70.7	311.8	577,200 c	577,200 c									60
65	67.1	309.6	548,800 c	560,700 c	72.7	312.0	527,800 c	593,300 c					65
70	63.3	306.9	503,200 c	536,100 c	69.1	309.9	483,900 c	577,500 c					70
75	59.3	303.9	464,000 b	496,000 b	65.4	307.5	446,200 c	561,800 c					75
80	55.2	300.3	430,000 b	462,200 b	61.5	304.7	413,500 b	546,800 b					80
85	50.8	296.1	400,100	433,500	57.5	301.4	384,800 b	517,200 b	66.6	306.4	361,700 c	574,600 c	85
90	46.1	291.2	373,700	409,500	53.3	297.5	359,400 b	482,000 b	62.7	303.7	337,800 b	536,900 b	90
95	41.0	285.3	350,100	389,900	48.8	293.0	336,700	452,300	58.8	300.6	316,500 b	503,700 b	95
100	35.1	278.2	328,800	374,700	43.9	287.7	316,300	427,700	54.6	296.9	297,400 b	474,000 b	100
105	28.1	269.0	309,400	364,800	38.4	281.4	297,900	407,600	50.2	292.6	280,100	447,500	105
110	18.5	255.5	291,400	353,700	32.2	273.5	281,000	392,500	45.4	287.6	264,300	423,500	110
115					24.3	262.9	265,400	383,500	40.2	281.6	249,900	401,800	115
120					11.1	243.8	250,300	316,300	34.2	274.3	236,600	382,000	120
125									27.0	264.7	224,200	363,800	125
130									16.6	250.1	212,400	346,900	130
135													135
140													140
145													145
150													150
155													155
160													160
165													165
170													170
175													175
180													180
185													185

# MLC650 VPC-MAX S-2

ASME B30.5

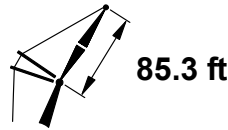
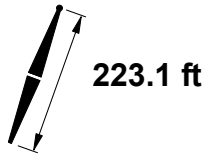
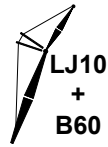

ft	75°				70°				65°				ft
	ft	lb	lb	lb	ft	lb	lb	lb	ft	lb	lb	lb	
55													55
60													60
65													65
70													70
75													75
80													80
85													85
90													90
95													95
100													100
105													105
110	62.0	298.6	236,000 b	401,500 b									110
115	58.0	295.4	223,200 b	380,900 b									115
120	53.7	291.6	211,400 b	362,200 b									120
125	49.3	287.2	200,500	345,000									125
130	44.4	282.0	190,400	329,200									130
135	39.1	275.7	181,000	314,700	56.7	288.2	159,100	297,700					135
140	32.9	268.1	172,200	301,100	52.5	284.2	151,400	285,000					140
145	25.3	257.9	163,800	288,500	47.9	279.6	144,200	273,100					145
150	13.4	240.8	155,400	276,500	42.9	274.1	137,400	262,100					150
155					37.4	267.5	130,900	251,800	55.0	278.9	112,600	237,800	155
160					30.9	259.2	124,800	242,100	50.6	274.7	107,400	228,700	160
165					22.5	247.9	118,800	232,800	45.9	269.7	102,400	220,100	165
170									40.7	263.8	97,600	212,100	170
175									34.8	256.6	93,100	204,400	175
180									27.7	247.3	88,600	197,200	180
185									17.8	233.4	84,100	190,100	185

# MLC650 VPC-MAX S-2

ASME B30.5

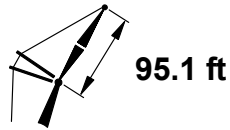
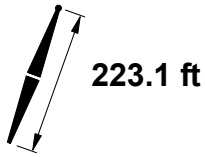

ft	85°				83°				80°				ft
	ft	lb	lb	lb	ft	lb	lb	lb	ft	lb	lb	lb	
60	72.8	322.3	549,700 c	549,700 c									60
65	69.6	320.4	534,900 c	534,900 c									65
70	66.3	318.1	500,700 b	520,200 b	71.4	320.6	481,100 c	550,200 c					70
75	62.9	315.4	461,600 b	493,400 b	68.1	318.5	443,500 b	536,100 b					75
80	59.4	312.3	427,700 b	458,900 b	64.8	316.0	410,800 b	522,200 b					80
85	55.7	308.8	398,000	429,200	61.3	313.2	382,200 b	508,800 b	69.2	317.3	358,700 b	549,500 b	85
90	51.8	304.8	371,700	403,800	57.7	309.9	357,000 b	481,700 b	65.8	314.9	334,900 b	533,800 b	90
95	47.7	300.1	348,200	382,100	54.0	306.1	334,400	450,400	62.4	312.2	313,600 b	500,700 b	95
100	43.3	294.7	327,200	363,900	50.0	301.8	314,200	423,700	58.9	309.1	294,600 b	471,300 b	100
105	38.4	288.4	308,100	349,100	45.8	296.9	295,900	401,100	55.2	305.5	277,500	444,900	105
110	32.9	280.7	290,700	337,900	41.1	291.1	279,300	382,200	51.3	301.3	261,900	421,000	110
115	26.2	270.8	274,700	331,200	36.0	284.2	264,100	367,000	47.1	296.6	247,600	399,400	115
120	16.9	256.2	259,700	318,300	30.1	275.6	250,000	355,900	42.6	291.1	234,600	379,800	120
125					22.6	264.2	236,900	350,000	37.7	284.6	222,500	361,800	125
130					9.5	243.2	224,000	285,700	32.0	276.6	211,300	345,200	130
135									25.2	266.3	200,700	329,800	135
140									15.1	250.4	190,500	315,500	140
145													145
150													150
155													155
160													160
165													165
170													170
175													175
180													180
185													185
190													190
195													195

# MLC650 VPC-MAX S-2

ASME B30.5

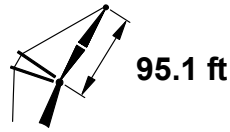
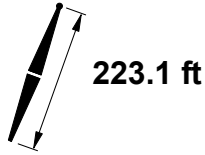

ft	75°				70°				65°				ft
	ft	°	ft	lb	ft	°	ft	lb	ft	°	ft	lb	
60													60
65													65
70													70
75													75
80													80
85													85
90													90
95													95
100													100
105													105
110													110
115	61.7	307.1	220,000 b	378,100 b									115
120	58.1	303.9	208,300	359,400									120
125	54.4	300.2	197,600	342,400									125
130	50.4	295.9	187,700	326,700									130
135	46.2	291.1	178,400	312,300									135
140	41.7	285.4	169,800	298,900	57.0	296.7	148,100	282,200					140
145	36.6	278.6	161,800	286,500	53.2	292.9	141,000	270,500					145
150	30.8	270.3	154,100	274,800	49.2	288.4	134,400	259,600					150
155	23.5	259.3	146,800	263,900	44.9	283.3	128,100	249,400					155
160	11.9	240.7	139,400	253,500	40.2	277.4	122,200	239,800					160
165					35.0	270.2	116,600	230,800	51.6	283.4	99,200	217,500	165
170					28.8	261.3	111,200	222,300	47.5	278.7	94,600	209,600	170
175					20.8	249.0	105,900	214,200	43.0	273.2	90,200	202,000	175
180									38.1	266.8	86,000	194,900	180
185									32.6	259.0	81,900	188,200	185
190									25.8	249.0	77,900	181,700	190
195									16.3	234.0	73,800	175,400	195

# MLC650 VPC-MAX S-2

ASME B30.5

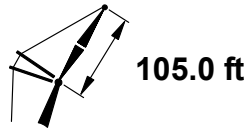
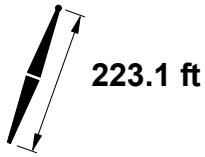

ft	85°				83°				80°				ft
	ft	lb	lb	lb	ft	lb	lb	lb	ft	lb	lb	lb	
60	74.5	332.7	509,200 c	509,200 c									60
65	71.6	331.0	507,700 c	507,700 c									65
70	68.7	328.9	499,700 b	499,700 b									70
75	65.7	326.6	486,500 b	486,500 b	70.3	329.2	469,000 b	512,100 b					75
80	62.6	323.9	451,800 b	456,100 b	67.3	327.0	434,600 b	501,700 b					80
85	59.4	320.8	420,600	426,000	64.3	324.5	404,500 b	489,300 b					85
90	56.0	317.4	393,000	399,900	61.1	321.6	377,900 b	477,300 b	68.3	325.8	355,400 b	512,800 b	90
95	52.6	313.4	368,400	377,300	57.9	318.4	354,300	449,900	65.2	323.4	333,000 b	498,800 b	95
100	48.9	309.0	346,400	357,700	54.5	314.7	333,000	422,100	62.1	320.6	313,000 b	469,400 b	100
105	45.0	303.9	326,500	341,000	51.0	310.6	313,900	398,000	58.9	317.5	294,900	443,100	105
110	40.9	298.1	308,400	327,000	47.2	305.9	296,500	377,400	55.6	314.0	278,500	419,400	110
115	36.2	291.2	291,800	315,800	43.2	300.5	280,600	359,800	52.1	310.0	263,600	398,000	115
120	31.0	282.9	276,600	307,500	38.8	294.2	266,000	345,200	48.4	305.5	249,900	378,400	120
125	24.6	272.4	262,500	303,200	34.0	286.8	252,600	333,500	44.5	300.3	237,300	360,500	125
130	15.6	256.7	249,100	291,900	28.3	277.6	240,100	325,300	40.2	294.4	225,600	344,000	130
135					21.1	265.4	228,300	321,800	35.5	287.3	214,800	328,800	135
140					8.1	242.2	216,600	260,100	30.2	278.8	204,700	314,800	140
145									23.6	267.8	195,000	301,700	145
150									13.8	250.7	185,700	289,300	150
155													155
160													160
165													165
170													170
175													175
180													180
185													185
190													190
195													195
200													200
205													205



# MLC650 VPC-MAX S-2

ASME B30.5

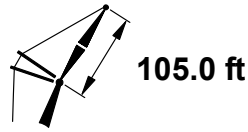
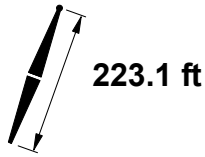
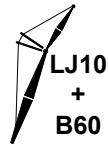

ft	75°				70°				65°				ft
	ft	°	ft	lb	ft	°	ft	lb	ft	°	ft	lb	
60													60
65													65
70													70
75													75
80													80
85													85
90													90
95													95
100													100
105													105
110													110
115	64.6	318.4	235,300	376,300									115
120	61.5	315.6	223,000	357,700									120
125	58.2	312.4	211,700	340,800									125
130	54.9	308.8	201,200	325,200									130
135	51.4	304.7	191,500	310,800									135
140	47.6	300.0	182,500	297,500									140
145	43.7	294.7	174,000	285,200	57.3	305.2	152,700	268,900					145
150	39.3	288.5	166,100	273,700	53.9	301.5	145,700	258,100					150
155	34.5	281.3	158,700	263,000	50.3	297.2	139,100	247,900					155
160	28.9	272.3	151,600	252,900	46.5	292.4	132,900	238,500					160
165	22.0	260.6	144,800	243,400	42.4	286.8	127,000	229,600					165
170	10.6	240.3	137,900	234,200	38.0	280.4	121,500	221,200	52.4	292.0	104,200	208,000	170
175					33.0	272.7	116,200	213,300	48.7	287.6	99,600	200,600	175
180					27.1	263.1	111,100	205,800	44.8	282.4	95,200	193,600	180
185					19.4	250.0	106,000	198,600	40.6	276.6	91,000	187,000	185
190									36.0	269.6	86,900	180,700	190
195									30.7	261.3	83,000	174,600	195
200									24.2	250.6	79,200	168,900	200
205									15.0	234.4	75,300	163,200	205

# MLC650 VPC-MAX S-2

ASME B30.5



661,300 lb

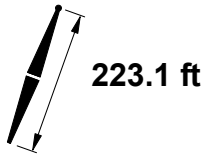

223.1 ft

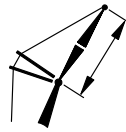

114.8 ft

ft	85°				83°				80°				ft
	ft	lb	lb	lb	ft	lb	lb	lb	ft	lb	lb	lb	
65	73.3	341.4	470,300 b	470,300 b									65
70	70.6	339.6	468,100 b	468,100 b									70
75	67.9	337.5	464,400 b	464,400 b	72.1	339.7	466,100 b	472,900 b					75
80	65.1	335.1	449,400 b	453,200 b	69.4	337.7	431,800 b	472,900 b					80
85	62.3	332.3	418,200	424,500	66.7	335.5	401,800 b	467,600 b					85
90	59.4	329.3	390,600	398,000	63.9	333.0	375,300	456,600					90
95	56.4	325.9	366,100	374,800	61.0	330.1	351,600	445,800	67.5	334.3	330,000	473,800	95
100	53.2	322.0	344,200	354,400	58.0	326.9	330,500	422,700	64.7	331.9	310,000	466,500	100
105	49.9	317.8	324,300	336,700	55.0	323.3	311,400	397,700	61.9	329.1	292,100	440,400	105
110	46.5	312.9	306,400	321,300	51.8	319.3	294,100	375,800	59.0	326.0	275,700	416,800	110
115	42.8	307.5	290,000	308,100	48.4	314.7	278,300	356,900	55.9	322.5	260,900	395,400	115
120	38.8	301.2	274,900	297,100	44.8	309.6	263,900	340,400	52.8	318.7	247,300	375,900	120
125	34.3	293.9	261,000	288,400	41.0	303.8	250,600	326,500	49.5	314.3	234,800	358,100	125
130	29.3	285.1	248,200	282,200	36.8	297.1	238,300	314,900	46.0	309.4	223,200	341,700	130
135	23.2	273.8	236,100	279,500	32.2	289.2	226,800	305,800	42.2	303.8	212,500	326,600	135
140	14.4	257.0	224,600	262,800	26.7	279.5	216,100	299,800	38.2	297.4	202,500	312,700	140
145					19.8	266.5	205,900	297,900	33.7	289.9	193,200	299,700	145
150					6.7	240.8	195,700	234,800	28.5	280.9	184,400	287,600	150
155									22.2	269.2	176,000	276,300	155
160									12.7	250.8	167,800	265,500	160
165													165
170													170
175													175
180													180
185													185
190													190
195													195
200													200
205													205
210													210
215													215

# MLC650 VPC-MAX S-2

ASME B30.5

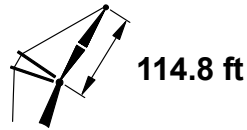
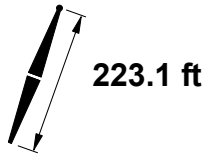
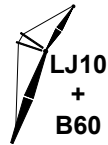

ft	75°				70°				65°				ft
	ft	°	ft	lb	ft	°	ft	lb	ft	°	ft	lb	
65													65
70													70
75													75
80													80
85													85
90													90
95													95
100													100
105													105
110													110
115													115
120	64.2	326.9	219,700	354,900									120
125	61.3	324.0	208,500	338,000									125
130	58.4	320.9	198,100	322,500									130
135	55.3	317.3	188,500	308,200									135
140	52.1	313.3	179,600	295,000									140
145	48.8	308.9	171,200	282,800									145
150	45.2	303.8	163,500	271,400	57.5	313.7	142,400	255,400					150
155	41.4	298.1	156,100	260,700	54.4	310.0	135,900	245,300					155
160	37.3	291.5	149,200	250,700	51.1	305.9	129,800	235,900					160
165	32.7	283.7	142,700	241,400	47.7	301.3	124,100	227,100					165
170	27.4	274.3	136,500	232,500	44.1	296.1	118,600	218,800					170
175	20.6	261.8	130,400	224,200	40.3	290.1	113,400	211,000	53.0	300.7	96,200	198,000	175
180	9.4	239.7	124,200	216,000	36.0	283.2	108,500	203,600	49.8	296.3	91,900	191,000	180
185					31.2	275.0	103,800	196,600	46.3	291.5	87,800	184,400	185
190					25.6	264.9	99,200	189,900	42.6	286.0	83,900	178,200	190
195					18.2	250.9	94,700	183,500	38.5	279.6	80,200	172,300	195
200									34.1	272.3	76,600	166,700	200
205									29.0	263.4	73,100	161,300	205
210									22.8	252.0	69,600	156,100	210
215									13.8	234.6	66,000	151,000	215

# MLC650 VPC-MAX S-2

ASME B30.5



661,300 lb

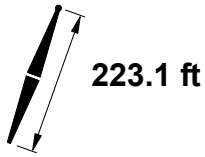

223.1 ft

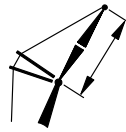

124.7 ft

ft	85°				83°				80°				ft
	ft	lb	lb	lb	ft	lb	lb	lb	ft	lb	lb	lb	
65	74.6	351.8	437,500 b	437,500 b									65
70	72.2	350.1	437,000 b	437,000 b									70
75	69.7	348.2	434,700 b	434,700 b									75
80	67.2	346.0	431,100 b	431,100 b	71.1	348.3	431,900 b	440,000 b					80
85	64.7	343.5	418,500	423,400	68.6	346.3	401,900 b	439,700 b					85
90	62.1	340.8	391,000	396,800	66.1	344.0	375,400	437,800					90
95	59.4	337.8	366,500	373,300	63.5	341.4	351,900	430,900	69.4	345.1	330,100	438,000	95
100	56.6	334.4	344,600	352,600	60.9	338.6	330,800	421,300	66.9	342.8	310,100	438,000	100
105	53.7	330.6	324,800	334,300	58.1	335.4	311,700	398,600	64.3	340.4	292,200	438,000	105
110	50.8	326.5	306,900	318,200	55.3	331.8	294,500	376,000	61.7	337.6	275,900	416,300	110
115	47.6	321.8	290,600	304,000	52.4	327.9	278,800	356,200	59.0	334.5	261,100	395,000	115
120	44.3	316.6	275,700	291,800	49.4	323.5	264,400	338,800	56.2	331.1	247,600	375,600	120
125	40.8	310.8	261,900	281,300	46.2	318.7	251,200	323,600	53.3	327.3	235,100	357,800	125
130	36.9	304.1	249,200	272,600	42.7	313.2	239,000	310,400	50.3	323.0	223,700	341,600	130
135	32.7	296.3	237,400	265,800	39.1	307.0	227,700	299,200	47.2	318.3	213,000	326,500	135
140	27.8	287.0	226,400	261,300	35.1	299.9	217,200	290,000	43.8	313.1	203,100	312,700	140
145	21.9	275.2	216,000	259,900	30.6	291.5	207,300	282,900	40.3	307.1	193,900	299,800	145
150	13.4	257.3	206,000	243,600	25.4	281.2	198,000	278,500	36.4	300.3	185,300	287,800	150
155					18.6	267.4	189,100	277,900	32.1	292.3	177,200	276,600	155
160					5.2	238.6	180,000	214,600	27.1	282.8	169,500	266,000	160
165									21.0	270.4	162,100	256,200	165
170									11.6	250.7	154,800	246,700	170
175													175
180													180
185													185
190													190
195													195
200													200
205													205
210													210
215													215
220													220

# MLC650 VPC-MAX S-2

ASME B30.5

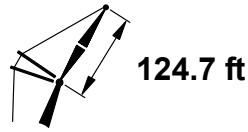
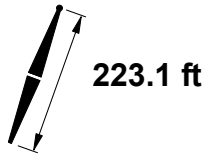
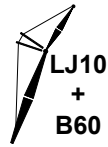

ft	75°				70°				65°				ft
	ft	°	ft	lb	ft	°	ft	lb	ft	°	ft	lb	
65													65
70													70
75													75
80													80
85													85
90													90
95													95
100													100
105													105
110													110
115													115
120													120
125	63.8	335.3	208,500	337,600									125
130	61.2	332.5	198,200	322,200									130
135	58.4	329.3	188,700	308,000									135
140	55.6	325.8	179,800	294,800									140
145	52.7	322.0	171,500	282,600									145
150	49.7	317.6	163,800	271,300									150
155	46.5	312.8	156,500	260,700	57.6	322.2	136,000	245,100					155
160	43.1	307.4	149,700	250,800	54.8	318.6	130,000	235,800					160
165	39.5	301.3	143,300	241,500	51.9	314.6	124,300	227,000					165
170	35.5	294.3	137,200	232,800	48.8	310.1	118,900	218,800					170
175	31.1	286.1	131,500	224,500	45.5	305.2	113,800	211,000					175
180	26.0	276.0	125,900	216,700	42.1	299.6	109,000	203,700	53.6	309.3	92,000	190,900	180
185	19.5	262.8	120,500	209,300	38.4	293.2	104,400	196,800	50.6	305.1	88,000	184,400	185
190	8.2	238.9	114,900	202,000	34.3	285.9	100,000	190,200	47.5	300.4	84,200	178,200	190
195					29.7	277.2	95,700	183,900	44.1	295.2	80,500	172,400	195
200					24.2	266.4	91,600	178,000	40.6	289.3	77,000	166,800	200
205					17.0	251.6	87,500	172,200	36.7	282.6	73,600	161,500	205
210									32.5	274.7	70,400	156,400	210
215									27.6	265.3	67,200	151,500	215
220									21.6	253.3	64,000	146,800	220

# MLC650 VPC-MAX S-2

ASME B30.5

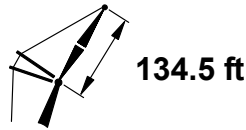
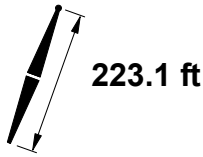

ft	85°				83°				80°				ft
	ft	lb	lb	lb	ft	lb	lb	lb	ft	lb	lb	lb	
70	73.6	360.5	406,300 b	406,300 b									70
75	71.3	358.7	405,300 b	405,300 b									75
80	69.0	356.7	403,000	403,000	72.6	358.8	407,500 b	407,500 b					80
85	66.7	354.5	399,900	399,900	70.3	356.9	399,200	407,500					85
90	64.3	352.0	388,500	394,400	68.0	354.8	372,700	407,500					90
95	61.9	349.3	364,100	370,800	65.6	352.5	349,200	406,100					95
100	59.4	346.3	342,200	350,000	63.2	349.9	328,200	403,500	68.7	353.6	307,200	406,500	100
105	56.8	342.9	322,500	331,400	60.8	347.0	309,200	396,600	66.4	351.4	289,300	406,500	105
110	54.2	339.2	304,700	315,000	58.2	343.9	292,000	375,600	64.0	348.8	273,100	406,500	110
115	51.4	335.2	288,400	300,300	55.7	340.4	276,300	355,100	61.5	346.1	258,300	392,400	115
120	48.6	330.7	273,500	287,400	53.0	336.5	262,000	337,100	59.0	343.0	244,800	373,100	120
125	45.6	325.7	259,800	276,000	50.2	332.3	248,900	321,100	56.5	339.6	232,400	355,400	125
130	42.4	320.2	247,200	266,100	47.3	327.6	236,700	307,100	53.8	335.9	221,000	339,200	130
135	39.0	314.0	235,500	257,600	44.2	322.4	225,500	294,800	51.1	331.7	210,500	324,200	135
140	35.3	306.9	224,700	250,700	40.9	316.6	215,100	284,000	48.2	327.2	200,600	310,400	140
145	31.2	298.7	214,500	245,500	37.4	310.0	205,300	275,000	45.2	322.2	191,500	297,600	145
150	26.5	288.9	204,900	241,100	33.5	302.4	196,200	267,600	42.0	316.5	183,000	285,600	150
155	20.8	276.4	195,900	237,100	29.2	293.6	187,600	262,100	38.5	310.2	174,900	274,500	155
160	12.4	257.4	187,000	224,200	24.1	282.8	179,500	257,800	34.8	303.0	167,400	264,100	160
165					17.6	268.2	171,700	254,200	30.6	294.6	160,300	254,300	165
170					2.9	234.3	163,300	190,800	25.8	284.5	153,500	245,100	170
175									19.9	271.5	146,900	236,400	175
180									10.7	250.5	140,400	228,000	180
185													185
190													190
195													195
200													200
205													205
210													210
215													215
220													220
230													230

# MLC650 VPC-MAX S-2

ASME B30.5

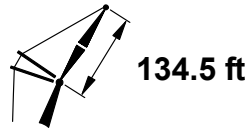
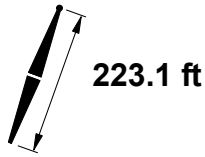

ft	75°				70°				65°				ft
	ft	°	ft	lb	ft	°	ft	lb	ft	°	ft	lb	
70													70
75													75
80													80
85													85
90													90
95													95
100													100
105													105
110													110
115													115
120													120
125													125
130	63.5	343.8	195,100	319,500									130
135	61.0	341.0	185,600	305,300									135
140	58.5	337.8	176,700	292,200									140
145	55.9	334.4	168,500	280,100									145
150	53.3	330.6	160,900	268,800									150
155	50.5	326.4	153,700	258,300									155
160	47.6	321.7	147,000	248,400	57.8	330.7	126,700	233,100					160
165	44.5	316.6	140,600	239,200	55.2	327.2	121,100	224,400					165
170	41.3	310.8	134,700	230,500	52.5	323.2	115,800	216,200					170
175	37.8	304.3	129,000	222,400	49.6	318.9	110,800	208,500					175
180	34.0	296.9	123,600	214,700	46.7	314.1	106,000	201,300					180
185	29.7	288.3	118,400	207,400	43.6	308.8	101,500	194,400	54.0	317.8	84,700	181,800	185
190	24.7	277.7	113,500	200,400	40.3	302.9	97,200	187,900	51.3	313.8	81,000	175,600	190
195	18.4	263.7	108,600	193,800	36.7	296.1	93,100	181,700	48.4	309.3	77,400	169,800	195
200	7.2	237.8	103,500	187,200	32.8	288.4	89,100	175,900	45.4	304.3	73,900	164,300	200
205					28.3	279.2	85,300	170,300	42.2	298.7	70,600	159,100	205
210					23.1	267.9	81,600	164,900	38.8	292.4	67,500	154,100	210
215					16.1	252.2	77,900	159,700	35.1	285.3	64,400	149,300	215
220									31.0	277.1	61,500	144,700	220
230									20.5	254.4	55,700	136,000	230

# MLC650 VPC-MAX S-2

ASME B30.5



661,300 lb

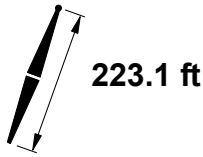

223.1 ft

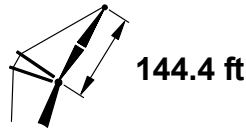

144.4 ft

ft	85°				83°				80°				ft
	ft	lb	lb	lb	ft	lb	lb	lb	ft	lb	lb	lb	
70	74.7	370.8	376,700 b	376,700 b									70
75	72.6	369.2	376,700 b	376,700 b									75
80	70.5	367.4	375,500	375,500									80
85	68.4	365.3	373,500	373,500	71.7	367.5	378,100	378,100					85
90	66.2	363.0	370,500	370,500	69.6	365.5	370,800	378,100					90
95	64.0	360.5	362,400	367,200	67.4	363.4	347,300	378,000					95
100	61.7	357.8	340,600	349,500	65.2	361.0	326,300	376,500					100
105	59.4	354.7	320,900	330,800	63.0	358.4	307,400	374,400	68.1	362.2	287,300	376,900	105
110	57.0	351.4	303,000	314,000	60.7	355.5	290,200	371,700	65.9	359.9	271,100	376,900	110
115	54.6	347.8	286,800	298,900	58.3	352.3	274,600	356,600	63.7	357.3	256,400	376,900	115
120	52.0	343.8	272,000	285,500	55.9	348.9	260,300	338,000	61.4	354.5	242,900	371,200	120
125	49.4	339.5	258,300	273,400	53.4	345.1	247,200	321,300	59.1	351.5	230,600	353,500	125
130	46.7	334.7	245,800	262,800	50.9	341.0	235,100	306,600	56.7	348.1	219,200	337,400	130
135	43.8	329.4	234,200	253,300	48.2	336.4	223,900	293,300	54.2	344.4	208,700	322,500	135
140	40.7	323.5	223,300	245,200	45.4	331.4	213,600	281,700	51.7	340.4	198,900	308,700	140
145	37.4	317.0	213,300	238,200	42.4	325.9	203,900	271,500	49.0	336.0	189,800	295,900	145
150	33.9	309.5	203,900	230,900	39.3	319.8	194,900	262,600	46.3	331.2	181,300	284,000	150
155	29.9	300.9	195,000	223,500	35.9	312.8	186,400	255,100	43.4	325.8	173,400	273,000	155
160	25.4	290.6	186,600	217,900	32.2	304.9	178,400	247,200	40.3	319.9	165,900	262,600	160
165	19.8	277.5	178,700	214,800	28.0	295.6	170,900	239,500	37.0	313.2	158,900	252,900	165
170	11.6	257.3	170,800	202,900	23.1	284.3	163,700	233,700	33.4	305.6	152,200	243,700	170
175					16.7	269.0	156,700	231,000	29.3	296.8	145,900	235,100	175
180									24.7	286.2	139,900	227,000	180
185									18.9	272.5	134,000	219,200	185
190									9.8	250.1	128,100	211,800	190
195													195
200													200
205													205
210													210
215													215
220													220
230													230
240													240



# MLC650 VPC-MAX S-2

ASME B30.5

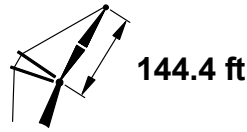
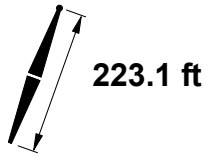

ft	75°				70°				65°				ft
	ft	°	ft	lb	ft	°	ft	lb	ft	°	ft	lb	
70													70
75													75
80													80
85													85
90													90
95													95
100													100
105													105
110													110
115													115
120													120
125													125
130													130
135	63.2	352.3	183,500	303,400									135
140	60.9	349.4	174,700	290,400									140
145	58.6	346.3	166,500	278,300									145
150	56.2	342.9	158,900	267,000									150
155	53.7	339.2	151,800	256,600									155
160	51.1	335.1	145,100	246,800									160
165	48.5	330.6	138,800	237,600	57.9	339.2	119,000	222,600					165
170	45.7	325.6	132,900	229,000	55.5	335.7	113,700	214,500					170
175	42.7	320.2	127,300	220,800	53.0	331.8	108,800	206,800					175
180	39.6	314.1	122,000	213,200	50.4	327.6	104,000	199,600					180
185	36.3	307.2	116,900	205,900	47.7	323.0	99,600	192,800					185
190	32.6	299.4	112,100	199,100	44.8	317.9	95,300	186,300	54.4	326.4	78,800	173,900	190
195	28.5	290.3	107,500	192,500	41.8	312.3	91,300	180,200	51.9	322.4	75,300	168,100	195
200	23.6	279.2	103,000	186,300	38.7	306.0	87,400	174,400	49.3	318.0	71,900	162,700	200
205	17.5	264.6	98,600	180,300	35.2	298.9	83,700	168,800	46.5	313.2	68,700	157,500	205
210	6.0	236.2	93,900	174,400	31.4	290.8	80,100	163,500	43.6	307.9	65,600	152,500	210
215					27.1	281.2	76,700	158,500	40.5	302.0	62,600	147,800	215
220					22.0	269.3	73,300	153,600	37.3	295.4	59,700	143,200	220
230									29.7	279.3	54,300	134,700	230
240									19.5	255.5	49,000	126,800	240

# MLC650 VPC-MAX S-2

ASME B30.5

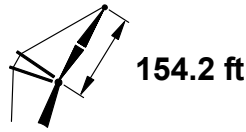
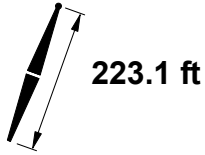

ft	85°				83°				80°				ft
	ft	lb	lb	lb	ft	lb	lb	lb	ft	lb	lb	lb	
75	73.8	379.6	350,700	350,700									75
80	71.8	377.9	350,300	350,300									80
85	69.8	376.0	349,100	349,100	72.9	377.9	350,700	350,700					85
90	67.8	373.9	347,200	347,200	70.9	376.1	350,700	350,700					90
95	65.8	371.5	344,800	344,800	68.9	374.1	344,600	350,700					95
100	63.7	369.0	338,100	341,400	66.9	371.9	323,700	350,700					100
105	61.6	366.2	318,500	328,600	64.8	369.5	304,800	350,200	69.6	372.9	284,300	347,700	105
110	59.4	363.2	300,700	311,700	62.7	366.9	287,600	348,300	67.5	370.7	268,200	347,700	110
115	57.2	359.9	284,500	296,500	60.6	364.0	272,100	346,100	65.5	368.4	253,500	347,700	115
120	54.9	356.3	269,700	282,900	58.4	360.8	257,800	335,500	63.4	365.8	240,100	347,700	120
125	52.5	352.4	256,100	270,500	56.2	357.4	244,700	320,600	61.3	363.0	227,800	347,700	125
130	50.1	348.2	243,600	259,400	53.8	353.7	232,700	305,300	59.1	359.9	216,500	335,000	130
135	47.6	343.6	232,000	249,600	51.5	349.6	221,600	291,700	56.9	356.6	206,000	320,100	135
140	44.9	338.5	221,200	240,800	49.0	345.2	211,200	279,500	54.6	353.0	196,300	306,400	140
145	42.1	332.9	211,200	232,900	46.4	340.4	201,600	268,600	52.2	349.0	187,200	293,700	145
150	39.2	326.7	201,900	223,600	43.7	335.1	192,600	258,900	49.8	344.8	178,800	281,800	150
155	36.0	319.8	193,100	215,300	40.8	329.3	184,200	250,000	47.2	340.1	170,900	270,800	155
160	32.6	312.0	184,900	208,000	37.8	322.8	176,300	240,200	44.5	334.9	163,500	260,500	160
165	28.8	303.0	177,100	202,000	34.5	315.5	168,900	231,300	41.7	329.3	156,500	250,800	165
170	24.3	292.3	169,700	197,400	30.9	307.2	161,800	223,500	38.8	323.0	149,900	241,700	170
175	18.9	278.5	162,600	195,100	26.9	297.5	155,200	217,000	35.6	316.0	143,700	233,200	175
180	10.8	257.2	155,600	187,500	22.1	285.6	148,800	212,300	32.1	308.1	137,800	225,100	180
185					15.8	269.6	142,500	210,400	28.2	298.8	132,200	217,400	185
190									23.7	287.8	126,800	210,200	190
195									18.0	273.4	121,500	203,200	195
200									9.0	249.5	116,200	196,500	200
205													205
210													210
215													215
220													220
230													230
240													240
250													250

# MLC650 VPC-MAX S-2

ASME B30.5

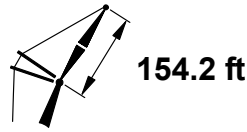
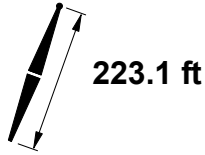
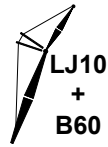

ft	75°				70°				65°				ft
	ft	°	ft	lb	ft	°	ft	lb	ft	°	ft	lb	
75													75
80													80
85													85
90													90
95													95
100													100
105													105
110													110
115													115
120													120
125													125
130													130
135													135
140	63.0	360.8	171,600	287,800									140
145	60.8	357.9	163,500	275,700									145
150	58.6	354.8	155,900	264,500									150
155	56.4	351.4	148,900	254,100									155
160	54.1	347.7	142,200	244,400									160
165	51.7	343.7	136,000	235,200									165
170	49.2	339.3	130,100	226,600	58.0	347.7	110,500	211,900					170
175	46.7	334.6	124,600	218,600	55.7	344.2	105,600	204,300					175
180	44.0	329.3	119,300	211,000	53.4	340.4	101,000	197,100					180
185	41.2	323.6	114,300	203,800	51.0	336.3	96,600	190,300					185
190	38.1	317.2	109,600	197,000	48.5	331.8	92,400	183,900					190
195	34.9	310.0	105,000	190,500	45.9	326.9	88,400	177,800	54.8	335.0	72,000	165,600	195
200	31.3	301.8	100,700	184,300	43.2	321.6	84,600	172,100	52.4	331.0	68,700	160,100	200
205	27.3	292.3	96,500	178,500	40.3	315.6	80,900	166,600	50.0	326.8	65,500	155,000	205
210	22.6	280.7	92,500	172,900	37.2	309.0	77,500	161,300	47.4	322.1	62,500	150,000	210
215	16.6	265.3	88,500	167,500	33.9	301.6	74,100	156,300	44.8	317.0	59,500	145,400	215
220	4.9	234.1	84,100	162,100	30.2	293.0	70,900	151,600	42.0	311.4	56,700	140,900	220
230					21.1	270.6	64,600	142,500	35.9	298.3	51,500	132,500	230
240									28.5	281.3	46,500	124,700	240
250									18.6	256.5	41,600	117,500	250

# MLC650 VPC-MAX S-2

ASME B30.5



661,300 lb

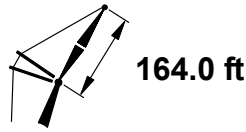
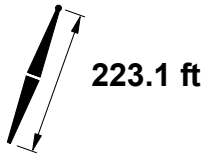

ft	85°				83°				80°				ft
	ft	lb	lb	lb	ft	lb	lb	lb	ft	lb	lb	lb	
75	74.8	389.9	326,400	326,400									75
80	73.0	388.3	326,400	326,400									80
85	71.1	386.5	326,100	326,100									85
90	69.2	384.6	324,900	324,900	72.1	386.6	326,700	326,700					90
95	67.3	382.4	323,100	323,100	70.3	384.7	326,700	326,700					95
100	65.4	380.1	320,500	320,500	68.4	382.7	322,900	326,700					100
105	63.4	377.5	317,100	317,100	66.5	380.4	304,100	326,700					105
110	61.4	374.7	300,200	305,300	64.5	378.0	287,000	325,700	69.0	381.4	267,300	323,400	110
115	59.4	371.7	284,000	293,400	62.5	375.3	271,400	324,100	67.1	379.3	252,700	323,400	115
120	57.3	368.4	269,200	280,900	60.5	372.5	257,200	322,200	65.1	376.9	239,300	323,400	120
125	55.2	364.9	255,700	268,400	58.5	369.3	244,200	312,300	63.2	374.3	227,000	323,400	125
130	53.0	361.0	243,200	257,000	56.4	365.9	232,100	300,400	61.2	371.5	215,700	323,400	130
135	50.7	356.9	231,600	246,700	54.2	362.3	221,000	288,700	59.1	368.4	205,300	319,200	135
140	48.4	352.4	220,900	237,000	52.0	358.3	210,700	277,100	57.0	365.1	195,600	305,500	140
145	45.9	347.5	210,900	227,100	49.7	354.0	201,100	265,800	54.9	361.5	186,600	292,800	145
150	43.4	342.1	201,600	217,800	47.3	349.3	192,200	254,800	52.7	357.7	178,200	281,000	150
155	40.7	336.3	192,900	209,200	44.8	344.2	183,800	244,400	50.4	353.5	170,300	270,000	155
160	37.8	329.8	184,700	201,300	42.2	338.6	176,000	234,500	48.0	348.9	162,900	259,800	160
165	34.7	322.6	177,000	194,200	39.4	332.5	168,600	225,300	45.6	344.0	156,000	250,100	165
170	31.4	314.4	169,700	188,000	36.5	325.7	161,600	216,800	43.0	338.5	149,500	241,100	170
175	27.7	305.0	162,800	182,900	33.3	318.1	155,100	209,100	40.3	332.6	143,300	232,600	175
180	23.4	293.8	156,300	179,100	29.8	309.5	148,800	202,500	37.4	326.0	137,500	224,500	180
185	18.1	279.4	149,900	177,400	25.8	299.3	142,800	196,900	34.3	318.7	131,900	216,900	185
190	10.0	256.9	143,600	174,700	21.2	286.9	137,100	193,000	30.9	310.4	126,600	209,700	190
195					15.1	270.1	131,500	191,600	27.1	300.8	121,600	202,900	195
200									22.7	289.2	116,700	196,400	200
205									17.2	274.2	112,000	190,200	205
210									8.2	248.8	107,100	180,400	210
215													215
220													220
230													230
240													240
250													250
260													260

# MLC650 VPC-MAX S-2

ASME B30.5

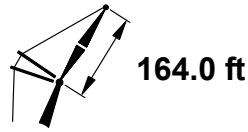
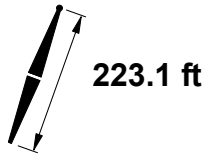
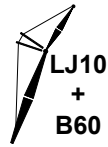

ft	75°				70°				65°				ft
	ft	°	ft	lb	ft	°	ft	lb	ft	°	ft	lb	
75													75
80													80
85													85
90													90
95													95
100													100
105													105
110													110
115													115
120													120
125													125
130													130
135													135
140	64.7	371.9	170,700	286,800									140
145	62.8	369.2	162,600	274,800									145
150	60.8	366.4	155,000	263,600									150
155	58.7	363.3	148,000	253,200									155
160	56.6	359.9	141,400	243,500									160
165	54.4	356.3	135,200	234,400									165
170	52.2	352.3	129,400	225,900									170
175	49.9	348.1	123,800	217,800	58.1	356.2	104,700	203,400					175
180	47.5	343.4	118,600	210,200	56.0	352.7	100,000	196,300					180
185	45.1	338.4	113,700	203,100	53.8	349.0	95,700	189,500					185
190	42.5	332.9	109,000	196,300	51.5	345.0	91,500	183,100					190
195	39.7	326.8	104,500	189,900	49.2	340.6	87,600	177,100					195
200	36.8	320.1	100,300	183,800	46.8	335.9	83,800	171,300					200
205	33.6	312.6	96,200	178,000	44.3	330.7	80,200	165,900	52.9	339.7	64,500	154,100	205
210	30.2	304.1	92,300	172,400	41.7	325.0	76,800	160,700	50.6	335.5	61,500	149,200	210
215	26.3	294.1	88,500	167,100	38.9	318.8	73,500	155,700	48.2	331.0	58,700	144,600	215
220	21.7	282.1	84,800	162,000	35.9	311.9	70,300	151,000	45.8	326.0	55,900	140,100	220
230	3.4	230.6	77,000	152,200	29.1	295.2	64,300	142,100	40.5	314.8	50,700	131,800	230
240					20.2	271.7	58,600	133,900	34.6	301.0	45,900	124,100	240
250									27.5	283.3	41,300	117,100	250
260									17.8	257.4	36,900	110,400	260

# MLC650 VPC-MAX S-2

ASME B30.5

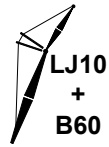

661,300 lb

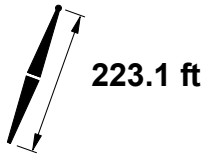

223.1 ft



173.9 ft

ft	85°				83°				80°				ft
	ft	lb	lb	lb	ft	lb	lb	lb	ft	lb	lb	lb	
80	74.0	398.6	304,500	304,500									80
85	72.2	397.0	304,400	304,400									85
90	70.5	395.1	303,800	303,800									90
95	68.7	393.1	302,600	302,600	71.4	395.2	304,500	304,500					95
100	66.9	390.9	301,000	301,000	69.7	393.3	304,500	304,500					100
105	65.1	388.6	298,600	298,600	67.9	391.2	301,400	304,500					105
110	63.2	386.0	293,800	293,800	66.1	389.0	284,400	304,400					110
115	61.3	383.2	281,600	283,200	64.2	386.5	268,800	303,400	68.4	390.0	249,800	301,100	115
120	59.4	380.2	266,900	272,600	62.4	383.8	254,700	302,100	66.6	387.8	236,500	301,100	120
125	57.4	376.9	253,300	261,900	60.5	380.9	241,600	300,500	64.8	385.4	224,200	301,100	125
130	55.4	373.4	240,900	251,500	58.5	377.8	229,700	290,900	63.0	382.8	213,000	301,100	130
135	53.4	369.6	229,300	241,200	56.5	374.4	218,600	280,300	61.1	380.0	202,600	301,100	135
140	51.2	365.6	218,600	231,300	54.5	370.8	208,300	269,800	59.1	376.9	192,900	301,100	140
145	49.1	361.2	208,700	221,800	52.4	366.9	198,800	259,300	57.2	373.6	183,900	290,600	145
150	46.8	356.4	199,400	212,800	50.3	362.7	189,800	249,100	55.2	370.1	175,600	278,800	150
155	44.4	351.3	190,800	204,300	48.0	358.1	181,500	239,200	53.1	366.3	167,700	267,800	155
160	41.9	345.6	182,600	196,300	45.7	353.2	173,700	229,700	50.9	362.1	160,400	257,600	160
165	39.3	339.5	175,000	189,000	43.3	347.9	166,400	220,600	48.7	357.7	153,500	248,000	165
170	36.6	332.7	167,800	182,200	40.8	342.0	159,500	212,100	46.5	352.9	147,000	239,000	170
175	33.6	325.2	160,900	176,200	38.1	335.6	152,900	204,200	44.1	347.7	140,900	230,500	175
180	30.3	316.7	154,500	171,000	35.3	328.5	146,700	196,900	41.6	342.0	135,100	222,500	180
185	26.7	307.0	148,300	166,700	32.2	320.6	140,900	190,300	39.0	335.8	129,600	214,900	185
190	22.5	295.3	142,400	163,600	28.8	311.6	135,300	184,600	36.2	328.9	124,400	207,800	190
195	17.3	280.3	136,700	162,400	24.9	301.1	129,900	179,900	33.2	321.3	119,400	201,000	195
200	9.3	256.5	131,000	159,200	20.4	288.2	124,700	176,700	29.9	312.6	114,700	194,600	200
205					14.3	270.6	119,600	175,800	26.2	302.6	110,100	188,400	205
210									21.9	290.6	105,700	182,600	210
215									16.5	275.0	101,300	176,900	215
220									7.4	247.9	96,800	164,100	220
230													230
240													240
250													250
260													260
270													270

# MLC650 VPC-MAX S-2

ASME B30.5

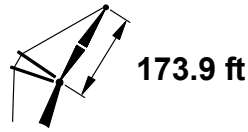
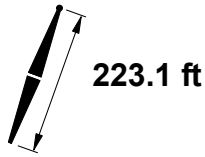

ft	75°				70°				65°				ft
	ft	lb	lb	lb	ft	lb	lb	lb	ft	lb	lb	lb	
80													80
85													85
90													90
95													95
100													100
105													105
110													110
115													115
120													120
125													125
130													130
135													135
140													140
145	64.4	380.4	159,500	272,200									145
150	62.6	377.7	152,000	261,100									150
155	60.7	374.9	145,000	250,800									155
160	58.7	371.8	138,400	241,100									160
165	56.8	368.4	132,300	232,000									165
170	54.7	364.8	126,500	223,500									170
175	52.7	361.0	121,000	215,500									175
180	50.5	356.8	115,800	208,000	58.2	364.7	96,900	193,800					180
185	48.3	352.3	110,900	200,800	56.2	361.3	92,600	187,000					185
190	46.0	347.4	106,300	194,100	54.1	357.6	88,500	180,700					190
195	43.6	342.1	101,900	187,700	52.0	353.6	84,600	174,700					195
200	41.1	336.3	97,700	181,600	49.9	349.4	80,800	169,000					200
205	38.4	330.0	93,600	175,900	47.6	344.7	77,300	163,500					205
210	35.6	323.0	89,800	170,400	45.3	339.7	73,900	158,400	53.3	348.3	58,300	146,700	210
215	32.5	315.1	86,100	165,100	42.9	334.3	70,700	153,500	51.1	344.2	55,500	142,100	215
220	29.2	306.3	82,500	160,100	40.3	328.4	67,600	148,800	48.9	339.8	52,800	137,700	220
230	20.9	283.3	75,700	150,700	34.7	314.6	61,700	140,000	44.3	329.8	47,700	129,400	230
240					28.1	297.2	56,200	131,900	39.2	318.0	43,000	121,900	240
250					19.4	272.8	51,000	124,300	33.4	303.6	38,600	114,900	250
260									26.5	285.2	34,400	108,400	260
270									17.0	258.2	30,200	102,200	270

# MLC650 VPC-MAX S-2

ASME B30.5

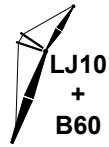

661,300 lb

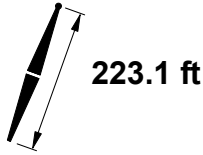

223.1 ft



193.6 ft

ft	85°				83°				80°				ft
	ft	lb	lb	lb	ft	lb	lb	lb	ft	lb	lb	lb	
85	74.1	417.7	264,000	264,000									85
90	72.5	416.1	264,000	264,000									90
95	71.0	414.3	263,700	263,700									95
100	69.4	412.4	262,900	262,900	71.8	414.4	263,200	263,200					100
105	67.8	410.3	261,600	261,600	70.3	412.5	263,200	263,200					105
110	66.2	408.0	260,100	260,100	68.7	410.5	263,200	263,200					110
115	64.5	405.6	258,300	258,300	67.1	408.3	263,200	263,200					115
120	62.8	402.9	254,400	254,400	65.4	406.0	251,300	263,200	69.2	409.2	232,700	258,500	120
125	61.1	400.1	245,900	245,900	63.8	403.5	238,400	262,600	67.6	407.1	220,500	258,500	125
130	59.4	397.1	237,400	237,400	62.1	400.8	226,400	261,600	65.9	404.8	209,300	258,500	130
135	57.7	393.9	226,400	228,800	60.4	397.9	215,400	260,300	64.3	402.4	198,900	258,500	135
140	55.9	390.5	215,800	220,300	58.6	394.8	205,100	254,300	62.6	399.7	189,300	258,500	140
145	54.0	386.8	205,900	212,000	56.9	391.5	195,600	245,800	60.9	396.9	180,400	258,500	145
150	52.1	382.8	196,600	203,900	55.0	387.9	186,800	237,400	59.2	393.9	172,100	258,500	150
155	50.2	378.6	188,000	196,100	53.2	384.1	178,500	228,900	57.4	390.6	164,300	258,500	155
160	48.2	374.1	179,900	188,500	51.3	380.0	170,700	220,500	55.6	387.1	157,000	254,600	160
165	46.1	369.2	172,300	181,300	49.3	375.7	163,500	212,400	53.8	383.4	150,200	245,000	165
170	44.0	364.0	165,200	174,500	47.3	371.0	156,600	204,400	51.9	379.4	143,800	236,100	170
175	41.8	358.4	158,500	168,100	45.2	366.0	150,100	196,800	49.9	375.2	137,700	227,700	175
180	39.4	352.3	152,100	162,100	43.0	360.6	144,000	189,500	47.9	370.6	132,000	219,700	180
185	37.0	345.6	146,000	156,600	40.7	354.8	138,200	182,500	45.9	365.7	126,500	212,200	185
190	34.4	338.3	140,300	151,500	38.3	348.4	132,700	176,100	43.7	360.4	121,400	205,100	190
195	31.5	330.2	134,800	147,100	35.8	341.5	127,500	170,000	41.5	354.7	116,500	198,400	195
200	28.4	321.0	129,600	143,300	33.1	333.8	122,500	164,500	39.1	348.6	111,900	192,000	200
205	25.0	310.5	124,600	140,100	30.2	325.3	117,800	159,500	36.6	341.8	107,400	185,900	205
210	21.0	297.9	119,800	138,000	26.9	315.6	113,200	155,300	34.0	334.4	103,200	180,200	210
215	16.0	281.7	115,100	137,400	23.3	304.2	108,800	151,900	31.1	326.2	99,100	174,700	215
220	8.0	255.2	110,300	133,300	18.9	290.3	104,500	149,600	28.0	316.8	95,200	169,400	220
230									20.4	293.1	87,700	159,500	230
240									5.9	245.3	80,200	137,400	240
250													250
260													260
270													270
280													280
290													290



# MLC650 VPC-MAX S-2

ASME B30.5

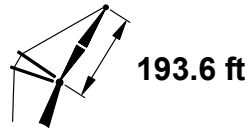
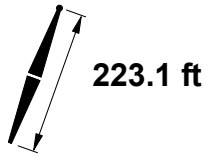

ft	75°				70°				65°				ft
	ft	°	ft	lb	ft	°	ft	lb	ft	°	ft	lb	
85													85
90													90
95													95
100													100
105													105
110													110
115													115
120													120
125													125
130													130
135													135
140													140
145													145
150													150
155	63.9	397.4	141,000	246,200									155
160	62.3	394.7	134,500	237,700									160
165	60.6	391.8	128,400	228,700									165
170	58.8	388.7	122,600	220,200									170
175	57.0	385.4	117,200	212,300									175
180	55.2	381.9	112,100	204,800									180
185	53.4	378.1	107,300	197,700									185
190	51.5	374.1	102,700	191,100	58.3	381.6	84,300	177,300					190
195	49.5	369.8	98,300	184,700	56.5	378.3	80,500	171,400					195
200	47.5	365.2	94,200	178,700	54.7	374.7	76,800	165,700					200
205	45.4	360.2	90,200	173,000	52.8	370.8	73,400	160,300					205
210	43.3	354.8	86,500	167,600	50.9	366.7	70,000	155,200					210
215	41.0	349.0	82,900	162,400	48.9	362.3	66,900	150,400					215
220	38.6	342.8	79,400	157,400	46.9	357.6	63,800	145,700	53.9	365.4	48,600	134,300	220
230	33.4	328.3	72,900	148,200	42.6	347.0	58,100	137,000	50.1	357.2	43,600	126,200	230
240	27.3	310.3	66,900	139,700	37.9	334.7	52,900	129,100	46.0	347.8	39,100	118,700	240
250	19.4	285.6	61,100	131,800	32.6	319.8	47,900	121,700	41.7	336.9	34,800	111,900	250
260					26.3	301.1	43,300	114,900	36.8	324.1	30,800	105,500	260
270					18.0	274.8	38,800	108,500	31.4	308.6	27,100	99,600	270
280									24.8	288.7	23,500	94,000	280
290									15.7	259.6	20,000	88,800	290

# MLC650 VPC-MAX S-2

ASME B30.5



661,300 lb

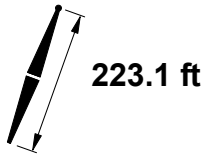

223.1 ft

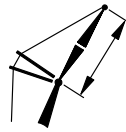

213.3 ft

ft	85°				83°				80°				ft
	ft	lb	lb	lb	ft	lb	lb	lb	ft	lb	lb	lb	
90	74.2	436.7	229,700	229,700									90
95	72.8	435.1	229,700	229,700									95
100	71.4	433.4	229,300	229,300									100
105	69.9	431.5	228,700	228,700	72.2	433.5	228,900	228,900					105
110	68.5	429.5	227,700	227,700	70.7	431.7	228,900	228,900					110
115	67.0	427.4	226,600	226,600	69.3	429.7	228,900	228,900					115
120	65.5	425.0	225,300	225,300	67.8	427.6	228,900	228,900					120
125	64.0	422.6	223,800	223,800	66.4	425.4	228,900	228,900	69.7	428.4	216,800	224,000	125
130	62.5	419.9	220,300	220,300	64.9	423.0	223,100	228,400	68.3	426.4	205,600	224,000	130
135	61.0	417.1	213,500	213,500	63.4	420.5	212,100	227,700	66.8	424.2	195,300	224,000	135
140	59.4	414.1	206,600	206,600	61.8	417.7	201,900	226,800	65.3	421.9	185,700	224,000	140
145	57.8	410.9	199,700	199,700	60.3	414.8	192,400	225,800	63.8	419.4	176,800	224,000	145
150	56.2	407.5	192,800	192,800	58.7	411.7	183,600	222,000	62.3	416.7	168,600	224,000	150
155	54.5	403.9	185,100	186,100	57.1	408.5	175,400	215,200	60.8	413.9	160,800	224,000	155
160	52.9	400.0	177,100	179,400	55.5	405.0	167,600	208,400	59.2	410.8	153,600	224,000	160
165	51.1	396.0	169,500	173,000	53.8	401.3	160,400	201,500	57.6	407.6	146,800	224,000	165
170	49.3	391.6	162,400	166,700	52.1	397.3	153,600	194,700	56.0	404.2	140,400	224,000	170
175	47.5	387.0	155,700	160,700	50.3	393.1	147,100	188,100	54.3	400.5	134,400	224,000	175
180	45.6	382.1	149,400	155,000	48.5	388.7	141,100	181,500	52.6	396.7	128,700	216,800	180
185	43.7	376.8	143,400	149,500	46.7	383.9	135,300	175,100	50.9	392.6	123,300	209,400	185
190	41.6	371.1	137,700	144,400	44.8	378.8	129,900	169,000	49.1	388.2	118,200	202,300	190
195	39.5	365.0	132,300	139,500	42.8	373.4	124,700	163,100	47.3	383.5	113,400	195,700	195
200	37.3	358.5	127,200	135,000	40.7	367.5	119,800	157,500	45.4	378.5	108,800	189,300	200
205	35.0	351.3	122,300	130,800	38.5	361.2	115,100	152,200	43.4	373.2	104,400	183,300	205
210	32.5	343.5	117,600	127,000	36.3	354.4	110,600	147,200	41.4	367.5	100,200	177,600	210
215	29.8	334.8	113,100	123,600	33.9	346.9	106,400	142,600	39.2	361.3	96,200	172,100	215
220	26.8	325.0	108,800	120,800	31.3	338.7	102,300	138,400	37.0	354.7	92,400	166,900	220
230	19.7	300.3	100,700	117,100	25.4	319.2	94,500	131,500	32.1	339.5	85,200	157,200	230
240	6.7	253.2	92,600	111,100	17.6	292.2	87,200	127,300	26.4	320.7	78,500	148,200	240
250									19.1	295.4	72,200	139,900	250
260									4.2	241.1	65,700	114,200	260
270													270
280													280
290													290
300													300
310													310

# MLC650 VPC-MAX S-2

ASME B30.5

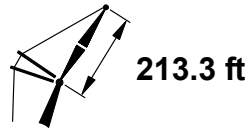
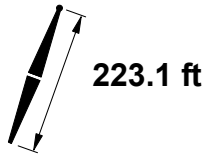

ft	75°				70°				65°				ft
	ft	ft	lb	lb	ft	ft	lb	lb	ft	ft	lb	lb	
90													90
95													95
100													100
105													105
110													110
115													115
120													120
125													125
130													130
135													135
140													140
145													145
150													150
155													155
160													160
165	63.5	414.3	124,400	213,900									165
170	62.0	411.6	118,800	213,900									170
175	60.5	408.8	113,400	209,100									175
180	58.9	405.7	108,300	201,600									180
185	57.3	402.4	103,500	194,600									185
190	55.6	399.0	99,000	188,000									190
195	54.0	395.3	94,700	181,700	60.0	401.7	76,400	168,000					195
200	52.3	391.4	90,600	175,700	58.4	398.6	72,800	162,400					200
205	50.5	387.2	86,700	170,000	56.8	395.3	69,300	157,100					205
210	48.7	382.8	83,000	164,700	55.2	391.8	66,100	152,000					210
215	46.9	378.0	79,400	159,500	53.5	388.0	63,000	147,200					215
220	45.0	373.0	76,000	154,600	51.8	384.0	60,000	142,600					220
230	40.9	361.8	69,700	145,500	48.2	375.3	54,400	134,000	54.5	382.5	39,500	122,900	230
240	36.5	348.8	63,800	137,100	44.4	365.3	49,200	126,100	51.0	374.6	35,000	115,500	240
250	31.6	333.3	58,300	129,300	40.3	353.9	44,400	118,900	47.4	365.6	30,900	108,700	250
260	25.7	314.0	53,200	122,200	35.8	340.5	40,000	112,200	43.6	355.3	27,000	102,500	260
270	18.2	287.7	48,300	115,400	30.8	324.6	35,800	106,000	39.4	343.5	23,400	96,700	270
280					24.8	304.6	31,900	100,100	34.8	329.7	20,000	91,200	280
290					16.7	276.5	28,000	94,600	29.6	313.1		86,200	290
300									23.3	291.9		81,400	300
310									14.5	260.6		76,800	310

# MLC650 VPC-MAX S-2

ASME B30.5



661,300 lb

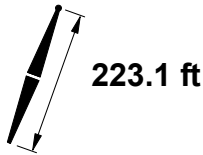

223.1 ft



232.9 ft

ft	85°				83°				80°				ft
	ft	lb	lb	lb	ft	lb	lb	lb	ft	lb	lb	lb	
95	74.3	455.8	199,900	199,900									95
100	73.0	454.2	199,700	199,700									100
105	71.7	452.5	199,300	199,300									105
110	70.4	450.7	198,800	198,800	72.4	452.5	198,400	198,400					110
115	69.1	448.7	198,100	198,100	71.1	450.8	198,400	198,400					115
120	67.8	446.7	197,200	197,200	69.8	448.9	198,400	198,400					120
125	66.4	444.4	196,300	196,300	68.5	446.9	198,400	198,400					125
130	65.0	442.1	195,300	195,300	67.1	444.7	198,400	198,400					130
135	63.7	439.5	194,200	194,200	65.8	442.5	198,000	198,000	68.9	445.6	192,700	194,000	135
140	62.3	436.9	192,600	192,600	64.4	440.0	197,500	197,500	67.6	443.5	183,200	194,000	140
145	60.9	434.0	187,100	187,100	63.0	437.4	190,200	196,900	66.2	441.3	174,300	194,000	145
150	59.4	431.0	181,600	181,600	61.6	434.7	181,400	196,200	64.9	438.9	166,100	194,000	150
155	58.0	427.9	175,900	175,900	60.2	431.8	173,200	195,400	63.5	436.4	158,400	194,000	155
160	56.5	424.5	170,400	170,400	58.8	428.7	165,500	194,500	62.1	433.7	151,200	194,000	160
165	55.0	421.0	164,900	164,900	57.3	425.4	158,300	190,000	60.7	430.8	144,400	194,000	165
170	53.4	417.2	159,400	159,400	55.8	422.0	151,500	184,500	59.2	427.8	138,000	194,000	170
175	51.9	413.2	153,900	154,000	54.3	418.4	145,100	179,000	57.8	424.6	132,100	194,000	175
180	50.3	409.0	147,600	148,800	52.7	414.5	139,100	173,400	56.3	421.2	126,400	194,000	180
185	48.6	404.6	141,600	143,700	51.2	410.5	133,300	167,900	54.8	417.6	121,100	194,000	185
190	46.9	399.9	135,900	138,900	49.5	406.1	127,900	162,400	53.2	413.8	116,000	194,000	190
195	45.2	394.9	130,600	134,200	47.9	401.6	122,800	157,100	51.7	409.8	111,200	193,700	195
200	43.4	389.5	125,500	129,700	46.2	396.7	117,900	152,000	50.0	405.6	106,600	187,400	200
205	41.5	383.9	120,600	125,500	44.4	391.6	113,300	147,000	48.4	401.1	102,300	181,400	205
210	39.6	377.8	116,000	121,400	42.6	386.1	108,800	142,200	46.7	396.4	98,100	175,700	210
215	37.6	371.3	111,600	117,700	40.7	380.3	104,600	137,500	44.9	391.3	94,200	170,300	215
220	35.5	364.3	107,400	114,200	38.7	374.0	100,600	133,100	43.1	386.0	90,400	165,100	220
230	30.8	348.3	99,400	108,100	34.5	360.0	93,000	125,100	39.3	374.1	83,300	155,400	230
240	25.4	328.7	92,100	103,400	29.7	343.3	86,000	118,200	35.2	360.4	76,800	146,600	240
250	18.5	302.4	85,200	100,600	24.0	322.6	79,400	112,900	30.5	344.2	70,700	138,400	250
260	5.4	250.3	78,200	93,200	16.5	293.9	73,200	109,900	25.0	324.3	65,000	130,800	260
270									17.9	297.4	59,600	123,800	270
280													280
290													290
300													300
310													310
320													320
330													330

# MLC650 VPC-MAX S-2

ASME B30.5

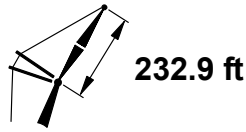
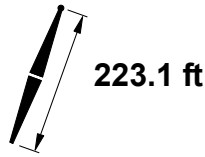

ft	75°				70°				65°				ft
	ft	°	ft	lb	ft	°	ft	lb	ft	°	ft	lb	
95													95
100													100
105													105
110													110
115													115
120													120
125													125
130													130
135													135
140													140
145													145
150													150
155													155
160													160
165													165
170	64.6	433.9	116,000	181,500									170
175	63.2	431.3	110,600	181,500									175
180	61.8	428.6	105,600	181,500									180
185	60.4	425.7	100,800	181,500									185
190	58.9	422.7	96,300	181,500									190
195	57.5	419.4	92,100	179,400									195
200	56.0	416.0	88,000	173,500									200
205	54.5	412.4	84,200	167,900	60.0	418.7	66,400	154,700					205
210	52.9	408.6	80,500	162,500	58.5	415.6	63,200	149,700					210
215	51.3	404.5	77,000	157,400	57.0	412.3	60,100	144,900					215
220	49.7	400.2	73,600	152,500	55.5	408.8	57,200	140,300					220
230	46.3	390.9	67,300	143,500	52.4	401.3	51,700	131,800					230
240	42.8	380.3	61,600	135,100	49.2	392.8	46,600	124,000	54.9	399.6	113,200		240
250	38.9	368.3	56,200	127,500	45.8	383.3	41,900	116,800	51.8	391.8	106,400		250
260	34.7	354.4	51,200	120,400	42.2	372.5	37,600	110,200	48.5	383.2	100,200		260
270	30.0	337.9	46,600	113,800	38.3	360.3	33,500	104,000	45.1	373.4	94,500		270
280	24.4	317.5	42,200	107,700	34.0	346.0	29,700	98,300	41.4	362.4	89,200		280
290	17.0	289.4	37,900	101,900	29.2	329.1	26,100	93,000	37.5	349.8	84,200		290
300					23.4	307.8	22,700	87,900	33.1	335.0	79,500		300
310					15.7	277.9		83,200	28.1	317.4	75,100		310
320									22.0	294.9	70,900		320
330									13.5	261.5	66,900		330

# MLC650 VPC-MAX S-2

ASME B30.5



661,300 lb

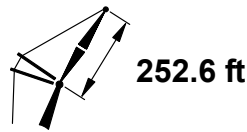
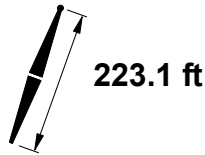

ft	85°				83°				80°				ft
	ft	lb	lb	lb	ft	lb	lb	lb	ft	lb	lb	lb	
100	74.4	474.8	172,100	172,100									100
105	73.2	473.3	172,000	172,000									105
110	72.0	471.6	171,700	171,700									110
115	70.8	469.8	171,200	171,200	72.7	471.6	170,400	170,400					115
120	69.6	467.9	170,700	170,700	71.5	469.9	170,400	170,400					120
125	68.4	465.9	170,100	170,100	70.2	468.1	170,400	170,400					125
130	67.1	463.8	169,300	169,300	69.0	466.1	170,400	170,400					130
135	65.9	461.5	168,600	168,600	67.8	464.0	170,300	170,300					135
140	64.6	459.1	167,700	167,700	66.6	461.8	170,000	170,000	69.4	464.8	166,000	166,000	140
145	63.3	456.5	166,800	166,800	65.3	459.5	169,700	169,700	68.2	462.8	166,000	166,000	145
150	62.1	453.8	165,900	165,900	64.0	457.0	169,200	169,200	66.9	460.6	162,200	166,000	150
155	60.8	451.0	163,700	163,700	62.8	454.4	168,700	168,700	65.7	458.3	154,500	166,000	155
160	59.4	448.0	159,200	159,200	61.5	451.6	162,000	168,200	64.4	455.9	147,300	166,000	160
165	58.1	444.8	154,800	154,800	60.2	448.7	154,800	167,500	63.2	453.3	140,600	166,000	165
170	56.7	441.5	150,200	150,200	58.8	445.7	148,000	166,900	61.9	450.6	134,300	166,000	170
175	55.3	438.0	145,800	145,800	57.5	442.4	141,600	166,100	60.6	447.8	128,300	166,000	175
180	53.9	434.3	141,300	141,300	56.1	439.0	135,600	162,900	59.2	444.7	122,700	166,000	180
185	52.5	430.5	136,900	136,900	54.7	435.5	129,900	158,500	57.9	441.6	117,400	166,000	185
190	51.0	426.4	132,600	132,600	53.3	431.7	124,500	154,000	56.5	438.2	112,300	166,000	190
195	49.5	422.1	127,400	128,300	51.8	427.7	119,400	149,500	55.2	434.7	107,600	166,000	195
200	48.0	417.5	122,300	124,300	50.4	423.5	114,600	145,100	53.7	431.0	103,000	166,000	200
205	46.4	412.7	117,500	120,300	48.9	419.1	110,000	140,700	52.3	427.1	98,700	166,000	205
210	44.8	407.7	112,900	116,500	47.3	414.5	105,600	136,400	50.8	423.0	94,600	166,000	210
215	43.2	402.3	108,600	112,800	45.7	409.6	101,400	132,200	49.3	418.6	90,700	163,600	215
220	41.4	396.6	104,400	109,400	44.1	404.4	97,400	128,100	47.8	414.1	86,900	159,200	220
230	37.8	384.1	96,500	102,800	40.7	393.0	89,900	120,300	44.6	404.1	79,900	150,400	230
240	33.8	369.7	89,300	97,200	36.9	380.1	83,000	113,300	41.2	393.0	73,500	141,800	240
250	29.4	352.8	82,600	92,400	32.9	365.2	76,600	106,900	37.5	380.3	67,500	133,600	250
260	24.2	332.1	76,400	88,700	28.3	347.6	70,600	101,500	33.5	365.8	62,000	125,900	260
270	17.5	304.3	70,400	86,800	22.8	325.7	65,000	97,300	29.0	348.7	56,800	119,200	270
280	4.0	246.0	64,300	76,300	15.6	295.3	59,700	95,100	23.8	327.6	51,900	113,400	280
290									16.9	299.1	47,200	106,800	290
300													300
310													310
320													320
330													330
340													340
350													350

# MLC650 VPC-MAX S-2

ASME B30.5

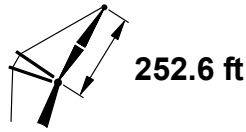
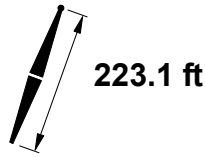

ft	75°				70°				65°				ft
	ft	°	ft	lb	ft	°	ft	lb	ft	°	ft	lb	
100													100
105													105
110													110
115													115
120													120
125													125
130													130
135													135
140													140
145													145
150													150
155													155
160													160
165													165
170													170
175													175
180	64.2	450.9	101,400	155,600									180
185	62.9	448.3	96,700	155,600									185
190	61.6	445.6	92,300	155,600									190
195	60.3	442.7	88,000	155,600									195
200	59.0	439.6	84,000	155,600									200
205	57.6	436.4	80,200	155,600									205
210	56.3	433.0	76,500	155,600									210
215	54.9	429.5	73,100	154,300	59.9	435.6	55,900	141,500					215
220	53.4	425.7	69,700	149,400	58.6	432.6	52,900	136,900					220
230	50.5	417.6	63,500	140,400	55.9	425.9	47,500	128,500					230
240	47.5	408.6	57,800	132,100	53.0	418.4	42,500	120,700					240
250	44.3	398.6	52,600	124,500	50.1	410.2	37,900	113,600					250
260	40.8	387.3	47,700	117,500	47.0	401.1	33,600	107,100	52.4	409.1	96,900		260
270	37.2	374.5	43,100	111,000	43.8	390.8	29,700	101,000	49.5	400.7	91,200		270
280	33.1	359.7	38,900	105,000	40.3	379.4	26,000	95,300	46.4	391.3	86,000		280
290	28.6	342.3	34,900	99,400	36.6	366.3	22,500	90,100	43.1	380.8	81,100		290
300	23.2	320.7	31,000	94,100	32.5	351.2		85,200	39.6	369.1	76,500		300
310	16.0	290.9	27,300	89,000	27.8	333.3		80,500	35.8	355.6	72,100		310
320					22.3	310.8		76,100	31.6	340.0	68,100		320
330					14.7	279.0		71,900	26.8	321.3	64,200		330
340									20.9	297.6	60,600		340
350									12.5	262.0	57,000		350

# MLC650 VPC-MAX S-2

ASME B30.5



661,300 lb

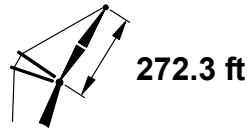
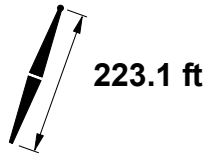

ft	85°				83°				80°				ft
	ft	lb	lb	lb	ft	lb	lb	lb	ft	lb	lb	lb	
105	74.4	493.9	150,500	150,500									105
110	73.3	492.4	150,300	150,300									110
115	72.2	490.7	149,500	149,500									115
120	71.1	489.0	149,200	149,200	72.8	490.7	148,600	148,600					120
125	70.0	487.1	148,700	148,700	71.7	489.0	148,600	148,600					125
130	68.9	485.1	148,100	148,100	70.6	487.2	148,600	148,600					130
135	67.7	483.1	147,500	147,500	69.5	485.3	148,500	148,500					135
140	66.6	480.9	146,800	146,800	68.4	483.3	148,300	148,300					140
145	65.4	478.5	146,100	146,100	67.2	481.2	148,000	148,000	69.8	484.0	144,500	144,500	145
150	64.2	476.1	145,300	145,300	66.1	478.9	147,700	147,700	68.7	482.0	144,500	144,500	150
155	63.1	473.5	144,500	144,500	64.9	476.5	147,300	147,300	67.6	479.9	144,500	144,500	155
160	61.9	470.8	143,700	143,700	63.7	474.0	146,800	146,800	66.4	477.7	144,500	144,500	160
165	60.7	467.9	142,800	142,800	62.5	471.4	146,300	146,300	65.3	475.4	138,000	144,500	165
170	59.4	464.9	139,500	139,500	61.3	468.6	145,700	145,800	64.1	472.9	131,700	144,500	170
175	58.2	461.8	135,800	135,800	60.1	465.7	139,400	145,200	62.9	470.3	125,800	144,500	175
180	56.9	458.5	132,100	132,100	58.9	462.6	133,400	144,600	61.7	467.6	120,200	144,500	180
185	55.7	455.1	128,400	128,400	57.6	459.4	127,800	143,900	60.5	464.7	114,900	144,500	185
190	54.4	451.4	124,800	124,800	56.4	456.1	122,400	143,300	59.3	461.7	109,900	144,500	190
195	53.0	447.6	121,100	121,100	55.1	452.5	117,300	139,800	58.0	458.5	105,200	144,500	195
200	51.7	443.6	117,600	117,600	53.8	448.8	112,500	136,200	56.8	455.2	100,700	144,500	200
205	50.3	439.5	114,100	114,100	52.4	444.9	107,900	132,500	55.5	451.7	96,400	144,500	205
210	48.9	435.1	110,600	110,600	51.1	440.9	103,500	128,800	54.2	448.1	92,300	144,500	210
215	47.5	430.4	106,700	107,300	49.7	436.6	99,400	125,200	52.8	444.3	88,400	144,300	215
220	46.0	425.6	102,500	104,100	48.3	432.1	95,400	121,700	51.5	440.3	84,700	143,900	220
230	43.0	415.1	94,800	97,900	45.3	422.4	87,900	114,700	48.7	431.6	77,700	141,800	230
240	39.7	403.3	87,600	92,300	42.2	411.6	81,100	108,200	45.8	422.1	71,400	134,600	240
250	36.2	390.1	81,000	87,300	39.0	399.5	74,800	102,000	42.7	411.5	65,500	127,500	250
260	32.4	374.9	74,900	82,800	35.4	385.9	68,900	96,400	39.5	399.6	60,000	120,600	260
270	28.1	357.1	69,200	79,100	31.5	370.2	63,500	91,500	36.0	386.3	55,000	114,000	270
280	23.0	335.3	63,800	76,400	27.0	351.7	58,400	87,200	32.1	370.9	50,200	108,000	280
290	16.5	306.0	58,700	75,100	21.8	328.6	53,600	84,100	27.8	352.9	45,800	102,600	290
300	1.8	236.7	53,200	61,200	14.7	296.5	48,900	82,600	22.7	330.7	41,500	98,200	300
310									16.0	300.6	37,400	90,900	310
320													320
330													330
340													340
350													350
360													360
370													370



# MLC650 VPC-MAX S-2

ASME B30.5

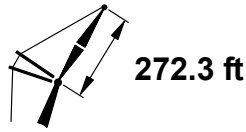
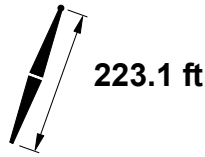
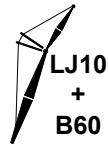

ft	75°				70°				65°				ft
	ft	°	ft	lb	ft	°	ft	lb	ft	°	ft	lb	
105													105
110													110
115													115
120													120
125													125
130													130
135													135
140													140
145													145
150													150
155													155
160													160
165													165
170													170
175													175
180													180
185													185
190	63.8	467.9	89,500	135,900									190
195	62.7	465.3	85,300	135,900									195
200	61.5	462.5	81,300	135,900									200
205	60.2	459.6	77,500	135,900									205
210	59.0	456.6	73,900	135,900									210
215	57.8	453.4	70,400	135,900									215
220	56.5	450.0	67,200	135,900									220
230	53.9	442.8	61,000	135,900	58.6	449.5	44,700	124,600					230
240	51.2	434.9	55,400	130,100	56.1	442.9	39,700	118,500					240
250	48.4	426.2	50,200	122,600	53.5	435.6	35,200	111,400					250
260	45.5	416.5	45,400	115,600	50.8	427.6	31,000	104,900					260
270	42.4	405.8	40,900	109,200	48.0	418.7	27,100	98,900	53.0	426.3	89,000		270
280	39.1	393.9	36,700	103,200	45.1	408.9	23,500	93,300	50.2	418.1	83,800		280
290	35.6	380.3	32,800	97,600	42.0	398.0	20,100	88,100	47.4	409.0	78,900		290
300	31.7	364.7	29,100	92,400	38.6	385.8		83,300	44.4	399.0	74,400		300
310	27.3	346.4	25,700	87,500	35.0	372.0		78,700	41.3	387.9	70,100		310
320	22.1	323.6	22,300	82,900	31.1	356.1		74,400	37.9	375.4	66,100		320
330	15.1	292.2		78,500	26.6	337.2		70,400	34.3	361.2	62,400		330
340					21.2	313.6		66,500	30.2	344.7	58,800		340
350					13.8	280.0		62,800	25.6	325.0	55,400		350
360									19.9	300.0	52,200		360
370									11.7	262.3	49,000		370

# MLC650 VPC-MAX S-2

ASME B30.5



661,300 lb

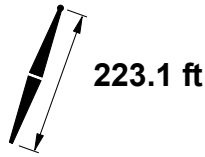

223.1 ft

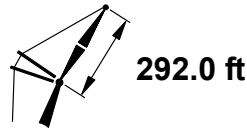

292.0 ft

ft	85°				83°				80°				ft
	ft	lb	lb	lb	ft	lb	lb	lb	ft	lb	lb	lb	
110	74.5	512.9	129,500	129,500									110
115	73.5	511.4	129,200	129,200									115
120	72.4	509.8	128,900	128,900									120
125	71.4	508.1	128,500	128,500									125
130	70.4	506.3	128,000	128,000	72.0	508.1	128,100	128,100					130
135	69.3	504.3	127,500	127,500	70.9	506.3	127,700	127,700					135
140	68.3	502.3	126,900	126,900	69.9	504.5	127,500	127,500					140
145	67.2	500.2	126,300	126,300	68.8	502.5	127,200	127,200					145
150	66.1	497.9	125,700	125,700	67.8	500.4	126,900	126,900					150
155	65.0	495.6	125,000	125,000	66.7	498.2	126,500	126,500	69.2	501.2	123,800	123,800	155
160	63.9	493.1	124,300	124,300	65.6	495.9	126,100	126,100	68.1	499.2	123,800	123,800	160
165	62.8	490.5	123,500	123,500	64.5	493.5	125,700	125,700	67.0	497.0	123,800	123,800	165
170	61.7	487.7	122,800	122,800	63.4	491.0	125,200	125,200	66.0	494.8	123,800	123,800	170
175	60.6	484.9	122,000	122,000	62.3	488.3	124,700	124,700	64.9	492.4	121,700	123,800	175
180	59.4	481.9	121,200	121,200	61.2	485.6	124,200	124,200	63.8	489.9	116,200	123,800	180
185	58.3	478.8	118,900	118,900	60.1	482.6	123,600	123,600	62.7	487.3	110,900	123,800	185
190	57.1	475.5	115,900	115,900	58.9	479.6	118,600	123,000	61.6	484.5	105,900	123,800	190
195	55.9	472.1	112,900	112,900	57.8	476.4	113,500	122,400	60.4	481.7	101,200	123,600	195
200	54.7	468.5	109,900	109,900	56.6	473.1	108,700	121,800	59.3	478.7	96,700	123,300	200
205	53.5	464.8	107,000	107,000	55.4	469.6	104,100	121,200	58.1	475.5	92,400	123,100	205
210	52.2	460.9	104,000	104,000	54.2	465.9	99,800	120,000	56.9	472.2	88,400	122,800	210
215	51.0	456.8	101,100	101,100	52.9	462.1	95,600	117,100	55.8	468.8	84,500	122,500	215
220	49.7	452.5	98,300	98,300	51.7	458.1	91,700	114,100	54.5	465.2	80,800	122,200	220
230	47.0	443.3	91,200	92,800	49.1	449.6	84,300	108,200	52.1	457.5	73,900	121,500	230
240	44.2	433.2	84,100	87,600	46.4	440.2	77,500	102,500	49.5	449.1	67,500	120,800	240
250	41.3	422.1	77,600	82,800	43.6	429.9	71,200	97,000	46.8	439.8	61,700	119,900	250
260	38.2	409.7	71,500	78,300	40.6	418.5	65,400	91,800	44.0	429.7	56,300	114,200	260
270	34.8	395.7	65,900	74,300	37.4	405.8	60,000	86,900	41.1	418.5	51,300	108,500	270
280	31.1	379.8	60,600	70,800	34.0	391.4	55,000	82,500	37.9	406.0	46,600	103,100	280
290	26.9	361.1	55,700	67,900	30.2	374.9	50,300	78,500	34.6	391.9	42,200	97,900	290
300	22.0	338.2	51,000	65,700	25.9	355.5	45,900	75,200	30.8	375.8	38,100	93,100	300
310	15.7	307.4	46,500	64,800	20.8	331.3	41,600	72,700	26.6	356.8	34,200	88,800	310
320					13.9	297.4	37,500	69,800	21.7	333.6	30,500	85,300	320
330									15.2	301.9	26,900	75,300	330
340													340
350													350
360													360
370													370
380													380
390													390

# MLC650 VPC-MAX S-2

ASME B30.5

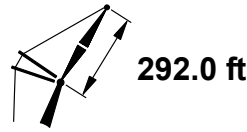
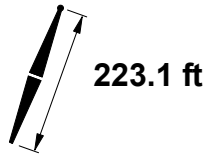
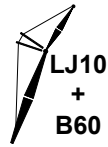

ft	75°				70°			65°			ft
	ft	lb	lb	lb	ft	lb	lb	ft	lb	lb	
110											110
115											115
120											120
125											125
130											130
135											135
140											140
145											145
150											150
155											155
160											160
165											165
170											170
175											175
180											180
185											185
190											190
195	64.7	487.4	80,900	114,800							195
200	63.6	484.9	77,000	114,800							200
205	62.4	482.2	73,200	114,800							205
210	61.3	479.5	69,600	114,800							210
215	60.2	476.6	66,200	114,800							215
220	59.0	473.5	62,900	114,800							220
230	56.7	467.0	56,800	114,800							230
240	54.3	459.9	51,200	114,800	58.7	466.5	105,100				240
250	51.8	452.2	46,100	114,800	56.4	459.9	105,100				250
260	49.2	443.7	41,300	112,400	53.9	452.7	101,600				260
270	46.6	434.4	36,900	106,000	51.4	444.8	95,600				270
280	43.7	424.1	32,800	100,100	48.8	436.2	90,000	53.4	443.4	80,300	280
290	40.8	412.8	29,000	94,600	46.2	426.8	84,900	50.9	435.4	75,500	290
300	37.6	400.1	25,300	89,400	43.3	416.4	80,100	48.3	426.6	71,000	300
310	34.2	385.8	21,900	84,600	40.3	404.8	75,500	45.6	417.0	66,800	310
320	30.4	369.5		80,000	37.1	392.0	71,300	42.7	406.4	62,800	320
330	26.2	350.2		75,700	33.7	377.4	67,300	39.7	394.6	59,100	330
340	21.1	326.4		71,700	29.8	360.7	63,500	36.4	381.4	55,600	340
350	14.3	293.3		67,800	25.5	340.9	60,000	32.9	366.4	52,300	350
360					20.2	316.2	56,500	29.0	349.2	49,200	360
370					13.0	280.7	53,200	24.5	328.5	46,200	370
380								19.0	302.3	43,300	380
390								10.9	262.4	40,400	390

# MLC650 VPC-MAX S-2

ASME B30.5



661,300 lb

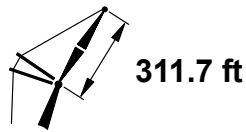
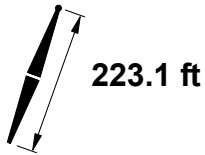

ft	85°				83°				80°				ft
	ft	lb	lb	lb	ft	lb	lb	lb	ft	lb	lb	lb	
115	74.6	532.0	112,900	112,900									115
120	73.6	530.5	112,500	112,500									120
125	72.6	528.9	111,900	111,900									125
130	71.7	527.2	111,500	111,500									130
135	70.7	525.4	111,000	111,000	72.2	527.2	110,800	110,800					135
140	69.7	523.5	110,600	110,600	71.2	525.5	110,600	110,600					140
145	68.7	521.5	110,100	110,100	70.2	523.6	110,400	110,400					145
150	67.7	519.5	109,500	109,500	69.3	521.7	110,100	110,100					150
155	66.7	517.3	108,900	108,900	68.3	519.7	109,800	109,800					155
160	65.7	515.0	108,300	108,300	67.3	517.6	109,400	109,400	69.6	520.4	106,900	106,900	160
165	64.7	512.6	107,700	107,700	66.3	515.3	109,000	109,000	68.6	518.4	106,900	106,900	165
170	63.7	510.1	107,000	107,000	65.2	513.0	108,600	108,600	67.6	516.3	106,900	106,900	170
175	62.6	507.4	106,400	106,400	64.2	510.5	108,200	108,200	66.6	514.1	106,900	106,900	175
180	61.6	504.7	105,700	105,700	63.2	508.0	107,700	107,700	65.6	511.8	106,900	106,900	180
185	60.5	501.8	105,000	105,000	62.1	505.3	107,200	107,200	64.5	509.4	106,700	106,700	185
190	59.4	498.9	104,300	104,300	61.1	502.5	106,700	106,700	63.5	506.9	103,500	106,600	190
195	58.4	495.7	103,600	103,600	60.0	499.6	106,200	106,200	62.5	504.3	98,800	106,400	195
200	57.3	492.5	101,800	101,800	59.0	496.5	105,700	105,700	61.4	501.5	94,300	106,200	200
205	56.1	489.1	99,300	99,300	57.9	493.4	102,000	105,100	60.4	498.6	90,100	106,000	205
210	55.0	485.6	96,900	96,900	56.8	490.1	97,700	104,600	59.3	495.6	86,000	105,700	210
215	53.9	481.9	94,400	94,400	55.6	486.6	93,500	104,000	58.2	492.5	82,200	105,500	215
220	52.7	478.1	92,000	92,000	54.5	483.0	89,600	103,500	57.1	489.2	78,500	105,200	220
230	50.3	469.9	87,200	87,200	52.2	475.3	82,200	100,900	54.9	482.3	71,600	104,500	230
240	47.9	461.0	82,200	82,600	49.8	467.0	75,400	96,100	52.6	474.7	65,300	103,900	240
250	45.3	451.2	75,700	78,100	47.3	457.9	69,200	91,300	50.2	466.5	59,500	103,200	250
260	42.6	440.6	69,700	73,900	44.7	448.0	63,500	86,600	47.7	457.5	54,200	102,500	260
270	39.8	428.8	64,100	70,100	42.0	437.1	58,100	82,300	45.1	447.7	49,200	101,800	270
280	36.8	415.8	58,900	66,500	39.1	425.1	53,100	78,000	42.4	437.0	44,600	97,200	280
290	33.5	401.1	54,000	63,300	36.1	411.7	48,500	74,100	39.6	425.1	40,200	92,600	290
300	29.9	384.4	49,500	60,500	32.7	396.6	44,100	70,600	36.6	412.0	36,200	88,200	300
310	25.9	364.9	45,100	58,200	29.1	379.4	40,000	67,400	33.3	397.2	32,400	84,000	310
320	21.1	341.0	41,000	56,600	24.9	359.0	36,100	64,800	29.7	380.4	28,800	80,200	320
330	14.9	308.7	37,100	56,000	19.9	333.8	32,400	62,900	25.6	360.6	25,300	76,700	330
340					13.1	298.2	28,700	58,100	20.8	336.3	22,100	74,000	340
350									14.4	303.1		63,200	350
360													360
370													370
380													380
390													390
400													400
410													410

# MLC650 VPC-MAX S-2

ASME B30.5

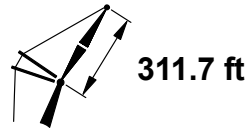
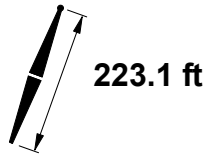

ft	75°				70°			65°			ft
	°	ft	lb	lb	°	ft	lb	°	ft	lb	
115											115
120											120
125											125
130											130
135											135
140											140
145											145
150											150
155											155
160											160
165											165
170											170
175											175
180											180
185											185
190											190
195											195
200											200
205	64.3	504.4	70,500	98,700							205
210	63.3	501.9	66,900	98,700							210
215	62.3	499.2	63,500	98,700							215
220	61.2	496.4	60,300	98,700							220
230	59.1	490.5	54,300	98,700							230
240	56.9	484.0	48,700	98,700							240
250	54.6	477.0	43,600	98,700	58.8	483.4	89,800				250
260	52.3	469.4	38,900	98,700	56.6	476.9	89,800				260
270	49.9	461.1	34,500	98,700	54.3	469.8	89,800				270
280	47.5	452.0	30,400	98,200	52.0	462.1	88,000				280
290	44.9	442.2	26,600	92,700	49.6	453.7	82,800	53.8	460.5	73,300	290
300	42.2	431.3	23,100	87,600	47.1	444.5	78,100	51.5	452.7	68,800	300
310	39.3	419.4		82,800	44.5	434.5	73,600	49.1	444.1	64,700	310
320	36.2	406.1		78,300	41.8	423.5	69,400	46.6	434.8	60,800	320
330	32.9	391.1		74,000	38.9	411.4	65,400	43.9	424.6	57,100	330
340	29.3	374.0		70,000	35.8	397.9	61,700	41.2	413.4	53,600	340
350	25.2	353.9		66,300	32.4	382.6	58,200	38.2	401.0	50,400	350
360	20.2	328.9		62,600	28.7	365.1	54,900	35.1	387.1	47,300	360
370	13.6	294.2		59,200	24.5	344.4	51,700	31.7	371.5	44,300	370
380					19.4	318.5	48,600	27.9	353.4	41,500	380
390					12.3	281.2	45,600	23.5	331.8	38,800	390
400								18.1	304.4	36,200	400
410								10.2	262.2	33,600	410

# MLC650 VPC-MAX S-2

ASME B30.5



661,300 lb

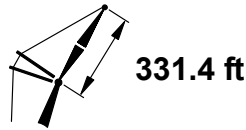
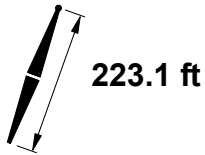

ft	85°				83°				80°				ft
	ft	lb	lb	lb	ft	lb	lb	lb	ft	lb	lb	lb	
120	74.6	551.0	94,400	94,400									120
125	73.7	549.5	94,100	94,100									125
130	72.8	547.9	93,700	93,700									130
135	71.9	546.3	93,300	93,300									135
140	71.0	544.5	92,900	92,900	72.4	546.3	92,600	92,600					140
145	70.0	542.7	92,500	92,500	71.5	544.6	92,300	92,300					145
150	69.1	540.7	92,000	92,000	70.5	542.8	92,000	92,000					150
155	68.2	538.7	91,500	91,500	69.6	540.9	91,700	91,700					155
160	67.2	536.6	91,000	91,000	68.7	538.9	91,400	91,400					160
165	66.3	534.3	90,500	90,500	67.8	536.8	91,100	91,100	69.9	539.6	88,900	88,900	165
170	65.3	532.0	89,900	89,900	66.8	534.7	90,700	90,700	69.0	537.6	88,800	88,800	170
175	64.4	529.6	89,400	89,400	65.9	532.4	90,300	90,300	68.0	535.6	88,800	88,800	175
180	63.4	527.1	88,900	88,900	64.9	530.0	89,900	89,900	67.1	533.5	88,700	88,700	180
185	62.4	524.4	88,300	88,300	63.9	527.5	89,500	89,500	66.2	531.2	88,500	88,500	185
190	61.4	521.7	87,800	87,800	63.0	525.0	89,100	89,100	65.2	528.9	88,400	88,400	190
195	60.4	518.8	87,200	87,200	62.0	522.3	88,700	88,700	64.2	526.4	88,200	88,200	195
200	59.4	515.8	86,600	86,600	61.0	519.5	88,200	88,200	63.3	523.9	88,000	88,000	200
205	58.4	512.7	86,100	86,100	60.0	516.5	87,800	87,800	62.3	521.2	86,200	87,700	205
210	57.4	509.5	85,500	85,500	59.0	513.5	87,300	87,300	61.3	518.5	82,200	87,500	210
215	56.4	506.1	85,000	85,000	58.0	510.3	86,900	86,900	60.3	515.6	78,300	87,300	215
220	55.3	502.6	84,400	84,400	56.9	507.1	86,000	86,400	59.3	512.6	74,700	87,000	220
230	53.1	495.2	80,800	80,800	54.8	500.1	78,600	85,500	57.2	506.2	67,800	86,400	230
240	50.9	487.2	77,000	77,000	52.7	492.5	71,900	84,600	55.2	499.3	61,600	85,900	240
250	48.6	478.5	72,300	73,200	50.4	484.4	65,700	83,700	53.0	491.9	55,800	85,300	250
260	46.3	469.1	66,300	69,500	48.1	475.5	59,900	80,900	50.8	483.8	50,500	84,700	260
270	43.8	458.8	60,700	65,800	45.7	465.9	54,600	77,200	48.5	475.1	45,500	84,100	270
280	41.2	447.6	55,600	62,400	43.2	455.4	49,700	73,500	46.1	465.6	40,900	83,500	280
290	38.4	435.3	50,700	59,600	40.6	444.0	45,100	70,000	43.6	455.2	36,600	83,000	290
300	35.5	421.6	46,200	56,700	37.8	431.4	40,800	66,700	41.0	443.9	32,600	79,500	300
310	32.4	406.3	42,000	54,000	34.8	417.4	36,700	63,500	38.2	431.5	28,900	74,400	310
320	28.9	388.9	38,000	51,800	31.6	401.7	32,900	60,300	35.3	417.8	25,300	69,200	320
330	25.0	368.5	34,100	50,000	28.0	383.7	29,300	55,900	32.1	402.3	22,000	63,900	330
340	20.3	343.6	30,500	46,000	24.0	362.4	25,800	51,000	28.6	384.7		58,700	340
350	14.2	309.8	26,900	41,600	19.1	336.1	22,500	46,200	24.7	364.1		53,600	350
360					12.4	298.7		41,800	19.9	338.8		48,600	360
370									13.7	304.0		43,900	370
380													380
390													390
400													400
410													410
420													420
430													430

# MLC650 VPC-MAX S-2

ASME B30.5

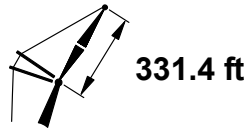
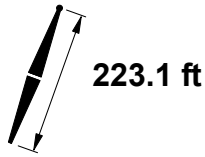

ft	75°				70°			65°			ft
	ft	ft	lb	lb	ft	lb	ft	lb	ft		
120											120
125											125
130											130
135											135
140											140
145											145
150											150
155											155
160											160
165											165
170											170
175											175
180											180
185											185
190											190
195											195
200											200
205											205
210											210
215	64.0	521.4	59,400	81,700							215
220	63.1	518.9	56,200	81,700							220
230	61.1	513.4	50,100	81,700							230
240	59.1	507.5	44,600	81,700							240
250	57.0	501.0	39,600	81,700							250
260	54.9	494.1	34,900	81,700	58.8	500.4	74,000				260
270	52.8	486.6	30,600	81,700	56.7	493.9	74,000				270
280	50.5	478.4	26,500	81,700	54.6	486.9	74,000				280
290	48.2	469.6	22,800	81,700	52.4	479.3	74,000				290
300	45.8	460.1		81,700	50.2	471.1	74,000	54.2	477.6	65,500	300
310	43.3	449.6		79,800	47.9	462.1	70,400	52.0	469.9	61,400	310
320	40.7	438.3		75,300	45.5	452.5	66,300	49.7	461.5	57,500	320
330	38.0	425.7		71,100	43.0	441.9	62,400	47.4	452.5	53,900	330
340	35.0	411.8		67,200	40.3	430.3	58,700	45.0	442.6	50,400	340
350	31.8	396.2		63,400	37.5	417.6	55,200	42.4	431.9	47,200	350
360	28.2	378.3		59,900	34.5	403.5	51,900	39.8	420.1	44,200	360
370	24.2	357.3		55,400	31.3	387.6	48,800	36.9	407.1	41,200	370
380	19.4	331.3		50,400	27.7	369.3	45,800	33.9	392.6	38,500	380
390	12.9	294.9		45,600	23.6	347.7	42,900	30.6	376.3	35,900	390
400					18.6	320.7	40,200	26.9	357.4	33,300	400
410					11.6	281.5	37,500	22.6	334.9	30,900	410
420								17.4	306.3	28,600	420
430								9.5	261.7	26,200	430

# MLC650 VPC-MAX S-2

ASME B30.5

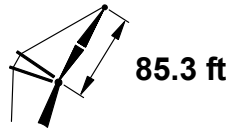
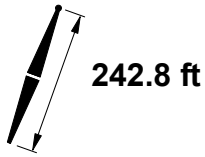

ft	85°				83°				80°				ft
	ft	lb	lb	lb	ft	lb	lb	lb	ft	lb	lb	lb	
60	72.0	332.1	517,200 d	517,200 d									60
65	68.3	330.0	512,300 c	512,300 c									65
70	64.6	327.5	499,600 c	505,300 c	70.9	330.5	477,900 c	521,500 c					70
75	60.7	324.6	460,700 b	478,000 b	67.2	328.3	440,700 c	518,000 c					75
80	56.6	321.2	427,000 b	446,000 b	63.4	325.6	408,400 c	512,700 c					80
85	52.4	317.2	397,300 b	418,700 b	59.5	322.6	380,000 b	502,000 b	69.1	327.4	354,000 c	522,600 c	85
90	47.8	312.5	371,100	395,600	55.3	319.0	354,900 b	468,200 b	65.4	325.0	330,500 c	522,600 c	90
95	42.8	307.1	347,600	376,500	51.0	314.8	332,500	439,400	61.5	322.2	309,600 b	496,500 b	95
100	37.2	300.4	326,500	361,200	46.3	309.9	312,400	415,200	57.5	318.9	290,900 b	467,300 b	100
105	30.7	292.1	307,300	350,400	41.1	304.1	294,200	395,100	53.3	315.0	274,000 b	441,200 b	105
110	22.3	280.6	289,600	345,500	35.3	297.1	277,600	379,200	48.7	310.5	258,600	417,700	110
115					28.4	288.0	262,300	368,100	43.8	305.2	244,500	396,300	115
120					18.8	274.7	247,900	364,100	38.4	298.8	231,600	376,800	120
125									32.1	290.9	219,500	358,900	125
130									24.3	280.3	208,200	342,400	130
135									11.0	261.2	197,000	326,900	135
140													140
145													145
150													150
155													155
160													160
165													165
170													170
175													175
180													180
185													185
190													190
195													195



# MLC650 VPC-MAX S-2

ASME B30.5

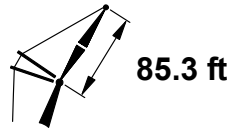
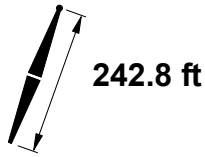
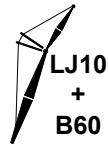

ft	75°				70°				65°				ft
	ft	°	ft	lb	ft	°	ft	lb	ft	°	ft	lb	
60													60
65													65
70													70
75													75
80													80
85													85
90													90
95													95
100													100
105													105
110													110
115	62.0	317.7	214,100 b	372,800 b									115
120	58.0	314.5	202,800 b	354,400 b									120
125	53.8	310.7	192,300 b	337,700 b									125
130	49.4	306.3	182,600	322,200									130
135	44.5	301.1	173,600	308,000									135
140	39.2	294.9	165,200	294,800	58.2	307.9	141,400 b	276,500 b					140
145	33.0	287.2	157,200	282,500	54.0	304.2	134,600 b	265,000 b					145
150	25.5	277.1	149,600	271,000	49.5	299.8	128,200	254,400					150
155	13.7	260.3	142,000	260,000	44.7	294.6	122,200	244,400					155
160					39.4	288.5	116,500	235,000					160
165					33.3	280.9	111,000	226,200	53.5	295.4	91,900	211,500	165
170					25.7	270.8	105,700	217,800	49.0	290.9	87,500	203,800	170
175					14.3	254.5	100,200	209,600	44.2	285.7	83,400	196,500	175
180									38.8	279.4	79,400	189,600	180
185									32.6	271.6	75,500	183,000	185
190									24.9	261.3	71,700	176,700	190
195									12.4	243.4	67,500	170,400	195

# MLC650 VPC-MAX S-2

ASME B30.5

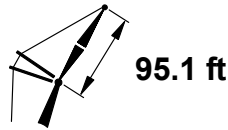
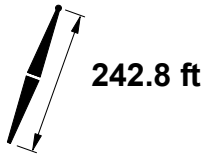

ft	85°				83°				80°				ft
	ft	lb	lb	lb	ft	lb	lb	lb	ft	lb	lb	lb	
60	73.9	342.6	478,700 c	478,700 c									60
65	70.7	340.7	476,800 c	476,800 c									65
70	67.4	338.5	471,700 c	471,700 c	72.9	341.0	475,000 c	482,000 c					70
75	64.1	336.0	458,300 b	465,500 b	69.7	339.1	437,800 c	481,300 c					75
80	60.6	333.0	424,600 b	442,000 b	66.4	336.8	405,600 b	478,100 b					80
85	57.0	329.7	395,100 b	414,200 b	63.0	334.1	377,300 b	473,200 b					85
90	53.2	325.8	369,000	390,000	59.5	331.0	352,300 b	466,900 b	68.1	335.9	327,400 b	483,000 b	90
95	49.1	321.4	345,700	369,200	55.8	327.5	330,100	437,100	64.8	333.5	306,600 b	483,000 b	95
100	44.8	316.3	324,800	351,600	51.9	323.5	310,100	411,400	61.3	330.6	288,000 b	464,500 b	100
105	40.1	310.3	305,900	337,000	47.8	318.9	292,100	389,400	57.7	327.4	271,200 b	438,500 b	105
110	34.9	303.1	288,700	325,600	43.4	313.5	275,700	370,700	53.9	323.6	256,000	415,100	110
115	28.7	294.1	272,800	317,900	38.6	307.2	260,700	355,400	50.0	319.3	242,000	393,800	115
120	20.6	281.7	258,000	315,600	33.1	299.5	246,800	343,400	45.7	314.3	229,300	374,500	120
125					26.4	289.7	234,000	335,600	41.1	308.5	217,500	356,700	125
130					17.3	275.4	221,800	332,100	36.0	301.6	206,500	340,400	130
135									30.0	293.1	196,300	325,300	135
140									22.5	281.6	186,600	311,300	140
145									9.4	260.5	176,800	298,000	145
150													150
155													155
160													160
165													165
170													170
175													175
180													180
185													185
190													190
195													195
200													200
205													205

# MLC650 VPC-MAX S-2

ASME B30.5

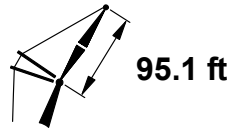
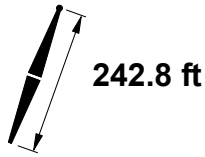
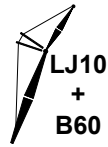

ft	75°				70°				65°				ft
	ft	°	ft	lb	ft	°	ft	lb	ft	°	ft	lb	
60													60
65													65
70													70
75													75
80													80
85													85
90													90
95													95
100													100
105													105
110													110
115													115
120	61.8	326.2	199,500 b	351,600 b									120
125	58.2	323.0	189,200 b	334,900 b									125
130	54.5	319.3	179,700	319,600									130
135	50.5	315.0	170,800	305,500									135
140	46.3	310.2	162,500	292,400									140
145	41.8	304.5	154,800	280,300	58.3	316.4	131,200	262,300					145
150	36.7	297.8	147,500	269,000	54.6	312.7	125,000	251,700					150
155	30.9	289.5	140,600	258,300	50.6	308.5	119,100	241,800					155
160	23.7	278.6	133,900	248,300	46.5	303.7	113,500	232,500					160
165	12.2	260.3	127,200	238,700	41.9	298.0	108,300	223,800					165
170					36.9	291.3	103,300	215,600	54.2	304.0	84,100	201,100	170
175					31.1	283.1	98,400	207,900	50.2	299.7	80,100	193,900	175
180					23.9	272.3	93,700	200,500	46.0	294.8	76,300	187,100	180
185					12.8	254.5	88,800	193,200	41.4	289.1	72,600	180,600	185
190									36.4	282.2	69,100	174,500	190
195									30.5	273.8	65,600	168,600	195
200									23.1	262.7	62,200	163,000	200
205									10.9	243.1	58,400	157,300	205

# MLC650 VPC-MAX S-2

ASME B30.5



661,300 lb

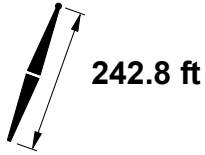

242.8 ft

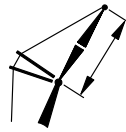

105.0 ft

ft	85°				83°				80°				ft
	ft	lb	lb	lb	ft	lb	lb	lb	ft	lb	lb	lb	
65	72.6	351.2	444,500 c	444,500 c									65
70	69.7	349.3	441,600 c	441,600 c									70
75	66.7	347.0	436,800 b	436,800 b									75
80	63.6	344.4	431,200 b	431,200 b	71.7	349.6	448,100 c	448,100 c					80
85	60.5	341.5	410,200 b	410,200 b	68.8	347.6	429,300 b	446,900 b					85
					65.8	345.3	399,600 b	443,500 b					
90	57.2	338.2	385,700	385,700	62.7	342.6	373,300 b	439,100 b					90
95	53.8	334.4	364,300	364,300	59.5	339.5	349,900 b	433,800 b	67.3	344.5	326,000 b	449,500 b	95
100	50.2	330.2	344,000	345,600	56.1	336.1	328,900	409,200	64.3	341.9	306,300 b	448,500 b	100
105	46.4	325.3	324,200	329,500	52.7	332.2	310,000	386,200	61.1	339.1	288,600 b	436,700 b	105
110	42.3	319.8	306,200	315,900	49.0	327.7	292,800	366,200	57.9	335.9	272,500	413,400	110
115	37.9	313.3	289,800	304,700	45.2	322.7	277,100	349,000	54.5	332.2	257,900	392,300	115
120	32.9	305.6	274,700	296,100	41.0	316.9	262,700	334,500	50.9	328.0	244,500	373,000	120
125	26.9	296.0	260,800	290,900	36.4	310.0	249,500	322,500	47.2	323.3	232,100	355,400	125
130	19.2	282.7	247,600	290,300	31.1	301.8	237,100	313,600	43.2	317.9	220,700	339,200	130
135					24.8	291.4	225,600	308,100	38.8	311.6	210,100	324,200	135
140					15.9	275.9	214,600	304,700	33.9	304.2	200,200	310,400	140
145									28.2	295.1	190,900	297,500	145
150									21.0	282.8	182,000	285,500	150
155									8.0	259.4	173,000	273,600	155
160													160
165													165
170													170
175													175
180													180
185													185
190													190
195													195
200													200
205													205
210													210
215													215

# MLC650 VPC-MAX S-2

ASME B30.5

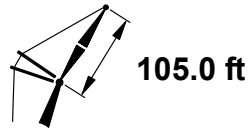
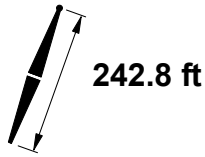
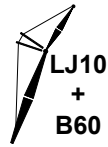

ft	75°				70°				65°				ft
	ft	°	ft	lb	ft	°	ft	lb	ft	°	ft	lb	
65													65
70													70
75													75
80													80
85													85
90													90
95													95
100													100
105													105
110													110
115													115
120	64.7	337.4	214,100	349,800									120
125	61.5	334.6	203,200	333,200									125
130	58.3	331.4	193,100	318,000									130
135	55.0	327.8	183,700	303,900									135
140	51.4	323.8	175,000	291,000									140
145	47.7	319.1	166,900	278,900									145
150	43.7	313.8	159,300	267,700	58.4	324.9	136,100	250,000					150
155	39.4	307.7	152,100	257,200	55.1	321.3	129,900	240,200					155
160	34.6	300.4	145,400	247,400	51.5	317.2	124,000	231,000					160
165	29.1	291.6	138,900	238,100	47.8	312.6	118,500	222,400					165
170	22.1	279.9	132,700	229,400	43.9	307.3	113,300	214,300					170
175	10.9	260.0	126,300	220,900	39.6	301.2	108,300	206,700	54.7	312.6	89,300	192,300	175
180					34.8	294.0	103,500	199,400	51.2	308.4	85,200	185,600	180
185					29.3	285.2	98,900	192,600	47.5	303.8	81,400	179,200	185
190					22.4	273.7	94,400	186,000	43.5	298.4	77,700	173,200	190
195					11.5	254.4	89,700	179,500	39.1	292.2	74,200	167,400	195
200									34.3	284.9	70,700	161,900	200
205									28.7	275.9	67,400	156,700	205
210									21.6	263.9	64,100	151,600	210
215									9.6	242.5	60,400	146,500	215

# MLC650 VPC-MAX S-2

ASME B30.5



661,300 lb

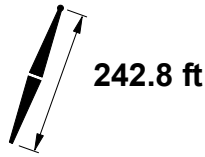

242.8 ft

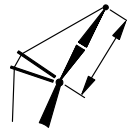

114.8 ft

ft	85°				83°				80°				ft
	ft	lb	lb	lb	ft	lb	lb	lb	ft	lb	lb	lb	
65	74.2	361.6	413,900 c	413,900 c									65
70	71.5	359.9	412,500 b	412,500 b									70
75	68.8	357.8	409,300 b	409,300 b									75
80	66.1	355.5	405,000 b	405,000 b	70.7	358.3	416,200 b	416,200 b					80
85	63.3	352.9	399,900 b	399,900 b	68.0	356.1	396,700 b	414,700 b					85
90	60.4	350.0	381,700	381,700	65.2	353.7	370,500 b	414,700 b					90
95	57.4	346.7	360,000	360,000	62.4	351.0	347,200	407,800	69.4	355.2	322,800 b	415,900 b	95
100	54.3	343.0	340,800	340,800	59.5	348.0	326,300	403,200	66.6	353.0	303,300 b	415,900 b	100
105	51.1	338.9	322,000	324,100	56.4	344.6	307,400	383,900	63.9	350.4	285,600	415,900	105
110	47.7	334.3	304,100	309,400	53.3	340.8	290,300	363,200	61.0	347.6	269,600	410,700	110
115	44.1	329.0	287,800	296,800	50.0	336.5	274,700	345,000	58.0	344.4	255,100	389,600	115
120	40.2	323.0	272,900	286,100	46.6	331.7	260,500	329,200	54.9	340.8	241,700	370,500	120
125	35.9	316.1	259,200	277,500	42.9	326.2	247,300	315,600	51.7	336.7	229,500	352,900	125
130	31.1	307.9	246,400	271,100	38.9	320.0	235,200	304,000	48.4	332.2	218,200	336,800	130
135	25.4	297.7	234,500	267,500	34.5	312.7	223,900	294,800	44.8	327.1	207,700	322,000	135
140	18.0	283.5	223,200	267,500	29.5	304.0	213,400	288,000	41.0	321.3	197,900	308,200	140
145					23.4	292.8	203,400	284,300	36.8	314.6	188,800	295,400	145
150					14.8	276.3	193,800	278,100	32.1	306.6	180,200	283,600	150
155									26.7	296.9	172,100	272,400	155
160									19.7	283.9	164,300	261,900	160
165									6.5	257.9	156,300	248,200	165
170													170
175													175
180													180
185													185
190													190
195													195
200													200
205													205
210													210
215													215
220													220

# MLC650 VPC-MAX S-2

ASME B30.5

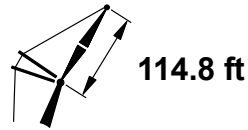
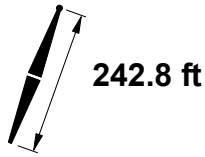
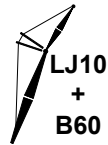

ft	75°				70°				65°				ft
	ft	°	ft	lb	ft	°	ft	lb	ft	°	ft	lb	
65													65
70													70
75													75
80													80
85													85
90													90
95													95
100													100
105													105
110													110
115													115
120													120
125	64.2	345.9	199,800	330,400									125
130	61.4	343.1	189,800	315,200									130
135	58.4	339.9	180,600	301,300									135
140	55.4	336.4	172,000	288,300									140
145	52.2	332.4	163,900	276,400									145
150	48.8	328.0	156,400	265,200									150
155	45.3	322.9	149,400	254,800	58.5	333.4	126,500	237,500					155
160	41.5	317.2	142,800	245,100	55.5	329.9	120,700	228,400					160
165	37.4	310.6	136,500	236,000	52.3	325.9	115,300	219,800					165
170	32.8	302.9	130,500	227,300	48.9	321.5	110,200	211,800					170
175	27.5	293.5	124,800	219,200	45.4	316.5	105,300	204,200					175
180	20.8	281.1	119,300	211,400	41.6	310.8	100,700	197,100					180
185	9.7	259.5	113,500	203,900	37.5	304.2	96,200	190,300	52.0	317.1	78,000	176,500	185
190					33.0	296.5	92,000	183,900	48.6	312.6	74,500	170,600	190
195					27.7	287.2	87,900	177,700	45.1	307.5	71,000	164,900	195
200					21.0	274.9	83,800	171,800	41.3	301.8	67,700	159,500	200
205					10.3	254.0	79,600	166,000	37.1	295.1	64,600	154,400	205
210									32.5	287.3	61,500	149,400	210
215									27.1	277.7	58,500	144,700	215
220									20.3	265.0	55,400	140,100	220

# MLC650 VPC-MAX S-2

ASME B30.5

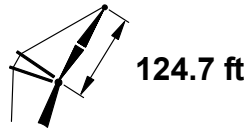
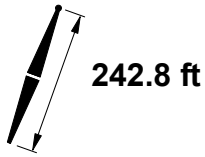

ft	85°				83°				80°				ft
	ft	lb	lb	lb	ft	lb	lb	lb	ft	lb	lb	lb	
70	73.0	370.3	385,300 b	385,300 b									70
75	70.6	368.5	383,500 b	383,500 b									75
80	68.1	366.4	380,500 b	380,500 b	72.3	368.8	387,700 b	387,700 b					80
85	65.6	364.0	376,700 b	376,700 b	69.8	366.8	387,500 b	387,500 b					85
90	63.0	361.4	372,000	372,000	67.3	364.7	370,700 b	386,000 b					90
95	60.3	358.5	359,200	359,200	64.8	362.2	347,400	383,300					95
100	57.6	355.2	339,800	339,800	62.2	359.5	326,500	379,900	68.6	363.8	303,300	387,600	100
105	54.7	351.6	322,400	322,600	59.5	356.5	307,700	375,700	66.1	361.5	285,700	387,600	105
110	51.8	347.6	304,700	307,200	56.7	353.1	290,700	363,900	63.5	358.9	269,800	387,600	110
115	48.7	343.1	288,500	293,800	53.8	349.4	275,100	345,100	60.9	356.0	255,300	387,200	115
120	45.5	338.1	273,600	282,000	50.8	345.2	260,900	328,400	58.1	352.8	242,000	370,100	120
125	42.0	332.5	260,000	271,700	47.7	340.6	247,900	313,800	55.3	349.3	229,800	352,700	125
130	38.3	326.1	247,400	263,200	44.4	335.4	235,800	300,900	52.4	345.4	218,500	336,600	130
135	34.2	318.8	235,700	256,300	40.9	329.6	224,700	289,800	49.3	341.0	208,100	321,800	135
140	29.6	310.1	224,700	251,500	37.1	322.9	214,300	280,600	46.1	336.1	198,400	308,200	140
145	24.1	299.2	214,500	246,400	32.8	315.2	204,600	273,100	42.7	330.6	189,400	295,500	145
150	16.9	284.3	204,700	245,000	28.0	306.0	195,400	267,900	39.1	324.4	181,000	283,600	150
155					22.1	294.2	186,800	262,400	35.1	317.3	173,000	272,600	155
160					13.7	276.6	178,300	253,300	30.6	308.9	165,500	262,300	160
165									25.3	298.6	158,400	252,600	165
170									18.6	284.8	151,500	243,400	170
175									4.9	255.6	144,300	226,000	175
180													180
185													185
190													190
195													195
200													200
205													205
210													210
215													215
220													220
230													230



# MLC650 VPC-MAX S-2

ASME B30.5

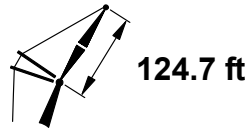
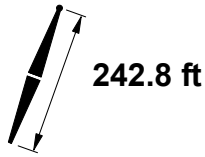

ft	75°				70°				65°				ft
	ft	°	ft	lb	ft	°	ft	lb	ft	°	ft	lb	
70													70
75													75
80													80
85													85
90													90
95													95
100													100
105													105
110													110
115													115
120													120
125													125
130	63.9	354.4	189,900	314,900									130
135	61.2	351.6	180,600	301,000									135
140	58.5	348.4	172,100	288,100									140
145	55.7	344.9	164,100	276,200									145
150	52.8	341.0	156,700	265,100									150
155	49.8	336.7	149,700	254,800									155
160	46.6	331.9	143,100	245,100	58.6	341.9	120,800	228,200					160
165	43.2	326.5	137,000	236,000	55.8	338.4	115,400	219,700					165
170	39.6	320.4	131,100	227,500	52.9	334.5	110,300	211,700					170
175	35.6	313.4	125,600	219,400	49.9	330.2	105,500	204,200					175
180	31.2	305.2	120,300	211,800	46.7	325.4	101,000	197,100					180
185	26.1	295.3	115,200	204,600	43.3	320.1	96,600	190,400					185
190	19.6	282.1	110,200	197,700	39.7	314.0	92,500	184,000	52.6	325.7	74,600	170,500	190
195	8.6	258.8	105,000	190,900	35.8	307.0	88,500	178,000	49.6	321.4	71,200	164,900	195
200					31.4	298.9	84,700	172,200	46.4	316.6	68,000	159,500	200
205					26.3	289.0	81,000	166,700	43.0	311.1	64,900	154,400	205
210					19.9	276.0	77,300	161,400	39.3	305.0	61,900	149,600	210
215					9.3	253.4	73,400	156,100	35.3	297.9	59,000	144,900	215
220									30.9	289.6	56,200	140,500	220
230									19.1	266.0	50,700	132,000	230

# MLC650 VPC-MAX S-2

ASME B30.5

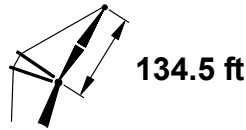
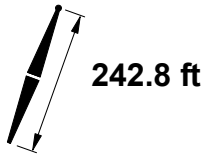

ft	85°				83°				80°				ft
	ft	ft	lb	lb	ft	lb	lb	ft	lb	lb			
70	74.3	380.7	359,500 b	359,500 b								70	
75	72.1	379.0	358,800 b	358,800 b								75	
80	69.8	377.1	356,800 b	356,800 b								80	
85	67.5	374.9	354,000	354,000	71.4	377.4	361,300 b	361,300 b				85	
90	65.1	372.5	350,500	350,500	69.1	375.4	360,900	360,900				90	
95	62.7	369.9	346,500	346,500	66.8	373.2	344,600	359,400				95	
100	60.3	366.9	336,400	336,400	64.4	370.7	323,800	357,000				100	
105	57.7	363.7	319,100	319,100	62.0	368.0	305,100	354,100	68.0	372.3	282,700	361,200	105
110	55.1	360.1	302,300	303,600	59.5	365.0	288,100	350,600	65.6	370.0	266,800	361,200	110
115	52.4	356.2	286,200	289,700	56.9	361.6	272,600	343,200	63.2	367.4	252,300	361,200	115
120	49.6	351.9	271,400	277,400	54.3	357.9	258,500	326,200	60.8	364.5	239,100	360,900	120
125	46.6	347.1	257,800	266,400	51.5	353.9	245,500	311,000	58.2	361.3	227,000	350,100	125
130	43.5	341.8	245,300	256,800	48.7	349.4	233,500	297,500	55.6	357.8	215,800	334,200	130
135	40.2	335.8	233,700	248,600	45.7	344.5	222,400	285,500	52.9	354.0	205,400	319,400	135
140	36.6	329.0	222,900	240,700	42.5	339.0	212,100	275,000	50.2	349.7	195,800	305,800	140
145	32.7	321.3	212,800	232,700	39.1	332.8	202,500	266,000	47.2	345.0	186,900	293,200	145
150	28.2	312.1	203,400	226,100	35.4	325.7	193,500	257,200	44.2	339.8	178,500	281,500	150
155	22.9	300.7	194,400	221,900	31.4	317.6	185,000	248,600	40.9	334.0	170,700	270,500	155
160	15.9	284.9	185,800	221,200	26.7	307.8	177,000	241,600	37.4	327.4	163,300	260,200	160
165					21.0	295.4	169,400	237,100	33.5	319.9	156,300	250,600	165
170					12.8	276.8	161,900	233,800	29.2	311.0	149,700	241,500	170
175									24.1	300.2	143,400	233,000	175
180									17.6	285.6	137,300	224,800	180
185													185
190													190
195													195
200													200
205													205
210													210
215													215
220													220
230													230
240													240

# MLC650 VPC-MAX S-2

ASME B30.5

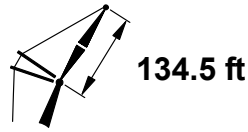
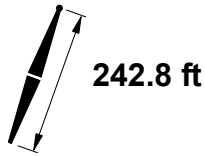

ft	75°				70°				65°				ft
	ft	ft	lb	lb	ft	ft	lb	lb	ft	ft	lb	lb	
70													70
75													75
80													80
85													85
90													90
95													95
100													100
105													105
110													110
115													115
120													120
125													125
130													130
135	63.5	362.9	177,400	298,200									135
140	61.1	360.0	168,900	285,400									140
145	58.6	356.9	161,000	273,600									145
150	56.0	353.5	153,600	262,600									150
155	53.3	349.7	146,700	252,300									155
160	50.5	345.5	140,200	242,700									160
165	47.6	340.8	134,100	233,600	58.7	350.4	112,100	217,000					165
170	44.6	335.7	128,400	225,200	56.1	346.9	107,100	209,100					170
175	41.3	330.0	122,900	217,200	53.4	343.1	102,300	201,600					175
180	37.9	323.5	117,700	209,600	50.6	339.0	97,800	194,600					180
185	34.1	316.1	112,800	202,500	47.7	334.3	93,600	187,900					185
190	29.8	307.4	108,100	195,700	44.7	329.2	89,500	181,600					190
195	24.8	296.9	103,500	189,300	41.4	323.5	85,700	175,600	53.1	334.4	67,900	162,200	195
200	18.6	283.1	99,000	183,100	38.0	317.1	82,000	170,000	50.3	330.1	64,700	156,900	200
205	7.6	257.8	94,300	177,000	34.2	309.7	78,400	164,500	47.4	325.5	61,700	151,900	205
210					30.0	301.1	75,000	159,400	44.4	320.3	58,800	147,100	210
215					25.0	290.7	71,600	154,400	41.1	314.5	56,000	142,500	215
220					18.8	277.0	68,300	149,600	37.6	308.0	53,300	138,100	220
230									29.5	291.8	48,200	129,900	230
240									18.1	266.9	43,100	122,200	240

# MLC650 VPC-MAX S-2

ASME B30.5



661,300 lb



360°

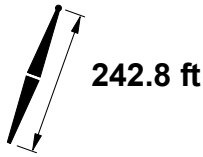

242.8 ft

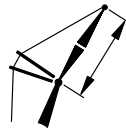

144.4 ft

ft	85°				83°				80°				ft
	ft	lb	lb	lb	ft	lb	lb	lb	ft	lb	lb	lb	
75	73.4	389.4	335,500 b	335,500 b									75
80	71.3	387.6	334,500	334,500									80
85	69.1	385.6	332,500	332,500	72.7	387.9	336,800	336,800					85
90	67.0	383.4	329,900	329,900	70.6	386.0	336,800	336,800					90
95	64.7	381.0	326,800	326,800	68.4	384.0	336,600	336,600					95
100	62.5	378.3	322,900	322,900	66.3	381.7	321,900	335,200					100
105	60.2	375.4	313,600	313,600	64.0	379.2	303,200	333,100	69.6	383.0	280,600	335,100	105
110	57.8	372.2	300,700	300,700	61.8	376.5	286,300	330,500	67.4	380.9	264,800	335,100	110
115	55.4	368.7	284,600	286,600	59.5	373.4	270,800	327,500	65.2	378.5	250,400	335,100	115
120	52.9	364.8	269,800	274,000	57.1	370.1	256,700	319,400	63.0	375.9	237,200	335,100	120
125	50.3	360.6	256,300	262,600	54.6	366.5	243,800	306,900	60.7	373.0	225,100	335,100	125
130	47.6	356.0	243,800	252,500	52.1	362.5	231,800	294,600	58.3	369.8	213,900	332,400	130
135	44.8	350.9	232,300	242,700	49.5	358.2	220,800	282,500	55.9	366.4	203,600	317,700	135
140	41.8	345.2	221,600	233,000	46.7	353.4	210,500	270,900	53.4	362.6	194,000	304,100	140
145	38.6	338.9	211,600	224,200	43.9	348.2	201,000	260,000	50.8	358.4	185,100	291,500	145
150	35.1	331.8	202,200	216,300	40.8	342.3	192,100	249,700	48.2	353.9	176,800	279,800	150
155	31.3	323.6	193,400	209,600	37.5	335.8	183,700	240,300	45.4	348.9	169,000	268,900	155
160	27.0	314.0	185,200	204,300	34.0	328.4	175,800	231,900	42.4	343.4	161,700	258,700	160
165	21.9	302.1	177,300	200,900	30.1	319.8	168,400	224,600	39.3	337.2	154,900	249,100	165
170	15.0	285.4	169,700	200,900	25.5	309.6	161,300	218,900	35.9	330.3	148,400	240,100	170
175					20.0	296.6	154,600	215,300	32.1	322.4	142,200	231,600	175
180					11.9	276.8	147,900	215,300	28.0	313.1	136,300	223,600	180
185									23.0	301.7	130,700	216,000	185
190									16.6	286.4	125,200	208,800	190
195													195
200													200
205													205
210													210
215													215
220													220
230													230
240													240
250													250

# MLC650 VPC-MAX S-2

ASME B30.5

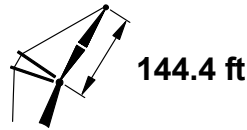
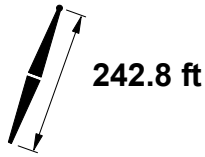

ft	75°				70°				65°				ft
	ft	°	ft	lb	ft	°	ft	lb	ft	°	ft	lb	
75													75
80													80
85													85
90													90
95													95
100													100
105													105
110													110
115													115
120													120
125													125
130													130
135													135
140	63.3	371.4	166,800	283,600									140
145	61.0	368.5	158,900	271,700									145
150	58.6	365.4	151,600	260,800									150
155	56.2	362.0	144,700	250,500									155
160	53.8	358.2	138,300	240,900									160
165	51.2	354.1	132,200	232,000									165
170	48.5	349.7	126,500	223,500	58.7	358.8	104,900	207,300					170
175	45.7	344.7	121,100	215,600	56.3	355.4	100,200	199,800					175
180	42.8	339.3	116,000	208,100	53.8	351.7	95,800	192,800					180
185	39.7	333.2	111,200	201,000	51.3	347.6	91,600	186,200					185
190	36.3	326.4	106,500	194,300	48.6	343.2	87,600	180,000					190
195	32.7	318.6	102,100	187,900	45.8	338.2	83,700	174,000					195
200	28.5	309.5	97,800	181,900	42.9	332.8	80,100	168,400	53.6	342.9	62,600	155,200	200
205	23.7	298.5	93,700	176,100	39.8	326.8	76,600	163,000	51.0	338.8	59,600	150,200	205
210	17.6	283.9	89,700	170,500	36.4	320.0	73,300	157,900	48.3	334.3	56,700	145,400	210
215	6.5	256.4	85,300	165,000	32.8	312.2	70,100	153,000	45.6	329.4	54,000	140,900	215
220					28.7	303.2	66,900	148,300	42.6	323.9	51,400	136,600	220
230					17.9	277.8	60,800	139,400	36.1	310.9	46,400	128,400	230
240									28.3	293.8	41,700	120,900	240
250									17.1	267.7	37,100	113,800	250

# MLC650 VPC-MAX S-2

ASME B30.5



661,300 lb



360°

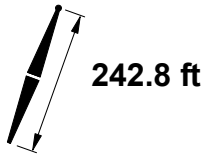

242.8 ft

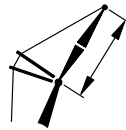

154.2 ft

ft	85°				83°				80°				ft
	ft	lb	lb	lb	ft	lb	lb	lb	ft	lb	lb	lb	
75	74.5	399.7	313,400 b	313,400 b									75
80	72.5	398.1	313,100	313,100									80
85	70.5	396.2	311,900	311,900									85
90	68.5	394.2	310,000	310,000	71.9	396.5	314,500	314,500					90
95	66.5	392.0	307,700	307,700	69.9	394.6	314,500	314,500					95
100	64.4	389.5	304,400	304,400	67.9	392.5	314,000	314,000					100
105	62.3	386.8	301,400	301,400	65.8	390.2	300,500	312,700					105
110	60.2	383.9	290,500	290,500	63.8	387.7	283,600	310,900	68.9	391.6	261,800	312,800	110
115	57.9	380.7	279,000	279,000	61.6	384.9	268,200	308,700	66.9	389.4	247,400	312,800	115
120	55.7	377.2	267,500	267,700	59.5	381.9	254,200	306,100	64.8	387.0	234,300	312,800	120
125	53.4	373.4	254,000	256,700	57.2	378.6	241,200	297,100	62.7	384.3	222,200	312,800	125
130	50.9	369.3	241,600	246,100	55.0	375.1	229,400	285,800	60.6	381.5	211,100	312,800	130
135	48.4	364.8	230,100	236,000	52.6	371.2	218,300	274,700	58.4	378.3	200,800	312,800	135
140	45.8	359.9	219,400	226,400	50.2	366.9	208,100	263,800	56.1	374.9	191,300	301,800	140
145	43.1	354.5	209,500	217,400	47.6	362.3	198,600	253,300	53.8	371.2	182,500	289,200	145
150	40.2	348.5	200,200	209,200	45.0	357.3	189,800	243,300	51.4	367.1	174,200	277,600	150
155	37.1	341.9	191,500	201,700	42.2	351.7	181,500	233,800	49.0	362.7	166,500	266,700	155
160	33.8	334.5	183,300	195,100	39.3	345.5	173,700	225,000	46.4	357.9	159,200	256,500	160
165	30.1	325.9	175,600	189,500	36.1	338.7	166,300	217,000	43.7	352.6	152,400	247,000	165
170	25.9	315.8	168,300	185,100	32.7	330.9	159,400	209,900	40.8	346.7	146,000	238,000	170
175	20.9	303.3	161,300	182,600	28.9	321.9	152,800	203,700	37.8	340.3	139,900	229,600	175
180	14.2	285.8	154,500	182,600	24.5	311.2	146,500	199,000	34.5	333.0	134,100	221,700	180
185					19.1	297.6	140,500	196,300	30.9	324.7	128,600	214,100	185
190					11.1	276.7	134,500	196,300	26.8	315.0	123,400	207,000	190
195									22.0	303.1	118,300	200,200	195
200									15.8	287.0	113,300	193,700	200
205													205
210													210
215													215
220													220
230													230
240													240
250													250
260													260

# MLC650 VPC-MAX S-2

ASME B30.5

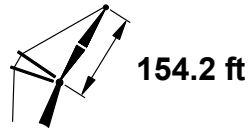
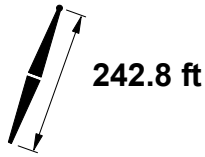
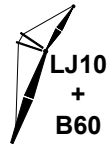

ft	75°				70°				65°				ft
	ft	°	ft	lb	ft	°	ft	lb	ft	°	ft	lb	
75													75
80													80
85													85
90													90
95													95
100													100
105													105
110													110
115													115
120													120
125													125
130													130
135													135
140													140
145	63.0	379.8	155,800	269,100									145
150	60.9	377.0	148,500	258,200									150
155	58.7	373.9	141,700	248,000									155
160	56.4	370.5	135,300	238,500									160
165	54.1	366.8	129,300	229,500									165
170	51.8	362.8	123,600	221,100									170
175	49.3	358.4	118,300	213,300	58.8	367.3	97,000	197,200					175
180	46.7	353.7	113,200	205,800	56.5	364.0	92,600	190,300					180
185	44.0	348.4	108,400	198,800	54.2	360.3	88,400	183,700					185
190	41.2	342.7	103,900	192,100	51.8	356.3	84,500	177,500					190
195	38.2	336.3	99,500	185,800	49.4	351.9	80,700	171,600					195
200	35.0	329.1	95,400	179,800	46.8	347.2	77,100	166,000	54.0	351.5	56,300	147,600	200
205	31.4	321.0	91,400	174,100	44.1	342.0	73,700	160,700	51.6	347.5	53,500	142,900	205
210	27.4	311.5	87,500	168,600	41.3	336.2	70,400	155,600	49.1	343.1	50,800	138,400	210
215	22.7	300.0	83,800	163,400	38.3	329.9	67,300	150,800	46.6	338.3	48,200	134,100	215
220	16.8	284.7	80,100	158,300	35.1	322.7	64,200	146,100	41.0	327.3	43,400	126,100	220
230					27.6	305.2	58,500	137,500	34.7	313.6	38,900	118,600	230
240					17.0	278.6	52,900	129,300	27.1	295.8	34,600	111,800	240
250									16.3	268.4	30,300	105,300	250
260													260

# MLC650 VPC-MAX S-2

ASME B30.5

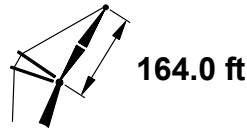
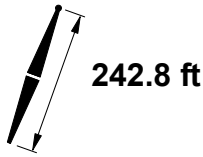

ft	85°				83°				80°				ft
	ft	lb	lb	lb	ft	lb	lb	lb	ft	lb	lb	lb	
80	73.6	408.5	293,100	293,100									80
85	71.7	406.7	292,500	292,500									85
90	69.9	404.9	291,300	291,300									90
95	68.0	402.8	289,600	289,600	71.2	405.2	294,000	294,000					95
100	66.1	400.5	287,200	287,200	69.3	403.2	293,900	293,900					100
105	64.1	398.0	284,500	284,500	67.4	401.1	293,300	293,300					105
110	62.1	395.3	280,300	280,300	65.5	398.7	282,900	292,100					110
115	60.1	392.4	270,000	270,000	63.5	396.2	267,600	290,500	68.4	400.2	246,500	292,100	115
120	58.0	389.2	259,700	259,700	61.5	393.4	253,500	288,600	66.5	397.9	233,400	292,100	120
125	55.9	385.7	249,500	249,500	59.5	390.4	240,600	286,200	64.5	395.5	221,400	292,100	125
130	53.7	382.0	239,500	239,500	57.4	387.1	228,800	277,200	62.5	392.8	210,300	292,100	130
135	51.5	378.0	229,700	229,900	55.2	383.6	217,800	267,100	60.5	389.9	200,100	292,100	135
140	49.2	373.6	219,000	220,600	53.0	379.8	207,600	257,000	58.5	386.8	190,600	292,100	140
145	46.8	368.8	209,100	211,800	50.8	375.6	198,100	247,100	56.4	383.4	181,800	288,400	145
150	44.3	363.6	199,900	203,500	48.4	371.1	189,300	237,500	54.2	379.7	173,500	276,800	150
155	41.6	358.0	191,200	195,800	46.0	366.3	181,100	228,200	52.0	375.8	165,800	265,900	155
160	38.8	351.7	183,100	188,700	43.4	360.9	173,300	219,400	49.7	371.5	158,600	255,800	160
165	35.8	344.8	175,500	182,300	40.8	355.1	166,000	211,200	47.3	366.8	151,800	246,300	165
170	32.6	337.0	168,300	176,700	37.9	348.6	159,100	203,600	44.8	361.7	145,500	237,400	170
175	29.0	328.0	161,400	171,900	34.8	341.4	152,600	196,600	42.2	356.1	139,400	229,000	175
180	25.0	317.5	154,900	168,200	31.5	333.3	146,500	190,500	39.4	350.0	133,700	221,100	180
185	20.1	304.5	148,700	166,100	27.8	324.0	140,600	185,200	36.5	343.2	128,300	213,600	185
190	13.4	286.1	142,500	166,100	23.5	312.8	135,000	181,200	33.3	335.6	123,100	206,500	190
195					18.3	298.6	129,500	178,900	29.8	326.9	118,200	199,800	195
200					10.4	276.5	124,100	178,900	25.8	316.8	113,400	193,400	200
205									21.2	304.4	108,900	187,300	205
210									15.0	287.5	104,400	181,400	210
215													215
220													220
230													230
240													240
250													250
260													260
270													270



# MLC650 VPC-MAX S-2

ASME B30.5

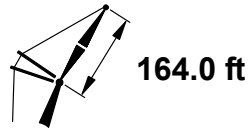
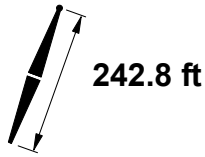

ft	75°				70°				65°				ft
	ft	°	ft	lb	ft	°	ft	lb	ft	°	ft	lb	
80													80
85													85
90													90
95													95
100													100
105													105
110													110
115													115
120													120
125													125
130													130
135													135
140													140
145	64.8	390.9	154,800	268,100									145
150	62.8	388.3	147,500	257,200									150
155	60.8	385.5	140,800	247,100									155
160	58.7	382.4	134,400	237,600									160
165	56.6	379.0	128,400	228,700									165
170	54.5	375.4	122,800	220,300									170
175	52.3	371.4	117,500	212,500									175
180	50.0	367.2	112,500	205,000	58.8	375.8	91,600	189,400					180
185	47.6	362.6	107,700	198,000	56.7	372.5	87,400	182,800					185
190	45.1	357.5	103,200	191,400	54.5	368.8	83,500	176,600					190
195	42.5	352.0	98,900	185,100	52.3	364.9	79,800	170,800					195
200	39.8	346.0	94,800	179,200	50.0	360.7	76,300	165,200					200
205	36.9	339.3	90,900	173,500	47.7	356.1	72,900	159,900					205
210	33.7	331.8	87,100	168,100	45.2	351.0	69,600	154,900	54.3	360.1	52,500	142,000	210
215	30.3	323.3	83,500	162,900	42.6	345.5	66,500	150,100	52.1	356.1	49,800	137,500	215
220	26.4	313.4	80,000	158,000	39.9	339.5	63,600	145,500	49.8	351.8	47,300	133,300	220
230	16.0	285.3	73,200	148,600	33.8	325.4	57,900	136,900	44.9	342.1	42,500	125,300	230
240					26.5	307.1	52,700	129,000	39.6	330.5	38,100	118,000	240
250					16.2	279.3	47,500	121,500	33.5	316.2	34,000	111,200	250
260									26.1	297.6	30,000	104,900	260
270									15.5	269.0	26,000	98,900	270

# MLC650 VPC-MAX S-2

ASME B30.5



661,300 lb



360°

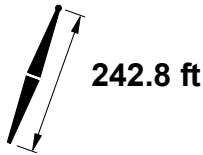

242.8 ft

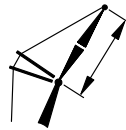

173.9 ft

ft	85°				83°				80°				ft
	ft	lb	lb	lb	ft	lb	lb	lb	ft	lb	lb	lb	
80	74.6	418.8	272,900	272,900									80
85	72.8	417.2	272,900	272,900									85
90	71.1	415.4	272,200	272,200									90
95	69.3	413.4	271,100	271,100	72.3	415.6	273,300	273,300					95
100	67.5	411.3	269,600	269,600	70.5	413.8	273,300	273,300					100
105	65.7	409.0	267,700	267,700	68.7	411.8	273,300	273,300					105
110	63.9	406.5	265,200	265,200	67.0	409.6	273,000	273,000					110
115	62.0	403.8	260,700	260,700	65.1	407.2	264,900	272,000	69.7	410.8	243,500	270,200	115
120	60.1	400.8	251,500	251,500	63.3	404.7	250,900	270,600	67.9	408.7	230,500	270,200	120
125	58.1	397.7	242,300	242,300	61.4	401.9	238,000	269,100	66.1	406.4	218,500	270,200	125
130	56.1	394.3	233,100	233,100	59.5	398.9	226,200	267,200	64.2	404.0	207,500	270,200	130
135	54.1	390.6	224,100	224,100	57.5	395.6	215,300	259,200	62.4	401.3	197,300	270,200	135
140	52.0	386.6	215,400	215,400	55.5	392.1	205,100	250,100	60.5	398.4	187,800	270,200	140
145	49.8	382.3	206,900	207,000	53.4	388.4	195,700	241,000	58.5	395.3	179,000	270,200	145
150	47.6	377.7	197,700	199,000	51.3	384.3	186,900	232,100	56.5	391.9	170,800	270,200	150
155	45.2	372.7	189,100	191,400	49.1	379.9	178,700	223,400	54.5	388.3	163,200	263,700	155
160	42.8	367.2	181,000	184,200	46.8	375.2	171,000	215,000	52.4	384.4	156,000	253,600	160
165	40.2	361.3	173,400	177,600	44.5	370.0	163,700	206,900	50.3	380.2	149,300	244,100	165
170	37.5	354.8	166,200	171,500	42.0	364.4	156,900	199,300	48.0	375.6	142,900	235,200	170
175	34.6	347.5	159,500	166,000	39.4	358.3	150,400	192,100	45.7	370.7	136,900	226,900	175
180	31.5	339.4	153,100	161,100	36.6	351.6	144,300	185,500	43.3	365.3	131,200	219,000	180
185	28.0	330.1	147,000	157,100	33.7	344.1	138,500	179,500	40.8	359.5	125,900	211,600	185
190	24.0	319.2	141,100	154,100	30.4	335.6	133,000	174,200	38.1	353.1	120,800	204,500	190
195	19.3	305.6	135,500	152,500	26.8	325.9	127,700	169,700	35.2	346.0	115,900	197,800	195
200	12.7	286.3	130,000	152,500	22.7	314.3	122,700	166,300	32.1	338.1	111,300	191,500	200
205					17.5	299.4	117,700	164,500	28.7	329.0	106,800	185,500	205
210					9.7	276.1	112,800	164,500	24.9	318.5	102,500	179,700	210
215									20.3	305.6	98,400	174,200	215
220									14.3	288.0	94,200	168,800	220
230													230
240													240
250													250
260													260
270													270
280													280

# MLC650 VPC-MAX S-2

ASME B30.5

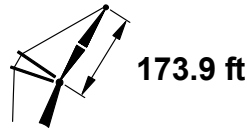
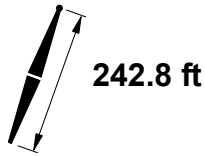

ft	75°				70°				65°				ft
	ft	°	ft	lb	ft	°	ft	lb	ft	°	ft	lb	
80													80
85													85
90													90
95													95
100													100
105													105
110													110
115													115
120													120
125													125
130													130
135													135
140													140
145													145
150	64.5	399.4	144,400	254,600									150
155	62.6	396.8	137,700	244,500									155
160	60.7	393.9	131,300	235,100									160
165	58.8	390.8	125,400	226,200									165
170	56.8	387.5	119,800	217,900									170
175	54.8	383.9	114,600	210,100									175
180	52.7	380.1	109,600	202,700									180
185	50.5	375.9	104,900	195,700	58.8	384.3	84,200	180,300					185
190	48.3	371.4	100,400	189,200	56.9	381.0	80,400	174,100					190
195	46.0	366.5	96,100	182,900	54.8	377.4	76,700	168,300					195
200	43.6	361.2	92,100	177,000	52.8	373.5	73,200	162,800					200
205	41.1	355.4	88,200	171,400	50.6	369.4	69,800	157,500					205
210	38.5	349.1	84,500	166,000	48.4	364.9	66,600	152,500					210
215	35.6	342.1	81,000	160,900	46.1	360.0	63,600	147,700	54.6	368.6	46,500	135,000	215
220	32.6	334.3	77,600	156,000	43.7	354.7	60,700	143,200	52.6	364.8	44,000	130,800	220
230	25.4	315.1	71,100	146,800	38.5	342.7	55,200	134,700	48.2	356.0	39,400	122,800	230
240	15.3	285.9	64,900	138,200	32.7	327.9	50,000	126,800	43.5	345.8	35,000	115,600	240
250					25.6	308.8	45,200	119,600	38.3	333.6	31,000	108,900	250
260					15.5	279.9	40,400	112,800	32.4	318.7	27,200	102,700	260
270									25.2	299.4	23,600	96,900	270
280									14.8	269.5	21,300	91,300	280

# MLC650 VPC-MAX S-2

ASME B30.5



661,300 lb

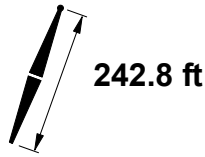

242.8 ft

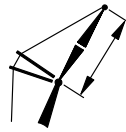

193.6 ft

ft	85°				83°				80°				ft
	ft	lb	lb	lb	ft	lb	lb	lb	ft	lb	lb	lb	
85	74.6	437.8	239,100	239,100									85
90	73.1	436.2	239,100	239,100									90
95	71.5	434.5	238,800	238,800									95
100	69.9	432.6	238,100	238,100	72.6	434.7	238,800	238,800					100
105	68.3	430.6	237,100	237,100	71.0	433.0	238,800	238,800					105
110	66.7	428.4	235,800	235,800	69.4	431.0	238,800	238,800					110
115	65.1	426.0	234,200	234,200	67.8	428.9	238,800	238,800					115
120	63.4	423.5	232,200	232,200	66.2	426.7	238,600	238,600					120
125	61.7	420.7	226,300	226,300	64.6	424.2	234,700	237,800	68.7	428.0	214,600	236,100	125
130	60.0	417.8	218,800	218,800	62.9	421.6	222,900	236,800	67.0	425.8	203,700	236,100	130
135	58.3	414.6	211,300	211,300	61.2	418.8	212,000	235,700	65.4	423.5	193,500	236,100	135
140	56.5	411.3	203,800	203,800	59.5	415.8	201,900	234,300	63.8	421.0	184,100	236,100	140
145	54.7	407.7	196,500	196,500	57.7	412.6	192,500	227,000	62.1	418.2	175,400	236,100	145
150	52.8	403.8	189,200	189,200	55.9	409.2	183,700	219,600	60.4	415.3	167,300	236,100	150
155	50.9	399.7	182,300	182,300	54.1	405.5	175,600	212,200	58.6	412.2	159,700	236,100	155
160	48.9	395.3	175,500	175,500	52.2	401.6	167,900	204,800	56.8	408.9	152,500	236,100	160
165	46.9	390.6	169,100	169,100	50.3	397.4	160,700	197,600	55.0	405.4	145,800	236,100	165
170	44.7	385.5	163,000	163,000	48.3	392.9	154,000	190,500	53.2	401.6	139,500	232,300	170
175	42.6	380.0	156,900	157,200	46.2	388.0	147,600	183,700	51.3	397.5	133,600	224,000	175
180	40.3	374.0	150,600	151,800	44.1	382.8	141,500	177,200	49.3	393.2	128,000	216,200	180
185	37.8	367.6	144,600	146,800	41.8	377.2	135,800	171,000	47.3	388.5	122,700	208,800	185
190	35.3	360.5	138,900	142,200	39.5	371.1	130,400	165,100	45.2	383.5	117,700	201,800	190
195	32.5	352.7	133,500	138,100	37.1	364.4	125,200	159,700	43.0	378.1	112,900	195,200	195
200	29.5	343.9	128,300	134,600	34.4	357.1	120,300	154,700	40.7	372.2	108,300	188,900	200
205	26.2	333.9	123,400	131,700	31.6	349.0	115,600	150,100	38.3	365.9	104,000	182,900	205
210	22.4	322.2	118,600	129,600	28.5	339.9	111,100	146,100	35.8	358.9	99,800	177,200	210
215	17.9	307.5	114,000	128,700	25.1	329.5	106,800	142,800	33.1	351.3	95,900	171,800	215
220	11.4	286.4	109,400	128,700	21.1	317.0	102,600	140,400	30.2	342.7	92,000	166,600	220
230					8.3	275.0	94,300	138,400	23.3	321.7	84,800	156,900	230
240									13.0	288.6	77,800	147,800	240
250													250
260													260
270													270
280													280
290													290
300													300

# MLC650 VPC-MAX S-2

ASME B30.5

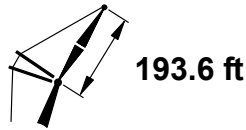
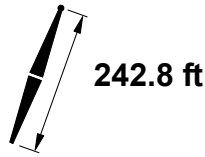

ft	75°				70°				65°			ft
	ft	ft	lb	lb	ft	ft	lb	lb	ft	lb		
85												85
90												90
95												95
100												100
105												105
110												110
115												115
120												120
125												125
130												130
135												135
140												140
145												145
150												150
155												155
160	64.0	416.4	127,200	225,600								160
165	62.3	413.8	121,400	222,800								165
170	60.6	410.9	115,800	214,500								170
175	58.9	407.8	110,600	206,800								175
180	57.1	404.5	105,700	199,500								180
185	55.3	401.0	101,100	192,600								185
190	53.4	397.2	96,700	186,000								190
195	51.5	393.2	92,500	179,800	58.9	401.3	72,400	164,900				195
200	49.6	388.9	88,500	174,000	57.1	398.0	69,000	159,400				200
205	47.6	384.3	84,700	168,400	55.3	394.5	65,700	154,200				205
210	45.5	379.3	81,100	163,100	53.5	390.7	62,600	149,200				210
215	43.3	374.0	77,600	158,000	51.6	386.7	59,600	144,500				215
220	41.0	368.2	74,300	153,200	49.6	382.4	56,700	140,000				220
230	36.1	355.0	68,100	144,100	45.5	372.8	51,400	131,600	53.3	381.9	119,500	230
240	30.6	339.1	62,300	135,800	41.1	361.7	46,400	123,900	49.4	373.6	112,300	240
250	23.8	318.4	56,800	128,200	36.2	348.6	41,800	116,800	45.3	363.9	105,700	250
260	14.0	286.8	51,500	120,900	30.7	332.7	37,500	110,200	40.9	352.7	99,600	260
270					23.9	312.2	33,400	104,100	36.0	339.5	94,000	270
280					14.2	280.9	29,300	98,200	30.4	323.4	88,700	280
290									23.5	302.6	83,700	290
300									13.5	270.3	78,900	300

# MLC650 VPC-MAX S-2

ASME B30.5



661,300 lb

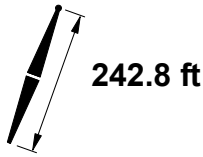

242.8 ft

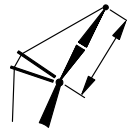

213.3 ft

ft	85°				83°				80°				ft
	ft	lb	lb	lb	ft	lb	lb	lb	ft	lb	lb	lb	
90	74.7	456.9	209,700	209,700									90
95	73.3	455.3	209,700	209,700									95
100	71.9	453.6	209,500	209,500									100
105	70.4	451.8	208,700	208,700	72.8	453.8	209,000	209,000					105
110	69.0	449.8	207,800	207,800	71.4	452.1	209,000	209,000					110
115	67.5	447.7	206,700	206,700	70.0	450.2	209,000	209,000					115
120	66.1	445.5	205,400	205,400	68.5	448.2	209,000	209,000					120
125	64.6	443.0	204,100	204,100	67.1	446.0	209,000	209,000					125
130	63.1	440.4	202,500	202,500	65.6	443.7	208,700	208,700	69.3	447.2	199,900	205,800	130
135	61.5	437.7	196,800	196,800	64.1	441.2	208,000	208,000	67.8	445.1	189,800	205,800	135
140	60.0	434.7	190,800	190,800	62.6	438.6	198,600	207,000	66.4	442.9	180,400	205,800	140
145	58.4	431.6	184,500	184,500	61.0	435.8	189,200	206,000	64.9	440.5	171,700	205,800	145
150	56.8	428.3	178,400	178,400	59.5	432.8	180,500	204,600	63.4	437.9	163,600	205,800	150
155	55.1	424.8	172,400	172,400	57.9	429.6	172,400	199,000	61.8	435.2	156,100	205,800	155
160	53.4	421.0	166,500	166,500	56.3	426.2	164,700	193,000	60.3	432.3	149,000	205,800	160
165	51.7	417.0	160,700	160,700	54.6	422.6	157,600	186,900	58.7	429.2	142,300	205,800	165
170	50.0	412.8	155,100	155,100	52.9	418.8	150,900	180,900	57.1	425.9	136,100	205,800	170
175	48.1	408.2	149,700	149,700	51.2	414.7	144,500	174,900	55.5	422.4	130,200	205,800	175
180	46.3	403.4	144,500	144,500	49.4	410.4	138,500	169,100	53.8	418.7	124,600	205,800	180
185	44.4	398.2	139,600	139,600	47.6	405.8	132,900	163,300	52.1	414.8	119,400	201,800	185
190	42.3	392.7	134,900	134,900	45.7	400.8	127,500	157,900	50.3	410.6	114,400	195,900	190
195	40.3	386.8	130,500	130,500	43.7	395.6	122,400	152,600	48.5	406.1	109,600	190,000	195
200	38.1	380.4	125,800	126,400	41.7	389.9	117,500	147,500	46.7	401.4	105,100	184,100	200
205	35.8	373.4	121,000	122,600	39.6	383.8	112,900	142,800	44.7	396.3	100,900	178,300	205
210	33.3	365.8	116,300	119,200	37.4	377.3	108,500	138,200	42.8	390.8	96,800	172,600	210
215	30.7	357.5	111,900	116,100	35.0	370.1	104,300	134,000	40.7	385.0	92,900	167,200	215
220	27.9	348.1	107,600	113,400	32.5	362.3	100,200	130,100	38.5	378.7	89,100	161,800	220
230	21.1	324.9	99,500	109,800	26.9	343.9	92,600	123,700	33.8	364.4	82,100	152,100	230
240	10.3	286.2	91,700	109,400	19.8	319.4	85,500	119,500	28.5	347.0	75,600	143,500	240
250					7.1	273.3	78,300	115,800	21.8	324.5	69,500	137,100	250
260									11.9	288.9	63,500	129,800	260
270													270
280													280
290													290
300													300
310													310
320													320

# MLC650 VPC-MAX S-2

ASME B30.5

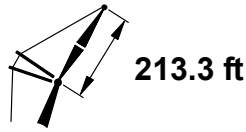
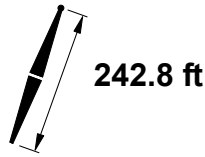

ft	75°				70°				65°				
	ft	lb	ft	lb	ft	lb	ft	lb	ft	lb	ft	lb	
90													90
95													95
100													100
105													105
110													110
115													115
120													120
125													125
130													130
135													135
140													140
145													145
150													150
155													155
160													160
165													165
170	63.6	433.4	111,800	197,100									170
175	62.0	430.7	106,700	197,100									175
180	60.5	427.8	101,800	196,200									180
185	58.9	424.8	97,200	189,300									185
190	57.3	421.5	92,800	182,800									190
195	55.7	418.0	88,700	176,700									195
200	54.0	414.4	84,700	170,900									200
205	52.3	410.5	81,000	165,300	59.0	418.2	61,500	150,800					205
210	50.6	406.3	77,400	160,100	57.4	415.0	58,500	145,900					210
215	48.8	401.9	74,000	155,100	55.7	411.5	55,500	141,300					215
220	46.9	397.1	70,800	150,300	54.1	407.8	52,700	136,800					220
230	43.0	386.7	64,600	141,300	50.6	399.8	47,500	128,500					230
240	38.8	374.7	59,000	133,100	47.0	390.7	42,600	120,900	53.9	399.1	109,000		240
250	34.2	360.6	53,800	125,600	43.1	380.2	38,200	113,900	50.4	391.0	102,500		250
260	28.9	343.5	48,900	118,600	38.9	368.2	34,000	107,400	46.8	381.8	96,500		260
270	22.3	321.4	44,200	112,100	34.3	354.2	30,100	101,400	42.9	371.3	90,900		270
280	12.8	287.4	39,600	105,900	28.9	337.1	26,400	95,700	38.7	359.2	85,700		280
290					22.5	315.2	22,800	90,500	34.0	345.0	80,900		290
300					13.0	281.5		85,400	28.7	327.8	76,300		300
310									22.1	305.5	72,000		310
320									12.4	270.7	67,800		320

# MLC650 VPC-MAX S-2

ASME B30.5



661,300 lb

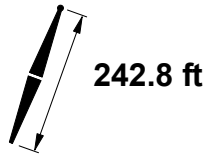

242.8 ft

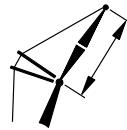

232.9 ft

ft	85°				83°				80°				ft
	ft	lb	lb	lb	ft	lb	lb	lb	ft	lb	lb	lb	
95	74.7	475.9	182,300	182,300									95
100	73.5	474.4	182,300	182,300									100
105	72.2	472.7	182,100	182,100									105
110	70.9	470.9	181,700	181,700									110
115	69.5	469.0	181,100	181,100	71.8	471.2	181,600	181,600					115
120	68.2	467.0	180,300	180,300	70.4	469.4	181,600	181,600					120
125	66.9	464.8	179,400	179,400	69.1	467.4	181,600	181,600					125
130	65.5	462.5	178,400	178,400	67.8	465.3	181,500	181,500					130
135	64.1	460.0	177,300	177,300	66.4	463.1	181,300	181,300	69.8	466.4	177,500	177,500	135
140	62.8	457.4	176,100	176,100	65.1	460.7	180,800	180,800	68.5	464.4	177,500	177,500	140
145	61.3	454.6	173,200	173,200	63.7	458.2	180,100	180,100	67.1	462.2	169,100	177,500	145
150	59.9	451.7	168,200	168,200	62.3	455.6	178,300	179,400	65.8	459.9	161,100	177,500	150
155	58.5	448.6	163,300	163,300	60.9	452.7	170,100	178,600	64.4	457.5	153,500	177,500	155
160	57.0	445.3	158,300	158,300	59.5	449.7	162,500	177,700	63.0	454.9	146,500	177,500	160
165	55.5	441.8	153,400	153,400	58.0	446.6	155,400	176,300	61.6	452.2	139,900	177,500	165
170	54.0	438.1	148,500	148,500	56.5	443.2	148,700	171,500	60.2	449.3	133,700	177,500	170
175	52.4	434.2	143,700	143,700	55.0	439.7	142,400	166,600	58.8	446.2	127,800	177,500	175
180	50.8	430.1	139,000	139,000	53.5	435.9	136,400	161,700	57.3	442.9	122,300	177,500	180
185	49.2	425.8	134,400	134,400	51.9	432.0	130,800	156,800	55.8	439.5	117,000	177,500	185
190	47.5	421.1	130,000	130,000	50.3	427.8	125,500	152,000	54.3	435.8	112,100	177,500	190
195	45.8	416.2	125,800	125,800	48.7	423.3	120,400	147,200	52.7	432.0	107,400	177,500	195
200	44.0	411.0	121,700	121,700	47.0	418.6	115,600	142,500	51.1	427.9	102,900	175,800	200
205	42.2	405.5	117,800	117,800	45.2	413.6	111,000	138,000	49.5	423.6	98,700	171,100	205
210	40.3	399.5	114,100	114,100	43.5	408.3	106,600	133,600	47.9	419.0	94,600	166,300	210
215	38.3	393.2	110,300	110,700	41.6	402.7	102,500	129,500	46.1	414.2	90,700	161,500	215
220	36.2	386.3	106,100	107,500	39.7	396.6	98,500	125,500	44.4	409.1	87,000	156,800	220
230	31.7	370.8	98,200	101,800	35.5	383.1	91,000	118,100	40.7	397.7	80,100	147,600	230
240	26.4	352.0	91,000	97,400	30.9	367.2	84,100	111,700	36.6	384.7	73,700	138,900	240
250	19.9	327.3	84,100	94,700	25.5	347.6	77,600	106,600	32.1	369.5	67,800	131,100	250
260	9.3	285.6	77,400	94,500	18.6	321.5	71,600	103,500	27.0	351.1	62,300	124,300	260
270					5.9	270.8	65,400	97,900	20.6	327.2	57,100	119,100	270
280									10.9	288.9	51,900	111,500	280
290													290
300													300
310													310
320													320
330													330
340													340



# MLC650 VPC-MAX S-2

ASME B30.5

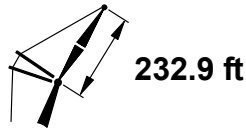
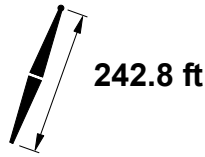

ft	75°				70°				65°				
	ft	lb	lb	lb	ft	lb	lb	lb	ft	lb	lb	ft	
95													95
100													100
105													105
110													110
115													115
120													120
125													125
130													130
135													135
140													140
145													145
150													150
155													155
160													160
165													165
170													170
175	64.6	453.0	103,800	167,600									175
180	63.2	450.4	99,000	167,600									180
185	61.8	447.7	94,400	167,600									185
190	60.4	444.8	90,100	167,600									190
195	59.0	441.7	86,000	167,600									195
200	57.5	438.5	82,100	167,600									200
205	56.0	435.1	78,400	163,100									205
210	54.5	431.5	74,800	157,900									210
215	52.9	427.6	71,500	152,900	59.0	435.2	52,600	138,800					215
220	51.4	423.6	68,200	148,100	57.5	432.0	49,800	134,400					220
230	48.1	414.8	62,200	139,300	54.5	424.9	44,600	126,200					230
240	44.6	404.9	56,700	131,100	51.4	417.1	39,900	118,600					240
250	40.9	393.7	51,500	123,700	48.1	408.3	35,500	111,700	54.4	416.2	100,100		250
260	36.9	380.8	46,800	116,800	44.7	398.4	31,400	105,300	51.3	408.3	94,100		260
270	32.5	365.7	42,300	110,300	41.0	387.2	27,600	99,300	48.0	399.5	88,700		270
280	27.4	347.5	38,100	104,400	37.0	374.3	24,100	93,800	44.5	389.5	83,500		280
290	21.1	324.1	34,100	98,800	32.5	359.3	20,700	88,700	40.8	378.2	78,800		290
300	11.8	287.7	30,100	93,400	27.5	341.2		83,800	36.8	365.3	74,300		300
310					21.2	317.9		79,200	32.3	350.1	70,100		310
320					12.0	281.9		74,800	27.2	331.8	66,100		320
330									20.9	308.2	62,400		330
340									11.4	270.9	58,700		340

# MLC650 VPC-MAX S-2

ASME B30.5



661,300 lb

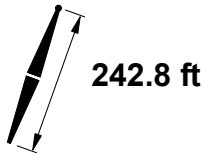

242.8 ft

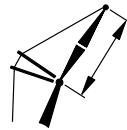

252.6 ft

ft	85°				83°				80°				ft
	ft	lb	lb	lb	ft	lb	lb	lb	ft	lb	lb	lb	
100	74.8	495.0	159,400	159,400									100
105	73.6	493.4	159,300	159,300									105
110	72.4	491.8	159,000	159,000									110
115	71.2	490.1	158,600	158,600									115
120	70.0	488.2	158,100	158,100	72.0	490.3	158,300	158,300					120
125	68.8	486.2	157,400	157,400	70.8	488.5	158,300	158,300					125
130	67.5	484.1	156,700	156,700	69.6	486.6	158,300	158,300					130
135	66.3	481.9	155,900	155,900	68.4	484.6	158,100	158,100					135
140	65.0	479.5	155,100	155,100	67.2	482.4	157,700	157,700					140
145	63.8	477.0	154,100	154,100	65.9	480.2	157,400	157,400	69.0	483.6	154,700	154,700	145
150	62.5	474.4	153,100	153,100	64.7	477.8	156,900	156,900	67.8	481.5	154,700	154,700	150
155	61.2	471.6	151,300	151,300	63.4	475.2	156,400	156,400	66.6	479.3	149,600	154,700	155
160	59.9	468.6	147,200	147,200	62.1	472.5	155,800	155,800	65.3	477.0	142,600	154,700	160
165	58.6	465.5	143,100	143,100	60.8	469.7	151,800	155,200	64.0	474.5	136,000	154,700	165
170	57.2	462.3	139,000	139,000	59.5	466.7	145,200	154,500	62.8	471.9	129,800	154,700	170
175	55.8	458.8	135,000	135,000	58.1	463.5	138,900	153,700	61.5	469.1	124,000	154,700	175
180	54.4	455.2	130,900	130,900	56.8	460.2	132,900	150,900	60.2	466.2	118,500	154,700	180
185	53.0	451.4	126,900	126,900	55.4	456.7	127,300	146,900	58.8	463.1	113,300	154,700	185
190	51.5	447.4	123,000	123,000	54.0	453.1	122,000	142,900	57.5	459.9	108,300	154,700	190
195	50.1	443.2	119,200	119,200	52.5	449.2	117,000	138,800	56.1	456.5	103,700	154,700	195
200	48.5	438.7	115,500	115,500	51.1	445.1	112,200	134,800	54.7	452.9	99,200	154,700	200
205	47.0	434.0	111,900	111,900	49.6	440.8	107,600	130,900	53.3	449.2	95,000	154,700	205
210	45.4	429.1	108,400	108,400	48.1	436.3	103,300	127,000	51.8	445.2	91,000	154,300	210
215	43.7	423.8	105,000	105,000	46.5	431.5	99,200	123,200	50.4	441.0	87,200	152,100	215
220	42.0	418.2	101,900	101,900	44.9	426.4	95,200	119,500	48.8	436.6	83,500	148,200	220
230	38.5	406.0	95,300	96,000	41.5	415.4	87,800	112,400	45.7	427.0	76,700	140,300	230
240	34.5	391.9	88,100	90,700	37.9	402.9	81,000	105,900	42.4	416.3	70,400	132,700	240
250	30.2	375.5	81,500	86,400	33.9	388.6	74,700	100,200	38.8	404.2	64,500	125,200	250
260	25.1	355.6	75,300	83,000	29.5	371.7	68,800	95,200	35.0	390.4	59,100	118,300	260
270	18.8	329.5	69,400	81,200	24.2	351.0	63,300	91,300	30.7	374.3	54,100	112,100	270
280	8.3	284.6	63,600	81,200	17.6	323.4	58,100	89,000	25.7	354.8	49,300	106,800	280
290					4.6	267.2	52,600	80,600	19.5	329.5	44,800	102,800	290
300									10.0	288.6	40,300	93,600	300
310													310
320													320
330													330
340													340
350													350
360													360

# MLC650 VPC-MAX S-2

ASME B30.5

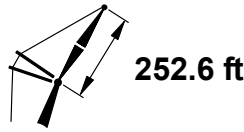
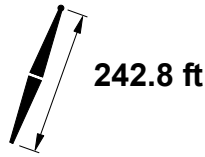

ft	75°				70°				65°				
	ft	lb	ft	lb	ft	lb	ft	lb	ft	lb	ft	lb	
100													100
105													105
110													110
115													115
120													120
125													125
130													130
135													135
140													140
145													145
150													150
155													155
160													160
165													165
170													170
175													175
180													180
185	64.2	470.0	90,200	145,400									185
190	62.9	467.4	85,900	145,400									190
195	61.6	464.6	81,800	145,400									195
200	60.3	461.7	78,000	145,400									200
205	59.0	458.7	74,300	145,400									205
210	57.7	455.5	70,800	145,400									210
215	56.3	452.1	67,500	145,400									215
220	54.9	448.5	64,300	144,900									220
230	52.0	440.9	58,300	136,100	57.7	448.9	40,400	122,800					230
240	49.1	432.3	52,800	128,100	54.9	442.0	35,700	115,300					240
250	45.9	422.8	47,800	120,700	52.1	434.3	31,400	108,400					250
260	42.6	412.2	43,100	113,800	49.1	425.8	27,400	102,100	54.8	433.3	90,700		260
270	39.1	400.2	38,700	107,500	46.0	416.3	23,600	96,200	51.9	425.6	85,300		270
280	35.2	386.5	34,700	101,600	42.7	405.7	20,200	90,800	49.0	417.0	80,200		280
290	31.0	370.6	30,800	96,100	39.1	393.8		85,700	45.8	407.5	75,500		290
300	26.0	351.4	27,200	90,900	35.3	380.1		80,900	42.5	396.8	71,200		300
310	20.0	326.6	23,700	86,000	31.0	364.2		76,400	39.0	384.8	67,000		310
320	10.9	287.7	20,100	81,300	26.1	345.1		72,200	35.1	371.0	63,200		320
330					20.1	320.4		68,200	30.8	355.0	59,500		330
340					11.1	282.0		64,300	25.9	335.6	56,000		340
350									19.8	310.6	52,700		350
360									10.4	270.8	49,400		360

# MLC650 VPC-MAX S-2

ASME B30.5



661,300 lb

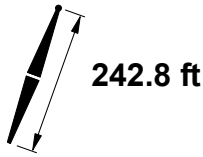

242.8 ft

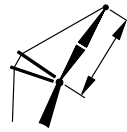

272.3 ft

ft	85°				83°				80°				ft
	ft	lb	lb	lb	ft	lb	lb	lb	ft	lb	lb	lb	
105	74.8	514.0	140,000	140,000									105
110	73.7	512.5	139,800	139,800									110
115	72.6	510.9	139,500	139,500									115
120	71.5	509.2	138,800	138,800									120
125	70.4	507.4	138,300	138,300	72.3	509.4	138,500	138,500					125
130	69.3	505.4	138,000	138,000	71.2	507.6	138,500	138,500					130
135	68.1	503.4	137,400	137,400	70.0	505.8	138,400	138,400					135
140	67.0	501.2	136,500	136,500	68.9	503.8	138,300	138,300					140
145	65.8	498.9	135,800	135,800	67.8	501.7	138,000	138,000					145
150	64.7	496.5	135,000	135,000	66.6	499.5	137,700	137,700	69.5	502.8	135,200	135,200	150
155	63.5	494.0	134,200	134,200	65.5	497.2	137,300	137,300	68.4	500.8	135,200	135,200	155
160	62.3	491.3	133,400	133,400	64.3	494.8	136,800	136,800	67.2	498.6	135,200	135,200	160
165	61.1	488.5	132,500	132,500	63.1	492.2	136,300	136,300	66.1	496.4	133,300	135,200	165
170	59.9	485.6	129,100	129,100	61.9	489.5	135,800	135,800	64.9	494.0	127,200	135,200	170
175	58.6	482.5	125,700	125,700	60.7	486.6	135,200	135,200	63.7	491.5	121,400	135,200	175
180	57.4	479.3	122,300	122,300	59.5	483.6	130,700	134,600	62.5	488.8	115,900	135,200	180
185	56.1	475.9	119,000	119,000	58.2	480.5	125,100	134,000	61.3	486.1	110,800	135,200	185
190	54.8	472.3	115,600	115,600	57.0	477.2	119,800	133,100	60.1	483.2	105,900	135,200	190
195	53.5	468.6	112,300	112,300	55.7	473.8	114,800	129,800	58.9	480.1	101,200	135,200	195
200	52.2	464.6	109,100	109,100	54.4	470.2	110,000	126,400	57.6	476.9	96,800	135,200	200
205	50.8	460.5	105,900	105,900	53.1	466.4	105,500	123,100	56.4	473.5	92,600	135,200	205
210	49.4	456.2	102,700	102,700	51.7	462.4	101,200	119,800	55.1	470.0	88,700	135,100	210
215	48.0	451.7	99,700	99,700	50.4	458.2	97,100	116,500	53.8	466.3	84,800	134,800	215
220	46.5	446.9	96,800	96,800	49.0	453.8	93,200	113,300	52.4	462.4	81,200	134,500	220
230	43.5	436.6	91,100	91,100	46.1	444.3	85,800	106,900	49.7	454.0	74,400	132,100	230
240	40.3	425.0	86,000	86,000	43.0	433.8	79,100	100,900	46.8	444.8	68,200	125,600	240
250	36.8	412.1	79,900	81,400	39.8	422.1	72,900	95,300	43.8	434.6	62,400	119,200	250
260	33.1	397.3	73,800	77,300	36.3	408.9	67,100	90,200	40.6	423.2	57,100	112,900	260
270	28.9	380.0	68,100	73,800	32.5	393.7	61,700	85,600	37.2	410.4	52,200	107,000	270
280	24.0	359.0	62,800	71,300	28.2	376.0	56,700	81,800	33.5	395.8	47,600	101,500	280
290	17.8	331.5	57,700	70,000	23.1	354.2	52,000	78,700	29.3	378.8	43,200	96,500	290
300	7.4	283.1	52,700	70,000	16.7	325.1	47,400	77,100	24.5	358.3	39,100	92,300	300
310					3.0	261.2	42,500	66,100	18.5	331.7	35,100	89,300	310
320									9.1	287.9	31,100	79,000	320
330													330
340													340
350													350
360													360
370													370
380													380

# MLC650 VPC-MAX S-2

ASME B30.5

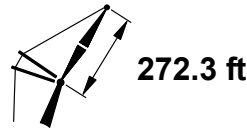
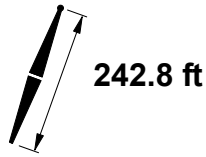
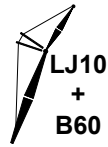

ft	75°				70°			65°			ft
	°	ft	lb	lb	°	ft	lb	°	ft	lb	
105											105
110											110
115											115
120											120
125											125
130											130
135											135
140											140
145											145
150											150
155											155
160											160
165											165
170											170
175											175
180											180
185											185
190											190
195	63.9	487.0	79,000	127,400							195
200	62.7	484.3	75,100	127,400							200
205	61.5	481.6	71,500	127,400							205
210	60.3	478.7	68,000	127,400							210
215	59.0	475.6	64,700	127,400							215
220	57.8	472.5	61,600	127,400							220
230	55.2	465.6	55,700	127,400							230
240	52.6	458.1	50,300	126,000	57.8	465.9	113,000				240
250	49.9	449.8	45,300	118,600	55.3	459.1	106,200				250
260	47.0	440.6	40,700	111,800	52.6	451.5	99,900				260
270	44.0	430.5	36,400	105,600	49.9	443.3	94,100				270
280	40.8	419.1	32,400	99,700	47.1	434.1	88,700	52.5	442.8	77,900	280
290	37.4	406.4	28,700	94,300	44.1	424.0	83,600	49.8	434.4	73,300	290
300	33.7	392.0	25,200	89,200	40.9	412.7	78,900	46.9	425.2	69,000	300
310	29.6	375.2	21,800	84,400	37.5	400.0	74,500	43.9	415.1	64,900	310
320	24.9	354.9		79,900	33.8	385.6	70,400	40.7	403.7	61,100	320
330	19.0	328.9		75,700	29.7	368.8	66,500	37.3	391.0	57,500	330
340	10.0	287.5		71,500	25.0	348.6	62,800	33.6	376.4	54,100	340
350					19.1	322.7	59,200	29.5	359.5	50,900	350
360					10.2	281.8	55,700	24.7	339.1	47,800	360
370								18.8	312.8	44,800	370
380								9.6	270.3	41,900	380

# MLC650 VPC-MAX S-2

ASME B30.5



661,300 lb

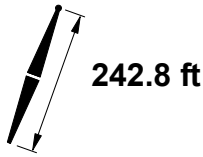

242.8 ft



292.0 ft

ft	85°				83°				80°				ft	
	ft	lb	lb	lb	ft	lb	lb	lb	ft	lb	lb	lb		
110	74.9	533.0	121,300	121,300									110	
115	73.8	531.6	120,800	120,800									115	
120	72.8	530.0	120,700	120,700									120	
125	71.8	528.3	120,100	120,100									125	
130	70.7	526.5	119,700	119,700	72.5	528.5	119,600	119,600					130	
135	69.7	524.6	119,200	119,200	71.4	526.7	119,600	119,600					135	
140	68.6	522.6	118,700	118,700	70.4	524.9	119,400	119,400					140	
145	67.6	520.5	118,100	118,100	69.3	523.0	119,200	119,200					145	
150	66.5	518.3	117,500	117,500	68.3	521.0	119,000	119,000					150	
155	65.4	516.0	116,800	116,800	67.2	518.8	118,600	118,600	69.9	522.0	116,100	116,100	155	
160	64.3	513.6	116,100	116,100	66.1	516.6	118,300	118,300	68.8	520.0	116,100	116,100	160	
165	63.2	511.0	115,400	115,400	65.1	514.2	117,900	117,900	67.8	517.9	116,100	116,100	165	
170	62.1	508.3	114,700	114,700	64.0	511.8	117,400	117,400	66.7	515.7	116,100	116,100	170	
175	61.0	505.5	113,900	113,900	62.9	509.2	116,900	116,900	65.6	513.4	116,100	116,100	175	
180	59.8	502.6	112,800	112,800	61.7	506.4	116,400	116,400	64.5	511.0	111,800	116,100	180	
185	58.7	499.5	110,000	110,000	60.6	503.6	115,900	115,900	63.4	508.5	106,700	116,100	185	
190	57.5	496.3	107,300	107,300	59.5	500.6	115,300	115,300	62.3	505.8	101,800	116,100	190	
195	56.3	492.9	104,500	104,500	58.3	497.5	111,000	114,800	61.2	503.0	97,200	116,100	195	
200	55.1	489.4	101,800	101,800	57.1	494.2	106,200	114,200	60.1	500.1	92,800	116,100	200	
205	53.9	485.7	99,000	99,000	56.0	490.8	101,700	113,600	58.9	497.1	88,600	115,900	205	
210	52.7	481.8	96,300	96,300	54.7	487.2	97,400	111,400	57.7	493.9	84,600	115,600	210	
215	51.4	477.8	93,700	93,700	53.5	483.5	93,300	108,700	56.6	490.5	80,900	115,300	215	
220	50.1	473.6	91,100	91,100	52.3	479.6	89,400	106,000	55.4	487.0	77,300	115,000	220	
230	47.5	464.6	86,000	86,000	49.7	471.2	82,100	100,600	52.9	479.6	70,500	114,400	230	
240	44.7	454.7	81,300	81,300	47.1	462.1	75,400	95,400	50.4	471.4	64,300	113,700	240	
250	41.8	443.7	76,400	76,800	44.3	452.0	69,200	90,300	47.8	462.5	58,600	111,900	250	
260	38.7	431.5	70,400	72,700	41.3	440.9	63,500	85,500	45.0	452.7	53,300	106,600	260	
270	35.4	417.9	64,800	69,000	38.2	428.5	58,200	81,000	42.1	441.8	48,400	101,400	270	
280	31.8	402.3	59,600	65,800	34.9	414.6	53,300	76,900	39.0	429.8	43,900	96,500	280	
290	27.7	384.1	54,700	63,100	31.2	398.6	48,600	73,300	35.7	416.3	39,600	91,700	290	
300	23.0	362.2	50,000	61,100	27.0	380.0	44,300	70,200	32.1	400.9	35,600	87,300	300	
310	17.0	333.2	45,600	60,200	22.1	357.2	40,100	67,800	28.1	383.1	31,800	83,300	310	
320	6.5	281.2	41,100	56,300	15.8	326.6	36,100	66,700	23.5	361.6	28,200	79,900	320	
330										17.7	333.6	24,700	77,600	330
340										8.3	287.0	21,100	64,500	340
350														350
360														360
370														370
380														380
390														390
400														400

# MLC650 VPC-MAX S-2

ASME B30.5

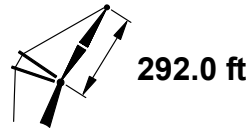
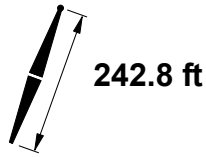

ft	75°				70°				65°				ft
	ft	lb	ft	lb	ft	lb	ft	lb	ft	lb	ft	lb	
110													110
115													115
120													120
125													125
130													130
135													135
140													140
145													145
150													150
155													155
160													160
165													165
170													170
175													175
180													180
185													185
190													190
195													195
200	64.7	506.5	70,700	108,100									200
205	63.6	503.9	67,100	108,100									205
210	62.5	501.3	63,700	108,100									210
215	61.3	498.5	60,400	108,100									215
220	60.2	495.6	57,300	108,100									220
230	57.9	489.4	51,400	108,100									230
240	55.5	482.7	46,100	108,100									240
250	53.1	475.2	41,100	108,100	57.9	482.9	99,800						250
260	50.6	467.1	36,600	108,100	55.6	476.1	96,400						260
270	47.9	458.2	32,300	102,400	53.1	468.7	90,700						270
280	45.2	448.5	28,400	96,600	50.6	460.6	85,300						280
290	42.3	437.7	24,700	91,200	48.0	451.7	80,300	53.0	459.9	69,800			290
300	39.3	425.7	21,300	86,100	45.2	442.0	75,700	50.5	451.8	65,500			300
310	36.0	412.4		81,400	42.4	431.2	71,300	47.8	442.9	61,500			310
320	32.4	397.1		77,000	39.3	419.3	67,200	45.1	433.1	57,700			320
330	28.4	379.5		72,800	36.0	405.9	63,400	42.2	422.3	54,200			330
340	23.8	358.3		68,800	32.5	390.8	59,700	39.1	410.3	50,800			340
350	18.1	330.9		65,000	28.5	373.1	56,300	35.9	396.8	47,700			350
360	9.2	286.9		61,300	23.9	352.0	53,000	32.3	381.6	44,700			360
370					18.2	324.8	49,800	28.3	363.8	41,800			370
380					9.4	281.3	46,700	23.6	342.5	39,100			380
390								17.9	314.8	36,400			390
400								8.8	269.5	33,800			400

# MLC650 VPC-MAX S-2

ASME B30.5

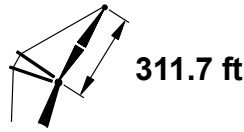
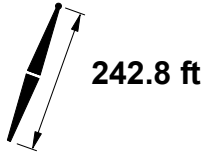

ft	85°				83°				80°				ft	
	ft	lb	lb	lb	ft	lb	lb	lb	ft	lb	lb	lb		
115	74.9	552.1	105,900	105,900									115	
120	73.9	550.6	105,600	105,600									120	
125	73.0	549.0	105,300	105,300									125	
130	72.0	547.4	104,800	104,800									130	
135	71.0	545.6	104,500	104,500	72.7	547.5	104,300	104,300					135	
140	70.0	543.8	103,800	103,800	71.7	545.8	104,200	104,200					140	
145	69.1	541.8	103,400	103,400	70.7	544.1	103,800	103,800					145	
150	68.1	539.8	102,900	102,900	69.7	542.2	103,600	103,600					150	
155	67.1	537.6	102,300	102,300	68.7	540.2	103,300	103,300					155	
160	66.0	535.4	101,700	101,700	67.7	538.1	103,100	103,100					160	
165	65.0	533.0	101,200	101,200	66.7	535.9	102,700	102,700	69.3	539.2	100,700	100,700	165	
170	64.0	530.6	100,500	100,500	65.7	533.7	102,400	102,400	68.3	537.2	100,700	100,700	170	
175	63.0	528.0	100,500	100,500	64.7	531.3	102,000	102,000	67.3	535.0	100,700	100,700	175	
180	61.9	525.3	99,300	99,300	63.7	528.8	101,500	101,500	66.3	532.8	100,700	100,700	180	
185	60.9	522.5	98,600	98,600	62.6	526.1	101,100	101,100	65.2	530.5	100,700	100,700	185	
190	59.8	519.5	97,900	97,900	61.6	523.4	100,600	100,600	64.2	528.0	99,300	100,700	190	
195	58.7	516.4	96,500	96,500	60.5	520.5	100,100	100,100	63.2	525.5	94,700	100,600	195	
200	57.6	513.2	94,200	94,200	59.5	517.6	99,600	99,600	62.1	522.8	90,300	100,400	200	
205	56.5	509.9	92,000	92,000	58.4	514.5	99,100	99,100	61.1	520.0	86,200	100,300	205	
210	55.4	506.4	89,700	89,700	57.3	511.2	95,300	98,600	60.0	517.1	82,300	100,100	210	
215	54.3	502.8	87,400	87,400	56.2	507.8	91,200	98,100	58.9	514.0	78,500	99,800	215	
220	53.1	499.0	85,100	85,100	55.1	504.3	87,300	97,500	57.9	510.8	74,900	99,600	220	
230	50.8	490.9	80,700	80,700	52.8	496.8	80,000	93,700	55.6	504.1	68,200	99,000	230	
240	48.3	482.2	76,400	76,400	50.4	488.6	73,300	89,300	53.4	496.7	62,000	98,400	240	
250	45.8	472.6	72,300	72,300	47.9	479.7	67,200	84,900	51.0	488.7	56,400	97,800	250	
260	43.1	462.1	68,500	68,500	45.4	470.0	61,500	80,600	48.6	480.0	51,100	97,100	260	
270	40.3	450.5	63,000	64,800	42.7	459.4	56,300	76,500	46.0	470.5	46,300	95,100	270	
280	37.3	437.7	57,800	61,600	39.8	447.6	51,400	72,500	43.4	460.1	41,800	90,800	280	
290	34.1	423.4	53,000	58,600	36.8	434.6	46,800	68,900	40.6	448.7	37,600	86,600	290	
300	30.6	407.1	48,500	56,000	33.6	420.0	42,500	65,700	37.6	436.0	33,600	82,400	300	
310	26.6	388.1	44,200	53,900	30.0	403.3	38,500	62,700	34.4	421.9	29,900	78,600	310	
320	22.0	365.1	40,100	52,400	26.0	383.8	34,600	60,300	31.0	405.8	26,400	75,000	320	
330	16.2	334.8	36,200	51,900	21.2	360.0	31,000	58,500	27.1	387.1	23,000	71,900	330	
340	5.7	278.6	32,100	45,500	15.0	327.9	27,400	57,700	22.5	364.6		69,200	340	
350										16.8	335.4		67,400	350
360										7.5	285.6		53,300	360
370														370
380														380
390														390
400														400
410														410
420														420



# MLC650 VPC-MAX S-2

ASME B30.5

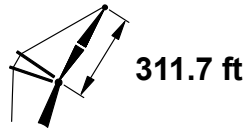
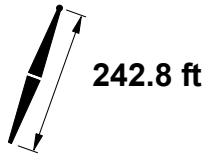

ft	75°				70°				65°				
	ft	ft	lb	lb	ft	ft	lb	lb	ft	ft	lb	lb	
115													115
120													120
125													125
130													130
135													135
140													140
145													145
150													150
155													155
160													160
165													165
170													170
175													175
180													180
185													185
190													190
195													195
200													200
205													205
210	64.4	523.5	60,900	93,200									210
215	63.3	520.9	57,700	93,200									215
220	62.3	518.3	54,600	93,200									220
230	60.2	512.6	48,800	93,200									230
240	58.0	506.4	43,500	93,200									240
250	55.8	499.7	38,600	93,200									250
260	53.5	492.4	34,100	93,200	58.0	499.9	85,400						260
270	51.2	484.4	29,900	93,200	55.8	493.1	85,400						270
280	48.7	475.8	26,000	93,200	53.5	485.8	83,200						280
290	46.2	466.3	22,300	89,200	51.2	477.9	78,200						290
300	43.6	456.0		84,200	48.8	469.3	73,600	53.4	477.1	63,300			300
310	40.8	444.6		79,600	46.2	459.8	69,300	51.1	469.1	59,300			310
320	37.8	432.1		75,200	43.6	449.5	65,200	48.7	460.4	55,600			320
330	34.7	418.0		71,000	40.8	438.2	61,400	46.1	451.0	52,100			330
340	31.2	402.1		67,100	37.9	425.6	57,800	43.5	440.6	48,800			340
350	27.3	383.6		63,400	34.7	411.6	54,400	40.7	429.2	45,700			350
360	22.9	361.4		59,900	31.3	395.7	51,200	37.7	416.6	42,700			360
370	17.3	332.8		56,600	27.4	377.3	48,100	34.5	402.5	39,900			370
380	8.5	286.0		53,200	22.9	355.2	45,200	31.1	386.5	37,200			380
390					17.4	326.7	42,400	27.2	367.9	34,700			390
400					8.7	280.6	39,600	22.7	345.6	32,200			400
410								17.1	316.6	29,800			410
420								8.0	268.4	27,400			420

# MLC650 VPC-MAX S-2

ASME B30.5



661,300 lb

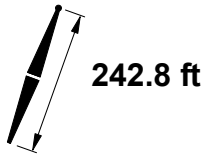

242.8 ft

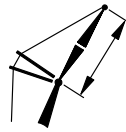

331.4 ft

ft	85°				83°				80°				ft
	ft	lb	lb	lb	ft	lb	lb	lb	ft	lb	lb	lb	
120	74.9	571.1	89,000	89,000									120
125	74.0	569.7	88,700	88,700									125
130	73.1	568.1	88,400	88,400									130
135	72.2	566.5	88,100	88,100									135
140	71.3	564.7	87,700	87,700	72.8	566.6	87,400	87,400					140
145	70.4	562.9	87,300	87,300	71.9	564.9	87,300	87,300					145
150	69.4	561.0	86,900	86,900	71.0	563.2	87,100	87,100					150
155	68.5	559.0	86,500	86,500	70.1	561.3	86,800	86,800					155
160	67.6	556.9	86,000	86,000	69.1	559.4	86,600	86,600					160
165	66.6	554.7	85,600	85,600	68.2	557.4	86,200	86,200					165
170	65.7	552.4	85,000	85,000	67.3	555.3	85,900	85,900	69.6	558.4	84,100	84,100	170
175	64.7	550.0	84,500	84,500	66.3	553.0	85,600	85,600	68.7	556.4	84,100	84,100	175
180	63.7	547.6	84,100	84,100	65.4	550.7	85,300	85,300	67.8	554.3	84,000	84,000	180
185	62.8	544.9	83,500	83,500	64.4	548.3	84,900	84,900	66.8	552.1	84,000	84,000	185
190	61.8	542.2	83,000	83,000	63.4	545.7	84,500	84,500	65.9	549.9	83,900	83,900	190
195	60.8	539.4	82,500	82,500	62.5	543.1	84,100	84,100	64.9	547.5	83,700	83,700	195
200	59.8	536.5	82,000	82,000	61.5	540.4	83,700	83,700	63.9	545.0	83,600	83,600	200
205	58.8	533.4	81,400	81,400	60.5	537.5	83,300	83,300	63.0	542.4	82,300	83,400	205
210	57.7	530.2	80,800	80,800	59.5	534.5	82,900	82,900	62.0	539.7	78,300	83,200	210
215	56.7	526.9	80,200	80,200	58.5	531.4	82,500	82,500	61.0	536.9	74,600	83,000	215
220	55.7	523.5	78,400	78,400	57.4	528.2	82,000	82,000	60.0	534.0	71,000	82,800	220
230	53.5	516.1	74,700	74,700	55.3	521.3	76,400	81,200	58.0	527.8	64,300	82,400	230
240	51.3	508.2	71,100	71,100	53.2	513.9	69,700	80,300	55.9	521.1	58,200	81,900	240
250	49.0	499.7	67,600	67,600	51.0	505.9	63,600	78,600	53.7	513.9	52,600	81,300	250
260	46.7	490.4	64,100	64,100	48.7	497.3	58,000	75,100	51.5	506.0	47,400	80,800	260
270	44.2	480.2	59,600	60,900	46.3	487.8	52,700	71,600	49.3	497.5	42,600	80,200	270
280	41.6	469.2	54,400	57,700	43.8	477.6	47,900	68,100	46.9	488.3	38,100	79,700	280
290	38.9	457.1	49,700	54,800	41.2	466.4	43,300	64,800	44.5	478.3	33,900	79,200	290
300	36.0	443.7	45,200	52,200	38.5	454.1	39,100	61,700	41.9	467.3	30,000	77,200	300
310	32.9	428.7	41,000	49,800	35.6	440.4	35,100	58,800	39.2	455.3	26,300	73,900	310
320	29.5	411.6	37,000	47,700	32.4	425.1	31,300	56,200	36.3	442.0	22,800	69,500	320
330	25.7	391.9	33,200	46,000	28.9	407.8	27,800	53,800	33.2	427.2		64,600	330
340	21.2	367.9	29,600	44,900	25.0	387.4	24,400	51,300	29.9	410.4		59,500	340
350	15.4	336.2	26,100	41,700	20.4	362.6	21,100	46,700	26.1	391.0		54,600	350
360	4.7	275.3	22,400	34,300	14.3	329.0		42,300	21.7	367.5		49,600	360
370									16.1	337.0		45,000	370
380									6.8	283.8		41,100	380
390													390
400													400
410													410
420													420
430													430

# MLC650 VPC-MAX S-2

ASME B30.5

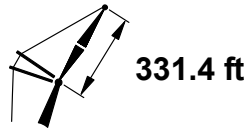
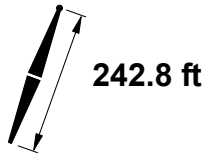

ft	75°				70°			65°			ft
	ft	lb	lb	lb	ft	lb	lb	ft	lb	lb	
120											120
125											125
130											130
135											135
140											140
145											145
150											150
155											155
160											160
165											165
170											170
175											175
180											180
185											185
190											190
195											195
200											200
205											205
210											210
215											215
220	64.1	540.5	50,300	77,400							220
230	62.1	535.2	44,600	77,400							230
240	60.1	529.5	39,300	77,400							240
250	58.1	523.4	34,500	77,400							250
260	56.0	516.7	30,000	77,400							260
270	53.9	509.5	25,800	77,400	58.1	516.8	70,500				270
280	51.7	501.7	22,000	77,400	56.0	510.2	70,500				280
290	49.4	493.2		77,400	53.9	503.0	70,500				290
300	47.1	484.1		77,400	51.7	495.2	70,400				300
310	44.6	474.1		76,600	49.5	486.7	66,100	53.8	494.2	55,900	310
320	42.1	463.2		72,200	47.1	477.6	62,100	51.6	486.4	52,300	320
330	39.4	451.3		68,100	44.7	467.6	58,300	49.3	477.9	48,800	330
340	36.5	438.1		64,200	42.1	456.7	54,700	47.0	468.7	45,500	340
350	33.5	423.4		60,600	39.4	444.8	51,400	44.6	458.7	42,400	350
360	30.1	406.7		57,100	36.6	431.7	48,200	42.0	447.8	39,500	360
370	26.3	387.5		53,800	33.5	417.0	45,200	39.3	435.8	36,700	370
380	22.0	364.4		50,700	30.2	400.4	42,300	36.4	422.6	34,100	380
390	16.5	334.5		47,500	26.4	381.2	39,500	33.3	407.8	31,600	390
400	7.8	284.8		43,400	22.1	358.2	36,900	30.0	391.1	29,200	400
410					16.6	328.4	34,400	26.2	371.8	26,900	410
420					8.0	279.5	31,800	21.8	348.5	24,500	420
430								16.3	318.3	21,900	430

# MLC650 VPC-MAX S-2

ASME B30.5



661,300 lb

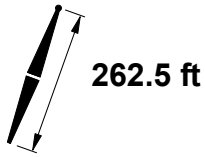

262.5 ft

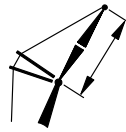

85.3 ft

ft	85°				83°				80°				ft
	ft	lb	lb	lb	ft	lb	lb	lb	ft	lb	lb	lb	
60	73.2	352.3	448,800 d	448,800 d									60
65	69.6	350.4	446,100 d	446,100 d									65
70	65.9	348.0	441,000 c	441,000 c	72.6	351.0	459,900 d	459,900 d					70
75	62.1	345.2	434,600 c	434,600 c	69.0	348.9	450,700 c	450,700 c					75
80	58.1	342.0	426,500 b	426,500 b	65.2	346.5	428,600 c	446,900 c					80
85	53.9	338.2	402,400 b	402,400 b	61.4	343.6	399,000 c	441,600 c					85
90	49.4	333.8	380,400	380,400	57.3	340.3	372,800 b	435,500 b	67.9	346.1	345,800 c	453,200 c	90
95	44.6	328.7	361,900	361,900	53.1	336.4	349,500 b	424,300 b	64.2	343.5	324,100 c	452,600 c	95
100	39.2	322.5	344,200	346,800	48.6	331.9	328,500	400,900	60.3	340.6	304,700 b	448,200 b	100
105	33.1	314.8	324,200	335,400	43.7	326.6	309,500	381,100	56.2	337.1	287,100 b	435,100 b	105
110	25.5	304.7	305,900	328,800	38.2	320.2	292,300	364,900	51.9	333.0	271,100 b	411,900 b	110
115	13.8	288.1	288,500	326,000	31.9	312.2	276,400	352,700	47.2	328.3	256,500	390,900	115
120					23.9	301.4	261,600	345,400	42.2	322.7	243,100	371,700	120
125					10.0	281.4	247,200	313,200	36.5	315.9	230,700	354,100	125
130									29.9	307.3	219,100	337,900	130
135									21.1	295.3	208,100	322,800	135
140													140
145													145
150													150
155													155
160													160
165													165
170													170
175													175
180													180
185													185
190													190
195													195
200													200

# MLC650 VPC-MAX S-2

ASME B30.5

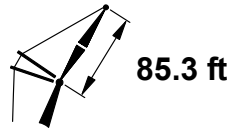
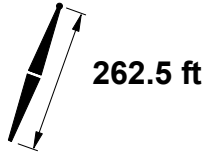
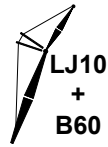

ft	75°				70°				65°				ft
	ft	°	ft	lb	ft	°	ft	lb	ft	°	ft	lb	
60													60
65													65
70													70
75													75
80													80
85													85
90													90
95													95
100													100
105													105
110													110
115													115
120	62.1	336.8	211,100 b	347,000 b									120
125	58.1	333.5	200,300 b	330,600 b									125
130	53.9	329.8	190,400 b	315,500 b									130
135	49.4	325.4	181,100 b	301,600 b									135
140	44.6	320.2	172,500	288,700									140
145	39.3	314.0	164,400	276,800	59.6	327.6	139,000 b	257,400 b					145
150	33.2	306.4	156,700	265,600	55.4	324.0	132,500 b	247,000 b					150
155	25.6	296.3	149,400	255,000	51.1	319.9	126,400 b	237,300 b					155
160	14.0	279.8	142,000	244,900	46.4	315.0	120,700	228,200					160
165					41.3	309.2	115,200	219,700					165
170					35.5	302.2	110,000	211,600					170
175					28.6	293.2	104,900	204,000	52.1	311.8	85,300	189,000	175
180					19.2	280.1	99,900	196,600	47.5	307.1	81,300	182,400	180
185									42.4	301.5	77,600	176,100	185
190									36.8	294.8	73,900	170,100	190
195									30.2	286.4	70,300	164,300	195
200									21.6	274.5	66,700	158,700	200

# MLC650 VPC-MAX S-2

ASME B30.5

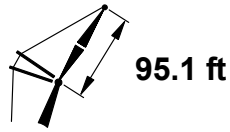
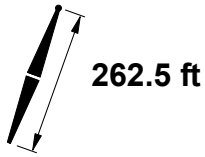

ft	85°				83°				80°				ft
	ft	lb	lb	lb	ft	lb	lb	lb	ft	lb	lb	lb	
65	71.8	361.0	417,200 c	417,200 c									65
70	68.6	358.9	413,600 c	413,600 c									70
75	65.2	356.5	408,500 c	408,500 c	71.3	359.6	421,000 c	421,000 c					75
80	61.8	353.7	402,600 b	402,600 b	68.0	357.4	419,000 c	419,000 c					80
85	58.2	350.5	395,100 b	395,100 b	64.6	355.0	396,200 b	415,000 b					85
90	54.5	346.8	373,600	373,600	61.2	352.1	370,200 b	410,000 b					90
95	50.5	342.6	354,000	354,000	57.6	348.8	346,900 b	404,400 b	67.1	354.6	321,000 b	421,600 b	95
100	46.3	337.7	337,300	337,300	53.8	345.1	326,100	396,000	63.7	352.0	301,600 b	420,200 b	100
105	41.8	332.1	322,600	323,100	49.8	340.7	307,300	375,000	60.2	349.0	284,200 b	417,100 b	105
110	36.8	325.3	304,600	311,900	45.6	335.7	290,200	356,900	56.5	345.6	268,300 b	409,200 b	110
115	30.9	317.1	288,100	303,700	41.0	329.9	274,600	341,700	52.7	341.7	253,900	388,300	115
120	23.7	306.2	272,800	299,600	35.8	322.9	260,200	329,400	48.7	337.2	240,600	369,200	120
125	12.4	288.0	258,200	295,400	29.8	314.3	246,900	320,500	44.3	332.0	228,400	351,800	125
130					22.2	302.7	234,400	315,900	39.6	325.9	217,100	335,700	130
135					8.4	280.4	222,000	283,100	34.2	318.5	206,500	320,900	135
140									27.9	309.3	196,600	307,100	140
145									19.5	296.3	187,100	294,300	145
150													150
155													155
160													160
165													165
170													170
175													175
180													180
185													185
190													190
195													195
200													200
205													205
210													210

# MLC650 VPC-MAX S-2

ASME B30.5

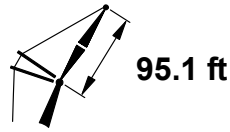
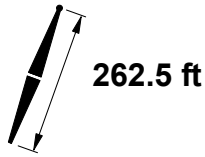
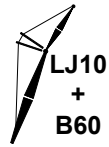

ft	75°				70°				65°				ft
	ft	ft	lb	lb	ft	ft	lb	lb	ft	ft	lb	lb	
65													65
70													70
75													75
80													80
85													85
90													90
95													95
100													100
105													105
110													110
115													115
120													120
125	61.8	345.2	197,000 b	327,800 b									125
130	58.3	342.0	187,200 b	312,800 b									130
135	54.5	338.4	178,100 b	299,000 b									135
140	50.6	334.1	169,600	286,200									140
145	46.4	329.3	161,700	274,300									145
150	41.9	323.6	154,200	263,300	59.6	336.1	129,100	244,200					150
155	36.8	316.9	147,200	252,900	55.9	332.6	123,100	234,600					155
160	31.0	308.7	140,500	243,200	52.0	328.6	117,500	225,600					160
165	23.8	297.8	134,000	234,000	47.9	324.0	112,200	217,200					165
170	12.6	279.8	127,500	225,100	43.5	318.6	107,100	209,200					170
175					38.7	312.3	102,300	201,700					175
180					33.2	304.7	97,700	194,600	52.9	320.5	77,900	179,600	180
185					26.6	295.0	93,200	187,800	48.9	316.0	74,300	173,500	185
190					17.6	280.8	88,600	181,300	44.5	310.8	70,800	167,600	190
195									39.8	304.7	67,500	162,000	195
200									34.5	297.5	64,200	156,600	200
205									28.2	288.3	61,000	151,500	205
210									20.0	275.6	57,700	146,500	210

# MLC650 VPC-MAX S-2

ASME B30.5

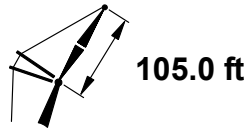
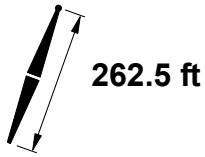

ft	85°				83°				80°				ft
	ft	lb	lb	lb	ft	lb	lb	lb	ft	lb	lb	lb	
65	73.6	371.4	390,300 c	390,300 c									65
70	70.7	369.6	388,300 c	388,300 c									70
75	67.7	367.4	384,500 c	384,500 c									75
80	64.7	365.0	379,700 b	379,700 b	70.2	368.2	392,500 c	392,500 c					80
85	61.6	362.2	373,500 b	373,500 b	67.2	366.0	390,000 b	390,000 b					85
90	58.3	359.0	368,400	368,400	64.2	363.4	368,700 b	386,300 b					90
95	55.0	355.4	348,800	348,800	61.0	360.6	345,600 b	381,800 b	69.4	365.4	319,200 b	393,000 b	95
100	51.5	351.3	331,300	331,300	57.8	357.3	324,800	376,900	66.4	363.1	299,900 b	393,000 b	100
105	47.7	346.7	316,100	316,100	54.4	353.6	306,100	370,900	63.3	360.5	282,600 b	392,300 b	105
110	43.8	341.4	303,000	303,000	50.8	349.5	289,200	352,500	60.1	357.5	266,800 b	389,200 b	110
115	39.5	335.2	287,800	292,100	47.1	344.7	273,700	335,900	56.8	354.1	252,400	385,700	115
120	34.7	328.0	272,800	283,500	43.0	339.3	259,500	321,700	53.4	350.3	239,300	367,700	120
125	29.1	319.2	259,000	277,600	38.6	333.0	246,400	309,900	49.8	346.0	227,200	350,400	125
130	22.2	307.5	246,000	275,400	33.7	325.5	234,200	300,400	46.0	341.1	216,000	334,400	130
135	11.1	287.8	233,500	269,700	28.0	316.3	222,900	293,900	41.8	335.4	205,600	319,700	135
140					20.7	303.9	212,200	291,300	37.3	328.8	196,000	306,100	140
145					6.8	279.0	201,400	257,200	32.2	320.9	186,900	293,400	145
150									26.2	311.0	178,300	281,600	150
155									18.1	297.1	170,000	270,400	155
160													160
165													165
170													170
175													175
180													180
185													185
190													190
195													195
200													200
205													205
210													210
215													215
220													220



# MLC650 VPC-MAX S-2

ASME B30.5

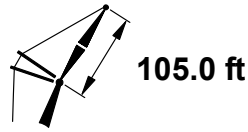
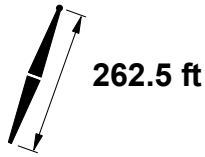
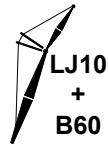

ft	75°				70°				65°				ft
	ft	°	ft	lb	ft	°	ft	lb	ft	°	ft	lb	
65													65
70													70
75													75
80													80
85													85
90													90
95													95
100													100
105													105
110													110
115													115
120													120
125	64.7	356.5	195,100 b	326,000 b									125
130	61.6	353.7	185,400	311,100									130
135	58.4	350.5	176,400	297,400									135
140	55.0	346.9	168,000	284,700									140
145	51.5	342.9	160,100	272,900									145
150	47.8	338.2	152,800	261,900									150
155	43.8	332.9	145,900	251,700	59.6	344.5	121,200	232,900					155
160	39.5	326.8	139,400	242,100	56.2	341.1	115,700	224,000					160
165	34.7	319.6	133,300	233,000	52.8	337.2	110,400	215,700					165
170	29.2	310.8	127,400	224,500	49.1	332.8	105,500	207,800					170
175	22.3	299.2	121,700	216,400	45.3	327.8	100,800	200,400					175
180	11.3	279.6	115,800	208,600	41.1	322.0	96,400	193,400					180
185					36.5	315.2	92,100	186,700	53.6	329.1	72,400	171,900	185
190					31.3	307.0	87,900	180,400	50.0	324.8	69,000	166,100	190
195					25.0	296.6	83,900	174,400	46.1	319.9	65,800	160,600	195
200					16.3	281.4	79,800	168,500	42.0	314.3	62,700	155,300	200
205									37.6	307.7	59,700	150,300	205
210									32.5	299.9	56,700	145,500	210
215									26.5	290.1	53,800	140,900	215
220									18.6	276.5	50,900	136,300	220

# MLC650 VPC-MAX S-2

ASME B30.5



661,300 lb

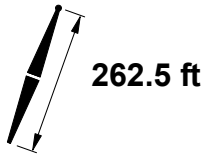

262.5 ft

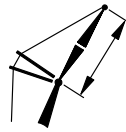

114.8 ft

ft	85°				83°				80°				ft
	ft	lb	lb	lb	ft	lb	lb	lb	ft	lb	lb	lb	
70	72.4	380.1	362,400 c	362,400 c									70
75	69.8	378.2	360,000 b	360,000 b									75
80	67.0	376.0	356,400 b	356,400 b	72.0	378.7	365,300 b	365,300 b					80
85	64.2	373.5	352,100 b	352,100 b	69.3	376.7	364,400 b	364,400 b					85
90	61.4	370.6	347,200	347,200	66.6	374.5	362,100 b	362,100 b					90
95	58.4	367.5	341,100	341,100	63.8	371.9	342,800 b	358,700 b					95
100	55.4	363.9	327,300	327,300	60.9	369.0	322,100	354,800	68.5	373.9	296,800 b	365,500 b	100
105	52.2	360.0	311,400	311,400	57.9	365.8	303,500	350,400	65.8	371.6	279,500 b	365,500 b	105
110	48.9	355.5	297,500	297,500	54.8	362.2	286,600	345,200	63.0	368.9	263,800	364,500	110
115	45.3	350.5	285,300	285,300	51.6	358.2	271,200	332,700	60.1	366.0	249,500	362,000	115
120	41.5	344.8	270,900	275,000	48.3	353.6	257,100	317,500	57.1	362.6	236,400	359,100	120
125	37.4	338.2	257,200	266,400	44.7	348.5	244,100	304,200	53.9	358.9	224,400	347,800	125
130	32.8	330.5	244,600	259,800	40.8	342.6	232,100	292,900	50.7	354.7	213,300	332,000	130
135	27.5	321.1	232,800	254,300	36.7	335.9	221,000	283,500	47.3	350.0	203,100	317,400	135
140	20.9	308.7	221,700	250,700	32.0	327.9	210,600	276,100	43.6	344.7	193,500	303,800	140
145	9.9	287.3	210,800	244,400	26.5	318.1	200,900	269,600	39.7	338.6	184,600	291,300	145
150					19.4	304.9	191,500	265,600	35.4	331.6	176,200	279,600	150
155					5.1	276.7	181,900	230,600	30.5	323.2	168,300	268,600	155
160									24.7	312.7	160,800	258,300	160
165									16.9	297.8	153,500	248,600	165
170													170
175													175
180													180
185													185
190													190
195													195
200													200
205													205
210													210
215													215
220													220
230													230

# MLC650 VPC-MAX S-2

ASME B30.5

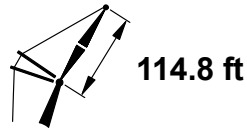
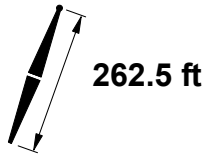

ft	75°				70°				65°				ft
	ft	°	ft	lb	ft	°	ft	lb	ft	°	ft	lb	
70													70
75													75
80													80
85													85
90													90
95													95
100													100
105													105
110													110
115													115
120													120
125													125
130	64.3	365.0	182,000	308,200									130
135	61.4	362.2	173,100	294,600									135
140	58.5	359.0	164,800	282,000									140
145	55.4	355.5	157,000	270,300									145
150	52.2	351.5	149,800	259,400									150
155	48.9	347.1	143,000	249,200									155
160	45.4	342.1	136,600	239,700	59.5	353.0	112,200	221,200					160
165	41.6	336.4	130,600	230,700	56.5	349.6	107,100	212,900					165
170	37.5	329.8	124,900	222,300	53.4	345.8	102,200	205,100					170
175	32.9	322.1	119,400	214,400	50.1	341.6	97,600	197,800					175
180	27.6	312.7	114,200	206,900	46.7	336.8	93,300	190,900					180
185	20.9	300.3	109,100	199,700	43.0	331.3	89,100	184,300					185
190	10.1	279.2	103,800	192,700	39.0	325.1	85,100	178,100	54.1	337.7	65,600	163,400	190
195					34.6	317.9	81,300	172,200	50.9	333.5	62,400	157,900	195
200					29.6	309.2	77,600	166,500	47.4	328.8	59,400	152,700	200
205					23.6	298.1	74,000	161,100	43.8	323.5	56,500	147,800	205
210					15.1	281.9	70,300	155,800	39.9	317.5	53,700	143,100	210
215									35.6	310.5	51,000	138,600	215
220									30.8	302.2	48,300	134,200	220
230									17.3	277.2	43,000	125,900	230

# MLC650 VPC-MAX S-2

ASME B30.5

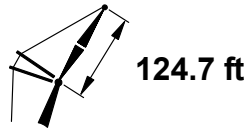
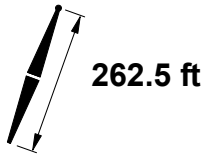

ft	85°				83°				80°				ft
	ft	lb	lb	lb	ft	lb	lb	lb	ft	lb	lb	lb	
70	73.9	390.5	340,700 c	340,700 c									70
75	71.4	388.7	339,400 b	339,400 b									75
80	69.0	386.7	336,800 b	336,800 b									80
85	66.4	384.5	333,400 b	333,400 b	71.0	387.3	342,600 b	342,600 b					85
90	63.9	381.9	329,500 b	329,500 b	68.5	385.3	341,400 b	341,400 b					90
95	61.2	379.1	325,200	325,200	66.0	383.0	339,200 b	339,200 b					95
100	58.5	376.0	319,500	319,500	63.4	380.4	322,300	336,100					100
105	55.7	372.5	308,400	308,400	60.8	377.5	303,800	332,600	67.8	382.5	279,500 b	342,900 b	105
110	52.8	368.6	294,100	294,100	58.0	374.3	286,900	328,900	65.3	380.1	263,900	342,800	110
115	49.8	364.3	281,400	281,400	55.2	370.8	271,600	325,000	62.7	377.4	249,600	341,800	115
120	46.6	359.5	270,200	270,200	52.3	366.8	257,500	314,000	60.0	374.4	236,600	339,800	120
125	43.2	354.1	258,000	260,500	49.2	362.4	244,600	301,300	57.3	371.1	224,700	337,300	125
130	39.6	348.0	245,500	251,000	46.0	357.5	232,700	289,200	54.4	367.5	213,600	331,800	130
135	35.7	341.0	233,900	242,200	42.6	352.0	221,700	277,800	51.4	363.4	203,400	317,200	135
140	31.3	332.8	223,000	234,900	38.9	345.8	211,500	267,300	48.3	358.9	193,900	303,700	140
145	26.1	322.9	212,900	229,500	34.9	338.6	201,900	257,900	45.1	353.8	185,100	291,200	145
150	19.7	309.8	203,200	227,000	30.4	330.2	192,900	250,000	41.6	348.1	176,800	279,600	150
155	8.8	286.6	193,700	225,200	25.1	319.8	184,400	244,100	37.8	341.7	169,100	268,700	155
160					18.3	305.8	176,200	241,200	33.7	334.2	161,700	258,600	160
165									29.0	325.3	154,800	249,000	165
170									23.4	314.2	148,200	240,000	170
175									15.8	298.4	141,700	231,400	175
180													180
185													185
190													190
195													195
200													200
205													205
210													210
215													215
220													220
230													230
240													240

# MLC650 VPC-MAX S-2

ASME B30.5

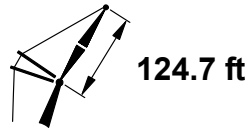
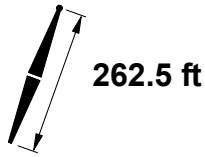

ft	75°				70°				65°				ft
	ft	°	ft	lb	ft	°	ft	lb	ft	°	ft	lb	
70													70
75													75
80													80
85													85
90													90
95													95
100													100
105													105
110													110
115													115
120													120
125													125
130													130
135	63.9	373.5	173,100	294,300									135
140	61.3	370.6	164,800	281,700									140
145	58.6	367.5	157,100	270,000									145
150	55.8	364.0	149,900	259,200									150
155	52.8	360.1	143,200	249,100									155
160	49.8	355.8	136,900	239,600									160
165	46.6	351.0	130,900	230,700	59.5	361.5	107,100	212,700					165
170	43.3	345.7	125,300	222,400	56.8	358.1	102,300	205,000					170
175	39.6	339.6	120,000	214,500	53.9	354.4	97,800	197,700					175
180	35.7	332.6	114,900	207,100	50.9	350.3	93,400	190,800					180
185	31.3	324.4	110,100	200,000	47.8	345.7	89,400	184,300					185
190	26.2	314.5	105,400	193,300	44.5	340.5	85,500	178,100					190
195	19.8	301.4	100,800	186,900	41.0	334.7	81,700	172,300	54.5	346.2	62,500	157,800	195
200	9.0	278.6	96,000	180,600	37.2	328.1	78,200	166,700	51.6	342.2	59,500	152,700	200
205					33.0	320.4	74,700	161,400	48.5	337.7	56,700	147,800	205
210					28.1	311.2	71,400	156,300	45.2	332.6	53,900	143,100	210
215					22.3	299.5	68,100	151,400	41.8	327.0	51,300	138,700	215
220					14.0	282.2	64,700	146,600	38.0	320.6	48,800	134,400	220
230									29.3	304.3	43,900	126,400	230
240									16.2	277.9	39,000	118,800	240

# MLC650 VPC-MAX S-2

ASME B30.5



661,300 lb



360°

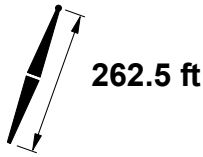

262.5 ft



134.5 ft

ft	85°				83°				80°				ft
	ft	lb	lb	lb	ft	lb	lb	lb	ft	lb	lb	lb	
75	72.9	399.2	318,300 b	318,300 b									75
80	70.6	397.4	316,700 b	316,700 b									80
85	68.3	395.3	314,200 b	314,200 b	72.5	397.8	320,400 b	320,400 b					85
90	65.9	393.0	311,000	311,000	70.2	395.9	320,100 b	320,100 b					90
95	63.6	390.4	307,400	307,400	67.9	393.8	318,800	318,800					95
100	61.1	387.6	303,500	303,500	65.5	391.5	316,700	316,700					100
105	58.6	384.5	298,200	298,200	63.1	388.9	301,000	314,000	69.5	393.2	276,400	319,600	105
110	56.0	381.0	286,200	286,200	60.7	386.0	284,200	310,900	67.2	391.0	260,800	319,600	110
115	53.3	377.2	274,400	274,400	58.1	382.8	269,000	307,000	64.9	388.6	246,600	319,600	115
120	50.6	373.0	263,100	263,100	55.5	379.3	255,000	303,500	62.4	385.9	233,700	319,500	120
125	47.7	368.4	252,400	252,400	52.9	375.4	242,100	291,800	60.0	382.9	221,800	317,800	125
130	44.6	363.3	242,300	242,300	50.1	371.2	230,300	280,300	57.4	379.6	210,800	315,700	130
135	41.4	357.5	231,800	233,000	47.1	366.5	219,400	269,300	54.8	376.0	200,600	313,200	135
140	37.9	351.1	221,100	224,600	44.1	361.2	209,200	258,900	52.1	372.1	191,200	301,400	140
145	34.1	343.7	211,100	217,300	40.8	355.4	199,700	249,100	49.2	367.7	182,500	288,900	145
150	29.8	335.1	201,800	211,300	37.2	348.8	190,800	240,200	46.3	362.8	174,300	277,300	150
155	24.9	324.6	192,900	207,000	33.4	341.2	182,500	232,200	43.2	357.4	166,600	266,500	155
160	18.6	310.7	184,400	205,300	29.0	332.3	174,600	225,700	39.8	351.4	159,400	256,400	160
165	7.7	285.7	175,900	205,300	23.9	321.4	167,100	220,800	36.2	344.5	152,600	247,000	165
170					17.3	306.6	159,900	218,800	32.2	336.6	146,100	238,000	170
175									27.7	327.3	140,000	229,600	175
180									22.3	315.5	134,100	221,600	180
185									14.8	298.8	128,300	214,000	185
190													190
195													195
200													200
205													205
210													210
215													215
220													220
230													230
240													240
250													250

# MLC650 VPC-MAX S-2

ASME B30.5

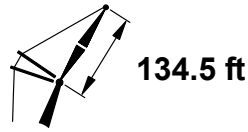
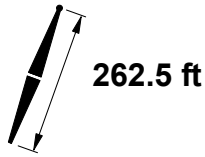
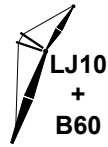

ft	75°				70°				65°				ft
	ft	°	ft	lb	ft	°	ft	lb	ft	°	ft	lb	
75													75
80													80
85													85
90													90
95													95
100													100
105													105
110													110
115													115
120													120
125													125
130													130
135													135
140	63.6	381.9	161,500	278,900									140
145	61.1	379.1	153,900	267,300									145
150	58.6	376.0	146,800	256,600									150
155	56.0	372.5	140,100	246,500									155
160	53.4	368.7	133,900	237,100									160
165	50.6	364.6	128,000	228,300									165
170	47.7	359.9	122,400	220,000	59.5	370.0	98,900	202,300					170
175	44.6	354.8	117,200	212,200	57.0	366.7	94,400	195,000					175
180	41.4	349.1	112,200	204,800	54.3	363.0	90,200	188,200					180
185	37.9	342.6	107,500	197,900	51.6	358.9	86,200	181,800					185
190	34.1	335.3	102,900	191,200	48.7	354.5	82,300	175,600					190
195	29.9	326.6	98,600	185,000	45.8	349.6	78,700	169,900					195
200	25.0	316.2	94,400	179,000	42.6	344.1	75,200	164,300	54.9	354.8	56,100	150,000	200
205	18.7	302.4	90,200	173,200	39.2	337.9	71,900	159,100	52.2	350.8	53,300	145,100	205
210	8.0	277.7	85,800	167,500	35.5	330.9	68,600	154,100	49.4	346.5	50,600	140,500	210
215					31.5	322.8	65,500	149,300	46.4	341.6	48,100	136,100	215
220					26.8	313.1	62,500	144,700	43.3	336.3	45,600	131,900	220
230					13.1	282.4	56,400	135,900	36.4	323.4	40,900	124,000	230
240									27.9	306.3	36,500	116,700	240
250									15.3	278.4	32,000	109,800	250

# MLC650 VPC-MAX S-2

ASME B30.5



661,300 lb



360°

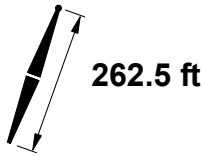

262.5 ft



144.4 ft

ft	85°				83°				80°				ft
	ft	lb	lb	lb	ft	lb	lb	lb	ft	lb	lb	lb	
75	74.1	409.6	298,600 b	298,600 b									75
80	72.0	407.9	297,800 b	297,800 b									80
85	69.9	406.0	296,000	296,000									85
90	67.7	403.8	293,600	293,600	71.6	406.5	300,100	300,100					90
95	65.5	401.5	290,800	290,800	69.5	404.5	299,600	299,600					95
100	63.3	398.9	287,500	287,500	67.3	402.4	298,300	298,300					100
105	61.0	396.1	284,100	284,100	65.1	400.0	296,400	296,400					105
110	58.7	392.9	276,500	276,500	62.9	397.3	282,400	294,000	68.9	401.7	258,700	299,300	110
115	56.3	389.5	265,700	265,700	60.6	394.5	267,100	290,900	66.7	399.5	244,600	299,300	115
120	53.8	385.8	255,100	255,100	58.2	391.3	253,200	287,800	64.5	397.1	231,700	299,300	120
125	51.2	381.7	244,900	244,900	55.8	387.8	240,400	282,700	62.2	394.4	219,800	299,100	125
130	48.6	377.2	235,100	235,100	53.3	384.0	228,600	272,100	59.9	391.4	208,900	297,800	130
135	45.8	372.3	225,900	225,900	50.8	379.9	217,700	261,700	57.6	388.1	198,800	296,000	135
140	42.8	366.8	217,200	217,200	48.1	375.3	207,600	251,700	55.1	384.6	189,400	293,900	140
145	39.7	360.8	209,300	209,300	45.3	370.3	198,100	242,000	52.6	380.7	180,700	287,200	145
150	36.4	354.0	200,500	202,300	42.3	364.8	189,300	232,900	50.0	376.4	172,500	275,700	150
155	32.7	346.2	191,800	196,100	39.1	358.6	181,100	224,500	47.3	371.8	164,900	264,900	155
160	28.6	337.1	183,600	191,100	35.7	351.6	173,300	216,900	44.4	366.6	157,700	254,900	160
165	23.8	326.1	175,800	187,700	32.0	343.6	166,000	210,200	41.4	360.9	151,000	245,500	165
170	17.7	311.6	168,400	186,600	27.8	334.3	159,000	204,700	38.2	354.5	144,600	236,600	170
175	6.7	284.4	160,700	186,600	22.8	322.8	152,400	200,800	34.7	347.3	138,600	228,200	175
180					16.4	307.3	146,000	199,400	30.9	339.0	132,900	220,300	180
185									26.5	329.1	127,400	212,900	185
190									21.2	316.8	122,100	205,800	190
195									13.9	299.2	116,900	198,900	195
200													200
205													205
210													210
215													215
220													220
230													230
240													240
250													250
260													260



# MLC650 VPC-MAX S-2

ASME B30.5

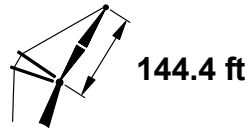
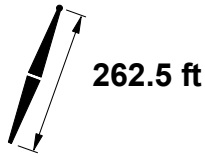

ft	75°				70°				65°				ft
	ft	°	ft	lb	ft	°	ft	lb	ft	°	ft	lb	
75													75
80													80
85													85
90													90
95													95
100													100
105													105
110													110
115													115
120													120
125													125
130													130
135													135
140													140
145	63.3	390.4	151,800	265,500									145
150	61.0	387.6	144,700	254,700									150
155	58.7	384.5	138,100	244,700									155
160	56.3	381.1	131,800	235,300									160
165	53.8	377.3	126,000	226,600									165
170	51.2	373.2	120,500	218,300									170
175	48.6	368.8	115,300	210,500	59.5	378.5	92,200	193,200					175
180	45.8	363.8	110,400	203,200	57.2	375.2	88,000	186,400					180
185	42.9	358.4	105,700	196,300	54.7	371.5	84,000	180,000					185
190	39.7	352.3	101,200	189,800	52.2	367.6	80,300	173,900					190
195	36.4	345.5	97,000	183,500	49.6	363.3	76,700	168,200					195
200	32.7	337.8	92,900	177,600	46.8	358.5	73,200	162,700					200
205	28.6	328.7	89,000	172,000	43.9	353.3	69,900	157,500					205
210	23.8	317.7	85,200	166,600	40.9	347.4	66,800	152,500	52.7	359.4	48,500	138,800	210
215	17.8	303.3	81,400	161,300	37.6	340.9	63,800	147,800	50.1	355.2	46,000	134,400	215
220	7.0	276.5	77,400	156,100	34.1	333.5	60,900	143,300	47.4	350.5	43,600	130,300	220
230					25.7	314.8	55,300	134,800	41.6	339.7	39,000	122,500	230
240					12.2	282.5	49,600	126,700	34.9	326.2	34,700	115,300	240
250									26.7	308.2	30,700	108,600	250
260									14.4	278.8	26,500	102,200	260

# MLC650 VPC-MAX S-2

ASME B30.5



661,300 lb



360°

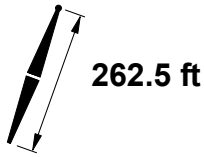

262.5 ft



154.2 ft

ft	85°				83°				80°				ft
	ft	lb	lb	lb	ft	lb	lb	lb	ft	lb	lb	lb	
80	73.2	418.3	278,100 b	278,100 b									80
85	71.2	416.5	277,200	277,200									85
90	69.2	414.5	275,500	275,500	72.8	416.9	279,400	279,400					90
95	67.2	412.4	273,400	273,400	70.9	415.1	279,400	279,400					95
100	65.1	410.0	270,800	270,800	68.9	413.1	279,000	279,000					100
105	63.0	407.4	268,000	268,000	66.8	410.9	277,800	277,800					105
110	60.9	404.5	264,400	264,400	64.8	408.5	276,100	276,100					110
115	58.7	401.4	257,000	257,000	62.7	405.8	264,500	274,100	68.3	410.3	241,500	278,900	115
120	56.5	398.0	247,300	247,300	60.5	402.9	250,600	271,500	66.2	408.0	228,700	278,900	120
125	54.2	394.4	237,800	237,800	58.3	399.8	237,800	269,300	64.2	405.6	216,800	278,900	125
130	51.8	390.4	228,500	228,500	56.1	396.3	226,100	263,800	62.1	402.8	206,000	278,800	130
135	49.3	386.0	219,600	219,600	53.7	392.6	215,200	254,200	59.9	399.9	195,900	277,700	135
140	46.8	381.2	211,200	211,200	51.4	388.6	205,100	244,900	57.7	396.6	186,600	276,300	140
145	44.1	376.0	203,200	203,200	48.9	384.1	195,700	235,700	55.4	393.1	177,900	274,600	145
150	41.2	370.3	195,800	195,800	46.3	379.3	187,000	227,000	53.1	389.3	169,800	272,800	150
155	38.2	363.9	189,100	189,100	43.6	374.0	178,800	218,600	50.7	385.1	162,200	262,700	155
160	35.0	356.7	181,700	183,100	40.7	368.1	171,100	210,800	48.2	380.6	155,100	252,700	160
165	31.4	348.6	174,100	177,900	37.7	361.6	163,800	203,500	45.5	375.6	148,400	243,300	165
170	27.5	339.1	166,800	173,800	34.4	354.3	157,000	197,000	42.8	370.2	142,100	234,500	170
175	22.8	327.6	159,900	171,100	30.8	346.0	150,500	191,300	39.9	364.2	136,200	226,200	175
180	16.8	312.3	153,200	170,500	26.7	336.2	144,300	186,700	36.8	357.4	130,500	218,300	180
185	5.7	282.7	146,300	170,300	21.9	324.2	138,400	183,500	33.4	349.9	125,200	210,900	185
190					15.5	307.9	132,600	182,600	29.7	341.2	120,100	203,900	190
195									25.4	330.9	115,100	197,200	195
200									20.3	318.0	110,400	190,800	200
205									13.1	299.4	105,600	184,700	205
210													210
215													215
220													220
230													230
240													240
250													250
260													260
270													270

# MLC650 VPC-MAX S-2

ASME B30.5

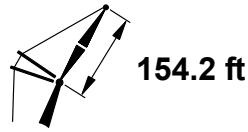
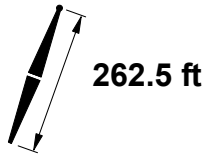
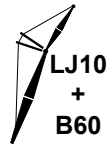

ft	75°				70°				65°				ft
	ft	°	ft	lb	ft	°	ft	lb	ft	°	ft	lb	
80													80
85													85
90													90
95													95
100													100
105													105
110													110
115													115
120													120
125													125
130													130
135													135
140													140
145													145
150	63.1	398.9	141,500	252,100									150
155	60.9	396.1	134,900	242,100									155
160	58.7	393.0	128,700	232,800									160
165	56.5	389.6	122,900	224,100									165
170	54.2	385.9	117,500	215,900									170
175	51.8	381.9	112,300	208,100									175
180	49.3	377.5	107,500	200,900	59.5	386.9	84,700	183,800					180
185	46.8	372.8	102,800	194,000	57.3	383.7	80,800	177,400					185
190	44.1	367.6	98,500	187,500	55.0	380.1	77,000	171,400					190
195	41.3	361.8	94,300	181,300	52.7	376.2	73,500	165,700					195
200	38.3	355.4	90,300	175,400	50.2	372.0	70,100	160,200					200
205	35.0	348.3	86,500	169,900	47.7	367.4	66,900	155,100					205
210	31.5	340.2	82,800	164,500	45.1	362.3	63,800	150,200					210
215	27.5	330.7	79,200	159,400	42.3	356.8	60,800	145,500	53.2	368.0	42,600	131,800	215
220	22.8	319.2	75,800	154,500	39.4	350.7	58,000	141,000	50.8	363.9	40,300	127,700	220
230	5.9	275.0	68,600	145,000	32.8	336.1	52,600	132,600	45.7	354.4	35,800	120,000	230
240					24.6	316.5	47,500	124,800	40.0	343.0	31,700	112,900	240
250					11.4	282.4	42,300	117,400	33.6	328.8	27,800	106,300	250
260									25.6	310.0	24,000	100,200	260
270									13.6	279.1	20,200	94,300	270

# MLC650 VPC-MAX S-2

ASME B30.5

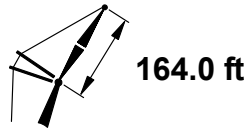
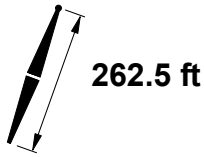

ft	85°				83°				80°				ft
	ft	lb	lb	lb	ft	lb	lb	lb	ft	lb	lb	lb	
80	74.2	428.6	261,300	261,300									80
85	72.4	427.0	260,900	260,900									85
90	70.5	425.1	259,800	259,800									90
95	68.6	423.1	258,200	258,200	72.1	425.6	262,200	262,200					95
100	66.7	420.9	256,200	256,200	70.2	423.7	262,200	262,200					100
105	64.8	418.5	253,800	253,800	68.3	421.7	261,600	261,600					105
110	62.8	415.9	250,800	250,800	66.4	419.4	260,500	260,500					110
115	60.8	413.0	247,900	247,900	64.4	417.0	258,900	258,900	69.7	421.0	240,600	260,300	115
120	58.8	409.9	239,600	239,600	62.5	414.3	249,900	257,100	67.8	418.9	227,800	260,300	120
125	56.7	406.6	230,800	230,800	60.5	411.4	237,200	255,100	65.8	416.6	216,000	260,300	125
130	54.5	402.9	222,100	222,100	58.4	408.3	225,400	252,500	63.9	414.0	205,100	260,300	130
135	52.3	399.0	213,700	213,700	56.3	404.9	214,600	246,800	61.9	411.3	195,100	260,300	135
140	50.0	394.7	205,500	205,500	54.1	401.2	204,500	238,100	59.9	408.3	185,800	260,300	140
145	47.6	390.1	197,700	197,700	51.9	397.2	195,200	229,500	57.8	405.1	177,200	259,300	145
150	45.1	385.1	190,300	190,300	49.6	392.9	186,500	221,200	55.7	401.7	169,100	257,800	150
155	42.5	379.6	183,400	183,400	47.2	388.2	178,300	213,100	53.5	397.9	161,500	256,200	155
160	39.8	373.5	177,000	177,000	44.7	383.1	170,700	205,300	51.2	393.8	154,500	251,900	160
165	36.9	366.9	171,200	171,200	42.1	377.5	163,500	198,000	48.9	389.4	147,800	242,500	165
170	33.7	359.4	166,100	166,100	39.3	371.3	156,700	191,100	46.5	384.6	141,600	233,800	170
175	30.3	350.9	160,000	161,700	36.3	364.5	150,300	184,800	44.0	379.4	135,700	225,500	175
180	26.4	341.0	153,500	158,100	33.2	356.9	144,200	179,100	41.3	373.6	130,100	217,700	180
185	21.9	329.0	147,400	155,900	29.6	348.2	138,400	174,200	38.5	367.3	124,800	210,300	185
190	16.0	313.0	141,400	155,600	25.7	338.0	132,900	170,300	35.5	360.3	119,700	203,400	190
195	4.5	280.4	135,100	155,600	21.0	325.5	127,500	167,600	32.2	352.4	114,900	196,700	195
200					14.7	308.4	122,300	167,000	28.6	343.3	110,300	190,400	200
205									24.4	332.5	105,800	184,400	205
210									19.4	319.1	101,500	178,700	210
215									12.4	299.6	97,200	173,100	215
220													220
230													230
240													240
250													250
260													260
270													270
280													280

# MLC650 VPC-MAX S-2

ASME B30.5

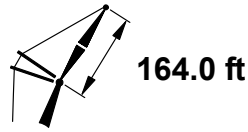
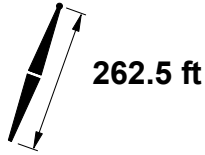

ft	75°				70°				65°				ft
	ft	°	ft	lb	ft	°	ft	lb	ft	°	ft	lb	
80													80
85													85
90													90
95													95
100													100
105													105
110													110
115													115
120													120
125													125
130													130
135													135
140													140
145													145
150	64.8	410.0	140,500	251,100									150
155	62.8	407.4	133,900	241,100									155
160	60.8	404.5	127,800	231,900									160
165	58.8	401.4	122,000	223,200									165
170	56.7	398.1	116,600	215,000									170
175	54.5	394.5	111,500	207,300									175
180	52.3	390.5	106,700	200,100									180
185	50.0	386.3	102,100	193,200	59.5	395.4	79,700	176,500					185
190	47.6	381.7	97,700	186,700	57.4	392.2	76,000	170,500					190
195	45.2	376.6	93,600	180,600	55.3	388.6	72,500	164,800					195
200	42.6	371.1	89,600	174,800	53.1	384.8	69,200	159,400					200
205	39.8	365.1	85,900	169,200	50.8	380.7	66,000	154,300					205
210	36.9	358.4	82,300	163,900	48.5	376.2	62,900	149,400					210
215	33.8	350.9	78,800	158,900	46.1	371.3	60,000	144,700					215
220	30.3	342.5	75,500	154,100	43.5	366.0	57,200	140,300	53.6	376.6	39,200	126,800	220
230	21.9	320.6	69,100	145,000	38.0	353.7	51,900	132,000	49.0	368.2	34,900	119,200	230
240	4.8	272.9	62,400	136,300	31.6	338.5	47,000	124,300	44.1	358.2	30,800	112,100	240
250					23.7	318.1	42,300	117,200	38.6	346.2	27,000	105,600	250
260					10.7	282.3	37,500	110,300	32.4	331.3	23,400	99,600	260
270									24.7	311.6	20,000	93,900	270
280									12.8	279.3		88,500	280

# MLC650 VPC-MAX S-2

ASME B30.5



661,300 lb



360°

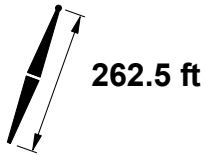

262.5 ft

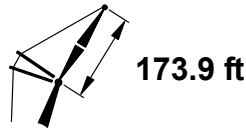

173.9 ft

ft	85°				83°				80°				ft
	ft	lb	lb	lb	ft	lb	lb	lb	ft	lb	lb	lb	
85	73.4	437.3	245,000	245,000									85
90	71.7	435.6	244,300	244,300									90
95	69.9	433.7	243,200	243,200									95
100	68.1	431.7	241,700	241,700	71.4	434.2	245,900	245,900					100
105	66.3	429.4	239,900	239,900	69.6	432.3	245,700	245,700					105
110	64.5	427.0	237,700	237,700	67.8	430.2	245,000	245,000					110
115	62.6	424.3	235,500	235,500	66.0	427.9	244,000	244,000					115
120	60.7	421.5	231,100	231,100	64.2	425.5	242,700	242,700	69.1	429.6	224,700	244,000	120
125	58.8	418.4	223,100	223,100	62.3	422.8	234,500	241,100	67.3	427.4	213,000	244,000	125
130	56.8	415.1	215,100	215,100	60.4	419.9	222,800	239,300	65.5	425.1	202,200	244,000	130
135	54.8	411.5	207,300	207,300	58.5	416.8	212,000	237,000	63.6	422.5	192,200	244,000	135
140	52.7	407.6	199,600	199,600	56.5	413.4	202,000	230,600	61.8	419.8	183,000	244,000	140
145	50.6	403.4	192,200	192,200	54.4	409.7	192,700	222,800	59.9	416.8	174,300	244,000	145
150	48.3	398.9	185,100	185,100	52.3	405.8	184,000	215,000	57.9	413.6	166,300	243,200	150
155	46.0	394.1	178,300	178,300	50.2	401.6	175,900	207,400	55.9	410.2	158,800	242,000	155
160	43.6	388.8	171,900	171,900	47.9	397.0	168,300	200,000	53.8	406.5	151,800	240,700	160
165	41.1	383.0	165,900	165,900	45.6	392.1	161,100	192,900	51.7	402.5	145,200	237,300	165
170	38.5	376.7	160,500	160,500	43.2	386.7	154,400	186,100	49.6	398.2	139,000	229,700	170
175	35.7	369.7	155,500	155,500	40.7	380.9	148,000	179,700	47.3	393.5	133,100	222,200	175
180	32.6	361.9	151,100	151,100	38.0	374.4	142,000	173,700	45.0	388.4	127,500	214,700	180
185	29.2	353.0	145,600	147,300	35.1	367.3	136,300	168,200	42.5	382.9	122,300	207,600	185
190	25.5	342.8	139,800	144,500	32.0	359.4	130,800	163,400	39.9	376.9	117,300	200,700	190
195	21.0	330.2	134,200	142,700	28.6	350.3	125,600	159,200	37.2	370.3	112,500	194,200	195
200	15.3	313.6	128,800	142,700	24.8	339.7	120,600	155,900	34.3	363.0	108,000	188,100	200
205	2.9	276.3	123,000	140,100	20.2	326.6	115,800	153,700	31.1	354.7	103,700	182,500	205
210					14.0	308.8	111,100	153,600	27.6	345.3	99,500	176,900	210
215									23.6	334.1	95,500	171,400	215
220									18.7	320.1	91,500	166,200	220
230													230
240													240
250													250
260													260
270													270
280													280
290													290

# MLC650 VPC-MAX S-2

ASME B30.5

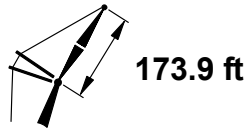
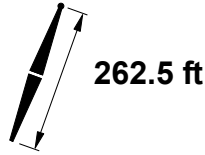

ft	75°				70°				65°			ft
	ft	ft	lb	lb	ft	lb	lb	ft	lb	ft		
85												85
90												90
95												95
100												100
105												105
110												110
115												115
120												120
125												125
130												130
135												135
140												140
145												145
150												150
155	64.5	418.5	130,700	235,500								155
160	62.7	415.9	124,600	229,300								160
165	60.8	413.0	118,900	220,600								165
170	58.8	409.9	113,500	212,500								170
175	56.8	406.6	108,500	204,900								175
180	54.8	403.0	103,700	197,700								180
185	52.7	399.1	99,100	190,800								185
190	50.6	395.0	94,800	184,400	59.5	403.9	72,700	167,900				190
195	48.4	390.5	90,700	178,300	57.6	400.6	69,300	162,200				195
200	46.1	385.6	86,800	172,500	55.5	397.2	66,000	156,900				200
205	43.7	380.3	83,100	167,000	53.5	393.4	62,800	151,800				205
210	41.2	374.6	79,600	161,800	51.4	389.3	59,800	146,900				210
215	38.5	368.2	76,200	156,800	49.2	385.0	56,900	142,300				215
220	35.7	361.3	72,900	152,000	46.9	380.2	54,200	137,900				220
230	29.3	344.6	66,700	143,000	42.1	369.5	49,000	129,600	51.8	381.2	116,600	230
240	21.1	321.9	60,900	134,700	36.7	356.7	44,200	122,100	47.4	372.3	109,600	240
250	3.5	269.6	54,600	126,700	30.5	340.8	39,700	115,100	42.6	361.7	103,200	250
260					22.8	319.5	35,400	108,500	37.3	349.2	97,300	260
270					10.0	282.0	30,900	102,200	31.3	333.7	91,700	270
280									23.8	313.2	86,500	280
290									12.1	279.4	81,400	290

# MLC650 VPC-MAX S-2

ASME B30.5



661,300 lb

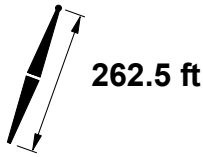

262.5 ft



193.6 ft

ft	85°				83°				80°				ft
	ft	lb	lb	lb	ft	lb	lb	lb	ft	lb	lb	lb	
90	73.6	456.4	216,000	216,000									90
95	72.0	454.7	215,600	215,600									95
100	70.5	452.9	214,900	214,900									100
105	68.9	450.9	213,800	213,800	71.8	453.4	216,300	216,300					105
110	67.3	448.8	212,500	212,500	70.2	451.5	216,300	216,300					110
115	65.6	446.5	211,000	211,000	68.6	449.5	216,100	216,100					115
120	64.0	444.0	209,300	209,300	67.0	447.3	215,500	215,500					120
125	62.3	441.3	207,000	207,000	65.4	445.0	214,600	214,600	69.7	448.8	209,000	213,400	125
130	60.6	438.4	201,300	201,300	63.7	442.4	213,600	213,600	68.1	446.7	198,300	213,400	130
135	58.9	435.4	194,800	194,800	62.0	439.7	208,600	212,300	66.5	444.5	188,300	213,400	135
140	57.1	432.1	188,200	188,200	60.3	436.8	198,700	211,000	64.9	442.1	179,100	213,400	140
145	55.3	428.5	181,700	181,700	58.6	433.7	189,400	209,100	63.2	439.5	170,600	213,400	145
150	53.4	424.8	175,300	175,300	56.8	430.4	180,800	202,700	61.5	436.7	162,600	213,400	150
155	51.5	420.8	169,100	169,100	55.0	426.8	172,700	196,200	59.8	433.8	155,200	213,400	155
160	49.6	416.5	163,200	163,200	53.1	423.0	165,100	189,800	58.1	430.6	148,200	213,400	160
165	47.6	411.8	157,400	157,400	51.2	419.0	158,000	183,300	56.3	427.2	141,700	213,400	165
170	45.5	406.9	151,900	151,900	49.2	414.6	151,300	177,200	54.4	423.6	135,500	212,400	170
175	43.3	401.5	146,800	146,800	47.2	409.9	145,000	171,100	52.6	419.7	129,700	210,500	175
180	41.1	395.7	141,900	141,900	45.1	404.9	139,100	165,300	50.6	415.6	124,200	204,200	180
185	38.7	389.5	137,300	137,300	42.9	399.5	133,400	159,800	48.7	411.1	119,000	198,000	185
190	36.2	382.6	133,200	133,200	40.6	393.6	128,100	154,500	46.6	406.3	114,100	191,800	190
195	33.5	375.1	129,500	129,500	38.2	387.2	123,000	149,600	44.5	401.2	109,400	185,600	195
200	30.6	366.7	126,200	126,200	35.7	380.3	118,200	145,000	42.3	395.7	104,900	179,700	200
205	27.4	357.1	122,100	123,500	33.0	372.6	113,500	140,900	40.0	389.7	100,700	174,000	205
210	23.8	346.0	117,400	121,500	30.1	364.0	109,100	137,200	37.6	383.1	96,600	168,600	210
215	19.6	332.6	112,800	120,400	26.8	354.2	104,800	134,000	35.0	376.0	92,800	163,500	215
220	14.0	314.5	108,300	120,400	23.1	342.8	100,700	131,700	32.2	368.1	89,000	158,800	220
230					12.8	309.3	92,800	130,300	25.8	349.0	82,000	150,800	230
240									17.3	321.9	75,300	145,400	240
250													250
260													260
270													270
280													280
290													290
300													300
310													310



# MLC650 VPC-MAX S-2

ASME B30.5

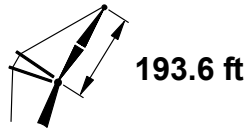
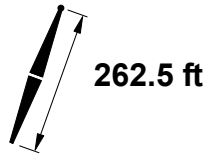

ft	75°				70°				65°			ft
	ft	ft	lb	lb	ft	ft	lb	lb	ft	lb		
90												90
95												95
100												100
105												105
110												110
115												115
120												120
125												125
130												130
135												135
140												140
145												145
150												150
155												155
160												160
165	64.0	435.5	114,700	205,700								165
170	62.3	432.8	109,400	205,700								170
175	60.6	430.0	104,400	201,500								175
180	58.9	426.9	99,700	194,300								180
185	57.1	423.6	95,200	187,600								185
190	55.3	420.1	90,900	181,200								190
195	53.5	416.3	86,900	175,100								195
200	51.6	412.3	83,100	169,400	59.5	420.8	61,600	153,400				200
205	49.6	408.0	79,400	163,900	57.8	417.6	58,500	148,300				205
210	47.6	403.4	75,900	158,700	56.0	414.2	55,600	143,500				210
215	45.5	398.4	72,600	153,800	54.1	410.5	52,800	139,000				215
220	43.3	393.1	69,400	149,100	52.2	406.6	50,100	134,600				220
230	38.7	381.0	63,400	140,300	48.3	397.9	45,000	126,500				230
240	33.5	366.6	57,900	132,100	44.1	387.9	40,400	119,000	52.7	398.5	106,200	240
250	27.4	348.7	52,700	124,700	39.6	376.2	36,100	112,100	48.8	389.9	99,900	250
260	19.6	324.2	47,700	117,700	34.5	362.3	32,000	105,800	44.6	380.0	94,100	260
270					28.6	345.1	28,200	99,800	40.1	368.5	88,700	270
280					21.2	322.3	24,500	94,200	35.1	354.9	83,600	280
290					8.7	281.0	20,600	88,800	29.3	338.2	78,800	290
300									22.2	316.2	74,300	300
310									10.9	279.4	69,900	310

# MLC650 VPC-MAX S-2

ASME B30.5



661,300 lb

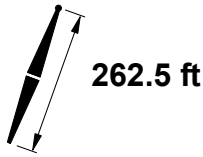

262.5 ft

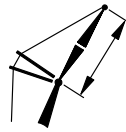

213.3 ft

ft	85°				83°				80°				ft
	ft	lb	lb	lb	ft	lb	lb	lb	ft	lb	lb	lb	
95	73.8	475.5	188,900	188,900									95
100	72.4	473.8	188,700	188,700									100
105	70.9	472.1	188,200	188,200									105
110	69.5	470.1	187,500	187,500	72.1	472.5	189,000	189,000					110
115	68.0	468.1	186,600	186,600	70.7	470.7	189,000	189,000					115
120	66.6	465.9	185,500	185,500	69.2	468.7	189,000	189,000					120
125	65.1	463.5	184,300	184,300	67.8	466.6	188,700	188,700					125
130	63.6	461.0	182,600	182,600	66.3	464.4	188,200	188,200					130
135	62.0	458.3	181,100	181,100	64.8	462.0	187,400	187,400	68.8	465.9	184,500	186,700	135
140	60.5	455.4	176,100	176,100	63.3	459.4	186,600	186,600	67.4	463.8	175,300	186,700	140
145	58.9	452.3	170,700	170,700	61.8	456.7	185,600	185,600	65.9	461.5	166,800	186,700	145
150	57.3	449.1	165,400	165,400	60.2	453.8	177,500	184,500	64.4	459.1	158,900	186,700	150
155	55.7	445.6	160,100	160,100	58.6	450.7	169,400	183,300	62.9	456.5	151,500	186,700	155
160	54.0	441.9	154,800	154,800	57.0	447.4	161,900	178,600	61.3	453.7	144,600	186,700	160
165	52.3	438.0	149,700	149,700	55.4	443.9	154,800	173,300	59.8	450.7	138,100	186,700	165
170	50.6	433.9	144,700	144,700	53.7	440.2	148,200	168,100	58.2	447.6	131,900	186,700	170
175	48.8	429.4	139,900	139,900	52.0	436.2	141,900	162,800	56.6	444.2	126,200	186,700	175
180	46.9	424.7	135,200	135,200	50.3	432.0	136,000	157,700	54.9	440.7	120,700	186,700	180
185	45.0	419.7	130,700	130,700	48.5	427.5	130,400	152,600	53.2	436.9	115,600	186,000	185
190	43.0	414.3	126,500	126,500	46.6	422.8	125,100	147,800	51.5	432.9	110,700	181,800	190
195	41.0	408.5	122,500	122,500	44.7	417.7	120,100	143,000	49.8	428.6	106,100	176,800	195
200	38.8	402.3	118,800	118,800	42.7	412.2	115,300	138,500	47.9	424.0	101,700	171,600	200
205	36.6	395.5	115,300	115,300	40.6	406.4	110,700	134,100	46.1	419.2	97,500	166,600	205
210	34.2	388.1	112,100	112,100	38.5	400.0	106,400	130,100	44.1	414.0	93,500	161,700	210
215	31.6	380.1	109,300	109,300	36.2	393.2	102,200	126,200	42.1	408.4	89,600	156,700	215
220	28.9	371.1	106,400	106,800	33.8	385.7	98,200	122,700	40.0	402.4	86,000	152,100	220
230	22.4	349.0	98,400	103,400	28.4	368.3	90,700	116,600	35.5	388.9	79,100	143,300	230
240	12.9	315.1	90,700	102,700	21.7	345.7	83,700	112,400	30.4	372.8	72,800	135,500	240
250					11.6	309.6	76,900	111,500	24.3	352.4	66,800	129,300	250
260									16.0	323.4	61,100	125,600	260
270													270
280													280
290													290
300													300
310													310
320													320
330													330

# MLC650 VPC-MAX S-2

ASME B30.5

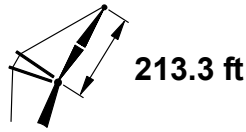
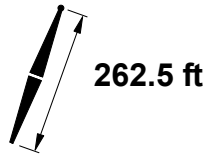
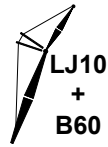

ft	75°				70°				65°					
	ft	°	ft	lb	ft	°	ft	lb	ft	°	ft	lb	ft	
95														95
100														100
105														105
110														110
115														115
120														120
125														125
130														130
135														135
140														140
145														145
150														150
155														155
160														160
165														165
170														170
175	63.6	452.5	100,300	179,500										175
180	62.1	449.8	95,600	179,500										180
185	60.5	446.9	91,200	179,500										185
190	58.9	443.8	87,000	177,900										190
195	57.3	440.6	83,000	171,900										195
200	55.7	437.1	79,200	166,200										200
205	54.0	433.5	75,600	160,800										205
210	52.3	429.5	72,200	155,700	59.5	437.8	51,300	140,100						210
215	50.6	425.4	68,900	150,800	57.9	434.6	48,600	135,600						215
220	48.8	421.0	65,800	146,100	56.3	431.2	45,900	131,300						220
230	45.0	411.2	59,900	137,400	53.0	423.8	41,000	123,200						230
240	41.0	400.0	54,500	129,300	49.4	415.4	36,400	115,900						240
250	36.6	387.1	49,400	122,000	45.7	405.9	32,200	109,100	53.3	415.6	96,600			250
260	31.7	371.6	44,800	115,100	41.8	395.0	28,300	102,800	49.8	407.4	90,800			260
270	25.9	352.5	40,300	108,800	37.4	382.4	24,700	97,000	46.2	398.0	85,500			270
280	18.3	326.3	36,000	102,800	32.6	367.5	21,200	91,500	42.2	387.2	80,500			280
290					27.0	349.1		86,500	37.9	374.8	75,900			290
300					19.9	324.7		81,600	33.2	360.2	71,500			300
310					7.4	279.5		76,900	27.7	342.3	67,400			310
320									20.8	318.8	63,500			320
330									9.7	278.9	59,600			330

# MLC650 VPC-MAX S-2

ASME B30.5



661,300 lb

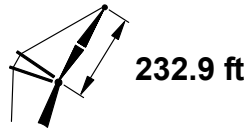
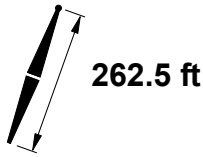

ft	85°				83°				80°				ft
	ft	lb	lb	lb	ft	lb	lb	lb	ft	lb	lb	lb	
100	73.9	494.5	166,700	166,700									100
105	72.6	492.9	166,600	166,600									105
110	71.3	491.2	166,200	166,200									110
115	70.0	489.3	165,700	165,700	72.4	491.6	166,200	166,200					115
120	68.7	487.3	164,900	164,900	71.1	489.8	166,200	166,200					120
125	67.3	485.2	164,000	164,000	69.8	487.9	166,200	166,200					125
130	66.0	482.9	163,000	163,000	68.4	485.9	166,200	166,200					130
135	64.6	480.5	161,900	161,900	67.1	483.7	165,900	165,900					135
140	63.2	477.9	160,700	160,700	65.7	481.4	165,400	165,400	69.4	485.2	163,200	163,200	140
145	61.8	475.2	159,400	159,400	64.4	479.0	164,900	164,900	68.1	483.1	163,200	163,200	145
150	60.4	472.3	155,000	155,000	63.0	476.4	164,100	164,100	66.7	480.9	156,200	163,200	150
155	59.0	469.3	150,600	150,600	61.6	473.6	163,400	163,400	65.4	478.6	148,900	163,200	155
160	57.5	466.0	146,100	146,100	60.2	470.7	159,600	162,500	64.0	476.1	142,000	163,200	160
165	56.0	462.6	141,700	141,700	58.7	467.7	152,600	161,400	62.6	473.4	135,500	163,200	165
170	54.5	459.0	137,300	137,300	57.2	464.4	146,000	158,300	61.2	470.6	129,400	163,200	170
175	53.0	455.2	133,000	133,000	55.8	460.9	139,800	153,900	59.8	467.7	123,700	163,200	175
180	51.4	451.2	128,900	128,900	54.2	457.3	133,900	149,600	58.3	464.6	118,300	163,200	180
185	49.8	446.9	124,700	124,700	52.7	453.4	128,300	145,200	56.8	461.2	113,200	163,200	185
190	48.1	442.4	120,700	120,700	51.1	449.4	123,000	140,900	55.3	457.7	108,300	163,200	190
195	46.4	437.6	116,900	116,900	49.5	445.0	118,000	136,600	53.8	454.0	103,700	163,200	195
200	44.6	432.5	113,300	113,300	47.8	440.5	113,300	132,500	52.2	450.1	99,300	162,600	200
205	42.8	427.0	109,800	109,800	46.1	435.6	108,800	128,500	50.6	446.0	95,200	158,400	205
210	40.9	421.2	106,500	106,500	44.3	430.5	104,400	124,500	49.0	441.6	91,200	154,200	210
215	39.0	415.0	103,300	103,300	42.5	425.0	100,300	120,700	47.3	436.9	87,400	150,000	215
220	36.9	408.4	100,400	100,400	40.6	419.1	96,400	117,100	45.6	432.0	83,800	145,800	220
230	32.5	393.3	95,200	95,200	36.6	406.1	89,000	110,400	42.0	421.2	77,100	137,600	230
240	27.4	375.1	89,800	91,200	32.1	390.8	82,200	104,600	38.1	408.8	70,800	129,900	240
250	21.1	351.8	83,000	88,600	26.9	372.3	75,900	99,900	33.7	394.4	65,100	122,800	250
260	11.9	315.5	76,500	88,200	20.5	348.2	69,900	96,800	28.9	377.2	59,700	116,600	260
270					10.6	309.5	64,100	96,200	23.0	355.6	54,600	111,700	270
280									15.0	324.6	49,700	109,000	280
290													290
300													300
310													310
320													320
330													330
340													340
350													350

# MLC650 VPC-MAX S-2

ASME B30.5

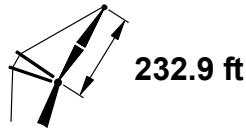
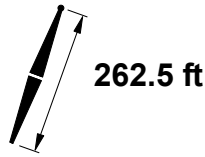
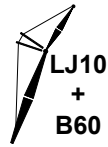

ft	75°				70°				65°				
	ft	°	ft	lb	ft	°	ft	lb	ft	°	ft	lb	
100													100
105													105
110													110
115													115
120													120
125													125
130													130
135													135
140													140
145													145
150													150
155													155
160													160
165													165
170													170
175													175
180	64.6	472.0	92,700	154,700									180
185	63.2	469.5	88,300	154,700									185
190	61.8	466.7	84,100	154,700									190
195	60.4	463.9	80,200	154,700									195
200	59.0	460.8	76,400	154,700									200
205	57.5	457.6	72,900	154,700									205
210	56.0	454.2	69,500	153,400									210
215	54.5	450.6	66,200	148,500									215
220	53.0	446.7	63,100	143,900	59.5	454.8	42,900	128,800					220
230	49.8	438.4	57,300	135,200	56.6	448.2	38,000	120,900					230
240	46.4	429.1	52,000	127,300	53.5	441.0	33,600	113,500					240
250	42.8	418.6	47,100	120,000	50.4	432.8	29,400	106,800					250
260	39.0	406.6	42,500	113,200	47.0	423.7	25,600	100,600	53.9	432.8	88,400		260
270	34.8	392.7	38,200	107,000	43.5	413.4	22,100	94,900	50.7	424.7	83,100		270
280	30.1	376.3	34,200	101,100	39.7	401.7		89,500	47.4	415.7	78,200		280
290	24.5	356.0	30,400	95,700	35.6	388.2		84,500	43.9	405.6	73,700		290
300	17.2	328.1	26,700	90,500	31.0	372.3		79,800	40.1	394.0	69,400		300
310					25.6	352.8		75,400	36.1	380.8	65,400		310
320					18.7	326.9		71,200	31.5	365.2	61,600		320
330					6.3	277.3		67,000	26.2	346.2	58,000		330
340									19.6	321.2	54,500		340
350									8.7	278.0	51,100		350

# MLC650 VPC-MAX S-2

ASME B30.5



661,300 lb



360°

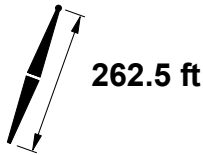

262.5 ft

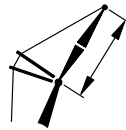

252.6 ft

ft	85°				83°				80°				ft
	ft	lb	lb	lb	ft	lb	lb	lb	ft	lb	lb	lb	
105	74.0	513.6	146,400	146,400									105
110	72.8	512.0	146,200	146,200									110
115	71.6	510.3	145,900	145,900									115
120	70.4	508.5	145,400	145,400	72.6	510.6	145,700	145,700					120
125	69.2	506.5	144,900	144,900	71.4	508.9	145,700	145,700					125
130	68.0	504.5	144,200	144,200	70.2	507.1	145,700	145,700					130
135	66.7	502.3	143,400	143,400	69.0	505.1	145,700	145,700					135
140	65.5	500.0	142,500	142,500	67.8	503.0	145,400	145,400					140
145	64.2	497.5	141,600	141,600	66.5	500.8	145,000	145,000	69.9	504.3	142,500	142,500	145
150	62.9	494.9	140,600	140,600	65.3	498.5	144,600	144,600	68.6	502.3	142,500	142,500	150
155	61.6	492.2	139,300	139,300	64.0	496.0	144,000	144,000	67.4	500.2	142,500	142,500	155
160	60.3	489.3	135,700	135,700	62.7	493.4	143,400	143,400	66.2	498.0	138,000	142,500	160
165	59.0	486.2	132,000	132,000	61.4	490.6	142,700	142,700	64.9	495.6	131,500	142,500	165
170	57.7	483.0	128,300	128,300	60.1	487.7	142,000	142,000	63.6	493.1	125,500	142,500	170
175	56.3	479.7	124,600	124,600	58.8	484.6	136,200	141,200	62.4	490.4	119,800	142,500	175
180	54.9	476.1	121,000	121,000	57.4	481.4	130,300	139,300	61.1	487.6	114,400	142,500	180
185	53.5	472.4	117,400	117,400	56.1	478.0	124,800	135,700	59.7	484.6	109,300	142,500	185
190	52.0	468.4	113,900	113,900	54.7	474.4	119,500	132,100	58.4	481.5	104,500	142,500	190
195	50.6	464.3	110,400	110,400	53.2	470.6	114,600	128,500	57.0	478.2	99,900	142,500	195
200	49.1	459.9	107,100	107,100	51.8	466.6	109,800	124,900	55.7	474.8	95,600	142,500	200
205	47.5	455.3	103,800	103,800	50.3	462.4	105,300	121,400	54.3	471.1	91,500	142,500	205
210	45.9	450.4	100,600	100,600	48.8	458.0	101,100	117,800	52.8	467.3	87,500	142,200	210
215	44.3	445.2	97,600	97,600	47.2	453.4	97,000	114,500	51.4	463.3	83,800	140,900	215
220	42.6	439.8	94,700	94,700	45.7	448.4	93,100	111,100	49.9	459.0	80,200	137,400	220
230	39.1	427.8	89,300	89,300	42.3	437.7	85,800	104,700	46.8	449.8	73,500	130,400	230
240	35.2	414.1	84,600	84,600	38.8	425.6	79,100	98,800	43.5	439.5	67,400	123,500	240
250	31.0	398.2	80,300	80,600	34.9	411.7	72,900	93,600	40.1	427.9	61,700	116,900	250
260	26.1	379.0	74,200	77,500	30.6	395.6	67,100	89,000	36.3	414.7	56,400	110,600	260
270	20.0	354.3	68,400	75,700	25.6	376.0	61,700	85,400	32.2	399.5	51,500	105,000	270
280	10.9	315.5	62,800	75,600	19.4	350.6	56,500	83,100	27.5	381.3	46,900	100,100	280
290					9.7	309.0	51,400	82,800	21.8	358.5	42,500	96,200	290
300									14.0	325.6	38,200	94,300	300
310													310
320													320
330													330
340													340
350													350
360													360
370													370

# MLC650 VPC-MAX S-2

ASME B30.5

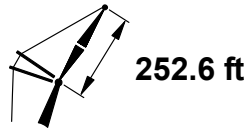
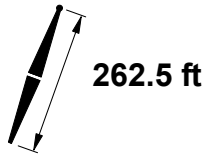

ft	75°				70°			65°			ft
	ft	lb	lb	lb	ft	lb	ft	lb	lb		
105											105
110											110
115											115
120											120
125											125
130											130
135											135
140											140
145											145
150											150
155											155
160											160
165											165
170											170
175											175
180											180
185											185
190	64.2	489.0	79,800	134,800							190
195	63.0	486.4	75,900	134,800							195
200	61.7	483.7	72,200	134,800							200
205	60.4	480.8	68,700	134,800							205
210	59.0	477.8	65,300	134,800							210
215	57.7	474.6	62,100	134,800							215
220	56.3	471.2	59,100	134,800							220
230	53.5	463.9	53,300	132,000	59.5	471.7	117,400				230
240	50.6	455.8	48,100	124,200	56.8	465.3	110,100				240
250	47.5	446.8	43,200	116,900	54.0	458.1	103,500				250
260	44.3	436.8	38,800	110,200	51.1	450.2	97,300				260
270	40.9	425.5	34,600	104,000	48.1	441.3	91,700	54.3	449.9	79,700	270
280	37.2	412.8	30,700	98,300	44.9	431.5	86,400	51.4	442.0	74,800	280
290	33.2	398.0	27,000	92,900	41.5	420.5	81,500	48.4	433.3	70,300	290
300	28.6	380.7	23,500	87,900	37.9	408.0	76,800	45.3	423.6	66,100	300
310	23.3	359.2	20,200	83,100	34.0	393.7	72,500	41.9	412.7	62,200	310
320	16.2	329.7		78,600	29.5	376.9	68,400	38.3	400.4	58,500	320
330					24.3	356.3	64,600	34.4	386.3	55,000	330
340					17.7	328.8	60,900	30.0	369.8	51,700	340
350					5.1	274.2	57,100	24.9	349.7	48,500	350
360								18.5	323.3	45,400	360
370								7.7	276.7	42,300	370

# MLC650 VPC-MAX S-2

ASME B30.5



661,300 lb

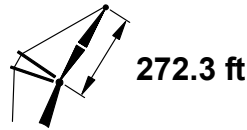
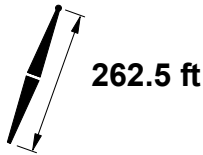

ft	85°				83°				80°				ft
	ft	lb	lb	lb	ft	lb	lb	lb	ft	lb	lb	lb	
110	74.1	532.6	129,300	129,300									110
115	73.0	531.1	129,100	129,100									115
120	71.9	529.4	128,700	128,700									120
125	70.8	527.6	128,300	128,300	72.8	529.7	128,500	128,500					125
130	69.6	525.7	127,700	127,700	71.7	528.0	128,500	128,500					130
135	68.5	523.7	126,800	126,800	70.6	526.2	128,500	128,500					135
140	67.4	521.6	126,200	126,200	69.4	524.3	128,100	128,100					140
145	66.2	519.4	125,700	125,700	68.3	522.3	128,100	128,100					145
150	65.1	517.0	124,900	124,900	67.2	520.1	127,500	127,500					150
155	63.9	514.5	123,900	123,900	66.0	517.9	127,100	127,100	69.1	521.5	125,700	125,700	155
160	62.7	511.9	123,000	123,000	64.8	515.5	126,700	126,700	68.0	519.5	125,700	125,700	160
165	61.5	509.1	122,100	122,100	63.7	513.0	126,200	126,200	66.8	517.3	125,700	125,700	165
170	60.3	506.2	119,100	119,100	62.5	510.3	125,600	125,600	65.7	515.0	122,800	125,700	170
175	59.0	503.2	116,000	116,000	61.3	507.6	125,000	125,000	64.5	512.6	117,100	125,700	175
180	57.8	500.0	113,000	113,000	60.1	504.6	124,400	124,400	63.3	510.0	111,800	125,700	180
185	56.5	496.7	109,900	109,900	58.8	501.6	122,500	123,700	62.1	507.4	106,700	125,700	185
190	55.2	493.2	106,900	106,900	57.6	498.4	117,300	123,000	60.9	504.6	102,000	125,700	190
195	53.9	489.5	103,900	103,900	56.3	495.0	112,300	120,000	59.7	501.6	97,400	125,700	195
200	52.6	485.6	100,900	100,900	55.0	491.5	107,600	117,000	58.5	498.5	93,100	125,700	200
205	51.3	481.6	98,000	98,000	53.7	487.7	103,200	113,900	57.2	495.2	89,000	125,400	205
210	49.9	477.3	95,200	95,200	52.4	483.9	98,900	110,900	55.9	491.8	85,100	125,100	210
215	48.5	472.9	92,400	92,400	51.0	479.8	94,900	108,000	54.7	488.2	81,400	124,800	215
220	47.0	468.2	89,700	89,700	49.6	475.5	91,000	105,000	53.3	484.5	77,900	124,400	220
230	44.0	458.0	84,600	84,600	46.8	466.2	83,800	99,300	50.6	476.4	71,200	122,500	230
240	40.9	446.7	79,900	79,900	43.8	456.0	77,100	93,900	47.8	467.5	65,100	116,700	240
250	37.5	434.0	75,600	75,600	40.6	444.6	71,000	88,700	44.9	457.6	59,500	110,900	250
260	33.8	419.6	71,900	71,900	37.1	431.7	65,300	84,000	41.7	446.6	54,300	105,300	260
270	29.6	402.8	67,000	68,800	33.4	417.1	60,000	79,900	38.4	434.3	49,500	99,800	270
280	24.9	382.5	61,800	66,500	29.2	400.1	55,100	76,300	34.8	420.4	45,000	94,900	280
290	19.0	356.5	56,800	65,100	24.4	379.5	50,400	73,500	30.8	404.3	40,700	90,300	290
300	10.1	315.2	51,800	65,100	18.4	352.7	45,900	71,800	26.3	385.2	36,700	86,400	300
310					8.8	308.3	41,400	71,700	20.8	361.1	32,900	83,400	310
320									13.2	326.3	29,100	82,100	320
330													330
340													340
350													350
360													360
370													370
380													380
390													390



# MLC650 VPC-MAX S-2

ASME B30.5

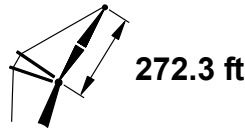
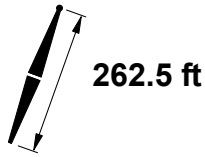
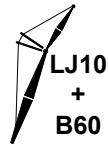

ft	75°				70°			65°			ft
	°	ft	lb	lb	ft	lb	ft	lb	ft		
110											110
115											115
120											120
125											125
130											130
135											135
140											140
145											145
150											150
155											155
160											160
165											165
170											170
175											175
180											180
185											185
190											190
195											195
200	63.9	506.0	69,300	118,800							200
205	62.7	503.4	65,800	118,800							205
210	61.5	500.6	62,500	118,800							210
215	60.3	497.8	59,300	118,800							215
220	59.1	494.7	56,300	118,800							220
230	56.5	488.2	50,600	118,800							230
240	54.0	481.0	45,500	118,800	59.5	488.7	107,700				240
250	51.3	473.1	40,700	114,800	57.0	482.2	101,100				250
260	48.5	464.4	36,300	108,200	54.4	475.2	95,100				260
270	45.6	454.8	32,100	102,100	51.8	467.4	89,400				270
280	42.5	444.1	28,300	96,400	49.0	458.9	84,200	54.7	467.0	72,500	280
290	39.2	432.1	24,700	91,000	46.1	449.4	79,400	52.1	459.3	68,000	290
300	35.7	418.6	21,400	86,100	43.1	438.9	74,800	49.3	450.8	63,900	300
310	31.8	403.1		81,400	39.8	427.2	70,500	46.4	441.5	60,000	310
320	27.4	384.8		77,000	36.3	414.0	66,500	43.4	431.1	56,300	320
330	22.2	362.2		72,900	32.5	398.9	62,800	40.2	419.5	52,900	330
340	15.3	331.0		68,900	28.2	381.2	59,200	36.7	406.5	49,600	340
350					23.2	359.5	55,800	32.9	391.6	46,600	350
360					16.8	330.5	52,500	28.7	374.2	43,600	360
370					3.7	269.4	49,100	23.8	353.1	40,800	370
380								17.6	325.2	38,100	380
390								6.8	274.9	35,300	390

# MLC650 VPC-MAX S-2

ASME B30.5



661,300 lb

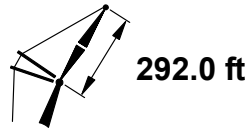
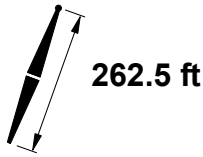

ft	85°				83°				80°				ft
	ft	lb	lb	lb	ft	lb	lb	lb	ft	lb	lb	lb	
115	74.2	551.7	112,500	112,500									115
120	73.2	550.1	112,300	112,300									120
125	72.1	548.5	111,800	111,800									125
130	71.1	546.7	111,200	111,200	73.0	548.8	111,300	111,300					130
135	70.0	544.9	110,900	110,900	71.9	547.1	111,300	111,300					135
140	69.0	542.9	110,300	110,300	70.9	545.4	111,200	111,200					140
145	67.9	540.9	109,700	109,700	69.9	543.5	111,000	111,000					145
150	66.9	538.7	109,100	109,100	68.8	541.5	110,800	110,800					150
155	65.8	536.4	108,500	108,500	67.7	539.4	110,500	110,500					155
160	64.7	534.0	107,800	107,800	66.7	537.2	110,100	110,100	69.6	540.7	108,400	108,400	160
165	63.6	531.5	107,100	107,100	65.6	534.9	109,700	109,700	68.5	538.7	108,400	108,400	165
170	62.5	528.9	106,300	106,300	64.5	532.5	109,300	109,300	67.4	536.6	108,400	108,400	170
175	61.4	526.1	105,600	105,600	63.4	530.0	108,800	108,800	66.4	534.4	108,400	108,400	175
180	60.2	523.2	104,000	104,000	62.3	527.3	108,300	108,300	65.3	532.1	107,600	108,400	180
185	59.1	520.2	101,500	101,500	61.2	524.5	107,800	107,800	64.2	529.6	102,600	108,400	185
190	57.9	517.0	98,900	98,900	60.0	521.6	107,200	107,200	63.1	527.0	97,800	108,400	190
195	56.7	513.7	96,400	96,400	58.9	518.5	106,700	106,700	62.0	524.3	93,300	108,400	195
200	55.5	510.2	93,900	93,900	57.7	515.3	103,800	106,100	60.8	521.5	89,000	108,400	200
205	54.3	506.6	91,400	91,400	56.5	512.0	99,300	105,500	59.7	518.5	84,900	108,200	205
210	53.1	502.8	88,900	88,900	55.3	508.5	95,100	102,900	58.5	515.5	81,100	107,900	210
215	51.8	498.8	86,500	86,500	54.1	504.9	91,100	100,400	57.4	512.2	77,400	107,700	215
220	50.6	494.7	84,100	84,100	52.9	501.0	87,200	98,000	56.2	508.8	73,800	107,400	220
230	47.9	485.8	79,500	79,500	50.3	492.9	80,000	93,100	53.8	501.6	67,200	106,700	230
240	45.2	476.0	75,100	75,100	47.7	483.9	73,400	88,300	51.3	493.7	61,200	106,000	240
250	42.3	465.3	71,000	71,000	45.0	474.1	67,300	83,700	48.7	485.0	55,600	103,700	250
260	39.3	453.3	67,300	67,300	42.1	463.2	61,700	79,300	46.0	475.5	50,500	99,000	260
270	36.0	439.9	63,700	63,900	39.0	451.1	56,400	75,200	43.1	465.0	45,700	94,300	270
280	32.4	424.7	58,500	60,900	35.7	437.6	51,600	71,500	40.1	453.4	41,200	89,800	280
290	28.4	407.1	53,600	58,500	32.1	422.2	47,000	68,100	36.9	440.5	37,100	85,400	290
300	23.8	385.9	49,100	56,700	28.1	404.3	42,700	65,300	33.4	425.8	33,200	81,400	300
310	18.1	358.6	44,700	55,800	23.4	382.7	38,600	63,100	29.6	408.9	29,500	77,800	310
320	9.3	314.7	40,300	55,800	17.5	354.6	34,700	61,900	25.2	388.8	25,900	74,600	320
330					8.0	307.2	30,700	61,200	19.8	363.6	22,600	72,300	330
340									12.4	326.9		71,400	340
350													350
360													360
370													370
380													380
390													390
400													400
410													410

# MLC650 VPC-MAX S-2

ASME B30.5

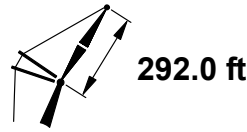
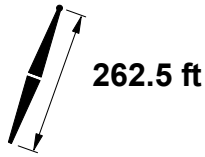

ft	75°				70°			65°			ft
	ft	lb	lb	lb	ft	lb	lb	ft	lb	lb	
115											115
120											120
125											125
130											130
135											135
140											140
145											145
150											150
155											155
160											160
165											165
170											170
175											175
180											180
185											185
190											190
195											195
200											200
205	64.7	525.5	61,300	101,200							205
210	63.6	523.0	58,000	101,200							210
215	62.5	520.4	54,900	101,200							215
220	61.4	517.6	51,900	101,200							220
230	59.1	511.7	46,300	101,200							230
240	56.7	505.2	41,200	101,200							240
250	54.3	498.1	36,400	101,200	59.5	505.6	93,200				250
260	51.9	490.4	32,100	101,200	57.2	499.2	91,600				260
270	49.3	481.9	28,000	98,800	54.8	492.3	86,000				270
280	46.6	472.6	24,200	93,100	52.3	484.6	80,800				280
290	43.8	462.3	20,700	87,900	49.8	476.3	76,000				290
300	40.8	451.0		83,000	47.1	467.2	71,500	52.6	476.5	60,300	300
310	37.7	438.4		78,400	44.3	457.1	67,300	50.0	468.2	56,500	310
320	34.3	424.2		74,000	41.4	446.0	63,300	47.4	459.2	52,900	320
330	30.5	407.8		69,900	38.3	433.6	59,600	44.6	449.2	49,500	330
340	26.3	388.6		66,100	34.9	419.7	56,100	41.7	438.2	46,300	340
350	21.2	364.9		62,400	31.2	403.8	52,700	38.6	426.0	43,300	350
360	14.5	332.2		58,900	27.1	385.2	49,600	35.3	412.3	40,400	360
370					22.2	362.5	46,500	31.6	396.6	37,700	370
380					15.9	332.0	43,600	27.6	378.4	35,100	380
390								22.8	356.2	32,600	390
400								16.7	327.0	30,100	400
410								5.8	272.5	27,600	410

# MLC650 VPC-MAX S-2

ASME B30.5



661,300 lb

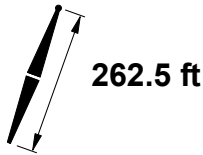

262.5 ft

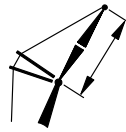

311.7 ft

ft	85°				83°				80°				ft
	ft	lb	lb	lb	ft	lb	lb	lb	ft	lb	lb	lb	
120	74.3	570.7	98,500	98,500									120
125	73.3	569.2	98,300	98,300									125
130	72.3	567.6	97,900	97,900									130
135	71.4	565.9	97,600	97,600									135
140	70.4	564.0	96,900	96,900	72.2	566.2	97,300	97,300					140
145	69.4	562.1	96,500	96,500	71.2	564.5	97,200	97,200					145
150	68.4	560.1	95,900	95,900	70.2	562.6	96,900	96,900					150
155	67.4	558.0	95,400	95,400	69.2	560.7	96,600	96,600					155
160	66.4	555.8	94,900	94,900	68.2	558.7	96,400	96,400					160
165	65.4	553.5	94,300	94,300	67.2	556.5	96,100	96,100	69.9	559.9	94,400	94,400	165
170	64.4	551.0	93,700	93,700	66.2	554.3	95,700	95,700	68.9	557.9	94,400	94,400	170
175	63.3	548.5	93,100	93,100	65.2	552.0	95,400	95,400	67.9	555.9	94,400	94,400	175
180	62.3	545.8	92,500	92,500	64.2	549.5	95,000	95,000	66.9	553.7	94,400	94,400	180
185	61.2	543.0	91,800	91,800	63.1	546.9	94,600	94,600	65.9	551.5	94,400	94,400	185
190	60.2	540.1	91,100	91,100	62.1	544.3	94,100	94,100	64.9	549.1	94,400	94,400	190
195	59.1	537.1	89,000	89,000	61.0	541.5	93,600	93,600	63.9	546.6	90,800	94,300	195
200	58.0	534.0	86,900	86,900	60.0	538.5	93,100	93,100	62.9	544.0	86,500	94,200	200
205	56.9	530.7	84,800	84,800	58.9	535.5	92,600	92,600	61.8	541.3	82,500	94,100	205
210	55.8	527.2	82,700	82,700	57.8	532.3	92,100	92,100	60.8	538.5	78,600	93,900	210
215	54.7	523.7	80,600	80,600	56.7	529.0	88,900	91,600	59.7	535.5	74,900	93,700	215
220	53.5	519.9	78,500	78,500	55.6	525.5	85,000	90,800	58.6	532.4	71,400	93,500	220
230	51.2	512.0	74,400	74,400	53.3	518.2	77,900	86,700	56.4	525.8	64,900	92,900	230
240	48.7	503.3	70,400	70,400	51.0	510.2	71,300	82,500	54.1	518.7	58,900	92,400	240
250	46.2	493.9	66,600	66,600	48.5	501.5	65,200	78,500	51.8	510.9	53,300	91,700	250
260	43.6	483.6	63,100	63,100	46.0	492.0	59,600	74,500	49.4	502.5	48,200	91,000	260
270	40.8	472.2	59,800	59,800	43.3	481.5	54,500	70,700	46.9	493.3	43,500	88,300	270
280	37.8	459.6	56,700	56,700	40.5	470.1	49,600	67,100	44.3	483.2	39,100	84,300	280
290	34.7	445.6	51,900	54,000	37.6	457.4	45,100	63,800	41.6	472.1	35,000	80,500	290
300	31.2	429.6	47,400	51,700	34.4	443.2	40,900	60,800	38.7	459.9	31,100	76,700	300
310	27.4	411.2	43,200	49,700	30.9	427.1	36,900	58,100	35.6	446.3	27,500	73,100	310
320	22.9	389.0	39,200	48,400	27.0	408.3	33,100	55,800	32.2	430.9	24,000	69,800	320
330	17.3	360.5	35,300	47,800	22.4	385.8	29,500	54,200	28.4	413.2	20,800	66,900	330
340	8.5	313.8	31,400	47,800	16.7	356.4	26,000	53,300	24.2	392.3		64,500	340
350					7.2	305.7	22,400	50,200	19.0	365.9		62,600	350
360									11.6	327.2		59,700	360
370													370
380													380
390													390
400													400
410													410
420													420
430													430

# MLC650 VPC-MAX S-2

ASME B30.5

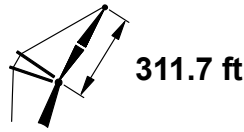
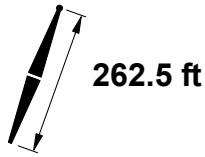

ft	75°				70°			65°			ft
	ft	lb	lb	lb	ft	lb	lb	ft	lb	lb	
120											120
125											125
130											130
135											135
140											140
145											145
150											150
155											155
160											160
165											165
170											170
175											175
180											180
185											185
190											190
195											195
200											200
205											205
210											210
215	64.4	542.5	52,100	87,600							215
220	63.3	540.0	49,100	87,600							220
230	61.2	534.6	43,600	87,600							230
240	59.1	528.6	38,500	87,600							240
250	56.9	522.2	33,800	87,600							250
260	54.7	515.2	29,500	87,600	59.5	522.6	80,100				260
270	52.4	507.6	25,500	87,600	57.3	516.2	80,100				270
280	50.0	499.3	21,700	87,600	55.1	509.3	78,600				280
290	47.5	490.3		85,900	52.8	501.8	73,800				290
300	44.9	480.4		81,000	50.4	493.7	69,300				300
310	42.2	469.6		76,500	48.0	484.8	65,200	53.0	493.6	54,200	310
320	39.4	457.6		72,200	45.4	475.1	61,300	50.7	485.5	50,700	320
330	36.3	444.4		68,100	42.7	464.4	57,600	48.2	476.7	47,300	330
340	33.0	429.5		64,300	39.9	452.7	54,100	45.7	467.1	44,200	340
350	29.4	412.4		60,700	36.9	439.7	50,800	43.0	456.6	41,200	350
360	25.2	392.3		57,300	33.6	425.1	47,700	40.2	445.0	38,400	360
370	20.3	367.5		54,000	30.0	408.5	44,700	37.2	432.2	35,700	370
380	13.7	333.1		50,900	26.0	389.0	41,900	34.0	417.8	33,100	380
390					21.3	365.3	39,200	30.5	401.4	30,700	390
400					15.1	333.4	36,600	26.5	382.3	28,400	400
410								21.9	359.1	26,000	410
420								15.9	328.5	23,400	420
430								4.9	269.2	20,700	430

# MLC650 VPC-MAX S-2

ASME B30.5

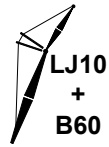

661,300 lb

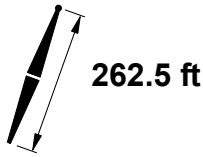

262.5 ft



331.4 ft

ft	85°				83°				80°				ft
	ft	lb	lb	lb	ft	lb	lb	lb	ft	lb	lb	lb	
125	74.3	589.8	83,000	83,000									125
130	73.4	588.3	82,900	82,900									130
135	72.5	586.7	82,500	82,500									135
140	71.6	585.0	82,200	82,200									140
145	70.7	583.2	81,900	81,900	72.3	585.3	82,000	82,000					145
150	69.7	581.3	81,500	81,500	71.4	583.6	81,800	81,800					150
155	68.8	579.3	81,100	81,100	70.5	581.8	81,600	81,600					155
160	67.9	577.3	80,700	80,700	69.6	579.9	81,400	81,400					160
165	66.9	575.1	80,300	80,300	68.7	577.9	81,100	81,100					165
170	66.0	572.9	79,800	79,800	67.7	575.8	80,900	80,900					170
175	65.0	570.5	79,300	79,300	66.8	573.6	80,600	80,600	69.3	577.1	79,100	79,100	175
180	64.1	568.0	78,900	78,900	65.8	571.4	80,300	80,300	68.4	575.1	79,100	79,100	180
185	63.1	565.5	78,300	78,300	64.9	569.0	79,900	79,900	67.5	573.0	79,100	79,100	185
190	62.1	562.8	77,800	77,800	63.9	566.5	79,500	79,500	66.5	570.8	79,000	79,000	190
195	61.1	560.0	77,300	77,300	62.9	563.9	79,200	79,200	65.6	568.5	78,900	78,900	195
200	60.1	557.1	76,800	76,800	61.9	561.2	78,800	78,800	64.6	566.1	78,800	78,800	200
205	59.1	554.1	76,300	76,300	61.0	558.4	78,400	78,400	63.6	563.6	78,500	78,700	205
210	58.1	550.9	75,500	75,500	60.0	555.5	78,000	78,000	62.7	561.0	74,600	78,600	210
215	57.1	547.7	73,800	73,800	58.9	552.5	77,600	77,600	61.7	558.3	71,000	78,400	215
220	56.0	544.3	72,100	72,100	57.9	549.3	77,200	77,200	60.7	555.4	67,500	78,200	220
230	53.9	537.0	68,700	68,700	55.8	542.6	74,200	76,400	58.7	549.4	61,000	77,800	230
240	51.7	529.2	65,300	65,300	53.7	535.3	67,600	75,500	56.6	542.8	55,000	77,400	240
250	49.4	520.8	62,000	62,000	51.5	527.4	61,600	72,500	54.5	535.8	49,500	76,900	250
260	47.1	511.6	58,800	58,800	49.2	518.9	56,000	69,200	52.3	528.1	44,400	76,400	260
270	44.6	501.7	55,800	55,800	46.9	509.7	50,900	66,000	50.1	519.9	39,700	75,800	270
280	42.1	490.8	52,900	52,900	44.4	499.7	46,100	62,800	47.7	510.9	35,300	75,300	280
290	39.4	478.8	48,600	50,200	41.9	488.7	41,600	59,800	45.3	501.2	31,300	74,700	290
300	36.5	465.7	44,100	47,800	39.2	476.7	37,400	56,900	42.8	490.6	27,400	71,500	300
310	33.5	451.0	39,900	45,600	36.3	463.4	33,500	54,100	40.1	478.9	23,800	68,400	310
320	30.1	434.3	36,000	43,700	33.2	448.5	29,800	51,700	37.3	466.1	20,500	65,400	320
330	26.4	415.1	32,300	42,100	29.8	431.7	26,300	49,500	34.3	451.9		62,600	330
340	22.0	392.0	28,700	41,000	26.0	412.2	22,900	47,700	31.1	435.8		59,900	340
350	16.6	362.2	25,300	40,700	21.6	388.6		46,400	27.4	417.4		55,200	350
360	7.8	312.7	21,700	38,100	16.0	357.9		42,600	23.3	395.5		50,500	360
370					6.5	303.7		38,900	18.2	368.0		45,900	370
380									11.0	327.3		41,800	380
390													390
400													400
410													410
420													420

# MLC650 VPC-MAX S-2

ASME B30.5

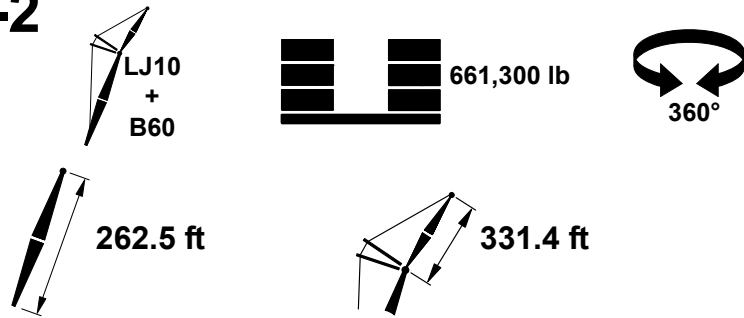

ft	75°			70°			65°			ft
	°	ft	lb	°	ft	lb	°	ft	lb	
125										125
130										130
135										135
140										140
145										145
150										150
155										155
160										160
165										165
170										170
175										175
180										180
185										185
190										190
195										195
200										200
205										205
210										210
215										215
220										220
230	63.1	557.0	73,000							230
240	61.1	551.5	73,000							240
250	59.1	545.6	73,000							250
260	57.1	539.2	73,000							260
270	55.0	532.3	73,000	59.5	539.5	66,300				270
280	52.8	524.7	73,000	57.5	533.2	66,300				280
290	50.6	516.6	73,000	55.4	526.4	66,300				290
300	48.3	507.8	73,000	53.2	519.0	66,100				300
310	45.9	498.3	73,000	51.0	511.0	61,900				310
320	43.4	487.9	69,100	48.7	502.3	58,000	53.4	510.8	47,300	320
330	40.8	476.5	65,100	46.3	492.9	54,400	51.2	502.8	44,000	330
340	38.0	464.0	61,400	43.9	482.7	51,000	49.0	494.2	40,800	340
350	35.1	450.1	57,800	41.3	471.5	47,700	46.6	484.9	37,900	350
360	31.8	434.5	54,400	38.5	459.2	44,600	44.1	474.8	35,100	360
370	28.3	416.7	51,200	35.6	445.6	41,700	41.6	463.7	32,500	370
380	24.3	395.8	48,200	32.4	430.3	38,900	38.8	451.5	29,800	380
390	19.5	369.9	45,200	29.0	412.9	36,300	35.9	438.1	27,000	390
400	13.0	333.9	42,400	25.1	392.7	33,800	32.8	423.0	24,300	400
410				20.5	367.9	31,300	29.4	405.9	21,800	410
420				14.4	334.5	28,900				420

# MLC650 VPC-MAX S-2

ASME B30.5



661,300 lb

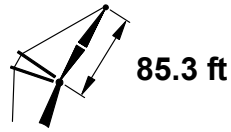
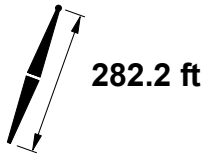

ft	85°				83°				80°				ft
	ft	lb	lb	lb	ft	lb	lb	lb	ft	lb	lb	lb	
60	74.4	372.6	401,700 d	401,700 d									60
65	70.9	370.7	389,700 d	389,700 d									65
70	67.2	368.5	386,000 c	386,000 c									70
75	63.4	365.9	380,900 c	380,900 c	70.7	369.5	393,300 d	393,300 d					75
80	59.5	362.8	375,100 b	375,100 b	67.0	367.2	390,900 c	390,900 c					80
85	55.3	359.2	368,100 b	368,100 b	63.2	364.6	386,700 c	386,700 c					85
90	51.0	355.0	362,100 b	362,100 b	59.3	361.5	367,300 b	381,600 b					90
95	46.3	350.1	345,300	345,300	55.2	357.9	344,300 b	375,600 b	66.7	364.7	316,000 c	394,300 c	95
100	41.1	344.3	330,700	330,700	50.8	353.7	323,600 b	370,100 b	62.9	362.0	297,000 c	391,500 c	100
105	35.3	337.3	319,400	319,400	46.1	348.8	305,000	364,800	59.0	358.9	279,800 b	388,000 b	105
110	28.4	328.2	303,300	311,700	40.9	342.9	288,000	348,900	54.8	355.3	264,200 b	383,800 b	110
115	18.8	314.9	286,400	309,500	35.1	335.8	272,400	336,200	50.4	351.0	250,000 b	379,300 b	115
120					28.0	326.6	257,900	327,300	45.7	346.0	236,900	365,800	120
125					18.3	313.0	244,300	323,900	40.5	340.1	224,900	348,500	125
130									34.6	332.8	213,600	332,600	130
135									27.4	323.4	203,100	317,900	135
140									17.3	309.2	192,900	304,100	140
145													145
150													150
155													155
160													160
165													165
170													170
175													175
180													180
185													185
190													190
195													195
200													200
205													205
210													210



# MLC650 VPC-MAX S-2

ASME B30.5

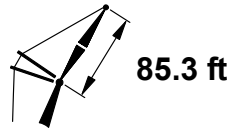
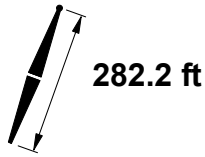
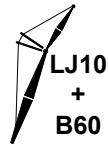

ft	75°				70°				65°				ft
	ft	°	ft	lb	ft	°	ft	lb	ft	°	ft	lb	
60													60
65													65
70													70
75													75
80													80
85													85
90													90
95													95
100													100
105													105
110													110
115													115
120													120
125	62.2	355.8	190,700 b	322,400 b									125
130	58.2	352.6	181,200 b	307,700 b									130
135	54.0	348.9	172,400 b	294,100 b									135
140	49.5	344.5	164,200 b	281,600 b									140
145	44.7	339.3	156,400	269,900									145
150	39.4	333.2	149,200	259,000									150
155	33.3	325.6	142,300	248,800	56.9	343.8	116,200 b	228,900 b					155
160	25.8	315.6	135,600	239,200	52.6	339.9	110,800 b	220,100 b					160
165	14.4	299.3	128,900	229,900	48.1	335.3	105,700 b	211,900 b					165
170					43.1	329.8	100,900	204,200					170
175					37.6	323.3	96,300	196,800					175
180					31.1	315.1	91,800	189,800	55.0	332.4	70,300	173,600	180
185					22.9	303.9	87,300	183,100	50.6	328.1	67,000	167,600	185
190					6.0	279.3	82,200	176,300	45.8	323.2	63,700	161,900	190
195									40.6	317.3	60,600	156,500	195
200									34.7	310.1	57,500	151,300	200
205									27.6	300.7	54,400	146,300	205
210									17.7	286.8	51,200	141,300	210

# MLC650 VPC-MAX S-2

ASME B30.5

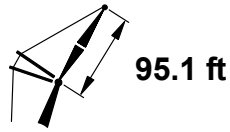
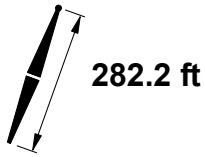

ft	85°				83°				80°				ft
	ft	lb	lb	lb	ft	lb	lb	lb	ft	lb	lb	lb	
65	72.9	381.2	370,500 d	370,500 d									65
70	69.7	379.3	361,400 c	361,400 c									70
75	66.4	377.0	357,500 c	357,500 c	72.8	380.0	365,800 c	365,800 c					75
80	63.0	374.3	352,700 b	352,700 b	69.6	378.0	365,200 c	365,200 c					80
85	59.5	371.3	347,400 b	347,400 b	66.3	375.7	362,700 c	362,700 c					85
90	55.8	367.8	341,000 b	341,000 b	62.8	373.1	358,700 b	358,700 b					90
95	51.9	363.7	335,600	335,600	59.3	370.0	341,600 b	354,100 b	69.3	375.5	312,700 c	366,800 c	95
100	47.8	359.1	322,600	322,600	55.6	366.5	321,100 b	348,700 b	66.0	373.2	293,800 b	366,500 b	100
105	43.4	353.7	309,000	309,000	51.8	362.4	302,600	343,700	62.6	370.5	276,800 b	363,900 b	105
110	38.6	347.4	297,900	297,900	47.7	357.8	285,700	339,200	59.0	367.4	261,300 b	360,800 b	110
115	33.0	339.7	285,600	289,400	43.2	352.4	270,400	327,400	55.3	363.8	247,200 b	357,000 b	115
120	26.4	330.0	270,500	284,100	38.4	346.0	256,200	315,200	51.5	359.7	234,300	353,000	120
125	17.3	315.6	256,200	284,000	32.8	338.3	243,200	305,500	47.3	355.0	222,400	346,100	125
130					26.1	328.4	230,900	299,200	42.9	349.6	211,300	330,400	130
135					16.8	313.7	219,300	297,900	38.0	343.1	201,100	315,800	135
140									32.3	335.2	191,500	302,300	140
145									25.5	325.1	182,400	289,700	145
150									15.8	309.7	173,500	277,800	150
155													155
160													160
165													165
170													170
175													175
180													180
185													185
190													190
195													195
200													200
205													205
210													210
215													215
220													220

# MLC650 VPC-MAX S-2

ASME B30.5

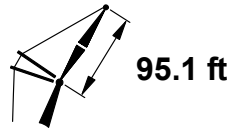
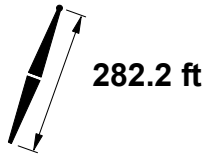

ft	75°				70°				65°				ft
	ft	°	ft	lb	ft	°	ft	lb	ft	°	ft	lb	
65													65
70													70
75													75
80													80
85													85
90													90
95													95
100													100
105													105
110													110
115													115
120													120
125													125
130	61.9	364.3	177,900 b	304,800 b									130
135	58.3	361.1	169,200 b	291,400 b									135
140	54.6	357.4	161,000 b	278,900 b									140
145	50.7	353.2	153,500	267,400									145
150	46.5	348.4	146,400	256,600									150
155	41.9	342.8	139,700	246,500									155
160	36.9	336.1	133,300	237,100	57.2	352.3	107,400	217,400					160
165	31.1	327.9	127,300	228,200	53.4	348.5	102,400	209,200					165
170	24.0	317.1	121,400	219,700	49.4	344.1	97,700	201,600					170
175	12.9	299.4	115,400	211,500	45.1	339.1	93,300	194,400					175
180					40.4	333.1	89,000	187,500					180
185					35.2	326.0	84,900	181,000					185
190					29.1	317.2	80,900	174,800	51.6	336.9	60,300	159,200	190
195					21.2	305.1	76,900	168,900	47.4	332.2	57,300	153,900	195
200									43.0	326.7	54,400	148,800	200
205									38.1	320.3	51,600	144,000	205
210									32.5	312.5	48,800	139,300	210
215									25.8	302.4	46,100	134,800	215
220									16.2	287.3	43,200	130,300	220

# MLC650 VPC-MAX S-2

ASME B30.5



661,300 lb



360°

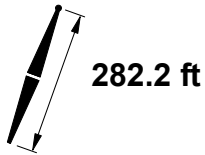

282.2 ft

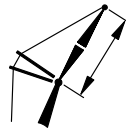

105.0 ft

ft	85°				83°				80°				ft
	ft	lb	lb	lb	ft	lb	lb	lb	ft	lb	lb	lb	
65	74.6	391.6	341,100 d	341,100 d									65
70	71.7	389.9	340,000 c	340,000 c									70
75	68.8	387.8	337,300 c	337,300 c									75
80	65.7	385.5	333,400 b	333,400 b	71.6	388.6	342,900 c	342,900 c					80
85	62.7	382.8	328,500 b	328,500 b	68.6	386.6	341,600 c	341,600 c					85
90	59.5	379.7	323,300 b	323,300 b	65.6	384.2	338,800 b	338,800 b					90
95	56.1	376.3	318,000	318,000	62.5	381.5	335,100 b	335,100 b					95
100	52.7	372.4	314,200	314,200	59.3	378.5	319,800 b	330,600 b	68.4	384.1	292,000 b	343,600 b	100
105	49.0	368.0	302,300	302,300	56.0	375.0	301,300	325,900	65.4	381.7	275,100 b	342,900 b	105
110	45.2	362.9	289,800	289,800	52.5	371.1	284,600	321,300	62.3	379.0	259,700 b	340,600 b	110
115	41.0	357.1	279,300	279,300	48.9	366.6	269,300	317,100	59.1	375.9	245,700 b	337,700 b	115
120	36.4	350.3	270,300	270,700	45.0	361.5	255,400	307,700	55.8	372.4	232,800	334,400	120
125	31.1	342.0	256,600	262,800	40.8	355.7	242,500	296,300	52.3	368.4	221,000	330,800	125
130	24.8	331.6	243,800	257,500	36.2	348.8	230,500	285,900	48.6	363.9	210,100	327,200	130
135	15.9	316.1	231,700	256,800	30.9	340.5	219,400	277,300	44.7	358.8	200,000	314,500	135
140					24.5	329.9	208,900	271,200	40.5	352.8	190,600	301,200	140
145					15.5	314.2	198,900	269,500	35.8	345.9	181,800	288,700	145
150									30.5	337.5	173,400	277,100	150
155									23.9	326.6	165,500	266,200	155
160									14.5	310.1	157,700	255,900	160
165													165
170													170
175													175
180													180
185													185
190													190
195													195
200													200
205													205
210													210
215													215
220													220
230													230

# MLC650 VPC-MAX S-2

ASME B30.5

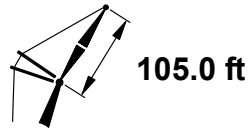
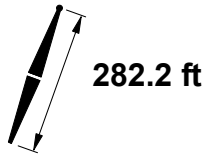
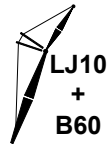

ft	75°				70°				65°				ft
	ft	°	ft	lb	ft	°	ft	lb	ft	°	ft	lb	
65													65
70													70
75													75
80													80
85													85
90													90
95													95
100													100
105													105
110													110
115													115
120													120
125													125
130	64.8	375.6	176,000 b	303,000 b									130
135	61.7	372.8	167,300 b	289,700 b									135
140	58.4	369.6	159,300	277,300									140
145	55.1	366.0	151,800	265,800									145
150	51.6	361.9	144,800	255,100									150
155	47.9	357.3	138,200	245,100									155
160	43.9	352.1	132,000	235,800									160
165	39.6	346.0	126,200	227,000	57.4	360.8	100,500	207,600					165
170	34.8	338.8	120,600	218,700	54.0	357.1	95,900	200,000					170
175	29.3	330.0	115,200	210,900	50.4	352.9	91,600	192,900					175
180	22.4	318.4	110,000	203,400	46.6	348.1	87,400	186,100					180
185	11.6	299.2	104,700	196,200	42.6	342.6	83,500	179,800					185
190					38.2	336.2	79,700	173,700					190
195					33.2	328.5	76,000	167,900	52.4	345.5	55,400	152,400	195
200					27.3	319.1	72,400	162,300	48.7	341.0	52,600	147,400	200
205					19.8	306.1	68,800	157,000	44.8	335.9	49,900	142,600	205
210									40.6	330.0	47,300	138,000	210
215									35.9	323.1	44,800	133,700	215
220									30.6	314.7	42,300	129,400	220
230									14.8	287.7	37,100	121,300	230

# MLC650 VPC-MAX S-2

ASME B30.5

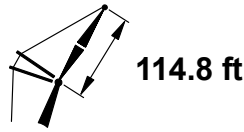
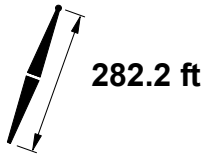
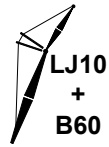

ft	85°				83°				80°				ft
	ft	lb	lb	lb	ft	lb	lb	lb	ft	lb	lb	lb	
70	73.3	400.3	319,200 c	319,200 c									70
75	70.7	398.5	317,500 c	317,500 c									75
80	68.0	396.4	314,500 b	314,500 b									80
85	65.2	394.0	310,800 b	310,800 b	70.6	397.3	320,800 b	320,800 b					85
90	62.4	391.3	306,200 b	306,200 b	67.9	395.1	319,100 b	319,100 b					90
95	59.5	388.2	301,500	301,500	65.1	392.7	316,400 b	316,400 b					95
100	56.4	384.8	296,700	296,700	62.3	390.0	313,000 b	313,000 b					100
105	53.3	381.0	292,100	292,100	59.3	386.9	298,600	309,200	67.7	392.6	271,900 b	321,300 b	105
110	50.0	376.7	280,400	280,400	56.3	383.5	282,000	304,600	64.9	390.2	256,600 b	320,400 b	110
115	46.6	371.9	269,200	269,200	53.2	379.7	266,800	300,500	62.0	387.4	242,600 b	318,600 b	115
120	42.9	366.5	258,900	258,900	49.9	375.4	252,900	296,600	59.1	384.3	229,900	316,100	120
125	38.9	360.2	249,600	249,600	46.4	370.6	240,100	285,400	56.1	380.9	218,100	313,100	125
130	34.5	352.9	241,500	241,500	42.7	365.1	228,300	274,600	52.9	377.0	207,300	309,900	130
135	29.5	344.2	230,600	235,100	38.7	358.8	217,400	264,800	49.6	372.7	197,300	306,600	135
140	23.4	333.0	219,600	231,100	34.3	351.5	207,200	256,100	46.1	367.8	188,000	298,800	140
145	14.8	316.5	209,100	231,100	29.2	342.6	197,600	249,000	42.4	362.3	179,300	286,500	145
150					23.1	331.4	188,500	244,200	38.4	355.9	171,200	275,000	150
155					14.3	314.5	179,700	243,500	33.9	348.5	163,500	264,200	155
160									28.8	339.5	156,200	254,100	160
165									22.5	328.0	149,200	244,600	165
170									13.3	310.3	142,300	235,500	170
175													175
180													180
185													185
190													190
195													195
200													200
205													205
210													210
215													215
220													220
230													230
240													240

# MLC650 VPC-MAX S-2

ASME B30.5

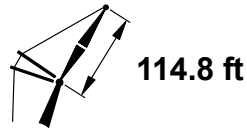
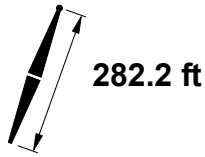
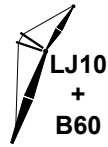

ft	75°				70°				65°				ft
	ft	°	ft	lb	ft	°	ft	lb	ft	°	ft	lb	
70													70
75													75
80													80
85													85
90													90
95													95
100													100
105													105
110													110
115													115
120													120
125													125
130													130
135	64.3	384.0	163,900	286,800									135
140	61.5	381.2	155,900	274,500									140
145	58.5	378.1	148,500	263,100									145
150	55.5	374.6	141,600	252,500									150
155	52.3	370.6	135,100	242,600									155
160	49.0	366.2	129,000	233,300									160
165	45.4	361.2	123,300	224,600									165
170	41.7	355.5	117,800	216,400	57.6	369.3	92,500	197,300					170
175	37.6	348.9	112,700	208,700	54.5	365.7	88,200	190,200					175
180	33.0	341.3	107,700	201,400	51.3	361.6	84,100	183,500					180
185	27.7	331.9	102,900	194,400	47.9	357.0	80,300	177,200					185
190	21.1	319.6	98,300	187,800	44.3	351.8	76,600	171,200					190
195	10.4	298.9	93,400	181,300	40.4	345.9	73,100	165,500					195
200					36.2	339.0	69,700	160,100	53.0	354.1	49,100	144,600	200
205					31.4	330.9	66,400	154,900	49.7	349.8	46,500	139,900	205
210					25.8	320.8	63,100	149,900	46.2	345.0	44,000	135,400	210
215					18.5	307.0	59,900	145,100	42.5	339.4	41,600	131,100	215
220									38.5	333.1	39,300	127,000	220
230									29.0	316.8	34,700	119,300	230
240									13.7	287.9	30,000	111,800	240

# MLC650 VPC-MAX S-2

ASME B30.5



661,300 lb

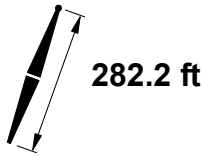

282.2 ft



124.7 ft

ft	85°				83°				80°				ft
	ft	ft	lb	lb	ft	lb	lb	ft	lb	lb			
70	74.7	410.7	306,400 c	306,400 c									70
75	72.3	409.0	300,100 c	300,100 c									75
80	69.8	407.1	298,100 b	298,100 b									80
85	67.3	404.9	295,100 b	295,100 b	72.2	407.8	302,500 b	302,500 b					85
90	64.8	402.5	291,700 b	291,700 b	69.7	405.8	301,700 b	301,700 b					90
95	62.1	399.7	287,300	287,300	67.2	403.7	299,900 b	299,900 b					95
100	59.5	396.7	283,100	283,100	64.7	401.2	297,300 b	297,300 b					100
105	56.7	393.3	278,800	278,800	62.0	398.5	294,200	294,200	69.5	403.3	271,800 b	302,200 b	105
110	53.8	389.6	272,000	272,000	59.4	395.4	282,200	290,400	67.0	401.1	256,600 b	302,200 b	110
115	50.8	385.4	261,200	261,200	56.6	392.0	267,100	286,600	64.5	398.7	242,700	301,600	115
120	47.7	380.8	250,900	250,900	53.7	388.3	253,300	282,900	61.8	395.9	230,000	300,000	120
125	44.4	375.6	241,300	241,300	50.7	384.1	240,600	277,300	59.1	392.8	218,300	297,600	125
130	40.9	369.8	232,500	232,500	47.6	379.5	228,800	266,900	56.4	389.4	207,600	295,000	130
135	37.1	363.2	224,700	224,700	44.3	374.3	218,000	256,900	53.5	385.6	197,600	292,200	135
140	32.8	355.4	217,900	217,900	40.7	368.4	207,900	247,600	50.5	381.4	188,400	289,200	140
145	28.0	346.2	210,800	212,700	36.9	361.7	198,500	239,200	47.3	376.7	179,700	286,400	145
150	22.1	334.4	201,300	209,700	32.6	354.0	189,600	231,900	44.0	371.5	171,700	275,000	150
155	13.7	316.8	192,100	209,700	27.8	344.6	181,300	226,000	40.4	365.6	164,100	264,300	155
160					21.8	332.7	173,300	222,200	36.6	358.8	157,000	254,300	160
165					13.3	314.7	165,500	222,200	32.3	350.9	150,300	244,900	165
170									27.4	341.5	143,800	236,000	170
175									21.3	329.3	137,700	227,700	175
180									12.3	310.3	131,500	219,600	180
185													185
190													190
195													195
200													200
205													205
210													210
215													215
220													220
230													230
240													240
250													250



# MLC650 VPC-MAX S-2

ASME B30.5

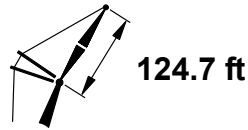
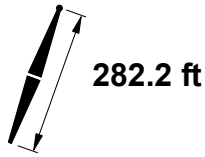

ft	75°				70°				65°				ft
	ft	°	ft	lb	ft	°	ft	lb	ft	°	ft	lb	
70													70
75													75
80													80
85													85
90													90
95													95
100													100
105													105
110													110
115													115
120													120
125													125
130													130
135													135
140	64.0	392.5	155,900	274,200									140
145	61.3	389.7	148,600	262,800									145
150	58.6	386.6	141,700	252,300									150
155	55.8	383.1	135,300	242,400									155
160	52.9	379.2	129,200	233,200									160
165	49.9	374.9	123,500	224,500									165
170	46.7	370.2	118,200	216,400									170
175	43.3	364.8	113,100	208,800	57.7	377.8	88,200	190,000					175
180	39.7	358.7	108,200	201,500	54.9	374.2	84,200	183,400					180
185	35.8	351.8	103,600	194,700	52.0	370.3	80,400	177,100					185
190	31.4	343.6	99,200	188,200	48.9	365.8	76,800	171,200					190
195	26.3	333.7	94,900	182,000	45.7	360.9	73,300	165,500					195
200	19.9	320.7	90,700	176,000	42.2	355.3	70,000	160,200					200
205	9.4	298.3	86,300	170,100	38.5	349.0	66,800	155,100	53.6	362.8	46,600	139,800	205
210					34.5	341.7	63,800	150,200	50.6	358.6	44,100	135,400	210
215					29.9	333.1	60,800	145,500	47.4	353.9	41,800	131,200	215
220					24.5	322.4	57,800	141,000	44.1	348.7	39,500	127,100	220
230									36.7	336.0	35,200	119,500	230
240									27.5	318.8	31,000	112,400	240
250									12.6	288.1	26,600	105,600	250

# MLC650 VPC-MAX S-2

ASME B30.5

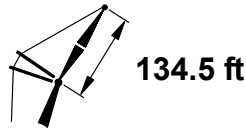
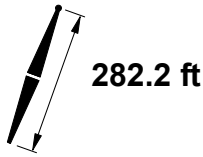

ft	85°				83°				80°				ft
	ft	lb	lb	lb	ft	lb	lb	lb	ft	lb	lb	lb	
75	73.6	419.4	280,500 b	280,500 b									75
80	71.4	417.6	279,300 b	279,300 b									80
85	69.1	415.6	277,300 b	277,300 b									85
90	66.8	413.4	274,600 b	274,600 b	71.3	416.4	281,900 b	281,900 b					90
95	64.4	410.9	271,500	271,500	69.0	414.4	281,000 b	281,000 b					95
100	62.0	408.2	268,100	268,100	66.7	412.2	279,300	279,300					100
105	59.5	405.2	263,900	263,900	64.3	409.7	277,000	277,000					105
110	56.9	401.8	260,100	260,100	61.9	406.9	274,300	274,300	68.8	411.9	253,400	281,800	110
115	54.3	398.2	252,500	252,500	59.4	403.9	264,400	271,300	66.5	409.6	239,600	281,800	115
120	51.5	394.1	242,800	242,800	56.8	400.6	250,700	267,700	64.1	407.1	227,000	281,000	120
125	48.7	389.6	233,400	233,400	54.2	396.9	238,000	264,400	61.7	404.4	215,300	279,600	125
130	45.7	384.7	224,600	224,600	51.4	392.8	226,300	258,500	59.2	401.3	204,600	277,800	130
135	42.5	379.2	216,400	216,400	48.6	388.3	215,600	249,000	56.6	397.9	194,700	275,600	135
140	39.1	373.0	208,900	208,900	45.6	383.3	205,500	239,800	53.9	394.2	185,600	273,200	140
145	35.4	365.9	202,300	202,300	42.4	377.8	196,200	231,200	51.2	390.1	177,000	270,600	145
150	31.4	357.8	196,700	196,700	39.0	371.6	187,500	223,300	48.3	385.6	169,000	268,200	150
155	26.7	348.0	190,900	192,500	35.3	364.5	179,300	216,100	45.3	380.6	161,500	262,000	155
160	21.0	335.6	182,600	190,300	31.2	356.3	171,500	210,000	42.1	375.0	154,500	252,100	160
165	12.8	317.0	174,500	190,300	26.5	346.5	164,200	205,100	38.7	368.7	147,900	242,800	165
170					20.7	333.9	157,200	202,100	35.0	361.6	141,600	234,000	170
175					12.3	314.8	150,200	202,100	30.9	353.3	135,600	225,700	175
180									26.1	343.3	129,900	217,900	180
185									20.2	330.4	124,400	210,500	185
190									11.4	310.2	118,900	203,300	190
195													195
200													200
205													205
210													210
215													215
220													220
230													230
240													240
250													250
260													260

# MLC650 VPC-MAX S-2

ASME B30.5

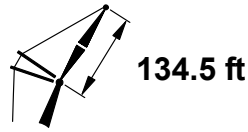
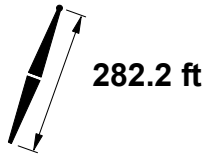

ft	75°				70°				65°				ft
	ft	°	ft	lb	ft	°	ft	lb	ft	°	ft	lb	
75													75
80													80
85													85
90													90
95													95
100													100
105													105
110													110
115													115
120													120
125													125
130													130
135													135
140													140
145	63.6	401.0	145,200	260,100									145
150	61.2	398.2	138,400	249,600									150
155	58.7	395.1	132,100	239,800									155
160	56.1	391.6	126,100	230,600									160
165	53.4	387.8	120,500	222,000									165
170	50.6	383.7	115,200	213,900									170
175	47.7	379.0	110,100	206,300									175
180	44.7	373.9	105,400	199,200	57.9	386.3	80,800	180,700					180
185	41.5	368.2	100,900	192,400	55.3	382.8	77,100	174,500					185
190	38.0	361.8	96,600	186,000	52.6	378.9	73,500	168,600					190
195	34.2	354.4	92,400	179,800	49.8	374.6	70,100	163,000					195
200	30.0	345.8	88,500	174,000	46.8	369.8	66,900	157,700					200
205	25.1	335.4	84,600	168,500	43.7	364.5	63,800	152,600					205
210	18.8	321.7	80,800	163,100	40.4	358.6	60,800	147,800	54.0	371.3	40,700	132,700	210
215	8.3	297.6	76,700	157,800	36.9	351.9	57,900	143,200	51.3	367.2	38,400	128,500	215
220					32.9	344.2	55,200	138,800	48.4	362.7	36,200	124,500	220
230					23.3	323.9	49,800	130,400	42.2	352.2	32,000	117,000	230
240									35.1	338.8	28,100	110,100	240
250									26.2	320.6	24,300	103,600	250
260									11.7	288.0	20,200	97,300	260

# MLC650 VPC-MAX S-2

ASME B30.5



661,300 lb

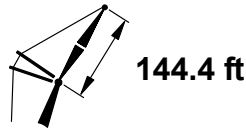
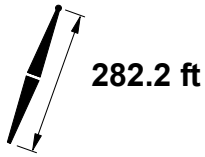

ft	85°				83°				80°				ft
	ft	lb	lb	lb	ft	lb	lb	lb	ft	lb	lb	lb	
75	74.8	429.7	263,800 b	263,800 b									75
80	72.7	428.1	263,300 b	263,300 b									80
85	70.6	426.2	261,900 b	261,900 b									85
90	68.4	424.2	259,800	259,800	72.6	426.9	265,000 b	265,000 b					90
95	66.3	421.9	257,300	257,300	70.5	425.0	264,800	264,800					95
100	64.0	419.4	254,500	254,500	68.4	423.0	263,700	263,700					100
105	61.8	416.7	251,400	251,400	66.2	420.7	262,100	262,100					105
110	59.5	413.7	247,500	247,500	64.0	418.2	260,000	260,000					110
115	57.1	410.3	244,000	244,000	61.7	415.4	257,500	257,500	68.2	420.5	237,500	264,700	115
120	54.6	406.7	234,900	234,900	59.4	412.4	248,800	254,500	66.0	418.2	224,900	264,700	120
125	52.1	402.8	226,000	226,000	57.0	409.1	236,200	251,600	63.8	415.6	213,300	264,000	125
130	49.5	398.4	217,500	217,500	54.5	405.4	224,600	248,600	61.5	412.8	202,700	262,700	130
135	46.7	393.7	209,400	209,400	52.0	401.5	213,900	241,400	59.2	409.8	192,800	261,100	135
140	43.9	388.4	201,800	201,800	49.4	397.1	203,900	232,700	56.8	406.4	183,700	259,100	140
145	40.8	382.5	194,800	194,800	46.6	392.3	194,600	224,400	54.3	402.8	175,100	257,100	145
150	37.5	376.0	188,400	188,400	43.7	387.0	185,900	216,400	51.8	398.8	167,200	254,800	150
155	34.0	368.6	182,800	182,800	40.7	381.2	177,800	208,900	49.2	394.4	159,800	252,600	155
160	30.1	360.0	178,200	178,200	37.4	374.6	170,200	202,100	46.4	389.6	152,800	246,100	160
165	25.5	349.8	174,000	174,700	33.8	367.1	163,000	196,000	43.5	384.2	146,200	237,900	165
170	20.0	336.8	166,600	173,100	29.9	358.5	156,100	190,700	40.4	378.3	140,000	230,000	170
175	11.9	317.0	159,400		25.3	348.2	149,600	186,700	37.1	371.7	134,200	222,600	175
180					19.7	335.0	143,400	184,400	33.6	364.2	128,600	215,900	180
185					11.4	314.7	137,100	184,400	29.6	355.4	123,300	209,200	185
190									25.0	345.0	118,200	202,200	190
195									19.2	331.5	113,200	195,600	195
200									10.5	310.0	108,200	189,100	200
205													205
210													210
215													215
220													220
230													230
240													240
250													250
260													260
270													270

# MLC650 VPC-MAX S-2

ASME B30.5

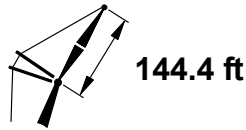
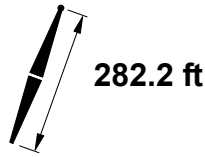

ft	75°				70°				65°			ft
	ft	lb	lb	lb	ft	lb	lb	lb	ft	lb		
75												75
80												80
85												85
90												90
95												95
100												100
105												105
110												110
115												115
120												120
125												125
130												130
135												135
140												140
145												145
150	63.3	409.5	136,300	247,700								150
155	61.1	406.7	129,900	237,900								155
160	58.7	403.5	124,000	228,800								160
165	56.3	400.1	118,400	220,300								165
170	53.9	396.4	113,100	212,200								170
175	51.3	392.3	108,200	204,700								175
180	48.6	387.9	103,500	197,500								180
185	45.9	383.0	99,000	190,800	58.0	394.8	74,900	172,700				185
190	42.9	377.5	94,800	184,400	55.6	391.3	71,400	166,800				190
195	39.8	371.5	90,700	178,300	53.1	387.5	68,000	161,300				195
200	36.5	364.7	86,800	172,600	50.5	383.3	64,800	156,000				200
205	32.8	357.0	83,100	167,100	47.8	378.7	61,800	151,000				205
210	28.7	347.9	79,500	161,800	45.0	373.6	58,900	146,200				210
215	23.9	337.0	76,000	156,800	42.0	368.0	56,000	141,600	54.4	379.9	126,700	215
220	17.9	322.6	72,600	152,000	38.8	361.8	53,300	137,300	51.9	375.9	122,800	220
230					31.6	346.6	48,200	129,100	46.5	366.7	115,300	230
240					22.2	325.3	43,300	121,500	40.5	355.5	108,500	240
250									33.7	341.4	102,200	250
260									25.1	322.3	96,200	260
270									10.8	287.9	90,400	270

# MLC650 VPC-MAX S-2

ASME B30.5



661,300 lb

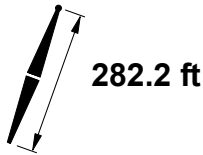

282.2 ft

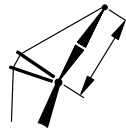

154.2 ft

ft	85°				83°				80°				ft
	ft	lb	lb	lb	ft	lb	lb	lb	ft	lb	lb	lb	
80	73.8	438.4	247,600 b	247,600 b									80
85	71.9	436.7	246,800	246,800									85
90	69.9	434.9	245,400	245,400									90
95	67.9	432.8	243,400	243,400	71.8	435.5	248,800	248,800					95
100	65.8	430.4	241,100	241,100	69.8	433.6	248,400	248,400					100
105	63.8	427.9	238,500	238,500	67.8	431.5	247,300	247,300					105
110	61.6	425.1	235,700	235,700	65.8	429.2	245,800	245,800					110
115	59.5	422.1	232,200	232,200	63.7	426.7	243,800	243,800	69.7	431.1	234,400	247,800	115
120	57.2	418.8	226,900	226,900	61.5	423.9	241,700	241,700	67.6	429.0	221,800	247,800	120
125	55.0	415.3	218,600	218,600	59.4	420.9	233,600	239,300	65.6	426.7	210,300	247,800	125
130	52.6	411.4	210,500	210,500	57.2	417.6	222,000	236,300	63.5	424.1	199,700	247,700	130
135	50.2	407.2	202,700	202,700	54.9	414.0	211,300	233,700	61.4	421.3	189,900	246,600	135
140	47.6	402.5	195,300	195,300	52.5	410.1	201,400	225,500	59.2	418.3	180,800	245,200	140
145	45.0	397.5	188,300	188,300	50.1	405.8	192,100	217,600	57.0	414.9	172,300	243,600	145
150	42.2	391.9	181,700	181,700	47.5	401.2	183,500	209,900	54.7	411.3	164,400	241,800	150
155	39.3	385.8	175,700	175,700	44.9	396.1	175,400	202,500	52.3	407.4	157,000	239,800	155
160	36.1	378.9	170,300	170,300	42.1	390.5	167,900	195,600	49.9	403.1	150,100	237,800	160
165	32.7	371.1	165,600	165,600	39.2	384.4	160,700	189,100	47.3	398.5	143,600	231,200	165
170	28.9	362.2	161,700	161,700	36.0	377.5	154,000	183,200	44.7	393.4	137,500	223,600	170
175	24.5	351.4	158,100	158,900	32.6	369.7	147,600	178,000	41.9	387.7	131,700	216,300	175
180	19.1	337.8	151,600	157,800	28.7	360.6	141,500	173,600	38.9	381.5	126,200	209,300	180
185	11.1	316.9	145,100	157,800	24.3	349.8	135,700	170,300	35.7	374.5	120,900	202,900	185
190					18.8	336.0	130,100	168,500	32.3	366.6	116,000	197,000	190
195					10.6	314.5	124,500	168,500	28.4	357.5	111,200	191,900	195
200									23.9	346.5	106,600	187,500	200
205									18.4	332.4	102,100	181,500	205
210									9.7	309.6	97,500	175,600	210
215													215
220													220
230													230
240													240
250													250
260													260
270													270
280													280

# MLC650 VPC-MAX S-2

ASME B30.5

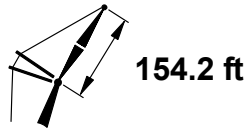
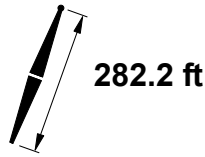
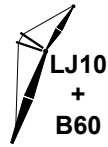

ft	75°				70°				65°				ft
	ft	°	ft	lb	ft	°	ft	lb	ft	°	ft	lb	
80													80
85													85
90													90
95													95
100													100
105													105
110													110
115													115
120													120
125													125
130													130
135													135
140													140
145													145
150													150
155	63.1	418.0	126,700	235,300									155
160	61.0	415.1	120,800	226,200									160
165	58.8	412.0	115,200	217,700									165
170	56.5	408.7	110,000	209,700									170
175	54.2	405.0	105,100	202,200									175
180	51.9	401.0	100,500	195,100									180
185	49.4	396.6	96,000	188,400									185
190	46.8	391.9	91,900	182,100	58.1	403.3	68,000	164,200					190
195	44.1	386.7	87,900	176,000	55.8	399.9	64,700	158,700					195
200	41.3	381.0	84,100	170,300	53.5	396.1	61,600	153,400					200
205	38.3	374.6	80,400	164,900	51.1	392.0	58,600	148,500					205
210	35.1	367.5	76,900	159,700	48.6	387.5	55,700	143,700					210
215	31.5	359.4	73,600	154,800	46.0	382.6	53,000	139,200					215
220	27.6	349.9	70,300	150,000	43.3	377.3	50,300	134,900	54.8	388.5	120,100		220
230	17.0	323.4	64,000	141,000	37.3	364.8	45,300	126,800	50.0	380.3	112,800		230
240					30.4	348.9	40,700	119,300	44.8	370.5	106,000		240
250					21.3	326.6	36,100	112,400	39.0	358.7	99,800		250
260									32.4	343.9	93,900		260
270									24.1	323.9	88,500		270
280									10.0	287.5	83,100		280

# MLC650 VPC-MAX S-2

ASME B30.5



661,300 lb



360°

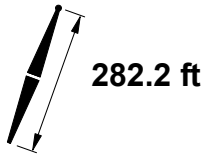

282.2 ft



164.0 ft

ft	85°				83°				80°				ft
	ft	lb	lb	lb	ft	lb	lb	lb	ft	lb	lb	lb	
80	74.8	448.8	233,300 b	233,300 b									80
85	73.0	447.2	233,000	233,000									85
90	71.2	445.4	232,000	232,000									90
95	69.3	443.4	230,500	230,500	72.9	446.0	234,100	234,100					95
100	67.4	441.3	228,700	228,700	71.1	444.2	234,100	234,100					100
105	65.5	439.0	226,500	226,500	69.2	442.2	233,600	233,600					105
110	63.5	436.4	224,100	224,100	67.3	440.1	232,500	232,500					110
115	61.5	433.6	221,100	221,100	65.4	437.7	231,100	231,100					115
120	59.5	430.6	218,300	218,300	63.4	435.2	229,300	229,300	69.1	439.7	220,900	233,100	120
125	57.4	427.3	211,900	211,900	61.4	432.4	227,400	227,400	67.2	437.5	209,400	233,100	125
130	55.2	423.8	204,400	204,400	59.4	429.3	221,300	225,300	65.2	435.2	198,800	233,100	130
135	53.0	420.0	197,000	197,000	57.3	426.1	210,600	222,600	63.3	432.6	189,000	232,900	135
140	50.8	415.8	189,800	189,800	55.2	422.5	200,700	219,000	61.3	429.8	179,900	232,000	140
145	48.4	411.4	183,000	183,000	53.0	418.7	191,500	211,500	59.2	426.7	171,500	230,800	145
150	46.0	406.5	176,500	176,500	50.7	414.5	183,000	204,300	57.1	423.5	163,700	229,300	150
155	43.4	401.1	170,300	170,300	48.3	410.0	174,900	197,100	55.0	419.9	156,300	227,700	155
160	40.8	395.3	164,600	164,600	45.9	405.1	167,400	190,300	52.8	416.0	149,400	226,100	160
165	37.9	388.8	159,400	159,400	43.3	399.8	160,300	183,800	50.5	411.8	142,900	224,300	165
170	34.8	381.7	154,700	154,700	40.6	393.9	153,600	177,700	48.2	407.3	136,800	217,900	170
175	31.5	373.5	150,600	150,600	37.8	387.4	147,300	172,100	45.7	402.4	131,100	210,900	175
180	27.8	364.2	147,300	147,300	34.7	380.2	141,300	166,900	43.1	397.0	125,600	204,100	180
185	23.5	353.0	145,100	145,100	31.4	372.0	135,600	162,300	40.4	391.1	120,500	197,500	185
190	18.3	338.8	139,800	144,300	27.7	362.6	130,200	158,600	37.6	384.5	115,500	191,400	190
195	10.4	316.7	133,900	144,300	23.3	351.4	125,000	155,800	34.5	377.3	110,900	185,700	195
200					18.0	337.0	119,900	154,400	31.1	369.0	106,400	180,500	200
205					9.9	314.2	114,800	154,400	27.3	359.5	102,100	176,000	205
210									23.0	348.0	97,900	172,400	210
215									17.5	333.3	93,800	170,100	215
220									8.9	309.1	89,600	164,800	220
230													230
240													240
250													250
260													260
270													270
280													280
290													290



# MLC650 VPC-MAX S-2

ASME B30.5

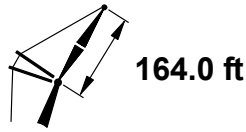
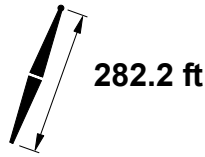
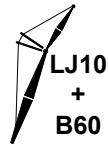

ft	75°				70°				65°				ft
	ft	ft	lb	lb	ft	ft	lb	lb	ft	ft	lb	lb	
80													80
85													85
90													90
95													95
100													100
105													105
110													110
115													115
120													120
125													125
130													130
135													135
140													140
145													145
150													150
155	64.9	429.1	125,600	226,200									155
160	62.9	426.4	119,800	225,200									160
165	60.9	423.6	114,300	216,800									165
170	58.8	420.5	109,100	208,800									170
175	56.7	417.2	104,200	201,300									175
180	54.6	413.5	99,600	194,300									180
185	52.3	409.6	95,200	187,600									185
190	50.1	405.4	91,100	181,300									190
195	47.7	400.8	87,100	175,300	58.2	411.8	63,700	157,700					195
200	45.2	395.7	83,300	169,600	56.0	408.4	60,600	152,500					200
205	42.6	390.3	79,800	164,200	53.9	404.7	57,600	147,600					205
210	39.9	384.2	76,300	159,100	51.6	400.6	54,800	142,900					210
215	37.0	377.6	73,000	154,200	49.3	396.3	52,100	138,400					215
220	33.8	370.1	69,900	149,500	46.9	391.6	49,500	134,100					220
230	26.5	351.8	63,800	140,700	41.8	380.8	44,600	126,100	52.8	393.1	111,900		230
240	16.2	324.1	58,000	132,400	36.0	367.6	40,000	118,700	48.2	384.4	105,200		240
250					29.2	351.1	35,700	111,900	43.2	374.1	99,000		250
260					20.4	327.8	31,500	105,500	37.6	361.7	93,300		260
270									31.2	346.3	87,900		270
280									23.1	325.4	82,900		280
290									9.3	287.1	77,900		290

# MLC650 VPC-MAX S-2

ASME B30.5



661,300 lb

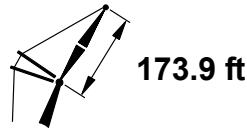
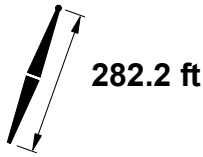

ft	85°				83°				80°				ft
	ft	lb	lb	lb	ft	lb	lb	lb	ft	lb	lb	lb	
85	74.0	457.5	219,200	219,200									85
90	72.3	455.9	218,700	218,700									90
95	70.5	454.0	217,700	217,700									95
100	68.7	452.0	216,200	216,200	72.2	454.6	220,000	220,000					100
105	67.0	449.8	214,500	214,500	70.5	452.8	219,900	219,900					105
110	65.1	447.5	212,500	212,500	68.7	450.8	219,300	219,300					110
115	63.3	444.9	210,400	210,400	66.9	448.6	218,300	218,300					115
120	61.4	442.1	208,000	208,000	65.1	446.2	217,000	217,000					120
125	59.5	439.1	204,500	204,500	63.2	443.6	215,400	215,400	68.5	448.3	206,300	218,900	125
130	57.5	435.8	197,600	197,600	61.3	440.8	213,700	213,700	66.7	446.1	195,800	218,900	130
135	55.5	432.3	190,700	190,700	59.4	437.8	208,000	211,800	64.9	443.7	186,000	218,900	135
140	53.4	428.6	184,000	184,000	57.4	434.6	198,200	209,300	63.1	441.1	177,000	218,700	140
145	51.3	424.5	177,400	177,400	55.4	431.1	189,000	204,900	61.2	438.3	168,600	218,000	145
150	49.1	420.1	171,200	171,200	53.3	427.3	180,400	198,100	59.2	435.2	160,800	216,900	150
155	46.8	415.4	165,200	165,200	51.2	423.2	172,400	191,500	57.3	432.0	153,500	215,700	155
160	44.5	410.2	159,500	159,500	49.0	418.8	164,900	185,000	55.3	428.4	146,600	214,300	160
165	42.0	404.7	154,200	154,200	46.8	414.0	157,900	178,700	53.2	424.6	140,200	212,900	165
170	39.4	398.5	149,200	149,200	44.4	408.9	151,300	172,700	51.1	420.5	134,100	211,400	170
175	36.6	391.8	144,800	144,800	41.9	403.3	145,000	166,900	48.9	416.1	128,400	205,100	175
180	33.7	384.3	140,700	140,700	39.3	397.1	139,100	161,700	46.6	411.3	123,000	198,700	180
185	30.4	375.8	137,300	137,300	36.5	390.4	133,400	156,700	44.2	406.1	117,900	192,400	185
190	26.8	366.1	134,500	134,500	33.6	382.8	128,100	152,200	41.7	400.5	113,000	186,300	190
195	22.7	354.5	132,600	132,700	30.3	374.3	123,000	148,400	39.1	394.3	108,400	180,600	195
200	17.5	339.6	127,300	132,300	26.7	364.5	118,100	145,100	36.3	387.5	104,000	175,100	200
205	9.6	316.3	122,000	132,300	22.5	352.8	113,400	142,800	33.3	379.9	99,800	170,100	205
210					17.3	337.8	108,800	141,900	30.0	371.3	95,700	165,600	210
215					9.2	313.8	104,100	141,900	26.4	361.4	91,800	161,700	215
220									22.1	349.4	88,000	158,700	220
230									8.2	308.4	80,400	153,400	230
240													240
250													250
260													260
270													270
280													280
290													290
300													300

# MLC650 VPC-MAX S-2

ASME B30.5

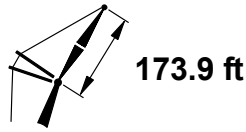
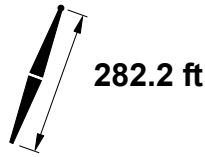

ft	75°				70°				65°			ft
	ft	lb	lb	lb	ft	lb	lb	lb	ft	lb		
85												85
90												90
95												95
100												100
105												105
110												110
115												115
120												120
125												125
130												130
135												135
140												140
145												145
150												150
155												155
160	64.5	437.6	116,500	211,900								160
165	62.7	434.9	111,100	211,900								165
170	60.8	432.1	105,900	206,300								170
175	58.9	429.0	101,100	198,800								175
180	56.9	425.7	96,500	191,800								180
185	54.9	422.1	92,200	185,200								185
190	52.8	418.2	88,100	178,900								190
195	50.6	414.1	84,200	172,900								195
200	48.4	409.6	80,400	167,300	58.2	420.3	57,200	150,000				200
205	46.1	404.7	76,900	161,900	56.3	416.9	54,300	145,000				205
210	43.7	399.4	73,500	156,800	54.2	413.2	51,500	140,400				210
215	41.2	393.7	70,300	152,000	52.1	409.3	48,900	135,900				215
220	38.6	387.4	67,200	147,300	49.9	405.0	46,300	131,700				220
230	32.7	372.7	61,300	138,600	45.4	395.4	41,500	123,700				230
240	25.6	353.6	55,800	130,500	40.4	384.1	37,100	116,400	51.1	397.6	102,600	240
250	15.5	324.7	50,400	123,000	34.8	370.4	32,900	109,700	46.6	388.5	96,500	250
260					28.2	353.1	29,000	103,400	41.8	377.6	90,900	260
270					19.6	328.9	25,100	97,500	36.4	364.7	85,600	270
280									30.1	348.5	80,700	280
290									22.3	326.8	76,000	290
300									8.5	286.5	71,300	300

# MLC650 VPC-MAX S-2

ASME B30.5

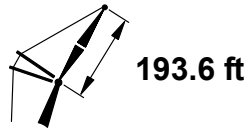
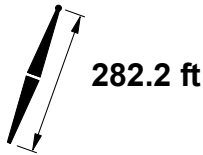

ft	85°				83°				80°				ft
	ft	lb	lb	lb	ft	lb	lb	lb	ft	lb	lb	lb	
90	74.1	476.6	192,600	192,600									90
95	72.6	474.9	192,300	192,300									95
100	71.0	473.2	191,600	191,600									100
105	69.4	471.2	190,700	190,700	72.5	473.7	193,000	193,000					105
110	67.8	469.2	189,500	189,500	71.0	472.0	193,000	193,000					110
115	66.2	466.9	188,100	188,100	69.4	470.0	192,800	192,800					115
120	64.6	464.5	186,500	186,500	67.8	467.9	192,200	192,200					120
125	62.9	461.8	184,900	184,900	66.1	465.7	191,400	191,400					125
130	61.2	459.0	182,700	182,700	64.5	463.2	190,400	190,400	69.2	467.5	191,400	191,400	130
135	59.5	456.0	179,000	179,000	62.8	460.6	189,200	189,200	67.6	465.4	182,100	191,400	135
140	57.7	452.8	173,300	173,300	61.1	457.8	187,900	187,900	66.0	463.1	173,100	191,400	140
145	55.9	449.4	167,700	167,700	59.4	454.8	185,600	186,500	64.4	460.7	164,800	191,400	145
150	54.1	445.7	162,100	162,100	57.6	451.6	177,100	185,000	62.7	458.0	157,000	191,400	150
155	52.2	441.8	156,600	156,600	55.8	448.1	169,200	180,700	61.0	455.2	149,700	191,300	155
160	50.3	437.6	151,400	151,400	54.0	444.4	161,700	175,100	59.3	452.2	143,000	190,600	160
165	48.3	433.1	146,200	146,200	52.1	440.5	154,700	169,700	57.5	448.9	136,600	189,700	165
170	46.2	428.2	141,400	141,400	50.2	436.3	148,200	164,300	55.7	445.5	130,600	188,800	170
175	44.1	423.0	136,700	136,700	48.2	431.7	141,900	159,000	53.9	441.8	124,900	187,800	175
180	41.8	417.4	132,400	132,400	46.1	426.9	136,100	153,800	52.0	437.8	119,600	186,800	180
185	39.5	411.3	128,300	128,300	44.0	421.7	130,500	148,900	50.0	433.6	114,500	183,000	185
190	37.0	404.7	124,600	124,600	41.8	416.0	125,300	144,200	48.0	429.0	109,700	177,600	190
195	34.4	397.4	121,100	121,100	39.4	409.9	120,300	139,700	46.0	424.1	105,100	172,300	195
200	31.6	389.3	118,200	118,200	36.9	403.2	115,500	135,600	43.8	418.9	100,800	167,200	200
205	28.5	380.2	115,600	115,600	34.3	395.9	111,000	131,800	41.6	413.2	96,700	162,200	205
210	25.1	369.7	113,600	113,600	31.5	387.8	106,600	128,400	39.2	407.1	92,700	157,300	210
215	21.1	357.2	111,300	112,400	28.4	378.6	102,400	125,500	36.8	400.3	88,900	152,700	215
220	16.1	341.1	106,900	112,400	25.0	368.1	98,400	123,100	34.1	393.0	85,300	148,400	220
230					15.9	339.2	90,600	121,000	28.2	375.5	78,500	141,000	230
240									20.6	352.0	72,000	135,800	240
250									6.7	306.4	65,500	134,400	250
260													260
270													270
280													280
290													290
300													300
310													310
320													320

# MLC650 VPC-MAX S-2

ASME B30.5

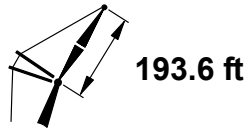
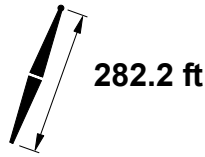
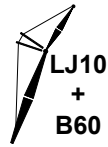

ft	75°				70°				65°				
	ft	lb	lb	lb	ft	lb	lb	lb	ft	lb	lb	ft	
90													90
95													95
100													100
105													105
110													110
115													115
120													120
125													125
130													130
135													135
140													140
145													145
150													150
155													155
160													160
165													165
170	64.0	454.6	101,600	185,100									170
175	62.4	451.9	96,900	185,100									175
180	60.7	449.0	92,300	185,100									180
185	58.9	446.0	88,100	181,800									185
190	57.1	442.7	84,000	175,600									190
195	55.3	439.2	80,200	169,700									195
200	53.5	435.4	76,500	164,100									200
205	51.6	431.4	73,100	158,800									205
210	49.6	427.1	69,700	153,700	58.4	437.3	47,100	136,900					210
215	47.6	422.5	66,600	148,900	56.6	433.9	44,500	132,500					215
220	45.5	417.5	63,500	144,300	54.8	430.3	42,100	128,300					220
230	41.1	406.4	57,800	135,700	51.0	422.4	37,400	120,400					230
240	36.2	393.3	52,500	127,800	47.0	413.3	33,100	113,300					240
250	30.7	377.4	47,600	120,500	42.7	402.8	29,100	106,600	52.0	414.9	93,100		250
260	23.9	356.9	43,000	113,800	38.0	390.4	25,400	100,500	48.1	406.2	87,500		260
270	14.2	325.7	38,400	107,400	32.7	375.6	21,800	94,800	43.9	396.0	82,400		270
280					26.4	357.0		89,500	39.3	384.2	77,600		280
290					18.2	330.9		84,400	34.2	370.2	73,100		290
300									28.2	352.8	68,800		300
310									20.7	329.4	64,800		310
320									7.1	284.8	60,700		320

# MLC650 VPC-MAX S-2

ASME B30.5

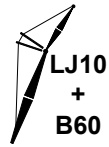

661,300 lb

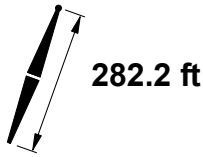

282.2 ft



213.3 ft

ft	85°				83°				80°				ft
	ft	lb	lb	lb	ft	lb	lb	lb	ft	lb	lb	lb	
95	74.2	495.6	170,600	170,600									95
100	72.8	494.0	170,400	170,400									100
105	71.4	492.3	169,900	169,900									105
110	70.0	490.4	169,200	169,200	72.8	492.8	170,800	170,800					110
115	68.5	488.4	168,300	168,300	71.4	491.1	170,800	170,800					115
120	67.1	486.2	167,200	167,200	69.9	489.2	170,800	170,800					120
125	65.6	483.9	166,000	166,000	68.5	487.2	170,400	170,400					125
130	64.1	481.5	164,400	164,400	67.0	485.0	169,900	169,900					130
135	62.6	478.8	162,900	162,900	65.5	482.7	169,100	169,100	69.8	486.7	168,800	168,800	135
140	61.0	476.0	161,300	161,300	64.0	480.2	168,300	168,300	68.4	484.7	168,800	168,800	140
145	59.5	473.0	156,600	156,600	62.5	477.6	167,300	167,300	66.9	482.5	160,900	168,800	145
150	57.9	469.8	151,900	151,900	61.0	474.7	166,200	166,200	65.4	480.2	153,200	168,800	150
155	56.3	466.4	147,100	147,100	59.4	471.7	165,100	165,100	63.9	477.7	146,000	168,800	155
160	54.6	462.8	142,500	142,500	57.8	468.5	158,400	163,500	62.4	475.0	139,200	168,800	160
165	52.9	459.0	137,900	137,900	56.2	465.1	151,500	159,200	60.9	472.2	132,900	168,800	165
170	51.2	454.9	133,500	133,500	54.5	461.5	144,900	154,600	59.3	469.1	126,900	168,600	170
175	49.4	450.6	129,200	129,200	52.8	457.7	138,800	150,000	57.7	465.9	121,300	167,900	175
180	47.6	446.0	125,000	125,000	51.1	453.6	132,900	145,400	56.1	462.5	116,000	167,200	180
185	45.7	441.0	121,100	121,100	49.3	449.3	127,400	141,000	54.4	458.9	111,000	166,500	185
190	43.7	435.8	117,200	117,200	47.5	444.6	122,200	136,700	52.7	455.0	106,200	165,600	190
195	41.7	430.1	113,700	113,700	45.6	439.7	117,300	132,400	51.0	450.9	101,700	162,800	195
200	39.6	424.1	110,300	110,300	43.7	434.4	112,500	128,400	49.2	446.6	97,400	158,300	200
205	37.4	417.5	107,200	107,200	41.6	428.8	108,100	124,400	47.4	441.9	93,400	153,900	205
210	35.0	410.4	104,200	104,200	39.5	422.7	103,800	120,800	45.5	437.0	89,500	149,500	210
215	32.5	402.5	101,700	101,700	37.3	416.1	99,700	117,400	43.5	431.6	85,700	145,200	215
220	29.9	393.9	99,400	99,400	34.9	408.9	95,800	114,100	41.5	425.9	82,200	141,000	220
230	23.6	372.9	96,100	96,100	29.7	392.4	88,400	108,600	37.1	413.2	75,500	133,200	230
240	15.0	342.3	89,400	95,300	23.5	371.3	81,500	104,600	32.2	398.1	69,300	126,100	240
250					14.7	340.4	74,900	103,400	26.5	379.4	63,600	120,300	250
260									19.3	354.3	58,100	116,400	260
270									5.3	303.3	52,400	115,700	270
280													280
290													290
300													300
310													310
320													320
330													330
340													340

# MLC650 VPC-MAX S-2

ASME B30.5

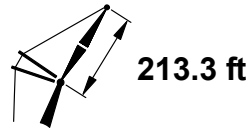
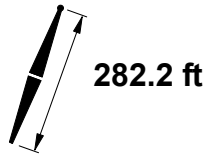

ft	75°				70°			65°			ft
	ft	ft	lb	lb	ft	lb	ft	lb	ft		
95											95
100											100
105											105
110											110
115											115
120											120
125											125
130											130
135											135
140											140
145											145
150											150
155											155
160											160
165											165
170											170
175											175
180	63.6	471.5	88,200	163,200							180
185	62.1	468.8	83,900	163,200							185
190	60.5	466.0	79,900	163,200							190
195	59.0	462.9	76,200	163,200							195
200	57.4	459.7	72,600	160,800							200
205	55.7	456.2	69,100	155,600							205
210	54.1	452.5	65,900	150,600							210
215	52.4	448.6	62,700	145,800							215
220	50.6	444.5	59,700	141,200	58.5	454.2	124,900				220
230	47.0	435.4	54,200	132,700	55.2	447.4	117,100				230
240	43.1	424.9	49,000	124,900	51.8	439.7	110,000				240
250	38.9	412.9	44,200	117,800	48.3	430.9	103,500				250
260	34.3	398.9	39,800	111,100	44.5	421.0	97,400	52.8	432.1	84,100	260
270	29.0	381.8	35,600	104,900	40.4	409.6	91,800	49.2	423.7	79,100	270
280	22.5	359.9	31,600	99,100	35.9	396.3	86,600	45.5	414.1	74,400	280
290	13.1	326.4	27,600	93,600	30.9	380.4	81,700	41.5	403.1	70,000	290
300					24.9	360.6	77,100	37.2	390.4	65,800	300
310					16.9	332.7	72,700	32.3	375.3	61,900	310
320								26.6	356.7	58,200	320
330								19.4	331.7	54,700	330
340								5.8	282.1	51,100	340

# MLC650 VPC-MAX S-2

ASME B30.5

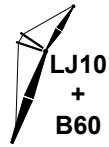

661,300 lb

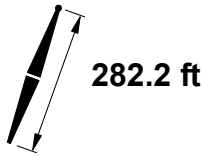

282.2 ft



232.9 ft

ft	85°				83°				80°				ft
	ft	lb	lb	lb	ft	lb	lb	lb	ft	lb	lb	lb	
100	74.3	514.7	151,300	151,300									100
105	73.0	513.1	151,200	151,200									105
110	71.8	511.4	150,800	150,800									110
115	70.4	509.6	150,300	150,300	73.0	511.9	151,000	151,000					115
120	69.1	507.6	149,600	149,600	71.7	510.2	151,000	151,000					120
125	67.8	505.5	148,900	148,900	70.4	508.4	151,000	151,000					125
130	66.4	503.3	148,000	148,000	69.1	506.4	151,000	151,000					130
135	65.1	501.0	147,000	147,000	67.7	504.3	150,600	150,600					135
140	63.7	498.4	145,900	145,900	66.4	502.1	150,100	150,100					140
145	62.3	495.8	144,600	144,600	65.0	499.7	149,600	149,600	69.0	503.9	149,000	149,000	145
150	60.9	492.9	142,000	142,000	63.7	497.2	148,900	148,900	67.6	501.8	149,000	149,000	150
155	59.5	490.0	138,000	138,000	62.3	494.5	148,100	148,100	66.3	499.6	143,300	149,000	155
160	58.0	486.8	134,100	134,100	60.8	491.7	147,200	147,200	64.9	497.2	136,500	149,000	160
165	56.5	483.4	130,100	130,100	59.4	488.7	146,400	146,400	63.5	494.6	130,200	149,000	165
170	55.0	479.9	126,300	126,300	58.0	485.5	142,700	145,300	62.1	492.0	124,300	149,000	170
175	53.5	476.1	122,400	122,400	56.5	482.2	136,500	141,400	60.7	489.1	118,700	149,000	175
180	51.9	472.2	118,700	118,700	55.0	478.6	130,700	137,500	59.3	486.1	113,500	148,900	180
185	50.3	468.0	115,000	115,000	53.4	474.9	125,300	133,600	57.8	482.9	108,500	148,500	185
190	48.7	463.6	111,500	111,500	51.9	470.9	120,100	129,800	56.4	479.5	103,800	148,400	190
195	47.0	458.9	108,000	108,000	50.3	466.7	115,200	126,000	54.8	476.0	99,300	147,400	195
200	45.2	453.9	104,700	104,700	48.6	462.2	110,500	122,300	53.3	472.2	95,100	146,800	200
205	43.4	448.5	101,600	101,600	46.9	457.5	106,000	118,700	51.7	468.2	91,000	145,800	205
210	41.6	442.9	98,600	98,600	45.2	452.5	101,800	115,200	50.1	464.0	87,100	142,000	210
215	39.7	436.8	95,800	95,800	43.4	447.2	97,700	111,800	48.5	459.5	83,500	138,400	215
220	37.6	430.3	93,100	93,100	41.5	441.5	93,900	108,600	46.8	454.8	80,000	134,700	220
230	33.3	415.7	88,400	88,400	37.6	428.9	86,600	102,500	43.2	444.4	73,400	127,400	230
240	28.3	398.2	84,700	84,700	33.2	414.2	79,900	97,300	39.4	432.6	67,300	120,500	240
250	22.3	375.9	81,700	82,200	28.2	396.6	73,700	93,000	35.3	418.9	61,700	114,100	250
260	13.9	343.3	75,300	81,800	22.2	374.3	67,900	89,900	30.6	402.8	56,400	108,500	260
270					13.7	341.3	62,200	89,100	25.1	383.0	51,500	103,900	270
280									18.1	356.3	46,800	100,900	280
290									3.6	298.4	41,700	99,300	290
300													300
310													310
320													320
330													330
340													340
350													350
360													360



# MLC650 VPC-MAX S-2

ASME B30.5

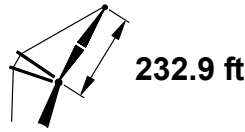
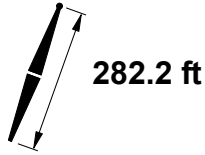

ft	75°				70°			65°			ft
	ft	lb	lb	lb	ft	lb	lb	ft	lb	lb	
100											100
105											105
110											110
115											115
120											120
125											125
130											130
135											135
140											140
145											145
150											150
155											155
160											160
165											165
170											170
175											175
180											180
185	64.7	491.1	80,900	141,700							185
190	63.3	488.5	77,000	141,700							190
195	61.9	485.8	73,200	141,700							195
200	60.5	482.9	69,700	141,700							200
205	59.0	479.9	66,300	141,700							205
210	57.6	476.7	63,100	141,700							210
215	56.1	473.2	60,000	141,700							215
220	54.5	469.6	57,000	139,000							220
230	51.4	461.8	51,500	130,500	58.6	471.2	114,600				230
240	48.1	453.0	46,400	122,800	55.6	464.5	107,600				240
250	44.7	443.1	41,800	115,700	52.5	456.9	101,100				250
260	41.0	431.9	37,400	109,100	49.3	448.5	95,200				260
270	37.0	419.1	33,400	103,100	45.9	439.0	89,600	53.3	449.3	76,600	270
280	32.6	404.1	29,500	97,400	42.3	428.2	84,500	50.2	441.1	72,000	280
290	27.5	386.0	25,900	92,100	38.4	416.0	79,700	46.8	431.9	67,600	290
300	21.2	362.7	22,400	87,100	34.1	401.8	75,200	43.3	421.6	63,600	300
310	12.0	326.7		82,200	29.3	384.9	71,000	39.5	409.8	59,800	310
320					23.6	363.8	66,900	35.3	396.2	56,200	320
330					15.8	334.1	63,100	30.7	380.1	52,800	330
340								25.2	360.3	49,600	340
350								18.2	333.8	46,400	350
360								4.3	278.1	43,200	360

# MLC650 VPC-MAX S-2

ASME B30.5



661,300 lb

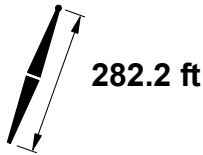

282.2 ft

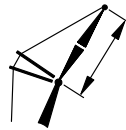

252.6 ft

ft	85°				83°				80°				ft
	ft	lb	lb	lb	ft	lb	lb	lb	ft	lb	lb	lb	
105	74.4	533.7	133,600	133,600									105
110	73.2	532.2	133,500	133,500									110
115	72.0	530.5	133,100	133,100									115
120	70.8	528.7	132,700	132,700									120
125	69.6	526.8	132,300	132,300	72.0	529.3	133,200	133,200					125
130	68.4	524.8	131,600	131,600	70.8	527.5	133,200	133,200					130
135	67.2	522.7	130,800	130,800	69.6	525.6	133,100	133,100					135
140	65.9	520.4	130,000	130,000	68.3	523.6	132,900	132,900					140
145	64.7	518.0	129,000	129,000	67.1	521.4	132,500	132,500					145
150	63.4	515.4	128,000	128,000	65.9	519.1	132,100	132,100	69.5	523.1	130,800	130,800	150
155	62.1	512.7	127,000	127,000	64.6	516.7	131,600	131,600	68.2	521.1	130,800	130,800	155
160	60.8	509.9	124,300	124,300	63.3	514.2	131,000	131,000	67.0	518.9	130,800	130,800	160
165	59.5	506.9	120,900	120,900	62.0	511.5	130,200	130,200	65.8	516.6	126,200	130,800	165
170	58.1	503.8	117,700	117,700	60.7	508.6	129,500	129,500	64.5	514.2	120,300	130,800	170
175	56.8	500.4	114,400	114,400	59.4	505.6	128,600	128,600	63.2	511.6	114,800	130,800	175
180	55.4	497.0	111,100	111,100	58.1	502.5	127,100	127,800	61.9	508.9	109,500	130,800	180
185	54.0	493.3	107,900	107,900	56.7	499.2	121,700	124,600	60.6	506.1	104,600	130,800	185
190	52.5	489.4	104,700	104,700	55.3	495.7	116,500	121,400	59.3	503.1	99,900	130,800	190
195	51.1	485.3	101,600	101,600	53.9	492.0	111,600	118,100	58.0	499.9	95,500	130,600	195
200	49.6	481.0	98,600	98,600	52.5	488.1	107,000	114,900	56.6	496.5	91,200	130,600	200
205	48.1	476.5	95,600	95,600	51.0	484.0	102,600	111,800	55.2	493.0	87,200	129,700	205
210	46.5	471.7	92,800	92,800	49.5	479.7	98,400	108,600	53.8	489.3	83,400	129,600	210
215	44.9	466.7	90,000	90,000	48.0	475.2	94,300	105,600	52.4	485.4	79,800	129,000	215
220	43.2	461.3	87,400	87,400	46.4	470.4	90,500	102,500	50.9	481.3	76,300	126,400	220
230	39.7	449.6	82,600	82,600	43.1	459.9	83,300	96,800	47.9	472.5	69,800	120,300	230
240	35.9	436.2	78,300	78,300	39.6	448.2	76,700	91,500	44.7	462.5	63,800	114,100	240
250	31.7	420.7	74,600	74,600	35.9	434.8	70,600	86,700	41.3	451.4	58,200	108,100	250
260	27.0	402.2	71,800	71,800	31.7	419.2	64,900	82,600	37.6	438.8	53,100	102,600	260
270	21.2	378.7	67,100	70,000	26.9	400.6	59,600	79,200	33.7	424.4	48,300	97,400	270
280	13.0	344.0	61,600	69,800	21.0	377.0	54,600	76,900	29.2	407.3	43,800	93,000	280
290					12.8	341.9	49,700	76,500	23.9	386.4	39,600	89,300	290
300									17.1	358.1	35,500	87,100	300
310													310
320													320
330													330
340													340
350													350
360													360
370													370
380													380

# MLC650 VPC-MAX S-2

ASME B30.5

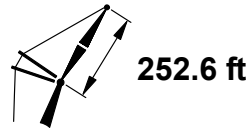
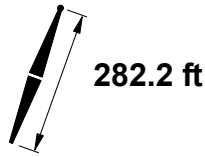
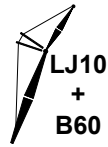

ft	75°				70°				65°			
	ft	ft	lb	lb	ft	ft	lb	ft	ft	lb	ft	
105												105
110												110
115												115
120												120
125												125
130												130
135												135
140												140
145												145
150												150
155												155
160												160
165												165
170												170
175												175
180												180
185												185
190												190
195	64.3	508.1	68,900	124,100								195
200	63.0	505.5	65,300	124,100								200
205	61.7	502.8	62,000	124,100								205
210	60.4	499.9	58,800	124,100								210
215	59.1	496.8	55,800	124,100								215
220	57.7	493.6	52,900	124,100								220
230	54.9	486.7	47,400	124,100								230
240	52.1	479.0	42,400	119,600	58.6	488.2	104,100					240
250	49.1	470.5	37,800	112,600	55.9	481.5	97,700					250
260	46.0	461.1	33,500	106,100	53.1	474.1	91,800					260
270	42.7	450.4	29,600	100,100	50.1	465.9	86,400					270
280	39.1	438.5	25,900	94,400	47.1	456.7	81,300	53.8	466.4	68,500		280
290	35.3	424.8	22,400	89,200	43.8	446.6	76,500	50.9	458.5	64,200		290
300	31.0	408.9		84,300	40.4	435.1	72,100	47.9	449.6	60,200		300
310	26.1	389.8		79,700	36.7	422.1	68,000	44.7	439.7	56,500		310
320	20.1	365.2		75,300	32.6	407.0	64,000	41.3	428.6	53,000		320
330	11.1	326.8		71,100	27.9	389.2	60,300	37.7	416.0	49,700		330
340					22.4	366.8	56,800	33.7	401.6	46,500		340
350					14.9	335.3	53,400	29.2	384.6	43,500		350
360								24.0	363.7	40,700		360
370								17.2	335.6	37,900		370
380								2.1	269.8	34,900		380

# MLC650 VPC-MAX S-2

ASME B30.5



661,300 lb

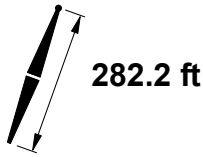

282.2 ft

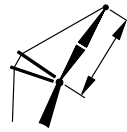

272.3 ft

ft	85°				83°				80°				ft
	ft	lb	lb	lb	ft	lb	lb	lb	ft	lb	lb	lb	
110	74.5	552.8	118,600	118,600									110
115	73.4	551.2	118,500	118,500									115
120	72.3	549.6	118,100	118,100									120
125	71.2	547.8	117,600	117,600									125
130	70.0	546.0	117,200	117,200	72.2	548.4	118,200	118,200					130
135	68.9	544.0	116,600	116,600	71.1	546.6	118,100	118,100					135
140	67.8	541.9	115,900	115,900	70.0	544.8	117,900	117,900					140
145	66.6	539.7	115,200	115,200	68.9	542.8	117,600	117,600					145
150	65.5	537.4	114,400	114,400	67.7	540.7	117,300	117,300					150
155	64.3	535.0	113,500	113,500	66.6	538.5	116,900	116,900	69.9	542.3	115,600	115,600	155
160	63.1	532.4	112,700	112,700	65.4	536.2	116,400	116,400	68.8	540.3	115,600	115,600	160
165	61.9	529.7	111,800	111,800	64.2	533.7	115,900	115,900	67.6	538.2	115,600	115,600	165
170	60.7	526.9	109,100	109,100	63.1	531.2	115,300	115,300	66.5	536.0	115,600	115,600	170
175	59.5	523.9	106,300	106,300	61.9	528.4	114,600	114,600	65.3	533.7	112,000	115,600	175
180	58.2	520.7	103,600	103,600	60.6	525.6	114,000	114,000	64.1	531.2	106,800	115,600	180
185	57.0	517.4	100,800	100,800	59.4	522.6	113,300	113,300	63.0	528.6	101,900	115,600	185
190	55.7	514.0	98,100	98,100	58.2	519.5	112,500	112,500	61.8	525.9	97,300	115,600	190
195	54.4	510.4	95,400	95,400	56.9	516.2	109,400	110,100	60.6	523.0	92,900	115,600	195
200	53.1	506.6	92,700	92,700	55.6	512.7	104,700	107,400	59.3	520.0	88,700	115,500	200
205	51.7	502.6	90,000	90,000	54.3	509.1	100,300	104,700	58.1	516.9	84,700	115,200	205
210	50.4	498.4	87,500	87,500	53.0	505.3	96,200	102,000	56.8	513.6	80,900	114,800	210
215	49.0	494.0	85,000	85,000	51.7	501.3	92,200	99,300	55.5	510.1	77,300	114,400	215
220	47.5	489.4	82,500	82,500	50.3	497.1	88,400	96,700	54.2	506.4	73,800	114,000	220
230	44.6	479.4	77,900	77,900	47.5	488.1	81,300	91,500	51.6	498.6	67,400	112,700	230
240	41.4	468.4	73,700	73,700	44.5	478.1	74,700	86,600	48.8	490.0	61,500	107,500	240
250	38.1	455.9	69,700	69,700	41.3	467.0	68,700	81,900	45.9	480.5	56,000	102,300	250
260	34.4	441.8	66,400	66,400	38.0	454.5	63,100	77,700	42.8	469.9	51,000	97,300	260
270	30.4	425.4	63,500	63,500	34.3	440.4	57,900	73,900	39.6	458.1	46,300	92,400	270
280	25.8	405.9	60,500	61,300	30.3	424.0	53,000	70,600	36.1	444.8	41,900	87,900	280
290	20.2	381.2	55,600	60,100	25.7	404.4	48,500	68,000	32.2	429.5	37,800	83,800	290
300	12.1	344.4	50,700	60,000	20.0	379.5	44,100	66,300	27.9	411.5	33,900	80,200	300
310					11.9	342.3	39,800	66,000	22.8	389.5	30,200	77,300	310
320									16.2	359.7	26,600	75,700	320
330													330
340													340
350													350
360													360
370													370
380													380
390													390

# MLC650 VPC-MAX S-2

ASME B30.5

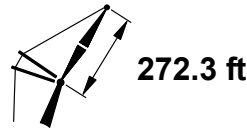
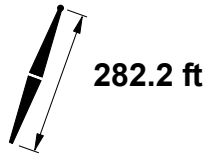
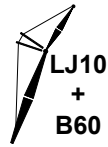

ft	75°				70°				65°				ft
	°	ft	lb	lb	°	ft	lb	lb	°	ft	lb	lb	
110													110
115													115
120													120
125													125
130													130
135													135
140													140
145													145
150													150
155													155
160													160
165													165
170													170
175													175
180													180
185													185
190													190
195													195
200													200
205	63.9	525.1	59,000	109,800									205
210	62.7	522.5	55,900	109,800									210
215	61.5	519.7	52,900	109,800									215
220	60.3	516.8	50,000	109,800									220
230	57.8	510.6	44,600	109,800									230
240	55.3	503.8	39,700	109,800									240
250	52.7	496.2	35,200	109,800	58.7	505.1	95,300						250
260	49.9	488.0	31,000	104,000	56.2	498.5	89,500						260
270	47.1	478.8	27,100	98,000	53.6	491.2	84,100						270
280	44.1	468.7	23,400	92,500	50.9	483.2	79,000						280
290	40.9	457.4	20,000	87,300	48.1	474.4	74,400	54.3	483.6	61,800			290
300	37.5	444.7		82,500	45.1	464.6	70,000	51.6	475.7	57,900			300
310	33.8	430.3		78,000	42.0	453.7	65,900	48.8	467.1	54,200			310
320	29.7	413.5		73,700	38.7	441.6	62,100	45.9	457.6	50,800			320
330	25.0	393.4		69,700	35.1	427.8	58,400	42.9	447.1	47,500			330
340	19.1	367.5		65,800	31.2	411.9	55,000	39.6	435.3	44,400			340
350	10.3	326.7		62,100	26.7	393.1	51,700	36.1	422.0	41,500			350
360					21.3	369.6	48,600	32.3	406.7	38,700			360
370					14.0	336.3	45,600	28.0	388.8	36,100			370
380								22.9	366.9	33,600			380
390								16.3	337.2	31,100			390

# MLC650 VPC-MAX S-2

ASME B30.5



661,300 lb

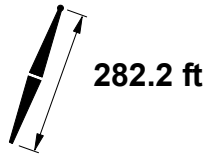

282.2 ft

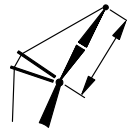

292.0 ft

ft	85°				83°				80°				ft
	ft	lb	lb	lb	ft	lb	lb	lb	ft	lb	lb	lb	
115	74.5	571.8	103,600	103,600									115
120	73.5	570.3	103,500	103,500									120
125	72.5	568.7	103,100	103,100									125
130	71.4	567.0	102,700	102,700									130
135	70.4	565.1	102,200	102,200	72.4	567.5	102,900	102,900					135
140	69.3	563.2	101,700	101,700	71.4	565.7	102,800	102,800					140
145	68.3	561.2	101,100	101,100	70.4	563.9	102,600	102,600					145
150	67.2	559.1	100,500	100,500	69.3	562.0	102,400	102,400					150
155	66.1	556.8	99,900	99,900	68.2	560.0	102,300	102,300					155
160	65.1	554.5	99,200	99,200	67.2	557.8	101,700	101,700					160
165	64.0	552.0	98,500	98,500	66.1	555.6	101,300	101,300	69.2	559.5	100,500	100,500	165
170	62.9	549.4	97,800	97,800	65.0	553.2	100,900	100,900	68.2	557.5	100,500	100,500	170
175	61.7	546.7	97,000	97,000	63.9	550.7	100,400	100,400	67.1	555.3	100,500	100,500	175
180	60.6	543.8	95,200	95,200	62.8	548.1	99,900	99,900	66.0	553.1	100,500	100,500	180
185	59.5	540.8	92,800	92,800	61.7	545.4	99,400	99,400	64.9	550.7	97,700	100,500	185
190	58.3	537.7	90,500	90,500	60.6	542.5	98,800	98,800	63.8	548.2	93,100	100,500	190
195	57.1	534.4	88,200	88,200	59.4	539.6	98,200	98,200	62.7	545.6	88,700	100,400	195
200	56.0	531.0	86,000	86,000	58.3	536.4	97,600	97,600	61.6	542.8	84,500	100,300	200
205	54.7	527.5	83,700	83,700	57.1	533.2	96,500	96,600	60.5	540.0	80,600	100,100	205
210	53.5	523.7	81,400	81,400	55.9	529.7	92,300	94,400	59.3	537.0	76,800	99,800	210
215	52.3	519.8	79,200	79,200	54.7	526.2	88,300	92,200	58.2	533.8	73,200	99,500	215
220	51.0	515.7	77,000	77,000	53.5	522.4	84,500	89,900	57.0	530.5	69,800	99,200	220
230	48.4	507.0	72,800	72,800	51.0	514.4	77,500	85,400	54.6	523.5	63,400	98,500	230
240	45.7	497.4	68,900	68,900	48.4	505.7	71,000	81,100	52.1	515.9	57,500	97,700	240
250	42.8	486.8	65,100	65,100	45.6	496.1	65,000	76,900	49.6	507.5	52,100	95,400	250
260	39.8	475.1	61,700	61,700	42.8	485.4	59,400	72,900	46.9	498.2	47,100	91,100	260
270	36.6	462.0	58,700	58,700	39.7	473.7	54,300	69,200	44.1	488.1	42,400	86,800	270
280	33.1	447.1	55,900	55,900	36.5	460.5	49,500	65,800	41.2	476.9	38,100	82,700	280
290	29.2	429.9	52,400	53,700	33.0	445.6	45,000	62,700	38.0	464.4	34,000	78,800	290
300	24.7	409.5	47,900	52,000	29.1	428.4	40,800	60,100	34.6	450.4	30,200	75,100	300
310	19.2	383.5	43,500	51,100	24.6	407.9	36,800	58,100	30.9	434.4	26,600	71,800	310
320	11.3	344.6	39,300	51,100	19.1	381.8	33,000	56,800	26.7	415.5	23,200	69,000	320
330					11.1	342.4	29,100	56,600	21.8	392.4	20,000	66,700	330
340									15.4	361.1		65,400	340
350													350
360													360
370													370
380													380
390													390
400													400
410													410

# MLC650 VPC-MAX S-2

ASME B30.5

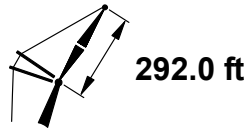
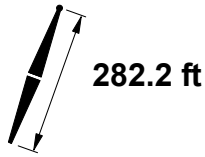
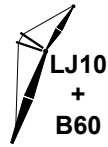

ft	75°				70°			65°			ft
	ft	lb	lb	lb	ft	lb	ft	lb	lb		
115											115
120											120
125											125
130											130
135											135
140											140
145											145
150											150
155											155
160											160
165											165
170											170
175											175
180											180
185											185
190											190
195											195
200											200
205											205
210	64.7	544.6	51,300	94,000							210
215	63.6	542.1	48,300	94,000							215
220	62.5	539.4	45,500	94,000							220
230	60.3	533.8	40,200	94,000							230
240	57.9	527.6	35,300	94,000							240
250	55.6	520.8	30,800	94,000							250
260	53.1	513.4	26,700	94,000	58.7	522.1	85,900				260
270	50.6	505.3	22,800	94,000	56.4	515.5	80,500				270
280	48.0	496.4		89,200	54.0	508.3	75,600				280
290	45.2	486.7		84,100	51.5	500.5	70,900				290
300	42.4	475.9		79,300	48.9	491.9	66,600	54.6	500.6	54,300	300
310	39.3	464.0		74,800	46.2	482.5	62,600	52.2	493.0	50,700	310
320	36.0	450.7		70,600	43.4	472.1	58,800	49.6	484.6	47,300	320
330	32.5	435.5		66,700	40.4	460.6	55,200	46.9	475.4	44,000	330
340	28.5	417.9		62,900	37.2	447.7	51,800	44.1	465.3	41,000	340
350	23.9	396.8		59,300	33.7	433.2	48,600	41.2	454.1	38,200	350
360	18.2	369.6		55,900	29.9	416.6	45,600	38.1	441.6	35,400	360
370	9.5	326.2		52,600	25.6	396.8	42,700	34.7	427.6	32,900	370
380					20.4	372.2	39,900	31.0	411.6	30,400	380
390					13.2	337.1	37,200	26.8	392.8	27,800	390
400								21.9	369.8	25,100	400
410								15.5	338.6	22,500	410

# MLC650 VPC-MAX S-2

ASME B30.5

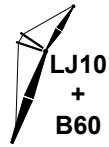

661,300 lb

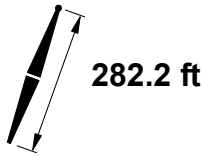

282.2 ft



311.7 ft

ft	85°				83°				80°				ft
	ft	lb	lb	lb	ft	lb	lb	lb	ft	lb	lb	lb	
120	74.6	590.8	89,000	89,000									120
125	73.6	589.3	88,800	88,800									125
130	72.7	587.8	88,600	88,600									130
135	71.7	586.1	88,300	88,300									135
140	70.7	584.3	87,900	87,900	72.6	586.5	88,200	88,200					140
145	69.7	582.4	87,600	87,600	71.6	584.9	88,100	88,100					145
150	68.7	580.4	87,100	87,100	70.7	583.1	88,000	88,000					150
155	67.7	578.3	86,700	86,700	69.7	581.2	87,800	87,800					155
160	66.7	576.2	86,200	86,200	68.7	579.2	87,600	87,600					160
165	65.7	573.9	85,700	85,700	67.7	577.1	87,300	87,300					165
170	64.7	571.5	85,200	85,200	66.7	574.9	87,000	87,000	69.6	578.7	85,800	85,800	170
175	63.7	569.0	84,600	84,600	65.7	572.6	86,700	86,700	68.6	576.7	85,800	85,800	175
180	62.6	566.4	84,000	84,000	64.7	570.2	86,300	86,300	67.6	574.6	85,800	85,800	180
185	61.6	563.6	83,500	83,500	63.6	567.7	86,000	86,000	66.6	572.4	85,800	85,800	185
190	60.5	560.8	82,900	82,900	62.6	565.1	85,600	85,600	65.6	570.1	85,800	85,800	190
195	59.5	557.8	81,500	81,500	61.6	562.4	85,100	85,100	64.6	567.7	85,800	85,800	195
200	58.4	554.7	79,600	79,600	60.5	559.5	84,700	84,700	63.6	565.2	81,900	85,800	200
205	57.3	551.4	77,700	77,700	59.4	556.5	84,200	84,200	62.5	562.5	78,000	85,600	205
210	56.2	548.0	75,900	75,900	58.3	553.4	83,800	83,800	61.5	559.8	74,300	85,500	210
215	55.1	544.5	74,000	74,000	57.2	550.1	83,300	83,300	60.4	556.9	70,700	85,300	215
220	53.9	540.8	72,100	72,100	56.1	546.8	82,300	82,800	59.3	553.9	67,300	85,100	220
230	51.6	533.0	68,500	68,500	53.9	539.5	75,300	79,700	57.2	547.5	60,900	84,600	230
240	49.2	524.5	64,900	64,900	51.5	531.7	68,800	76,000	54.9	540.6	55,100	84,100	240
250	46.7	515.2	61,500	61,500	49.1	523.2	62,900	72,400	52.6	533.0	49,700	83,500	250
260	44.0	505.0	58,300	58,300	46.6	513.8	57,400	68,800	50.2	524.8	44,700	82,900	260
270	41.3	493.8	55,200	55,200	44.0	503.7	52,300	65,500	47.8	515.9	40,100	81,300	270
280	38.4	481.5	52,400	52,400	41.2	492.5	47,500	62,200	45.2	506.1	35,900	77,900	280
290	35.2	467.7	49,900	49,900	38.3	480.1	43,100	59,200	42.5	495.4	31,900	74,500	290
300	31.8	452.1	46,200	47,800	35.2	466.3	38,900	56,400	39.7	483.6	28,100	71,200	300
310	28.0	434.2	42,000	46,000	31.8	450.7	35,000	53,900	36.6	470.5	24,600	68,000	310
320	23.7	412.8	38,000	44,600	28.0	432.7	31,300	51,800	33.4	455.8	21,300	65,000	320
330	18.4	385.7	34,200	44,100	23.6	411.2	27,800	50,200	29.8	439.0		62,300	330
340	10.6	344.6	30,400	44,100	18.3	383.9	24,400	49,200	25.7	419.3		60,000	340
350					10.4	342.3	21,000	49,200	20.9	395.1		58,200	350
360									14.6	362.3		57,300	360
370													370
380													380
390													390
400													400
410													410



# MLC650 VPC-MAX S-2

ASME B30.5

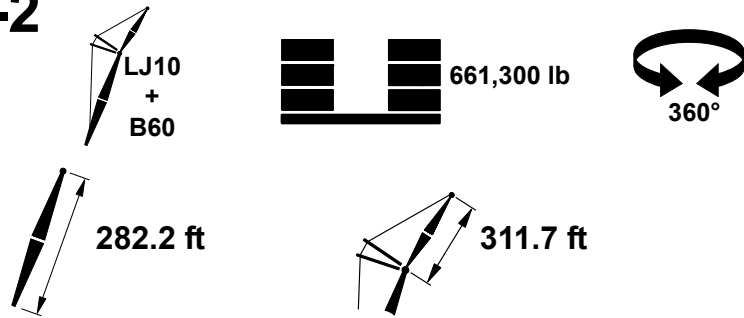

ft	75°			70°			65°			ft
	ft	lb	ft	ft	lb	ft	ft	lb	ft	
120										120
125										125
130										130
135										135
140										140
145										145
150										150
155										155
160										160
165										165
170										170
175										175
180										180
185										185
190										190
195										195
200										200
205										205
210										210
215										215
220	64.4	561.6	80,100							220
230	62.3	556.4	80,100							230
240	60.2	550.7	80,100							240
250	58.0	544.6	80,100							250
260	55.8	537.8	80,100							260
270	53.6	530.5	80,100	58.8	539.1	73,300				270
280	51.2	522.6	80,100	56.6	532.5	73,300				280
290	48.8	514.0	80,100	54.3	525.4	68,700				290
300	46.3	504.5	77,300	52.0	517.7	64,400				300
310	43.6	494.2	72,900	49.6	509.3	60,400	55.0	517.7	48,300	310
320	40.8	482.9	68,700	47.1	500.2	56,700	52.7	510.2	45,000	320
330	37.9	470.3	64,800	44.5	490.2	53,100	50.3	502.0	41,800	330
340	34.7	456.3	61,100	41.8	479.2	49,800	47.8	493.0	38,800	340
350	31.3	440.4	57,600	38.9	467.1	46,600	45.2	483.3	36,000	350
360	27.4	422.0	54,300	35.8	453.6	43,600	42.6	472.6	33,300	360
370	23.0	399.9	51,100	32.5	438.4	40,800	39.7	460.8	30,400	370
380	17.4	371.5	48,100	28.8	421.0	38,100	36.7	447.7	27,600	380
390	8.7	325.4	45,000	24.6	400.4	35,500	33.4	433.0	24,900	390
400				19.5	374.6	33,000	29.8	416.2	22,400	400
410				12.5	337.7	30,600				410

# MLC650 VPC-MAX S-2

ASME B30.5



661,300 lb



360°

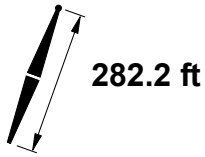

282.2 ft



331.4 ft

ft	85°				83°				80°				ft
	ft	lb	lb	lb	ft	lb	lb	lb	ft	lb	lb	lb	
125	74.6	609.9	77,200	77,200									125
130	73.7	608.4	76,900	76,900									130
135	72.8	606.8	76,700	76,700									135
140	71.9	605.2	76,400	76,400									140
145	71.0	603.4	76,200	76,200	72.8	605.6	76,200	76,200					145
150	70.1	601.6	75,800	75,800	71.9	604.0	76,200	76,200					150
155	69.1	599.6	75,500	75,500	71.0	602.2	76,000	76,000					155
160	68.2	597.6	75,000	75,000	70.0	600.3	75,800	75,800					160
165	67.3	595.5	74,600	74,600	69.1	598.4	75,600	75,600					165
170	66.3	593.2	74,200	74,200	68.2	596.4	75,400	75,400					170
175	65.4	590.9	73,700	73,700	67.2	594.2	75,100	75,100	70.0	597.8	73,700	73,700	175
180	64.4	588.5	73,200	73,200	66.3	592.0	74,800	74,800	69.0	595.9	73,700	73,700	180
185	63.4	586.0	72,800	72,800	65.3	589.7	74,500	74,500	68.1	593.9	73,700	73,700	185
190	62.5	583.3	72,200	72,200	64.4	587.3	74,100	74,100	67.2	591.7	73,700	73,700	190
195	61.5	580.6	71,700	71,700	63.4	584.7	73,800	73,800	66.2	589.5	73,700	73,700	195
200	60.5	577.7	71,200	71,200	62.4	582.1	73,500	73,500	65.3	587.1	73,700	73,700	200
205	59.5	574.7	70,300	70,300	61.4	579.3	73,100	73,100	64.3	584.7	73,600	73,600	205
210	58.5	571.6	68,800	68,800	60.4	576.5	72,700	72,700	63.3	582.2	70,200	73,400	210
215	57.4	568.4	67,200	67,200	59.4	573.5	72,300	72,300	62.3	579.5	66,700	73,300	215
220	56.4	565.1	65,600	65,600	58.4	570.4	71,900	71,900	61.4	576.8	63,300	73,100	220
230	54.3	557.9	62,400	62,400	56.3	563.8	71,000	71,000	59.4	570.9	57,000	72,800	230
240	52.1	550.2	59,400	59,400	54.2	556.6	65,100	69,200	57.3	564.5	51,200	72,300	240
250	49.8	541.9	56,300	56,300	52.0	548.9	59,200	66,200	55.2	557.6	45,800	71,900	250
260	47.5	532.9	53,400	53,400	49.8	540.6	53,700	63,100	53.0	550.2	40,900	71,300	260
270	45.1	523.0	50,600	50,600	47.4	531.5	48,700	60,100	50.8	542.2	36,300	70,800	270
280	42.5	512.3	47,900	47,900	45.0	521.7	44,000	57,200	48.5	533.4	32,100	70,200	280
290	39.9	500.6	45,500	45,500	42.5	511.0	39,600	54,400	46.2	524.0	28,100	68,300	290
300	37.0	487.6	42,800	43,300	39.8	499.2	35,400	51,700	43.7	513.7	24,400	65,400	300
310	34.0	473.2	38,700	41,300	37.0	486.2	31,600	49,300	41.1	502.4	20,900	62,600	310
320	30.7	457.0	34,800	39,500	33.9	471.8	27,900	47,000	38.3	490.0		59,900	320
330	27.0	438.2	31,100	38,100	30.6	455.5	24,500	45,100	35.4	476.3		57,300	330
340	22.8	415.9	27,600	37,100	27.0	436.7	21,200	43,400	32.2	460.9		54,900	340
350	17.6	387.6	24,200	36,700	22.7	414.3		42,100	28.7	443.4		52,700	350
360	9.9	344.3	20,800	36,700	17.5	385.8		41,500	24.8	422.8		50,800	360
370					9.7	341.9		39,000	20.1	397.7		46,600	370
380									13.9	363.3		42,400	380
390													390
400													400
410													410
420													420
430													430

# MLC650 VPC-MAX S-2

ASME B30.5

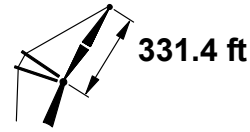
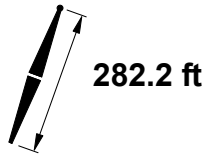
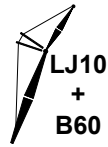

ft	75°			70°			ft
	ft	lb	ft	ft	lb	ft	
125							125
130							130
135							135
140							140
145							145
150							150
155							155
160							160
165							165
170							170
175							175
180							180
185							185
190							190
195							195
200							200
205							205
210							210
215							215
220							220
230	64.1	578.6	68,300				230
240	62.2	573.4	68,300				240
250	60.2	567.7	68,300				250
260	58.1	561.5	68,300				260
270	56.1	554.9	68,300				270
280	53.9	547.7	68,300	58.8	556.0	61,800	280
290	51.7	539.9	68,300	56.8	549.5	61,800	290
300	49.5	531.4	68,300	54.7	542.5	61,100	300
310	47.1	522.3	68,300	52.5	534.9	57,100	310
320	44.7	512.3	65,600	50.3	526.7	53,400	320
330	42.1	501.4	61,800	47.9	517.8	49,900	330
340	39.4	489.5	58,100	45.5	508.1	46,600	340
350	36.6	476.4	54,600	43.0	497.6	43,500	350
360	33.5	461.7	51,400	40.4	486.1	40,500	360
370	30.2	445.1	48,200	37.6	473.4	37,700	370
380	26.4	425.9	45,300	34.6	459.3	35,100	380
390	22.1	402.9	42,400	31.4	443.4	32,500	390
400	16.7	373.2	39,700	27.8	425.2	30,100	400
410	8.0	324.4	37,000	23.7	403.7	27,600	410
420				18.7	376.8	25,000	420
430				11.8	338.1	22,400	430

# MLC650 VPC-MAX S-2

ASME B30.5

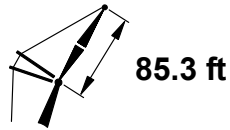
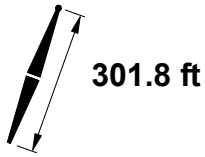

ft	85°				83°				80°				ft
	ft	lb	lb	lb	ft	lb	lb	lb	ft	lb	lb	lb	
65	72.1	391.0	348,700 d	348,700 d									65
70	68.5	388.9	336,900 d	336,900 d									70
75	64.7	386.4	333,200 c	333,200 c	72.4	390.0	352,400 d	352,400 d					75
80	60.8	383.5	328,500 c	328,500 c	68.8	387.9	340,300 d	340,300 d					80
85	56.8	380.1	323,000 b	323,000 b	65.1	385.5	337,700 c	337,700 c					85
90	52.5	376.2	319,300 b	319,300 b	61.2	382.6	333,800 c	333,800 c					90
95	47.9	371.5	313,300 b	313,300 b	57.2	379.2	329,100 b	329,100 b	69.3	385.7	308,500 c	341,700 c	95
100	43.0	366.1	309,800	309,800	52.9	375.3	319,100 b	325,000 b	65.6	383.3	289,900 c	340,800 c	100
105	37.4	359.5	303,400	303,400	48.4	370.8	300,700 b	319,900 b	61.7	380.5	273,200 c	338,400 c	105
110	30.9	351.2	295,100	295,100	43.5	365.4	283,900	316,300	57.7	377.2	257,900 b	335,400 b	110
115	22.6	339.9	284,300	290,900	38.0	359.0	268,600	314,000	53.5	373.4	244,000 b	331,300 b	115
120					31.6	350.9	254,400	309,000	49.0	368.9	231,300 b	327,500 b	120
125					23.6	340.0	241,100	302,800	44.1	363.7	219,500	324,000	125
130					8.8	318.7	228,000	302,800	38.7	357.3	208,500	321,400	130
135									32.5	349.5	198,300	313,200	135
140									24.7	339.1	188,600	299,700	140
145									12.1	321.0	179,000	286,900	145
150													150
155													155
160													160
165													165
170													170
175													175
180													180
185													185
190													190
195													195
200													200
205													205
210													210
215													215
220													220

# MLC650 VPC-MAX S-2

ASME B30.5

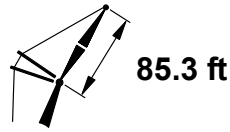
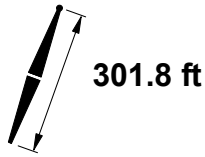

ft	75°				70°				65°				ft
	ft	°	ft	lb	ft	°	ft	lb	ft	°	ft	lb	
65													65
70													70
75													75
80													80
85													85
90													90
95													95
100													100
105													105
110													110
115													115
120													120
125													125
130	62.3	374.9	172,900 b	300,400 b									130
135	58.3	371.7	164,400 b	287,200 b									135
140	54.1	368.0	156,500 b	274,900 b									140
145	49.6	363.6	149,100 b	263,500 b									145
150	44.8	358.5	142,200	252,900									150
155	39.5	352.3	135,600	243,000									155
160	33.4	344.8	129,400	233,700	58.3	363.5	101,800 b	212,700 b					160
165	26.0	334.8	123,400	224,800	54.1	359.8	97,100 b	204,700 b					165
170	14.7	318.8	117,200	216,300	49.7	355.5	92,600 b	197,300 b					170
175					44.9	350.3	88,300	190,200					175
180					39.6	344.2	84,200	183,500					180
185					33.5	336.7	80,200	177,100					185
190					26.1	326.8	76,300	171,000	53.5	348.9	54,400 b	154,400 b	190
195					14.9	311.0	72,100	164,900	49.0	344.4	51,600	149,200	195
200									44.1	339.2	48,900	144,300	200
205									38.8	332.9	46,200	139,600	205
210									32.5	325.1	43,600	135,000	210
215									24.8	314.7	40,900	130,600	215
220									12.3	296.7	37,900	126,100	220

# MLC650 VPC-MAX S-2

ASME B30.5



661,300 lb



360°

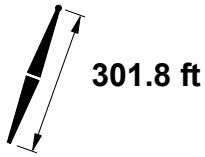

301.8 ft



95.1 ft

ft	85°				83°				80°				ft
	ft	lb	lb	lb	ft	lb	lb	lb	ft	lb	lb	lb	
65	74.0	401.4	319,100 d	319,100 d									65
70	70.8	399.6	317,200 d	317,200 d									70
75	67.5	397.4	314,400 c	314,400 c									75
80	64.2	394.9	310,500 c	310,500 c	71.1	398.6	319,800 c	319,800 c					80
85	60.7	392.0	306,100 b	306,100 b	67.9	396.4	318,300 c	318,300 c					85
90	57.1	388.6	300,800 b	300,800 b	64.5	393.9	315,400 c	315,400 c					90
95	53.3	384.8	296,800 b	296,800 b	61.0	391.1	311,600 b	311,600 b					95
100	49.3	380.4	291,600	291,600	57.4	387.8	307,500 b	307,500 b	68.3	394.2	286,600 c	320,100 c	100
105	45.0	375.3	288,000	288,000	53.6	384.0	298,200 b	303,400 b	64.9	391.8	270,000 c	319,000 c	105
110	40.3	369.3	279,300	279,300	49.7	379.6	281,600	298,500	61.5	388.9	254,900 b	316,900 b	110
115	35.0	362.2	270,500	270,500	45.4	374.6	266,400	294,900	57.9	385.7	241,100 b	313,700 b	115
120	28.9	353.3	263,800	263,800	40.8	368.7	252,500	292,200	54.1	382.0	228,400 b	310,100 b	120
125	20.9	341.0	254,200	260,400	35.6	361.7	239,600	284,200	50.2	377.7	216,800	306,400	125
130					29.5	353.0	227,700	276,500	46.0	372.8	206,000	303,100	130
135					21.8	341.2	216,400	271,800	41.4	367.0	196,000	300,200	135
140					7.1	317.2	204,900	271,800	36.3	360.2	186,700	297,700	140
145									30.4	351.7	177,900	285,300	145
150									23.0	340.5	169,500	273,700	150
155									10.6	320.6	161,000	262,700	155
160													160
165													165
170													170
175													175
180													180
185													185
190													190
195													195
200													200
205													205
210													210
215													215
220													220
230													230

# MLC650 VPC-MAX S-2

ASME B30.5

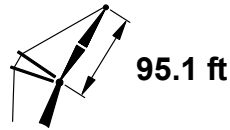
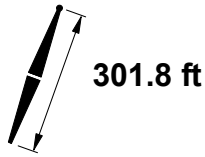
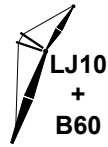

ft	75°				70°				65°				ft
	ft	°	ft	lb	ft	°	ft	lb	ft	°	ft	lb	
65													65
70													70
75													75
80													80
85													85
90													90
95													95
100													100
105													105
110													110
115													115
120													120
125													125
130													130
135	62.0	383.4	161,000 b	284,300 b									135
140	58.4	380.2	153,200 b	272,100 b									140
145	54.7	376.5	146,000 b	260,900 b									145
150	50.7	372.3	139,200	250,400									150
155	46.6	367.5	132,800	240,600									155
160	42.0	361.9	126,700	231,400									160
165	37.0	355.2	121,000	222,700	58.4	372.0	93,600 b	201,900 b					165
170	31.3	347.0	115,500	214,500	54.7	368.4	89,200	194,500					170
175	24.1	336.3	110,100	206,700	50.8	364.2	85,000	187,600					175
180	13.2	318.9	104,700	199,200	46.6	359.4	81,100	181,000					180
185					42.1	353.8	77,300	174,700					185
190					37.1	347.1	73,600	168,800					190
195					31.3	339.0	70,000	163,100	54.2	357.5	48,000	146,500	195
200					24.3	328.3	66,500	157,600	50.2	353.2	45,400	141,600	200
205					13.5	311.1	62,800	152,200	46.0	348.3	42,900	137,000	205
210									41.4	342.5	40,500	132,600	210
215									36.3	335.7	38,100	128,400	215
220									30.4	327.3	35,800	124,300	220
230									10.8	296.3	30,600	116,100	230

# MLC650 VPC-MAX S-2

ASME B30.5



661,300 lb



360°

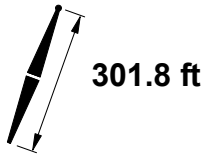

301.8 ft

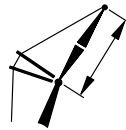

105.0 ft

ft	85°				83°				80°				ft
	ft	ft	lb	lb	ft	lb	lb	ft	lb	lb			
70	72.7	410.1	298,900 c	298,900 c									70
75	69.8	408.2	297,100 c	297,100 c									75
80	66.8	405.9	294,100 c	294,100 c	73.0	409.1	300,700 c	300,700 c					80
85	63.7	403.4	290,300 b	290,300 b	70.1	407.2	300,300 c	300,300 c					85
90	60.6	400.4	286,100 b	286,100 b	67.1	404.9	298,400 c	298,400 c					90
95	57.3	397.1	281,100 b	281,100 b	64.0	402.4	295,400 b	295,400 b					95
100	53.9	393.4	276,600	276,600	60.9	399.5	291,900 b	291,900 b					100
105	50.3	389.1	272,600	272,600	57.6	396.3	287,900 b	287,900 b	67.5	402.7	268,200 b	300,700 b	105
110	46.5	384.3	267,700	267,700	54.2	392.6	280,300	283,600	64.4	400.2	253,100 b	299,400 b	110
115	42.5	378.8	258,000	258,000	50.7	388.4	265,300	279,700	61.3	397.4	239,400 b	297,100 b	115
120	38.0	372.3	249,300	249,300	46.9	383.6	251,500	276,200	58.0	394.2	226,900 b	294,300 b	120
125	33.0	364.7	242,100	242,100	42.9	378.1	238,800	272,500	54.7	390.5	215,400	291,200	125
130	27.1	355.1	236,700	236,700	38.5	371.8	227,100	263,300	51.1	386.4	204,700	287,800	130
135	19.5	342.0	229,800	234,500	33.5	364.3	216,100	255,300	47.4	381.7	194,800	284,600	135
140					27.8	354.9	205,900	249,000	43.4	376.4	185,600	281,800	140
145					20.4	342.3	196,100	245,500	39.0	370.1	177,000	279,700	145
150					5.1	314.8	186,000	245,500	34.2	362.8	168,900	272,800	150
155									28.6	353.8	161,300	262,100	155
160									21.5	341.7	153,900	252,100	160
165									9.2	319.9	146,400	242,300	165
170													170
175													175
180													180
185													185
190													190
195													195
200													200
205													205
210													210
215													215
220													220
230													230
240													240



# MLC650 VPC-MAX S-2

ASME B30.5

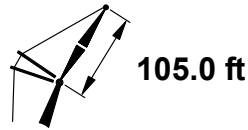
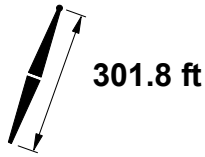

ft	75°				70°				65°				ft
	ft	°	ft	lb	ft	°	ft	lb	ft	°	ft	lb	
70													70
75													75
80													80
85													85
90													90
95													95
100													100
105													105
110													110
115													115
120													120
125													125
130													130
135	64.8	394.6	159,000 b	282,500 b									135
140	61.7	391.8	151,300 b	270,400 b									140
145	58.5	388.7	144,200 b	259,200 b									145
150	55.1	385.1	137,500	248,800									150
155	51.6	381.0	131,200	239,100									155
160	47.9	376.4	125,200	230,000									160
165	44.0	371.2	119,600	221,400									165
170	39.7	365.1	114,300	213,300	58.5	380.5	87,200	192,900					170
175	34.9	357.9	109,200	205,700	55.2	377.0	83,100	186,000					175
180	29.4	349.2	104,400	198,500	51.7	372.9	79,300	179,500					180
185	22.6	337.7	99,600	191,600	48.0	368.3	75,600	173,300					185
190	11.9	318.8	94,700	184,900	44.0	363.1	72,100	167,400					190
195					39.7	357.0	68,700	161,900					195
200					35.0	349.8	65,400	156,600	54.7	366.0	43,500	140,000	200
205					29.5	341.1	62,200	151,500	51.2	361.9	41,100	135,500	205
210					22.7	329.7	59,000	146,500	47.4	357.2	38,700	131,100	210
215					12.2	311.1	55,600	141,600	43.4	351.9	36,500	127,000	215
220									39.1	345.7	34,300	123,000	220
230									28.6	329.3	30,000	115,400	230
240									9.4	295.7	25,200	108,000	240

# MLC650 VPC-MAX S-2

ASME B30.5



661,300 lb



360°

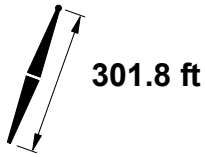

301.8 ft



114.8 ft

ft	85°				83°				80°				ft
	ft	lb	lb	lb	ft	lb	lb	lb	ft	lb	lb	lb	
70	74.2	420.5	279,600 c	279,600 c									70
75	71.6	418.7	279,600 c	279,600 c									75
80	68.9	416.7	276,100 b	276,100 b									80
85	66.2	414.4	273,200 b	273,200 b	71.9	417.7	280,500 c	280,500 c					85
90	63.4	411.8	269,700 b	269,700 b	69.2	415.7	279,600 b	279,600 b					90
95	60.5	408.9	265,600 b	265,600 b	66.4	413.5	277,600 b	277,600 b					95
100	57.5	405.6	262,500	262,500	63.6	410.9	274,900 b	274,900 b					100
105	54.4	402.0	257,500	257,500	60.8	408.0	271,500 b	271,500 b	69.5	413.5	264,800 b	280,400 b	105
110	51.2	397.9	253,800	253,800	57.8	404.8	268,300	268,300	66.8	411.2	249,900 b	280,200 b	110
115	47.8	393.2	247,800	247,800	54.7	401.1	262,700	264,300	64.0	408.7	236,300 b	278,900 b	115
120	44.2	388.0	238,800	238,800	51.5	397.1	249,000	260,800	61.1	405.9	223,800 b	277,000 b	120
125	40.3	382.1	230,500	230,500	48.1	392.5	236,400	257,600	58.2	402.7	212,400	274,400	125
130	36.0	375.2	223,400	223,400	44.5	387.3	224,700	253,100	55.1	399.1	201,800	271,700	130
135	31.3	367.0	217,300	217,300	40.7	381.5	214,000	244,400	51.9	395.1	192,000	268,700	135
140	25.6	356.8	213,200	213,200	36.5	374.7	203,900	236,600	48.6	390.6	182,900	265,900	140
145	18.2	342.9	207,300	211,900	31.8	366.6	194,500	230,000	45.0	385.5	174,400	263,200	145
150					26.2	356.7	185,600	224,900	41.2	379.7	166,500	261,100	150
155					19.1	343.3	177,100	222,400	37.0	373.1	159,000	255,900	155
160									32.4	365.2	151,900	248,600	160
165									27.0	355.6	145,200	240,800	165
170									20.1	342.8	138,700	231,900	170
175									8.0	319.0	132,000	223,300	175
180													180
185													185
190													190
195													195
200													200
205													205
210													210
215													215
220													220
230													230
240													240
250													250

# MLC650 VPC-MAX S-2

ASME B30.5

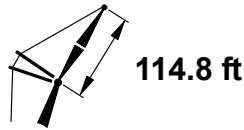
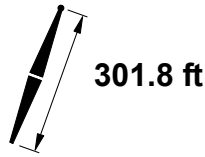

ft	75°				70°				65°				ft
	ft	°	ft	lb	ft	°	ft	lb	ft	°	ft	lb	
70													70
75													75
80													80
85													85
90													90
95													95
100													100
105													105
110													110
115													115
120													120
125													125
130													130
135													135
140	64.4	403.1	147,900	267,600									140
145	61.5	400.3	140,800	256,400									145
150	58.6	397.2	134,100	246,100									150
155	55.5	393.6	127,900	236,400									155
160	52.4	389.7	122,100	227,400									160
165	49.0	385.3	116,600	218,900									165
170	45.5	380.3	111,400	210,900									170
175	41.7	374.6	106,400	203,400	58.6	389.0	79,600	183,200					175
180	37.6	368.1	101,700	196,300	55.6	385.5	75,800	176,700					180
185	33.1	360.4	97,200	189,500	52.4	381.6	72,200	170,600					185
190	27.8	351.1	92,900	183,100	49.1	377.1	68,800	164,800					190
195	21.2	338.9	88,600	176,900	45.6	372.2	65,500	159,300					195
200	10.8	318.5	84,100	170,900	41.8	366.5	62,400	154,100					200
205					37.7	360.0	59,300	149,100					205
210					33.2	352.4	56,400	144,300	51.9	370.6	128,400		210
215					27.9	343.1	53,500	139,800	48.6	366.1	124,300		215
220					21.3	331.0	50,600	135,300	45.0	361.0	120,400		220
230									37.1	348.6	113,000		230
240									27.0	331.2	106,200		240
250									8.1	294.8	99,300		250

# MLC650 VPC-MAX S-2

ASME B30.5



661,300 lb

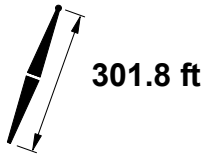

301.8 ft

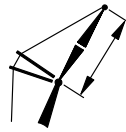

124.7 ft

ft	85°				83°				80°				ft
	ft	ft	lb	lb	ft	lb	lb	ft	lb	lb	ft		
75	73.1	429.2	263,700 c	263,700 c									75
80	70.7	427.4	262,200 b	262,200 b									80
85	68.2	425.3	260,000 b	260,000 b									85
90	65.6	422.9	257,100 b	257,100 b	70.9	426.3	264,900 b	264,900 b					90
95	63.1	420.3	253,600 b	253,600 b	68.4	424.3	263,700 b	263,700 b					95
100	60.4	417.4	250,000	250,000	65.9	422.0	261,700 b	261,700 b					100
105	57.7	414.1	246,200	246,200	63.3	419.4	259,100 b	259,100 b					105
110	54.8	410.5	242,600	242,600	60.7	416.5	256,000	256,000	68.7	422.0	249,900 b	265,100 b	110
115	51.9	406.5	239,100	239,100	57.9	413.3	253,100	253,100	66.2	419.8	236,300 b	264,600 b	115
120	48.8	402.1	231,300	231,300	55.1	409.7	249,300	249,400	63.6	417.2	223,900	263,400	120
125	45.6	397.1	223,000	223,000	52.2	405.7	236,800	246,200	61.0	414.3	212,500	261,500	125
130	42.1	391.5	215,200	215,200	49.1	401.3	225,200	243,200	58.3	411.2	202,000	261,500	130
135	38.4	385.2	208,200	208,200	45.9	396.4	214,500	237,100	55.5	407.6	192,200	256,800	135
140	34.3	377.8	202,100	202,100	42.5	390.9	204,600	229,000	52.5	403.7	183,200	254,100	140
145	29.7	369.2	197,200	197,200	38.8	384.6	195,300	221,500	49.5	399.4	174,800	251,500	145
150	24.3	358.4	193,900	193,900	34.7	377.4	186,600	214,900	46.3	394.5	166,900	249,000	150
155	17.1	343.6	190,400	193,300	30.2	368.9	178,400	209,300	42.9	389.1	159,600	246,900	155
160					24.9	358.4	170,600	205,200	39.3	382.9	152,600	240,900	160
165					18.0	344.2	163,100	203,400	35.3	375.9	146,000	233,700	165
170									30.8	367.5	139,800	227,400	170
175									25.6	357.4	133,900	222,200	175
180									19.0	343.8	128,100	216,300	180
185									6.7	317.6	122,000	208,600	185
190													190
195													195
200													200
205													205
210													210
215													215
220													220
230													230
240													240
250													250
260													260

# MLC650 VPC-MAX S-2

ASME B30.5

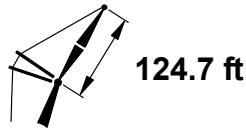
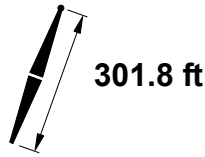

ft	75°				70°				65°				ft
	ft	°	ft	lb	ft	°	ft	lb	ft	°	ft	lb	
75													75
80													80
85													85
90													90
95													95
100													100
105													105
110													110
115													115
120													120
125													125
130													130
135													135
140													140
145	64.0	411.6	140,800	256,100									145
150	61.4	408.8	134,200	245,800									150
155	58.7	405.7	128,000	236,200									155
160	55.9	402.2	122,200	227,200									160
165	53.0	398.3	116,800	218,800									165
170	49.9	394.0	111,600	210,900									170
175	46.8	389.3	106,800	203,400									175
180	43.4	383.9	102,100	196,300	58.7	397.5	75,800	176,600					180
185	39.8	377.9	97,700	189,700	55.9	394.0	72,300	170,500					185
190	35.9	370.9	93,500	183,300	53.0	390.2	68,900	164,800					190
195	31.5	362.8	89,500	177,300	50.0	385.9	65,700	159,300					195
200	26.4	352.9	85,600	171,500	46.8	381.1	62,600	154,100					200
205	20.0	340.0	81,700	166,000	43.4	375.8	59,600	149,200					205
210	9.7	318.1	77,600	160,500	39.8	369.8	56,800	144,500					210
215					35.9	362.8	54,000	140,000	52.6	379.2	124,300		215
220					31.6	354.7	51,400	135,700	49.5	374.9	120,400		220
230					20.2	332.1	46,100	127,400	42.9	364.6	113,100		230
240									35.3	351.4	106,400		240
250									25.7	332.9	100,100		250
260									6.9	293.5	93,800		260

# MLC650 VPC-MAX S-2

ASME B30.5

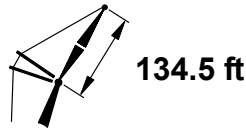
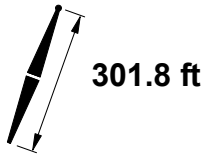

ft	85°				83°				80°				ft
	ft	lb	lb	lb	ft	lb	lb	lb	ft	lb	lb	lb	
75	74.4	439.5	248,400 c	248,400 c									75
80	72.2	437.9	247,500 b	247,500 b									80
85	69.9	436.0	245,800 b	245,800 b									85
90	67.6	433.8	243,600 b	243,600 b	72.4	436.8	249,400 b	249,400 b					90
95	65.2	431.4	240,900 b	240,900 b	70.1	434.9	248,800 b	248,800 b					95
100	62.8	428.8	237,600	237,600	67.8	432.8	247,400 b	247,400 b					100
105	60.3	425.9	234,200	234,200	65.4	430.5	245,500	245,500					105
110	57.8	422.6	231,400	231,400	63.0	427.8	243,100	243,100					110
115	55.2	419.1	227,500	227,500	60.6	424.9	240,200	240,200	68.1	430.6	233,100	249,000	115
120	52.5	415.2	223,000	223,000	58.0	421.7	237,600	237,600	65.7	428.3	220,800	248,500	120
125	49.7	410.8	214,900	214,900	55.4	418.2	234,100	234,300	63.3	425.7	209,400	247,400	125
130	46.7	406.1	207,200	207,200	52.7	414.3	222,600	231,300	60.9	422.8	199,000	245,600	130
135	43.6	400.8	200,000	200,000	49.9	410.1	212,000	228,600	58.4	419.7	189,300	243,700	135
140	40.3	394.8	193,300	193,300	47.0	405.3	202,100	221,100	55.8	416.2	180,300	241,500	140
145	36.7	388.1	187,400	187,400	43.9	400.1	192,900	213,600	53.1	412.4	172,000	239,000	145
150	32.8	380.4	182,300	182,300	40.6	394.2	184,300	206,500	50.3	408.1	164,200	236,700	150
155	28.4	371.2	178,300	178,300	37.1	387.6	176,200	200,100	47.4	403.5	156,900	234,400	155
160	23.1	359.9	175,800	175,800	33.2	379.9	168,600	194,500	44.3	398.3	150,000	232,400	160
165	16.1	344.3	172,900	175,700	28.8	371.0	161,400	189,800	41.1	392.5	143,500	225,800	165
170					23.7	359.9	154,600	186,500	37.6	385.9	137,400	218,900	170
175					16.9	344.9	147,900	185,300	33.7	378.5	131,600	212,600	175
180									29.4	369.7	126,100	207,200	180
185									24.4	359.0	120,800	202,800	185
190									17.9	344.7	115,600	200,100	190
195									5.4	315.7	110,000	193,200	195
200													200
205													205
210													210
215													215
220													220
230													230
240													240
250													250
260													260
270													270

# MLC650 VPC-MAX S-2

ASME B30.5

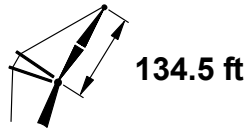
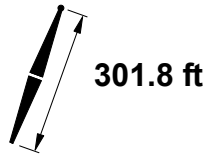

ft	75°				70°				65°					
	ft	°	ft	lb	ft	°	ft	lb	ft	°	ft	lb	ft	
75														75
80														80
85														85
90														90
95														95
100														100
105														105
110														110
115														115
120														120
125														125
130														130
135														135
140														140
145														145
150	63.7	420.1	130,800	243,100										150
155	61.2	417.2	124,700	233,500										155
160	58.7	414.1	118,900	224,600										160
165	56.1	410.7	113,600	216,200										165
170	53.5	406.9	108,500	208,300										170
175	50.7	402.8	103,700	200,900										175
180	47.8	398.2	99,100	193,900										180
185	44.8	393.0	94,800	187,300	58.8	406.0	68,800	167,800						185
190	41.5	387.3	90,700	181,000	56.2	402.6	65,500	162,100						190
195	38.1	380.9	86,800	175,100	53.5	398.8	62,300	156,700						195
200	34.3	373.6	83,000	169,400	50.7	394.6	59,300	151,500						200
205	30.1	365.0	79,400	164,000	47.8	390.0	56,400	146,700						205
210	25.2	354.6	75,800	158,800	44.8	384.9	53,700	142,000						210
215	19.0	341.0	72,300	153,800	41.6	379.2	51,000	137,600						215
220	8.7	317.4	68,600	148,800	38.1	372.8	48,400	133,300	53.1	387.8	117,700			220
230					30.1	357.0	43,500	125,300	47.4	379.0	110,500			230
240					19.1	333.1	38,700	117,800	41.1	368.0	103,900			240
250									33.8	354.0	97,800			250
260									24.4	334.5	92,000			260
270									5.6	291.7	86,200			270

# MLC650 VPC-MAX S-2

ASME B30.5

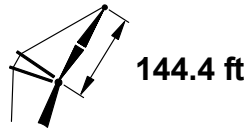
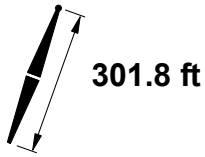
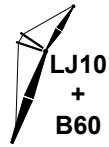

ft	85°				83°				80°				ft
	ft	lb	lb	lb	ft	lb	lb	lb	ft	lb	lb	lb	
80	73.4	448.3	233,700 b	233,700 b									80
85	71.3	446.5	232,600 b	232,600 b									85
90	69.2	444.5	230,900 b	230,900 b									90
95	67.0	442.3	228,700	228,700	71.5	445.5	234,800 b	234,800 b					95
100	64.8	439.9	226,200	226,200	69.4	443.5	234,100	234,100					100
105	62.6	437.3	223,100	223,100	67.2	441.4	232,700	232,700					105
110	60.3	434.3	220,000	220,000	65.0	439.0	230,800	230,800					110
115	57.9	431.1	216,900	216,900	62.8	436.3	228,600	228,600	69.7	441.3	231,000	234,300	115
120	55.5	427.6	213,900	213,900	60.5	433.4	226,200	226,200	67.5	439.1	218,600	234,300	120
125	53.0	423.8	207,800	207,800	58.1	430.2	223,300	223,300	65.3	436.8	207,300	233,900	125
130	50.4	419.6	200,400	200,400	55.7	426.8	220,600	220,600	63.1	434.2	196,900	232,800	130
135	47.7	415.0	193,300	193,300	53.2	422.9	210,300	217,900	60.8	431.3	187,300	231,300	135
140	44.9	409.9	186,600	186,600	50.6	418.8	200,400	214,200	58.4	428.1	178,400	229,600	140
145	41.9	404.2	180,300	180,300	48.0	414.2	191,300	206,900	56.0	424.7	170,100	227,600	145
150	38.7	398.0	174,700	174,700	45.1	409.2	182,700	199,900	53.6	420.9	162,300	225,400	150
155	35.2	390.9	169,600	169,600	42.2	403.6	174,700	193,300	51.0	416.8	155,000	223,300	155
160	31.5	382.7	165,300	165,300	39.0	397.4	167,200	187,300	48.3	412.3	148,200	221,200	160
165	27.2	373.2	162,100	162,100	35.6	390.4	160,100	181,700	45.5	407.3	141,800	219,100	165
170	22.1	361.3	160,100	160,100	31.8	382.4	153,400	176,900	42.6	401.8	135,800	212,300	170
175	15.2	344.8	157,900	160,100	27.6	373.0	147,000	172,900	39.4	395.7	130,100	205,800	175
180					22.6	361.4	140,900	170,300	36.0	388.8	124,600	199,800	180
185					16.0	345.6	134,900	169,600	32.3	380.9	119,500	194,300	185
190									28.2	371.7	114,500	189,600	190
195									23.3	360.5	109,700	186,000	195
200									17.0	345.5	105,000	184,000	200
205									3.8	312.5	99,900	179,900	205
210													210
215													215
220													220
230													230
240													240
250													250
260													260
270													270
280													280



# MLC650 VPC-MAX S-2

ASME B30.5

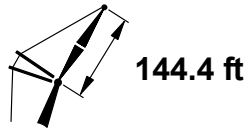
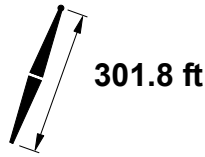

ft	75°				70°				65°				ft
	ft	°	ft	lb	ft	°	ft	lb	ft	°	ft	lb	
80													80
85													85
90													90
95													95
100													100
105													105
110													110
115													115
120													120
125													125
130													130
135													135
140													140
145													145
150													150
155	63.4	428.6	122,500	230,100									155
160	61.1	425.7	116,800	222,700									160
165	58.8	422.6	111,400	214,400									165
170	56.4	419.2	106,400	206,600									170
175	53.9	415.5	101,600	199,200									175
180	51.3	411.4	97,100	192,200									180
185	48.7	407.0	92,900	185,600									185
190	45.9	402.1	88,800	179,400	58.8	414.5	63,300	160,300					190
195	43.0	396.6	84,900	173,500	56.4	411.1	60,100	154,900					195
200	39.9	390.6	81,300	167,900	53.9	407.4	57,200	149,800					200
205	36.5	383.8	77,700	162,500	51.4	403.3	54,300	145,000					205
210	32.9	376.1	74,300	157,400	48.7	398.8	51,600	140,300					210
215	28.8	367.1	71,000	152,600	45.9	393.9	49,000	135,900					215
220	24.0	356.2	67,800	147,900	43.0	388.5	46,500	131,700					220
230	7.7	316.5	61,100	138,800	36.6	375.7	41,700	123,800	51.0	392.3	108,800		230
240					28.9	359.1	37,200	116,500	45.5	382.8	102,300		240
250					18.1	334.0	32,800	109,700	39.4	371.2	96,200		250
260									32.4	356.5	90,600		260
270									23.3	336.1	85,300		270
280									4.1	288.9	79,800		280

# MLC650 VPC-MAX S-2

ASME B30.5

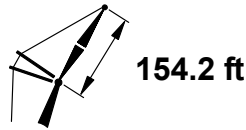
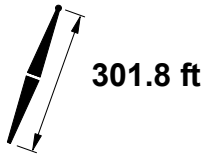

ft	85°				83°				80°				ft
	ft	lb	lb	lb	ft	lb	lb	lb	ft	lb	lb	lb	
80	74.5	458.6	220,200 b	220,200 b									80
85	72.6	457.0	219,600 b	219,600 b									85
90	70.6	455.1	218,400	218,400									90
95	68.6	453.1	216,600	216,600	72.8	455.9	221,100 b	221,100 b					95
100	66.5	450.9	214,600	214,600	70.8	454.1	220,800	220,800					100
105	64.5	448.4	212,100	212,100	68.8	452.1	219,900	219,900					105
110	62.4	445.7	209,300	209,300	66.7	449.9	218,600	218,600					110
115	60.2	442.8	206,600	206,600	64.7	447.5	216,800	216,800					115
120	58.0	439.6	203,800	203,800	62.6	444.8	214,700	214,700	69.0	449.9	215,500	220,400	120
125	55.8	436.1	200,500	200,500	60.4	441.9	212,400	212,400	67.0	447.7	204,200	220,400	125
130	53.4	432.4	193,500	193,500	58.2	438.7	210,000	210,000	64.9	445.3	193,900	219,900	130
135	51.0	428.3	186,700	186,700	56.0	435.3	207,500	207,500	62.8	442.6	184,300	218,900	135
140	48.5	423.8	180,200	180,200	53.7	431.5	197,800	205,100	60.7	439.8	175,400	217,600	140
145	45.9	418.9	174,000	174,000	51.3	427.5	188,700	200,200	58.5	436.6	167,100	216,000	145
150	43.2	413.5	168,300	168,300	48.8	423.0	180,200	193,600	56.3	433.2	159,400	214,200	150
155	40.3	407.6	162,900	162,900	46.2	418.2	172,300	187,100	54.0	429.5	152,200	212,300	155
160	37.2	401.0	158,000	158,000	43.5	412.8	164,800	180,900	51.6	425.5	145,500	210,500	160
165	33.9	393.5	153,700	153,700	40.6	406.9	157,800	175,200	49.1	421.1	139,100	208,600	165
170	30.2	385.0	150,100	150,100	37.5	400.4	151,200	169,900	46.5	416.3	133,100	205,900	170
175	26.1	375.0	147,400	147,400	34.2	393.1	144,900	165,200	43.8	411.0	127,500	199,600	175
180	21.1	362.6	146,000	146,000	30.6	384.7	138,900	161,000	41.0	405.2	122,100	193,500	180
185	14.4	345.3	143,700	146,000	26.5	374.8	133,200	157,700	37.9	398.8	117,000	187,700	185
190					21.6	362.7	127,800	155,600	34.7	391.5	112,200	182,500	190
195					15.2	346.1	122,400	155,300	31.1	383.3	107,500	177,700	195
200									27.1	373.7	103,100	173,700	200
205									22.3	361.9	98,800	170,700	205
210									16.2	346.1	94,500	169,200	210
215													215
220													220
230													230
240													240
250													250
260													260
270													270
280													280

# MLC650 VPC-MAX S-2

ASME B30.5

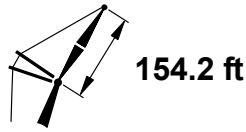
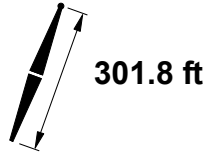
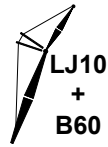

ft	75°				70°				65°				ft
	ft	ft	lb	lb	ft	ft	lb	lb	ft	ft	lb	lb	
80													80
85													85
90													90
95													95
100													100
105													105
110													110
115													115
120													120
125													125
130													130
135													135
140													140
145													145
150													150
155													155
160	63.1	437.0	113,500	216,000									160
165	61.0	434.2	108,200	211,800									165
170	58.8	431.1	103,200	204,000									170
175	56.6	427.7	98,500	196,600									175
180	54.3	424.1	94,000	189,700									180
185	51.9	420.1	89,800	183,200									185
190	49.4	415.7	85,800	177,000									190
195	46.9	411.0	82,000	171,100	58.9	423.0	56,700	152,200					195
200	44.2	405.8	78,400	165,600	56.6	419.6	53,800	147,200					200
205	41.4	400.1	74,900	160,300	54.3	415.9	51,000	142,400					205
210	38.4	393.7	71,600	155,200	51.9	412.0	48,300	137,800					210
215	35.1	386.6	68,400	150,400	49.5	407.6	45,800	133,400					215
220	31.6	378.5	65,300	145,800	46.9	402.9	43,300	129,300					220
230	23.0	357.7	59,300	137,100	41.4	392.0	38,700	121,500	54.0	405.0	106,100		230
240	6.8	315.3	53,200	128,700	35.2	378.5	34,400	114,300	49.1	396.6	99,700		240
250					27.7	361.1	30,300	107,600	43.8	386.5	93,700		250
260					17.3	334.8	26,200	101,300	38.0	374.3	88,200		260
270									31.1	358.8	83,000		270
280									22.4	337.5	78,100		280

# MLC650 VPC-MAX S-2

ASME B30.5



661,300 lb

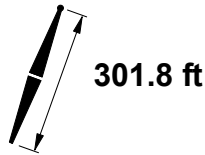

301.8 ft

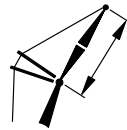

164.0 ft

ft	85°				83°				80°				ft
	ft	lb	lb	lb	ft	lb	lb	lb	ft	lb	lb	lb	
85	73.6	467.3	207,700 b	207,700 b									85
90	71.8	465.6	206,900	206,900									90
95	69.9	463.7	205,700	205,700									95
100	68.0	461.7	204,000	204,000	72.0	464.6	208,700	208,700					100
105	66.1	459.4	202,000	202,000	70.1	462.7	208,200	208,200					105
110	64.2	456.9	199,600	199,600	68.2	460.7	207,300	207,300					110
115	62.2	454.2	197,100	197,100	66.3	458.4	206,000	206,000					115
120	60.2	451.3	195,300	195,300	64.4	455.9	204,400	204,400					120
125	58.1	448.1	192,000	192,000	62.4	453.3	202,600	202,600	68.5	458.4	203,300	207,900	125
130	56.0	444.7	187,600	187,600	60.4	450.4	200,600	200,600	66.6	456.2	192,900	207,800	130
135	53.8	440.9	181,300	181,300	58.3	447.2	198,100	198,100	64.6	453.8	183,400	207,300	135
140	51.6	436.9	174,900	174,900	56.2	443.8	195,900	195,900	62.6	451.1	174,500	206,400	140
145	49.2	432.5	168,900	168,900	54.0	440.1	188,100	193,600	60.6	448.2	166,300	205,300	145
150	46.8	427.8	163,200	163,200	51.8	436.1	179,700	188,100	58.6	445.1	158,600	203,900	150
155	44.3	422.6	157,700	157,700	49.5	431.8	171,700	181,900	56.5	441.7	151,400	202,300	155
160	41.7	417.0	152,700	152,700	47.1	427.1	164,300	176,000	54.3	438.1	144,700	200,600	160
165	38.9	410.7	148,000	148,000	44.6	421.9	157,300	170,200	52.1	434.1	138,400	198,900	165
170	35.9	403.8	143,800	143,800	42.0	416.3	150,800	164,800	49.8	429.8	132,400	197,200	170
175	32.7	396.0	140,100	140,100	39.2	410.2	144,500	159,700	47.4	425.2	126,800	194,300	175
180	29.1	387.2	137,000	137,000	36.2	403.3	138,700	155,100	44.9	420.1	121,500	188,500	180
185	25.1	376.7	134,800	134,800	33.0	395.6	133,100	150,900	42.3	414.6	116,500	182,700	185
190	20.2	363.8	133,700	133,700	29.5	386.9	127,700	147,300	39.5	408.5	111,700	177,300	190
195	13.7	345.6	132,600	133,700	25.5	376.6	122,600	144,600	36.6	401.7	107,100	172,200	195
200					20.8	364.0	117,700	142,700	33.4	394.2	102,800	167,500	200
205					14.4	346.6	112,800	142,700	30.0	385.5	98,600	163,200	205
210									26.0	375.5	94,500	159,800	210
215									21.4	363.2	90,600	157,100	215
220									15.4	346.7	86,700	155,900	220
230													230
240													240
250													250
260													260
270													270
280													280
290													290

# MLC650 VPC-MAX S-2

ASME B30.5

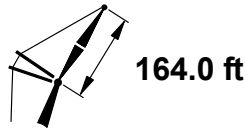
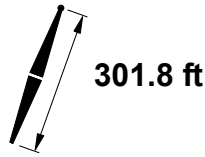
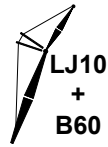

ft	75°				70°				65°				
	ft	ft	lb	lb	ft	ft	lb	lb	ft	ft	lb	lb	
85													85
90													90
95													95
100													100
105													105
110													110
115													115
120													120
125													125
130													130
135													135
140													140
145													145
150													150
155													155
160	64.9	448.1	112,400	202,100									160
165	62.9	445.5	107,100	202,100									165
170	60.9	442.7	102,200	202,100									170
175	58.9	439.6	97,500	195,700									175
180	56.8	436.2	93,100	188,800									180
185	54.6	432.6	88,900	182,300									185
190	52.4	428.7	84,900	176,200									190
195	50.1	424.5	81,200	170,400									195
200	47.7	419.9	77,600	164,800	58.9	431.4	52,700	146,200					200
205	45.3	414.9	74,100	159,500	56.8	428.1	49,900	141,500					205
210	42.7	409.4	70,900	154,500	54.6	424.5	47,300	136,900					210
215	39.9	403.4	67,700	149,700	52.4	420.6	44,800	132,600					215
220	37.0	396.7	64,700	145,200	50.1	416.3	42,400	128,400					220
230	30.5	380.8	59,000	136,600	45.3	406.7	37,800	120,700					230
240	22.1	359.1	53,500	128,600	40.0	395.3	33,600	113,600	52.1	409.6	98,800		240
250	5.8	313.8	47,800	121,000	33.9	381.2	29,700	107,000	47.4	400.7	92,900		250
260					26.7	363.0	25,900	100,900	42.3	390.1	87,500		260
270					16.5	335.5	22,100	95,100	36.6	377.2	82,400		270
280									30.0	361.1	77,600		280
290									21.5	338.8	73,000		290

# MLC650 VPC-MAX S-2

ASME B30.5



661,300 lb

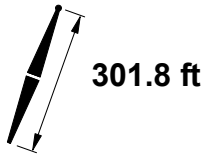

301.8 ft



173.9 ft

ft	85°				83°				80°				ft
	ft	lb	lb	lb	ft	lb	lb	lb	ft	lb	lb	lb	
85	74.6	477.6	195,800 b	195,800 b									85
90	72.9	476.0	195,400	195,400									90
95	71.1	474.3	194,500	194,500									95
100	69.4	472.3	193,200	193,200									100
105	67.6	470.2	191,600	191,600	71.3	473.2	196,300	196,300					105
110	65.8	467.9	189,700	189,700	69.5	471.3	195,800	195,800					110
115	63.9	465.4	187,700	187,700	67.7	469.2	194,900	194,900					115
120	62.0	462.7	185,600	185,600	65.9	466.9	193,700	193,700					120
125	60.1	459.8	182,900	182,900	64.1	464.4	192,200	192,200	69.8	469.1	195,200	195,200	125
130	58.2	456.6	180,600	180,600	62.2	461.7	190,500	190,500	68.0	467.0	189,800	195,200	130
135	56.2	453.2	175,100	175,100	60.3	458.8	188,700	188,700	66.2	464.7	180,300	195,200	135
140	54.1	449.5	169,100	169,100	58.4	455.7	186,900	186,900	64.3	462.3	171,500	195,000	140
145	52.0	445.6	163,400	163,400	56.4	452.3	184,500	184,500	62.5	459.6	163,300	194,200	145
150	49.9	441.3	157,900	157,900	54.3	448.7	177,100	182,000	60.6	456.7	155,700	193,200	150
155	47.6	436.7	152,600	152,600	52.2	444.7	169,200	176,200	58.6	453.6	148,600	191,900	155
160	45.3	431.7	147,600	147,600	50.1	440.5	161,800	170,500	56.6	450.2	141,900	190,700	160
165	42.9	426.2	142,900	142,900	47.9	435.9	154,900	165,000	54.6	446.6	135,600	189,100	165
170	40.3	420.3	138,500	138,500	45.5	431.0	148,300	159,700	52.5	442.7	129,700	187,600	170
175	37.6	413.8	134,400	134,400	43.1	425.6	142,200	154,600	50.4	438.5	124,100	186,100	175
180	34.7	406.6	130,800	130,800	40.6	419.7	136,300	149,900	48.1	434.0	118,800	182,900	180
185	31.6	398.5	127,700	127,700	37.9	413.2	130,800	145,500	45.8	429.1	113,800	177,500	185
190	28.1	389.2	125,100	125,100	35.0	406.1	125,500	141,400	43.4	423.8	109,100	172,200	190
195	24.2	378.3	123,200	123,200	31.9	398.1	120,500	137,800	40.9	418.0	104,600	167,100	195
200	19.4	364.9	122,400	122,400	28.5	389.0	115,700	134,800	38.2	411.6	100,300	162,300	200
205	13.0	345.8	120,700	122,400	24.6	378.3	111,100	132,500	35.4	404.5	96,200	157,700	205
210					19.9	365.1	106,600	131,100	32.3	396.7	92,200	153,600	210
215					13.7	346.9	102,200	131,100	28.9	387.7	88,400	150,000	215
220									25.1	377.2	84,800	147,000	220
230									14.7	347.2	77,600	144,000	230
240													240
250													250
260													260
270													270
280													280
290													290
300													300

# MLC650 VPC-MAX S-2

ASME B30.5

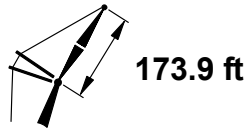
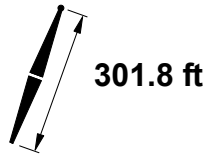
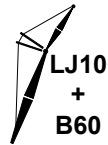

ft	75°				70°				65°				
	ft	°	ft	lb	ft	°	ft	lb	ft	°	ft	lb	
85													85
90													90
95													95
100													100
105													105
110													110
115													115
120													120
125													125
130													130
135													135
140													140
145													145
150													150
155													155
160													160
165	64.6	456.6	103,800	189,800									165
170	62.7	454.0	98,900	189,800									170
175	60.8	451.1	94,300	189,800									175
180	58.9	448.1	89,900	186,300									180
185	56.9	444.7	85,800	179,800									185
190	54.9	441.2	81,900	173,700									190
195	52.8	437.3	78,100	167,900									195
200	50.7	433.2	74,600	162,400									200
205	48.5	428.7	71,200	157,200	58.9	439.9	46,600	138,800					205
210	46.2	423.8	68,000	152,200	56.9	436.6	44,000	134,300					210
215	43.8	418.6	64,900	147,500	54.9	433.0	41,500	130,000					215
220	41.3	412.8	61,900	142,900	52.8	429.2	39,100	125,900					220
230	35.8	399.6	56,300	134,400	48.5	420.6	34,700	118,200					230
240	29.4	383.0	51,100	126,600	43.8	410.4	30,600	111,200	54.6	422.1	96,200		240
250	21.3	360.4	46,100	119,300	38.7	398.4	26,700	104,700	50.4	414.0	90,300		250
260	4.8	311.7	40,700	112,200	32.8	383.7	23,100	98,700	45.9	404.6	84,900		260
270					25.7	364.8		93,000	40.9	393.5	79,900		270
280					15.7	336.2		87,600	35.4	380.1	75,200		280
290									29.0	363.2	70,800		290
300									20.6	340.0	66,600		300

# MLC650 VPC-MAX S-2

ASME B30.5

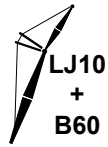

661,300 lb

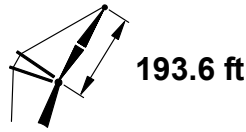
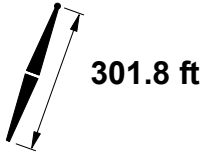

ft	85°				83°				80°				ft
	ft	lb	lb	lb	ft	lb	lb	lb	ft	lb	lb	lb	
90	74.7	496.7	172,600	172,600									90
95	73.1	495.1	172,300	172,300									95
100	71.6	493.4	171,700	171,700									100
105	70.0	491.5	170,800	170,800									105
110	68.4	489.5	169,700	169,700	71.7	492.4	173,000	173,000					110
115	66.8	487.3	168,400	168,400	70.1	490.5	172,800	172,800					115
120	65.1	484.9	166,900	166,900	68.5	488.5	172,200	172,200					120
125	63.5	482.4	165,300	165,300	66.9	486.3	171,400	171,400					125
130	61.8	479.6	163,300	163,300	65.3	483.9	170,400	170,400					130
135	60.1	476.7	161,500	161,500	63.6	481.4	169,300	169,300	68.7	486.2	171,900	171,900	135
140	58.3	473.6	158,700	158,700	61.9	478.7	167,800	167,800	67.1	484.1	167,500	171,900	140
145	56.5	470.2	153,800	153,800	60.2	475.8	166,600	166,600	65.5	481.8	159,400	171,900	145
150	54.7	466.6	148,900	148,900	58.5	472.7	164,800	164,800	63.8	479.2	151,800	171,600	150
155	52.8	462.8	144,100	144,100	56.7	469.3	163,200	163,200	62.2	476.5	144,700	171,000	155
160	50.9	458.7	139,400	139,400	54.9	465.8	158,500	160,700	60.4	473.7	138,100	170,300	160
165	49.0	454.3	134,900	134,900	53.0	461.9	151,600	155,900	58.7	470.6	131,900	169,400	165
170	46.9	449.5	130,600	130,600	51.1	457.9	145,200	151,100	56.9	467.3	126,000	168,500	170
175	44.8	444.5	126,500	126,500	49.2	453.5	139,000	146,500	55.1	463.7	120,500	167,300	175
180	42.6	439.0	122,500	122,500	47.1	448.8	133,300	141,900	53.3	459.9	115,300	166,200	180
185	40.3	433.1	118,900	118,900	45.0	443.8	127,800	137,600	51.4	455.9	110,300	165,000	185
190	37.9	426.6	115,500	115,500	42.8	438.3	122,600	133,400	49.4	451.6	105,700	163,100	190
195	35.3	419.5	112,400	112,400	40.6	432.4	117,700	129,500	47.4	446.9	101,200	158,500	195
200	32.6	411.8	109,700	109,700	38.1	426.0	113,000	125,700	45.3	441.9	97,000	154,100	200
205	29.6	403.0	107,400	107,400	35.6	419.1	108,500	122,300	43.1	436.5	92,900	149,600	205
210	26.3	393.1	105,500	105,500	32.9	411.3	104,200	119,200	40.8	430.7	89,100	145,400	210
215	22.6	381.4	104,200	104,200	29.9	402.7	100,100	116,500	38.5	424.4	85,400	141,400	215
220	18.0	366.8	103,900	103,900	26.7	392.9	96,200	114,200	35.9	417.5	81,900	137,500	220
230					18.5	367.2	88,600	111,700	30.3	401.3	75,200	130,800	230
240									23.5	380.5	69,000	125,700	240
250									13.4	348.0	63,000	123,800	250
260													260
270													270
280													280
290													290
300													300
310													310
320													320



# MLC650 VPC-MAX S-2

ASME B30.5

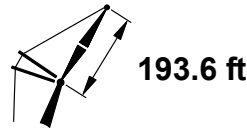
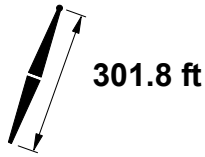
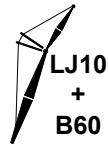

ft	75°				70°				65°			
	ft	lb	lb	lb	ft	lb	lb	lb	ft	lb	lb	ft
90												90
95												95
100												100
105												105
110												110
115												115
120												120
125												125
130												130
135												135
140												140
145												145
150												150
155												155
160												160
165												165
170												170
175	64.1	473.6	89,900	166,500								175
180	62.4	471.0	85,600	166,500								180
185	60.7	468.1	81,500	166,500								185
190	59.0	465.0	77,700	166,500								190
195	57.2	461.7	74,000	164,600								195
200	55.4	458.2	70,500	159,100								200
205	53.5	454.5	67,200	154,000								205
210	51.6	450.5	64,000	149,000								210
215	49.7	446.2	61,000	144,300	59.0	456.9	126,500					215
220	47.7	441.6	58,100	139,900	57.2	453.6	122,400					220
230	43.4	431.3	52,700	131,500	53.6	446.4	114,900					230
240	38.8	419.3	47,600	123,800	49.7	438.1	107,900					240
250	33.6	405.0	43,000	116,700	45.6	428.5	101,500					250
260	27.6	387.1	38,500	110,100	41.2	417.4	95,600	51.4	431.4	81,500		260
270	19.8	362.8	34,300	103,900	36.3	404.4	90,100	47.4	422.4	76,600		270
280					30.8	388.5	85,000	43.1	412.0	72,000		280
290					24.1	368.1	80,200	38.5	399.9	67,700		290
300					14.4	337.2	75,500	33.3	385.4	63,700		300
310								27.1	367.2	59,900		310
320								19.2	342.3	56,200		320

# MLC650 VPC-MAX S-2

ASME B30.5



661,300 lb

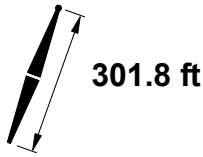

301.8 ft

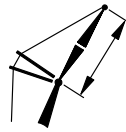

213.3 ft

ft	85°				83°				80°				ft
	ft	lb	lb	lb	ft	lb	lb	lb	ft	lb	lb	lb	
95	74.7	515.7	153,500	153,500									95
100	73.3	514.2	153,300	153,300									100
105	71.9	512.5	152,800	152,800									105
110	70.5	510.7	152,200	152,200									110
115	69.0	508.7	151,300	151,300	72.0	511.5	153,800	153,800					115
120	67.6	506.6	150,200	150,200	70.6	509.7	153,600	153,600					120
125	66.1	504.4	149,100	149,100	69.2	507.7	153,300	153,300					125
130	64.6	501.9	147,800	147,800	67.7	505.6	152,700	152,700					130
135	63.1	499.3	146,200	146,200	66.2	503.4	152,000	152,000					135
140	61.6	496.6	144,700	144,700	64.8	501.0	151,100	151,100	69.4	505.5	152,400	152,400	140
145	60.0	493.7	143,200	143,200	63.2	498.4	150,000	150,000	67.9	503.4	152,400	152,400	145
150	58.4	490.5	139,000	139,000	61.7	495.7	148,900	148,900	66.4	501.2	147,900	152,400	150
155	56.8	487.2	134,900	134,900	60.2	492.7	147,700	147,700	64.9	498.8	140,800	152,400	155
160	55.2	483.7	130,700	130,700	58.6	489.6	146,400	146,400	63.4	496.2	134,200	152,300	160
165	53.5	479.9	126,700	126,700	57.0	486.3	145,100	145,100	61.9	493.5	128,100	151,800	165
170	51.8	476.0	122,800	122,800	55.3	482.8	141,700	141,700	60.4	490.6	122,300	151,200	170
175	50.0	471.7	118,900	118,900	53.7	479.1	135,800	137,700	58.8	487.5	116,800	150,600	175
180	48.2	467.2	115,200	115,200	51.9	475.1	130,000	133,700	57.2	484.3	111,600	149,800	180
185	46.3	462.4	111,700	111,700	50.2	470.9	124,600	129,800	55.5	480.8	106,700	148,900	185
190	44.4	457.2	108,300	108,300	48.4	466.4	119,500	125,900	53.9	477.1	102,100	148,000	190
195	42.4	451.7	105,100	105,100	46.5	461.6	114,600	122,100	52.2	473.1	97,700	147,100	195
200	40.3	445.8	102,000	102,000	44.6	456.5	110,000	118,600	50.4	469.0	93,500	145,200	200
205	38.1	439.4	99,200	99,200	42.6	451.1	105,500	115,100	48.6	464.5	89,500	141,300	205
210	35.9	432.5	96,600	96,600	40.5	445.2	101,300	111,800	46.8	459.8	85,700	137,500	210
215	33.4	424.9	94,300	94,300	38.4	438.8	97,300	108,700	44.8	454.7	82,100	133,800	215
220	30.8	416.6	92,200	92,200	36.1	432.0	93,400	105,800	42.9	449.3	78,600	130,100	220
230	24.8	396.6	89,100	89,100	31.1	416.2	86,200	100,700	38.6	437.2	72,100	123,200	230
240	16.8	368.5	88,200	88,300	25.1	396.5	79,400	97,000	34.0	422.9	66,100	116,900	240
250					17.3	369.0	73,000	95,200	28.6	405.7	60,500	111,500	250
260									22.0	383.4	55,200	107,600	260
270									12.3	348.4	50,000	106,400	270
280													280
290													290
300													300
310													310
320													320
330													330
340													340

# MLC650 VPC-MAX S-2

ASME B30.5

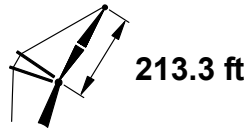
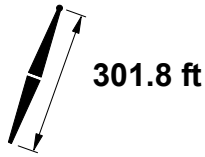
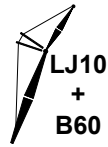

ft	75°				70°			65°			ft
	ft	lb	lb	lb	ft	lb	lb	ft	lb	lb	
95											95
100											100
105											105
110											110
115											115
120											120
125											125
130											130
135											135
140											140
145											145
150											150
155											155
160											160
165											165
170											170
175											175
180											180
185	63.6	490.6	77,300	147,400							185
190	62.1	487.9	73,500	147,400							190
195	60.6	485.0	69,900	147,400							195
200	59.0	482.0	66,400	147,400							200
205	57.4	478.7	63,200	147,400							205
210	55.8	475.3	60,000	145,800							210
215	54.1	471.6	57,100	141,200							215
220	52.4	467.7	54,200	136,700							220
230	48.9	459.2	48,900	128,400	57.4	470.6	111,400				230
240	45.1	449.4	44,000	120,800	54.1	463.5	104,600				240
250	41.1	438.3	39,400	113,800	50.7	455.4	98,300				250
260	36.7	425.4	35,200	107,400	47.0	446.3	92,500				260
270	31.8	410.0	31,200	101,300	43.2	436.0	87,100	52.2	448.6	73,200	270
280	26.0	390.9	27,400	95,700	39.0	424.0	82,000	48.6	440.0	68,700	280
290	18.5	364.9	23,700	90,400	34.4	410.0	77,300	44.9	430.2	64,500	290
300					29.1	393.0	72,900	40.8	419.0	60,600	300
310					22.6	371.2	68,700	36.4	405.9	56,900	310
320					13.3	338.0	64,600	31.4	390.3	53,400	320
330								25.6	370.9	50,100	330
340								17.9	344.2	46,800	340

# MLC650 VPC-MAX S-2

ASME B30.5

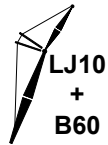

661,300 lb



360°

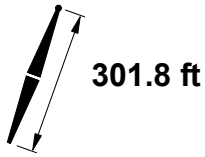

301.8 ft

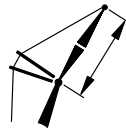

232.9 ft

ft	85°				83°				80°				ft
	ft	lb	lb	lb	ft	lb	lb	lb	ft	lb	lb	lb	
100	74.8	534.8	136,700	136,700									100
105	73.5	533.3	136,600	136,600									105
110	72.2	531.6	136,200	136,200									110
115	70.9	529.8	135,700	135,700									115
120	69.6	527.9	135,100	135,100	72.3	530.6	136,700	136,700					120
125	68.2	525.9	134,300	134,300	71.0	528.8	136,600	136,600					125
130	66.9	523.7	133,300	133,300	69.7	526.9	136,400	136,400					130
135	65.6	521.4	132,300	132,300	68.4	524.9	136,100	136,100					135
140	64.2	518.9	131,100	131,100	67.0	522.7	135,600	135,600					140
145	62.8	516.3	130,200	130,200	65.7	520.4	135,000	135,000	69.9	524.6	134,800	134,800	145
150	61.4	513.5	128,700	128,700	64.3	518.0	134,300	134,300	68.5	522.6	134,800	134,800	150
155	60.0	510.6	126,200	126,200	62.9	515.4	133,500	133,500	67.2	520.5	134,800	134,800	155
160	58.5	507.5	122,700	122,700	61.5	512.6	132,400	132,400	65.9	518.2	131,500	134,800	160
165	57.0	504.2	119,200	119,200	60.1	509.7	131,400	131,400	64.5	515.8	125,400	134,800	165
170	55.5	500.7	115,700	115,700	58.7	506.6	130,500	130,500	63.1	513.2	119,600	134,800	170
175	54.0	497.1	112,300	112,300	57.2	503.3	129,400	129,400	61.7	510.5	114,100	134,700	175
180	52.5	493.2	109,000	109,000	55.7	499.9	125,900	125,900	60.3	507.6	109,000	134,300	180
185	50.9	489.1	105,700	105,700	54.2	496.2	122,400	122,500	58.8	504.5	104,200	133,800	185
190	49.2	484.7	102,500	102,500	52.6	492.4	117,300	119,100	57.4	501.2	99,600	133,300	190
195	47.6	480.1	99,400	99,400	51.0	488.3	112,500	115,800	55.9	497.8	95,200	132,600	195
200	45.8	475.2	96,500	96,500	49.4	483.9	107,900	112,500	54.4	494.2	91,100	131,900	200
205	44.1	470.0	93,700	93,700	47.7	479.4	103,500	109,300	52.8	490.4	87,100	131,200	205
210	42.2	464.5	91,000	91,000	46.0	474.5	99,300	106,200	51.2	486.3	83,400	130,100	210
215	40.3	458.5	88,400	88,400	44.2	469.3	95,300	103,100	49.6	482.0	79,800	126,800	215
220	38.3	452.2	86,000	86,000	42.4	463.8	91,500	100,200	47.9	477.4	76,300	123,600	220
230	34.1	438.0	81,800	81,800	38.5	451.6	84,400	94,800	44.5	467.5	69,900	117,300	230
240	29.2	421.0	78,400	78,400	34.3	437.5	77,800	90,000	40.8	456.2	64,000	111,200	240
250	23.5	399.8	76,100	76,100	29.5	420.7	71,700	86,100	36.7	443.2	58,600	105,500	250
260	15.7	369.9	74,100	75,600	23.8	399.8	65,900	83,200	32.3	428.1	53,500	100,500	260
270					16.2	370.5	60,400	82,100	27.1	409.7	48,700	96,200	270
280									20.8	386.0	44,100	93,100	280
290									11.2	348.5	39,600	92,300	290
300													300
310													310
320													320
330													330
340													340
350													350
360													360

# MLC650 VPC-MAX S-2

ASME B30.5

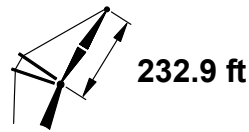
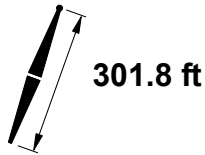
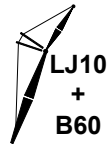

ft	75°				70°			65°			ft
	°	ft	lb	lb	°	ft	lb	°	ft	lb	
100											100
105											105
110											110
115											115
120											120
125											125
130											130
135											135
140											140
145											145
150											150
155											155
160											160
165											165
170											170
175											175
180											180
185											185
190	64.7	510.1	70,400	128,900							190
195	63.3	507.6	66,800	128,900							195
200	61.9	504.9	63,400	128,900							200
205	60.5	502.0	60,200	128,900							205
210	59.0	498.9	57,100	128,900							210
215	57.6	495.7	54,200	128,900							215
220	56.1	492.3	51,400	128,900							220
230	53.0	484.9	46,100	126,200							230
240	49.8	476.6	41,300	118,600	57.6	487.6	102,100				240
250	46.5	467.3	36,800	111,700	54.6	480.6	95,900				250
260	42.9	456.8	32,700	105,300	51.5	472.8	90,100				260
270	39.1	444.9	28,800	99,400	48.2	464.0	84,800				270
280	34.9	431.0	25,200	93,900	44.7	454.1	79,800	52.8	465.8	66,200	280
290	30.2	414.7	21,800	88,700	41.1	442.9	75,200	49.6	457.5	62,100	290
300	24.6	394.4		83,800	37.1	430.1	70,900	46.2	448.1	58,200	300
310	17.4	366.8		79,200	32.6	415.2	66,800	42.7	437.5	54,600	310
320					27.6	397.1	63,000	38.8	425.5	51,200	320
330					21.4	374.0	59,300	34.6	411.5	48,000	330
340					12.3	338.4	55,700	29.8	394.9	45,000	340
350								24.2	374.3	42,000	350
360								16.8	345.9	39,200	360

# MLC650 VPC-MAX S-2

ASME B30.5

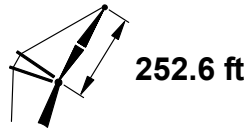
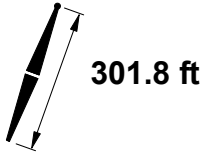
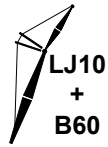

ft	85°				83°				80°				ft
	ft	lb	lb	lb	ft	lb	lb	lb	ft	lb	lb	lb	
105	74.8	553.8	121,100	121,100									105
110	73.6	552.3	121,000	121,000									110
115	72.4	550.7	120,700	120,700									115
120	71.2	549.0	120,400	120,400									120
125	70.0	547.1	119,900	119,900	72.6	549.6	120,900	120,900					125
130	68.8	545.1	119,200	119,200	71.4	547.9	120,900	120,900					130
135	67.6	543.0	118,400	118,400	70.1	546.1	120,800	120,800					135
140	66.3	540.8	117,700	117,700	68.9	544.1	120,500	120,500					140
145	65.1	538.4	116,700	116,700	67.7	542.0	120,200	120,200					145
150	63.8	535.9	116,000	116,000	66.5	539.8	119,700	119,700					150
155	62.5	533.3	114,700	114,700	65.2	537.4	119,100	119,100	69.1	541.9	119,100	119,100	155
160	61.2	530.5	113,400	113,400	63.9	535.0	118,600	118,600	67.9	539.8	119,100	119,100	160
165	59.9	527.6	110,500	110,500	62.7	532.3	117,900	117,900	66.6	537.6	119,100	119,100	165
170	58.6	524.5	107,500	107,500	61.4	529.6	117,200	117,200	65.4	535.2	115,500	119,100	170
175	57.2	521.2	104,600	104,600	60.1	526.6	116,200	116,200	64.1	532.8	110,100	119,100	175
180	55.9	517.8	101,700	101,700	58.7	523.6	115,400	115,400	62.8	530.2	105,000	119,100	180
185	54.5	514.2	98,800	98,800	57.4	520.3	113,900	113,900	61.5	527.4	100,200	118,900	185
190	53.0	510.4	95,900	95,900	56.0	516.9	111,000	111,000	60.2	524.5	95,600	118,600	190
195	51.6	506.4	93,200	93,200	54.6	513.3	108,200	108,200	58.9	521.5	91,300	118,200	195
200	50.1	502.1	90,400	90,400	53.2	509.5	104,300	105,300	57.5	518.2	87,200	117,800	200
205	48.6	497.7	87,800	87,800	51.7	505.5	100,000	102,400	56.2	514.8	83,300	117,300	205
210	47.0	493.0	85,200	85,200	50.2	501.3	95,800	99,600	54.8	511.3	79,500	116,800	210
215	45.4	488.0	82,700	82,700	48.7	496.9	91,900	96,900	53.4	507.5	76,000	116,200	215
220	43.8	482.8	80,400	80,400	47.2	492.2	88,100	94,200	51.9	503.6	72,600	115,600	220
230	40.3	471.3	76,000	76,000	43.9	482.1	81,000	89,100	48.9	495.0	66,200	110,100	230
240	36.6	458.2	72,100	72,100	40.5	470.7	74,500	84,300	45.8	485.4	60,400	104,700	240
250	32.5	443.2	68,800	68,800	36.8	457.7	68,500	80,000	42.5	474.8	55,000	99,500	250
260	27.8	425.2	66,200	66,200	32.7	442.7	62,900	76,200	38.9	462.7	50,000	94,500	260
270	22.3	402.8	64,600	64,600	28.1	425.0	57,700	73,100	35.1	448.9	45,400	89,900	270
280	14.7	371.1	60,500	64,300	22.6	402.9	52,800	70,900	30.8	432.9	41,000	85,900	280
290					15.2	371.8	48,000	70,300	25.8	413.5	36,900	82,500	290
300									19.7	388.4	32,900	80,200	300
310									10.3	348.3	28,900	79,700	310
320													320
330													330
340													340
350													350
360													360
370													370
380													380

# MLC650 VPC-MAX S-2

ASME B30.5

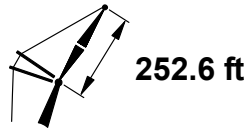
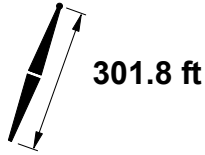

ft	75°				70°				65°				ft
	°	ft	lb	lb	°	ft	lb	lb	°	ft	lb	lb	
105													105
110													110
115													115
120													120
125													125
130													130
135													135
140													140
145													145
150													150
155													155
160													160
165													165
170													170
175													175
180													180
185													185
190													190
195													195
200	64.3	527.1	59,000	113,300									200
205	63.0	524.6	55,800	113,300									205
210	61.7	521.8	52,800	113,300									210
215	60.4	518.9	49,900	113,300									215
220	59.1	515.9	47,100	113,300									220
230	56.4	509.3	41,900	113,300									230
240	53.6	502.1	37,200	113,300									240
250	50.6	494.0	32,800	108,500	57.8	504.6	92,400						250
260	47.6	485.0	28,700	102,200	55.0	497.7	86,700						260
270	44.4	475.0	25,000	96,300	52.1	490.0	81,400						270
280	41.0	463.8	21,400	90,900	49.2	481.5	76,500						280
290	37.3	451.0		85,800	46.0	472.0	72,000	53.4	483.0	58,600			290
300	33.3	436.4		81,000	42.7	461.5	67,700	50.4	474.9	54,800			300
310	28.7	419.1		76,500	39.2	449.5	63,700	47.4	465.8	51,300			310
320	23.4	397.7		72,300	35.4	435.9	60,000	44.2	455.8	47,900			320
330	16.4	368.4		68,200	31.1	420.0	56,400	40.7	444.4	44,800			330
340					26.2	401.0	53,000	37.1	431.6	41,800			340
350					20.2	376.5	49,800	33.0	416.8	39,000			350
360					11.3	338.6	46,600	28.4	399.2	36,300			360
370								23.0	377.5	33,700			370
380								15.8	347.4	31,100			380

# MLC650 VPC-MAX S-2

ASME B30.5

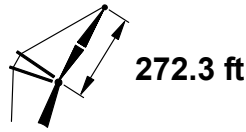
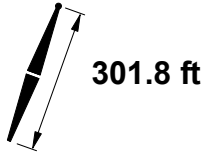

ft	85°				83°				80°				ft
	ft	lb	lb	lb	ft	lb	lb	lb	ft	lb	lb	lb	
110	74.9	572.9	107,900	107,900									110
115	73.8	571.4	107,700	107,700									115
120	72.7	569.8	107,500	107,500									120
125	71.5	568.1	107,200	107,200									125
130	70.4	566.3	106,600	106,600	72.8	568.7	107,600	107,600					130
135	69.3	564.3	106,200	106,200	71.6	567.0	107,600	107,600					135
140	68.2	562.3	105,600	105,600	70.5	565.2	107,500	107,500					140
145	67.0	560.1	104,900	104,900	69.4	563.3	107,200	107,200					145
150	65.9	557.8	104,100	104,100	68.3	561.3	107,000	107,000					150
155	64.7	555.4	103,300	103,300	67.1	559.1	106,600	106,600					155
160	63.5	552.9	102,500	102,500	66.0	556.9	106,200	106,200	69.5	561.0	105,700	105,700	160
165	62.3	550.3	101,600	101,600	64.8	554.5	105,700	105,700	68.4	559.0	105,700	105,700	165
170	61.1	547.5	99,600	99,600	63.6	552.0	105,000	105,000	67.3	556.9	105,700	105,700	170
175	59.9	544.5	97,000	97,000	62.4	549.3	104,400	104,400	66.1	554.6	105,700	105,700	175
180	58.7	541.4	94,600	94,600	61.2	546.5	103,700	103,700	64.9	552.3	102,200	105,700	180
185	57.4	538.2	92,100	92,100	60.0	543.6	103,000	103,000	63.8	549.8	97,400	105,700	185
190	56.1	534.8	89,700	89,700	58.8	540.5	102,300	102,300	62.6	547.1	92,900	105,700	190
195	54.8	531.2	87,200	87,200	57.5	537.3	100,600	100,600	61.4	544.4	88,600	105,500	195
200	53.5	527.5	84,800	84,800	56.3	533.9	98,200	98,200	60.2	541.5	84,500	105,200	200
205	52.2	523.6	82,400	82,400	55.0	530.4	95,700	95,700	58.9	538.4	80,700	104,900	205
210	50.8	519.5	80,100	80,100	53.7	526.7	93,300	93,300	57.7	535.2	77,000	104,500	210
215	49.4	515.2	77,800	77,800	52.3	522.8	89,600	90,900	56.4	531.9	73,500	104,100	215
220	48.0	510.6	75,600	75,600	51.0	518.7	85,900	88,600	55.1	528.3	70,100	103,600	220
230	45.1	500.8	71,400	71,400	48.2	509.9	78,900	83,900	52.5	520.8	63,800	102,500	230
240	42.0	490.0	67,500	67,500	45.2	500.1	72,500	79,500	49.8	512.4	58,100	98,300	240
250	38.6	477.8	64,100	64,100	42.1	489.3	66,500	75,300	46.9	503.2	52,700	93,700	250
260	35.1	464.0	61,000	61,000	38.8	477.2	61,000	71,400	43.9	493.0	47,800	89,200	260
270	31.1	448.1	58,400	58,400	35.2	463.5	55,900	68,000	40.7	481.7	43,200	84,900	270
280	26.6	429.2	56,400	56,400	31.3	447.7	51,100	65,000	37.3	468.9	39,000	80,900	280
290	21.2	405.6	54,400	55,300	26.8	429.0	46,600	62,600	33.6	454.4	35,000	77,200	290
300	13.9	372.1	49,700	55,100	21.5	405.7	42,400	60,900	29.4	437.4	31,200	73,900	300
310					14.3	372.9	38,200	60,600	24.7	417.0	27,600	71,200	310
320									18.7	390.6	24,100	69,500	320
330									9.5	347.8	20,600	69,200	330
340													340
350													350
360													360
370													370
380													380
390													390
400													400



# MLC650 VPC-MAX S-2

ASME B30.5

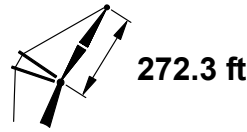
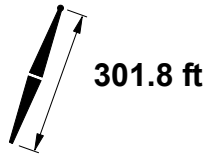
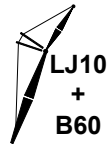

ft	75°				70°				65°				ft
	ft	ft	lb	lb	ft	ft	lb	lb	ft	ft	lb	lb	
110													110
115													115
120													120
125													125
130													130
135													135
140													140
145													145
150													150
155													155
160													160
165													165
170													170
175													175
180													180
185													185
190													190
195													195
200													200
205													205
210	63.9	544.1	49,700	100,600									210
215	62.8	541.5	46,900	100,600									215
220	61.5	538.8	44,200	100,600									220
230	59.1	532.9	39,100	100,600									230
240	56.6	526.4	34,400	100,600									240
250	54.0	519.2	30,100	100,600									250
260	51.3	511.3	26,100	100,000	57.9	521.5	84,300						260
270	48.5	502.6	22,400	94,200	55.3	514.7	79,100						270
280	45.6	493.0		88,800	52.7	507.2	74,200						280
290	42.5	482.3		83,800	50.0	498.9	69,700						290
300	39.3	470.4		79,100	47.1	489.8	65,500	53.8	500.1	52,400			300
310	35.7	456.9		74,700	44.1	479.7	61,600	51.1	492.2	48,900			310
320	31.9	441.4		70,500	41.0	468.4	57,900	48.3	483.4	45,600			320
330	27.5	423.2		66,600	37.6	455.8	54,400	45.4	473.8	42,500			330
340	22.3	400.7		62,900	33.9	441.4	51,100	42.3	463.0	39,600			340
350	15.5	369.8		59,300	29.8	424.7	48,000	39.0	451.0	36,800			350
360					25.1	404.6	45,000	35.5	437.4	34,200			360
370					19.2	378.8	42,100	31.6	421.8	31,700			370
380					10.5	338.5	39,300	27.2	403.3	29,000			380
390								21.9	380.4	26,400			390
400								14.9	348.6	23,700			400

# MLC650 VPC-MAX S-2

ASME B30.5

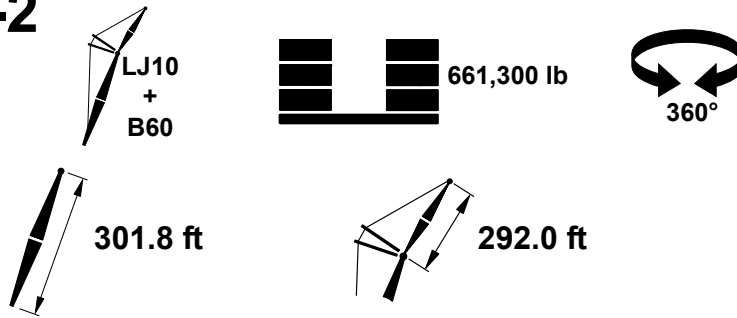

ft	85°			83°			80°			ft
	ft	°	lb	ft	°	lb	ft	°	lb	
115	74.9	591.9	92,600							115
120	73.9	590.4	92,500							120
125	72.8	588.9	92,300							125
130	71.8	587.2	92,000							130
135	70.8	585.4	91,800	72.9	587.8	92,100				135
140	69.7	583.5	91,400	71.9	586.1	92,100				140
145	68.6	581.5	90,800	70.9	584.4	92,100				145
150	67.6	579.4	90,300	69.8	582.5	91,900				150
155	66.5	577.2	89,800	68.8	580.5	91,700				155
160	65.4	574.9	89,200	67.7	578.4	91,500				160
165	64.3	572.5	88,600	66.6	576.2	91,100	69.9	580.2	90,100	165
170	63.2	569.9	87,900	65.5	573.9	90,700	68.9	578.3	90,100	170
175	62.1	567.2	87,200	64.4	571.5	90,300	67.8	576.2	90,100	175
180	61.0	564.4	86,500	63.3	568.9	89,800	66.8	574.0	90,100	180
185	59.9	561.5	84,600	62.2	566.3	89,300	65.7	571.7	90,100	185
190	58.7	558.4	82,600	61.1	563.5	88,800	64.6	569.3	90,100	190
195	57.5	555.2	80,600	60.0	560.5	88,200	63.5	566.8	90,100	195
200	56.4	551.8	78,500	58.8	557.5	87,700	62.4	564.1	90,100	200
205	55.2	548.3	76,600	57.7	554.3	87,100	61.3	561.3	89,900	205
210	53.9	544.6	74,500	56.5	550.9	86,100	60.1	558.4	89,700	210
215	52.7	540.8	72,600	55.3	547.4	84,100	59.0	555.4	89,400	215
220	51.4	536.8	70,700	54.1	543.8	82,200	57.8	552.2	89,100	220
230	48.9	528.2	66,900	51.6	535.9	78,300	55.4	545.4	88,400	230
240	46.2	518.7	63,300	49.0	527.4	74,400	53.0	537.9	87,700	240
250	43.3	508.3	60,000	46.3	518.0	70,700	50.5	529.8	86,900	250
260	40.3	496.8	56,900	43.5	507.6	67,100	47.8	520.9	83,300	260
270	37.1	483.9	54,000	40.5	496.2	63,800	45.1	511.1	79,600	270
280	33.7	469.4	51,600	37.3	483.4	60,700	42.2	500.3	76,000	280
290	29.9	452.7	49,500	33.9	468.9	57,900	39.1	488.3	72,600	290
300	25.5	432.9	47,900	30.1	452.3	55,500	35.8	474.8	69,400	300
310	20.3	408.2	47,000	25.7	432.7	53,600	32.2	459.5	66,400	310
320	13.1	372.8	47,000	20.6	408.3	52,300	28.2	441.7	63,800	320
330				13.5	373.8	52,100	23.6	420.3	61,600	330
340							17.8	392.6	60,300	340
350							8.7	347.0	60,100	350
360										360
370										370
380										380
390										390
400										400

# MLC650 VPC-MAX S-2

ASME B30.5

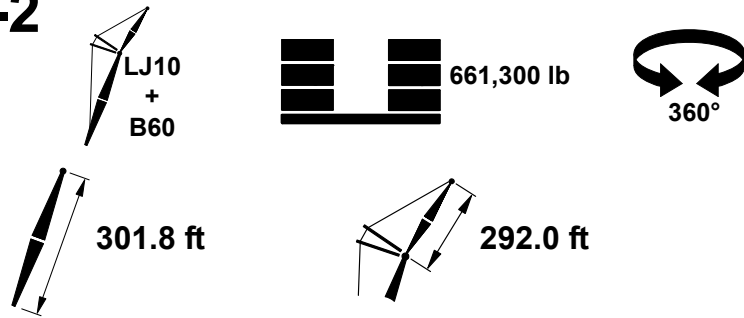

ft	75°			70°			65°			ft
	ft	lb	ft	ft	lb	ft	ft	lb		
115										115
120										120
125										125
130										130
135										135
140										140
145										145
150										150
155										155
160										160
165										165
170										170
175										175
180										180
185										185
190										190
195										195
200										200
205										205
210										210
215	64.7	563.6	84,800							215
220	63.6	561.1	84,800							220
230	61.4	555.7	84,800							230
240	59.1	549.8	84,800							240
250	56.8	543.4	84,800							250
260	54.4	536.3	84,800							260
270	51.9	528.5	84,800	58.0	538.5	75,500				270
280	49.3	520.1	84,800	55.6	531.7	70,700				280
290	46.7	510.8	80,500	53.2	524.4	66,200				290
300	43.9	500.6	75,900	50.7	516.3	62,100				300
310	40.9	489.3	71,500	48.0	507.4	58,200	54.2	517.2	45,300	310
320	37.7	476.7	67,400	45.3	497.7	54,500	51.7	509.5	42,000	320
330	34.3	462.5	63,600	42.4	487.0	51,100	49.2	500.9	39,000	330
340	30.6	446.2	59,900	39.4	475.0	47,800	46.5	491.6	36,000	340
350	26.3	427.1	56,500	36.1	461.7	44,800	43.7	481.3	32,900	350
360	21.3	403.5	53,100	32.5	446.6	41,900	40.7	469.9	30,000	360
370	14.6	371.0	50,000	28.6	429.0	39,100	37.5	457.2	27,200	370
380				24.0	408.0	36,400	34.1	442.9	24,500	380
390				18.3	380.9	33,800	30.3	426.5	21,900	390
400				9.7	338.1	31,300				400

# MLC650 VPC-MAX S-2

ASME B30.5

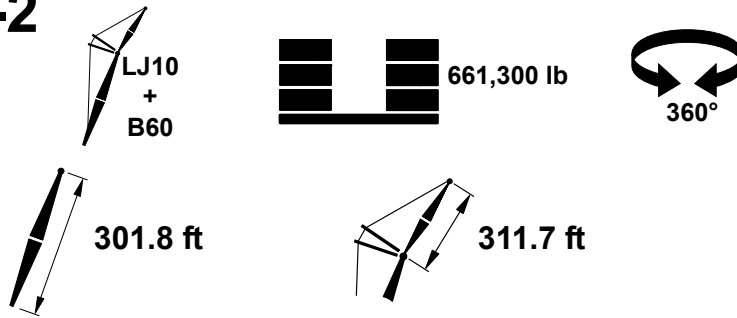

ft	85°			83°			80°			ft
	ft	lb	ft	ft	lb	ft	ft	lb		
120	74.9	611.0	81,900						120	
125	73.9	609.5	81,800						125	
130	73.0	607.9	81,500						130	
135	72.0	606.3	81,100						135	
140	71.0	604.5	80,800						140	
145	70.1	602.7	80,500	72.1	605.2	81,100			145	
150	69.1	600.7	80,100	71.1	603.5	81,000			150	
155	68.1	598.7	79,600	70.2	601.6	80,800			155	
160	67.1	596.5	79,200	69.2	599.7	80,600			160	
165	66.1	594.3	78,700	68.2	597.7	80,400			165	
170	65.1	591.9	78,100	67.2	595.5	80,100			170	
175	64.0	589.5	77,600	66.2	593.3	79,800	69.3	597.4	79,100	175
180	63.0	586.9	77,000	65.2	590.9	79,500	68.3	595.4	79,100	180
185	62.0	584.2	76,400	64.1	588.5	79,100	67.3	593.3	79,100	185
190	60.9	581.4	75,600	63.1	585.9	78,700	66.3	591.1	79,100	190
195	59.8	578.4	74,000	62.1	583.2	78,200	65.3	588.7	79,100	195
200	58.8	575.4	72,200	61.0	580.4	77,800	64.3	586.3	79,100	200
205	57.7	572.2	70,500	59.9	577.5	77,300	63.2	583.7	78,900	205
210	56.6	568.8	68,800	58.9	574.4	76,800	62.2	581.1	78,800	210
215	55.4	565.3	67,100	57.8	571.3	76,300	61.1	578.3	78,600	215
220	54.3	561.7	65,400	56.7	567.9	75,700	60.1	575.4	78,400	220
230	52.0	554.0	62,100	54.4	560.9	72,400	57.9	569.2	77,900	230
240	49.6	545.6	58,800	52.1	553.2	69,000	55.7	562.4	77,300	240
250	47.1	536.4	55,700	49.7	544.8	65,800	53.4	555.1	76,700	250
260	44.5	526.4	52,800	47.2	535.7	62,600	51.1	547.1	76,000	260
270	41.8	515.5	50,100	44.6	525.7	59,500	48.6	538.4	74,000	270
280	38.9	503.3	47,500	41.9	514.8	56,500	46.1	528.9	70,800	280
290	35.8	489.8	45,200	39.0	502.7	53,800	43.4	518.6	67,700	290
300	32.4	474.6	43,300	35.9	489.3	51,300	40.7	507.2	64,700	300
310	28.7	457.1	41,600	32.6	474.2	49,000	37.7	494.5	61,900	310
320	24.5	436.4	40,400	28.9	456.8	47,100	34.5	480.4	59,200	320
330	19.4	410.5	39,800	24.7	436.3	45,500	31.0	464.4	56,800	330
340	12.3	373.3	39,800	19.7	410.8	44,600	27.2	445.8	54,700	340
350				12.8	374.5	44,500	22.7	423.4	53,000	350
360							17.0	394.4	52,000	360
370							7.9	345.9	51,900	370
380										380
390										390
400										400
410										410
420										420

# MLC650 VPC-MAX S-2

ASME B30.5

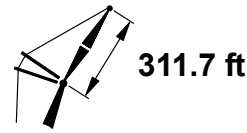
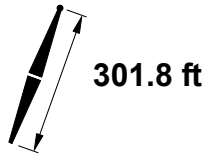
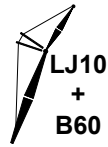

ft	75°			70°			ft
	ft	lb	ft	ft	lb	ft	
120							120
125							125
130							130
135							135
140							140
145							145
150							150
155							155
160							160
165							165
170							170
175							175
180							180
185							185
190							190
195							195
200							200
205							205
210							210
215							215
220							220
230	63.4	578.1	74,000				230
240	61.3	572.7	74,000				240
250	59.2	566.8	74,000				250
260	57.0	560.3	74,000				260
270	54.7	553.4	74,000				270
280	52.4	545.8	74,000	58.1	555.5	68,300	280
290	50.0	537.5	74,000	55.9	548.8	63,900	290
300	47.6	528.5	73,900	53.6	541.5	59,800	300
310	45.0	518.6	69,500	51.2	533.6	56,000	310
320	42.3	507.8	65,500	48.8	524.9	52,400	320
330	39.4	495.9	61,700	46.3	515.5	49,000	330
340	36.4	482.7	58,100	43.7	505.2	45,800	340
350	33.1	467.8	54,700	40.9	493.9	42,700	350
360	29.4	450.8	51,400	37.9	481.4	39,900	360
370	25.3	430.8	48,400	34.8	467.4	37,100	370
380	20.4	406.1	45,400	31.3	451.5	34,500	380
390	13.9	372.0	42,500	27.5	433.2	32,100	390
400				23.0	411.2	29,700	400
410				17.5	382.9	27,100	410
420				9.0	337.5	24,400	420