

Potain MCI 85 A/B

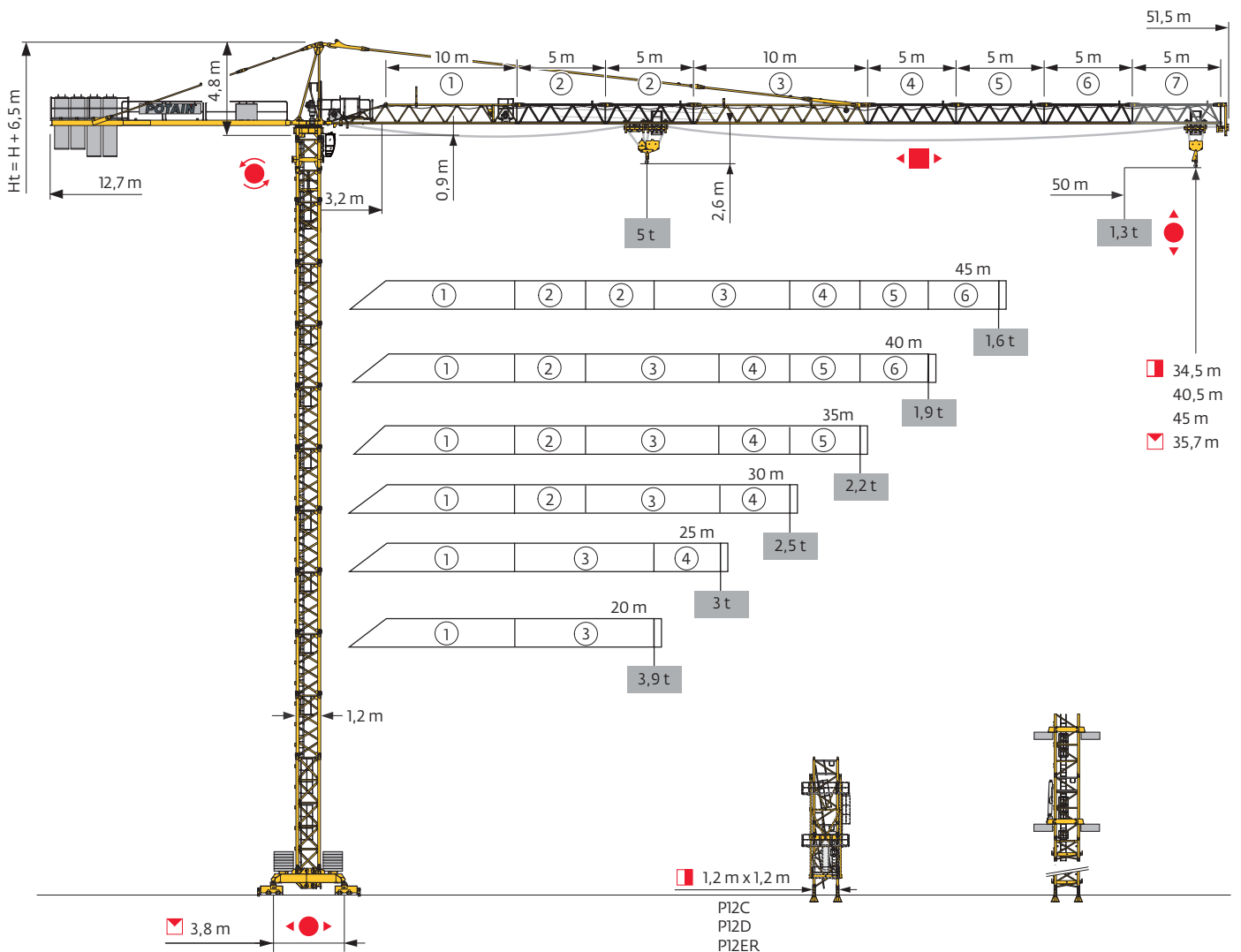

Mât - Réactions / Mast - Reaktionskräfte / Mast - Reactions / Mástil - Reacciones / Torre - Reazioni
 Tramo - Reações / Реакция опор мачты

1,2 m

20 m → 50 m

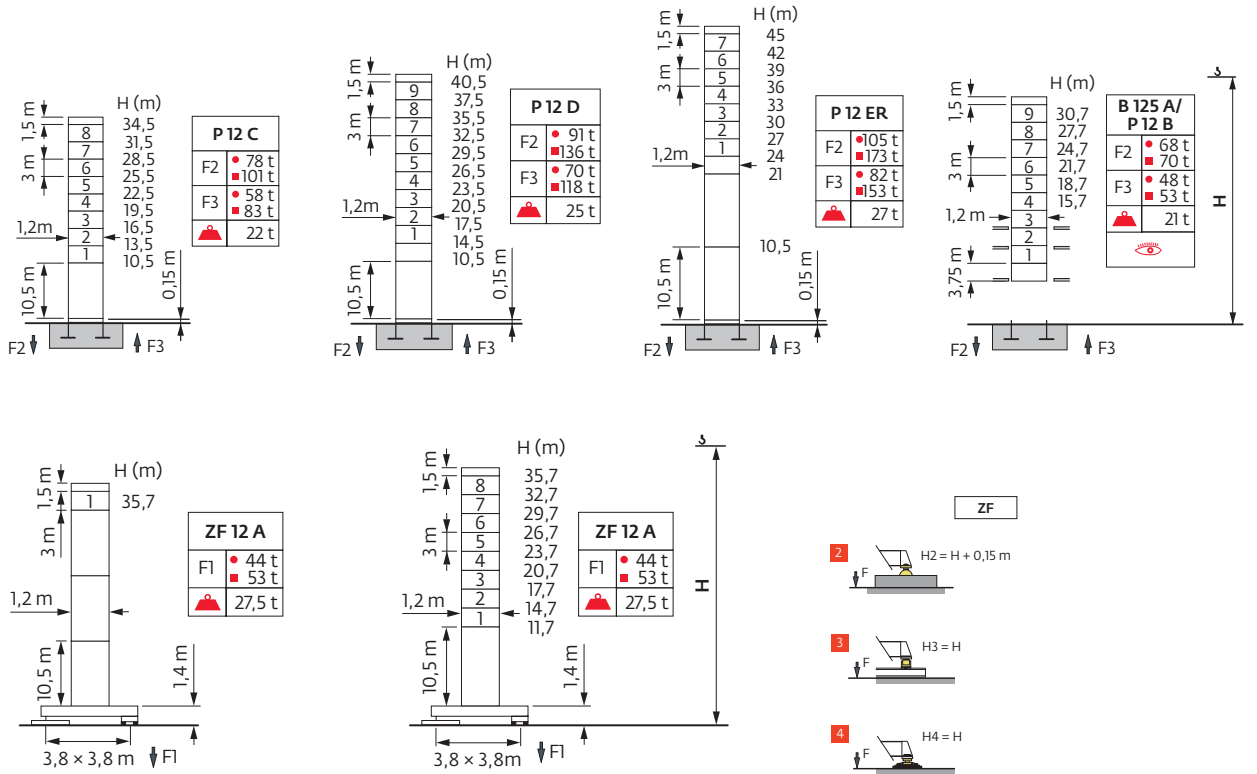

Télescopage sur dalles / Kletterkrane im Gebäude / Climbing Crane / Telescopage grua trepadora / Gru in cavedio
 Telescopagem sobre lajes / Кран, ползущий внутри здания

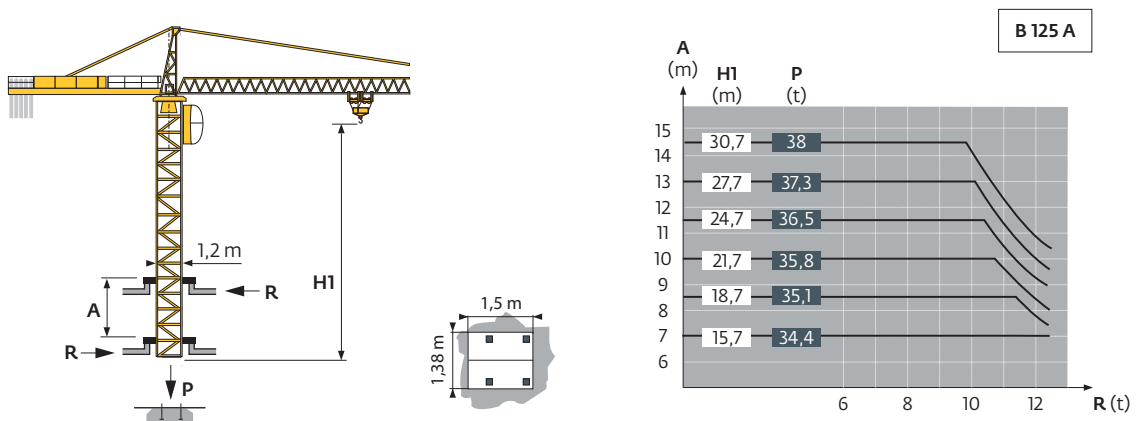

Ancrages / Verankerungen / Anchorages / Anclajes / Ancoraggi
 Ancoragem / Анкера

P 12C

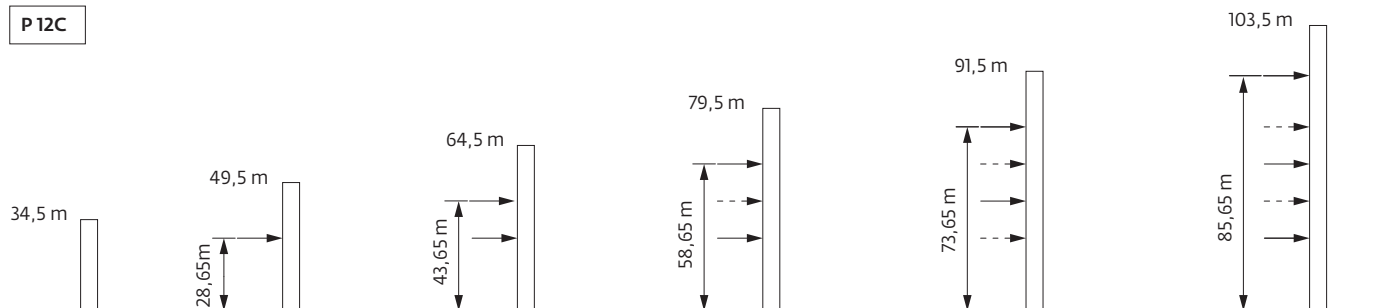

i H > 103,5m



Courbes de charges / Lastkurven / Load curves / Curvas de cargas / Curve di carico
 Curvas de carga / Кривые нагрузок



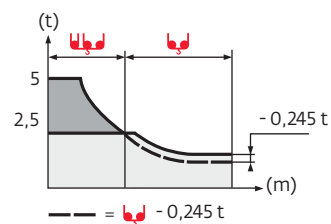

50 m	3,2	▶	15	17	20	22	25	26,7	28,9	30	32	35	37	40	42	45	47	50	m
	5	4,3	3,6	3,2	2,7	2,5	2,5	2,4	2,2	2	1,9	1,7	1,6	1,5	1,4	1,3			t
								2,5	2,4	2,2	2	1,9	1,7	1,6	1,5	1,4	1,3		t
45 m	3,2	▶	16	17	20	22	25	27	28,4	30,8	32	35	37	40	42	45			m
	5	4,6	3,8	3,4	2,9	2,65	2,5	2,5	2,4	2,2	2	1,85	1,75	1,6					t
									2,5	2,4	2,2	2	1,85	1,75	1,6				t
40 m	3,2	▶	16,4	17	20	22	25	27	29,1	31,6	32	35	37	40					m
	5	4,8	3,9	3,5	3	2,75	2,5	2,5	2,45	2,2	2,1	1,9							t
									2,5	2,45	2,2	2,1	1,9						t
35 m	3,2	▶	16,4	17	20	22	25	27	29,1	31,6	32	35							m
	5	4,8	3,9	3,5	3	2,75	2,5	2,5	2,45	2,2									t
									2,5	2,45	2,2								t
30 m	3,2	▶	16,3	17	20	22	25	27	30										m
	5	4,8	3,9	3,5	3	2,75	2,4												t
							2,5												t
25 m	3,2	▶	16,3	17	20	22	25												m
	5	4,8	3,9	3,5	3														t
							2,5												t
20 m	3,2	▶	16,3	17	20														m
	5	4,8	3,9																t
					2,5														t



Lest de base / Grundballast / Base ballast / Lastre de base / Zavorra di base
 Lastro da base / Базовый Балласт

 1,2 m	ZF 12 A	H (m)	35,7	34,2	32,7	31,2	29,7	28,2	26,7	25,2	23,7	22,2	20,7	19,2	17,7	16,2	14,7	13,2	11,7
		 (t)	45	45	45	45	40	40	40	40	40	40	35	35	35	35	35	35	35

Lest de contre-flèche / Gegenauslegerballast / Counter-jib ballast / Lastre de contra-flecha / Zavorra di controbraccio
 Lastro da contra lança / Противовес стрелы

	3400 kg	2950 kg	2250 kg	 (kg)
50 m	2	2	0	12 700
45 m	2	2	0	12 700
40 m	1	1	2	10 850
35 m	2	1	0	9 750
30 m	2	0	1	9 050
25 m	0	1	2	7 450
20 m	2	0	0	6 800

CG - 3400 kg

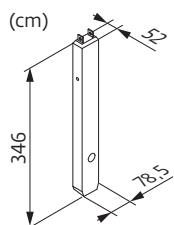

CP - 2950 kg

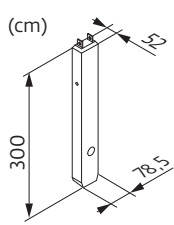

CM - 2250 kg

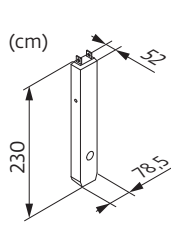













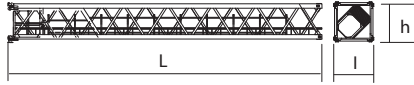

Encombremet et poids / Abmessungen und Gewicht / Dimensions and weight / Dimensiones y peso / Ingombro e peso
 dimensões e pesos / габаритные размеры и вес

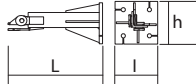
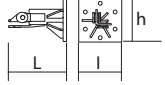
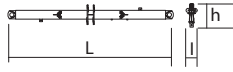
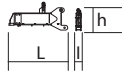

Partie tournante / Drehender Kranteil / Slewing crane part / Parte giratoria
 Parte rotante / Parte rotativa / Поворотная часть : 50 m - 25 PC 13 / 40 LVF 13











Partie tournante / Drehender Kranteil / Slewing crane part Parte giratoria / Parte rotante / Parte rotativa Поворотная часть	L (m)	l (m)	h (m)	kg (+/- 5%)		
Contre-flèche / Gegenausleger Counter-jib / Contra-flecha Controbraccio / Contra-lança Контр-стрела		11,83	1,25	1,45	1825	
Porte-flèche / Auslegerträger Cathead / Porta-flecha Cuspide / Suporte de lança Оголовок		4,83	1,55	1,78	2640	
Cabine / Kabine Cab / Cabina Cabina / Cabina Кабина	Smartview	1,68	1,18	2,31	385	
Élément de flèche / Auslegerelement Jib section / Elemento de flecha Elemento di braccio / Elemento de lança Секция стрелы		① 25 PC 13 40 LVF 13	10,2 10,2	1,81 1,81	1,68 1,52	1315 1505
Élément de flèche / Auslegerelement Jib section / Elemento de flecha Elemento di braccio / Elemento de lança Секция стрелы		③	10,2	0,8	1,09	1080
Élément de flèche / Auslegerelement Jib section / Elemento de flecha Elemento di braccio / Elemento de lança Секция стрелы		② ④ ⑤ ⑥ ⑦	5,23 5,23 5,18 5,18 5,18	0,8 0,8 0,8 0,8 0,8	1,07 1,07 1,05 1,05 1,05	520 520 375 375 255
Chariot / Laufkatze Trolley / Carrello Carro / Carro-distribuidor Тележка			1,24	1,01	0,71	185
Chariot / Laufkatze Trolley / Carrello Carro / Carro-distribuidor Тележка			1,14	1,01	0,71	175
Chariot / Laufkatze Trolley / Carrello Carro / Carro-distribuidor Тележка			1,14	1,01	0,71	175
Moufle / Hubflasche Pulley block / Aparejo Bozzello / Cadernal Полиспаст			1,09	0,2	1,38	280
Moufle / Hubflasche Pulley block / Aparejo Bozzello / Cadernal Полиспаст			0,74	0,14	1,17	150

Equipement de télescage / Teleskopierüstung / Telescoping equipment Equipo de telescopaje / Equipaggiamento di telescopaggio / Equipamento de telescopagem Оборудование для телескопирования						
Cage de télescage / Teleskopwagen Telescopic cage / Jaula de telescopaje Gabbia di telescopaggio / Gaiola de telescopagem для телескопирования крана		 1,2 m	6,3	3,61	3,63	1980
Mâture / Mastwerk / Masts Mástil / Torre / Coluna Мачты						
S 24D1 S 24D2		 1,2 m  1,2 m	3,2 3,2	1,29 1,29	1,26 1,26	750 780
S 24 BS S 26 BS SR 28 ER		 1,2 m  1,2 m  1,2 m	10,7 10,7 10,7	1,3 1,3 1,3	1,28 1,27 1,3	2250 3070 4060
Bases / Kranbasen / Crane bases Bases / Basi / Bases Фундамент под кран						
Pieds de scellement / VerankerungsfüÙe Fixing angles / Pie de empotramiento Montante da annegare / Angulos fixadores анкера		P 12C	1,1	0,5	0,5	170
		R 12C	0,68	0,5	0,5	145
Bras de croix / Fundamentkruzträger Cross girder / Brazo en cruz Braccio croce / Braço da cruz Поперечная балка		ZF 12A	5,64	0,67	1,4	1540
1/2 Bras de croix / 1/2 Fundamentkruzträger 1/2 Cross girder / 1/2 Brazo en cruz 1/2 Braccio croce / 1/2 Braço da cruz 1/2 Поперечная балка		ZF 12A	2,98 2,98	0,4 0,43	1,41 1,41	895 925

400 V - 50 Hz													hp	kW	
	25 PC 13 (GH)	m/min	9	35,5	71			4,4	17,7	35,4			25	18,5	360 m
		t	2,5	2,5	1,3			5	5	2,6					
	25 PC 13	m/min	6,6	33	66			3,3	16,5	33			25	18,5	323 m
		t	2,5	2,5	1,3			5	5	2,6					
	40 LVF 13 (GH)	m/min	5	13	41	61	81,5	2,45	6,5	20,4	30,6	40,8	40	30	360 m
		t	2,5	2,5	2,5	1,9	1,25	5	5	5	3,75	2,5			
	4 D3 V3	m/min	15 → 30 → 58									4	3		
	RCV 60	rpm	0 → 0,8									8	5,8		
ZF 	TVD 324 C1	m/min	12,5 → 25									2 x 7	2 x 5,2		

CEI 38  IEC 38	
400 V (+10% -10%) 50 Hz	25 PC 13 : 30 kVA 40 LVF 13 : 42 kVA

480 V - 60 Hz													hp	kW	
	25 PC 13 (GH)	m/min	10,5	42,5	85			5,3	21,2	42,5			30	22,1	360 m
		t	2,5	2,5	1,3			5	5	2,6					
	25 PC 13	m/min	7,9	39,6	79,2			3,9	19,8	39,6			30	22,1	323 m
		t	2,5	2,5	1,3			5	5	2,5					
	40 LVF 13 (GH)	m/min	5	13	41	61	81,5	2,45	6,5	20,4	30,6	40,8	40	30	360 m
		t	2,5	2,5	2,5	1,9	1,25	5	5	5	3,75	2,5			
	4 D3 V3	m/min	18 → 39 → 70									4,8	3,6		
	RCV 60	rpm	0 → 0,96									9,6	7		
ZF 	TVD 324 C1	m/min	15 → 30									2 x 8,4	2 x 6,2		

CEI 38  IEC 38	
480 V (+6% -10%) 60 Hz	25 PC 13 : 36 kVA 40 LVF 13 : 50 kVA

	FR	DE	EN	ES	IT	PT	RU
	Appel de flèche	Auslegerüberhöhung	Jib elevation	Elevación de la flecha	Inclinazione braccio	Desvio da lança	подъем стрелы
	Réactions en service	Reaktionskräfte in Betrieb	Reactions in service	Reacciones en servicio	Reazioni in servizio	Reacções em serviço	Реакция при работе
	Réactions hors service	Reaktionskräfte außer Betrieb	Reactions out of service	Reacciones fuera de servicio	Reazioni fuori servizio	Reacções fora de serviço	Реакция в покое
	A vide sans lest avec flèche et hauteur maximum	Gewicht ohne Last, ohne Ballast, mit Ausleger und max. Höhe	Weight without load, without ballast, with jib and max. height	Peso en vacío sin lastre, con flecha y altura máxima	Peso a vuoto, senza zavorra, con braccio e altezza massimi.	Peso em vazio sem lastro com lança e altura máxima.	Вес пустого, без балласта, со стрелой, максимальной высоты.
	Poids total du lest	Ballast-Gesamtgewicht	Total ballast weight	Peso total del lastre	Peso totale della zavorra	Peso total do lastro	Общий вес балласта
	Camion 13.4 m	Lkw 13.4 m	Lorry 13.4 m	Camión 13.4 m	Camion 13.4 m	Camião 13.4 m	Ррузовой автомобиль 13.4 м
	Conteneur High Cube 40"	Container High Cube 40"	Container High Cube 40"	Contenedor High cube 40"	Container High Cube 40"	Contentor 40"	Контейнер повышенной вместимости длиной 40"
	Cadre d'ancrage serré	Fester Verankerungsrahmen	Tightened anchorage frame	Marco de anclaje de apriete	Quadro di ancoraggio stretto	Quadro de amarração apertado	Прикрепленная анкерная рама
	Cadre d'ancrage desserré	Looser Verankerungsrahmen	Loosened anchorage frame	Marco de anclaje de desapriete	Quadro di ancoraggio allentato	Quadro de amarração solto	Отсоединенная анкерная рама
	Levage	Heben	Hoisting	Elevación	Sollevarmento	Elevação	Подъем
	Distribution	Katzfahren	Trolleying	Distribución	Distribuzione	Distribuição	Перемещение по стреле
	Orientation	Schwenken	Slewing	Orientación	Rotazione	Rotação	Поворот
	Translation	Kranfahren	Travelling	Traslación	Traslazione	Translação	Перемещение крана
	Puissance nominale	Nennleistung	Rated power	Potencia nominal	Potenza nominale	Potência nominal	Номинальная мощность
	Voir télescopage sur dalles	Siehe Kletterkrane im Gebäude	See climbing crane	Vea grua trepadora	Consultare gru in cavedio	Ver telescopagem sobre lages	См. кран, ползущий внутри здания
	Nous consulter	Auf Anfrage	Consult us	Consultarnos	Consultateci	Consultar-nos	Проконсультируйтесь у нас
	Document commercial non contractuel. Pour toute information technique se référer à la notice correspondante.	Unverbindliches Vertriebsdokument. Für technische Informationen, siehe die entsprechenden Anweisungen.	This commercial document is not legally binding. For any technical information, please refer to the corresponding instructions.	Documento comercial no contractual. Para cualquier información técnica, ver la noticia correspondiente.	Documento commerciale non vincolante, per tutte le informazioni tecniche fare riferimento al catalogo istruzioni.	Documento comercial não contractual. Para qualquer informação técnica complementar consultar as respectivas instruções.	Этот коммерческий документ не является юридически обязательным. Для получения технической информации, см. соответствующие инструкции.

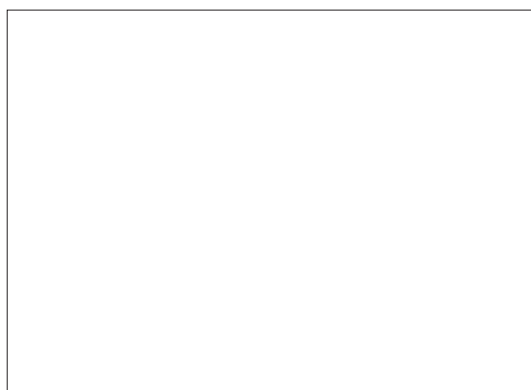

www.manitowoc.com

Americas
Manitowoc, Wisconsin, USA
 Tel: +1 920 684 6621
 Fax: +1 920 683 6277

Shady Grove, Pennsylvania, USA
 Tel: +1 717 597 8121
 Fax: +1 717 597 4062

Europe, Middle East, Africa
Ecully, France
 Tel: +33 (0)4 72 18 20 20
 Fax: +33 (0)4 72 18 20 00

China
Shanghai, China
 Tel: +86 21 6457 0066
 Fax: +86 21 6457 4955

Greater Asia-Pacific
Singapore
 Tel: +65 6264 1188
 Fax: +65 6862 4040