

Potain Plus

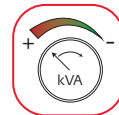

Power Control



Top Tracing 3

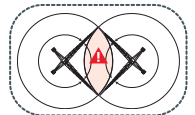

Mât - Réactions / Mast - Reaktionskräfte / Mast - Reactions / Mástil - Reacciones / Torre - Reazioni
Tramo - Reacções / Реакция опор мачты

2 m - P 63A - C50						
ΔΔΔΔ (m)	30	35	40	45	50	55
(m)	57,5	54,2	52,5	49,2	47,5	44,2
/P _r (m)	57,5	54,2	52,5	49,2	47,5	44,2
3,33 m	0	2	0	2	0	2
5 m	9	7	8	6	7	5
10 m	1	1	1	1	1	1
F2 (t)	● 174	172	173	174	170	168
	■ 372	366	375	368	376	369
F3 (t)	● 135	133	128	129	132	130
	■ 334	328	337	331	339	332
(m) D50	47,5	45,9	42,5	40,9	37,5	35,9
/P _r (m) D50	47,5	45,9	42,5	40,9	37,5	35,9

2 m - V 60A - - C50						
ΔΔΔΔ (m)	30	35	40	45	50	55
(m)	43,5	40,1	36,8	33,5	30,1	28,5
/P _r (m)	43,5	40,1	36,8	33,5	30,1	28,5
3,33 m	2	1	0	2	1	2
5 m	6	6	6	4	4	3
F1 (t)	● 93	93	93	93	87	90
	■ 118	114	110	108	104	109
(m) D50	33,5	31,8	28,5	25,1	21,8	20,1
/P _r (m) D50	33,5	31,8	28,5	25,1	21,8	20,1

2 m - ZX 640 - - C50						
ΔΔΔΔ (m)	30	35	40	45	50	55
(m)	55,2	51,8	48,5	45,2	43,5	40,2
/P _r (m)	55,2	51,8	48,5	45,2	43,5	40,2
3,33 m	2	1	0	2	0	2
5 m	7	7	7	5	6	4
10 m	1	1	1	1	1	1
F1 (t)	● 124	124	124	122	122	120
	■ 180	175	170	167	172	168
(m) D50	45,2	41,8	38,5	35,2	33,5	30,2
/P _r (m) D50	45,2	41,8	38,5	35,2	33,5	30,2

i Autres compositions de pylône - Nous consulter. / Andere Turmaufbauten - bitte kontaktieren Sie uns. / Other mast compositions - Please consult us. / Para otras composiciones de mástil - Por favor contáctenos. / Per altre composizioni torre, contattateci. / Para outras composições de coluna - Por favor, consulte-nos. / Для других композиций мачты пожалуйста консультируйтесь с нами.

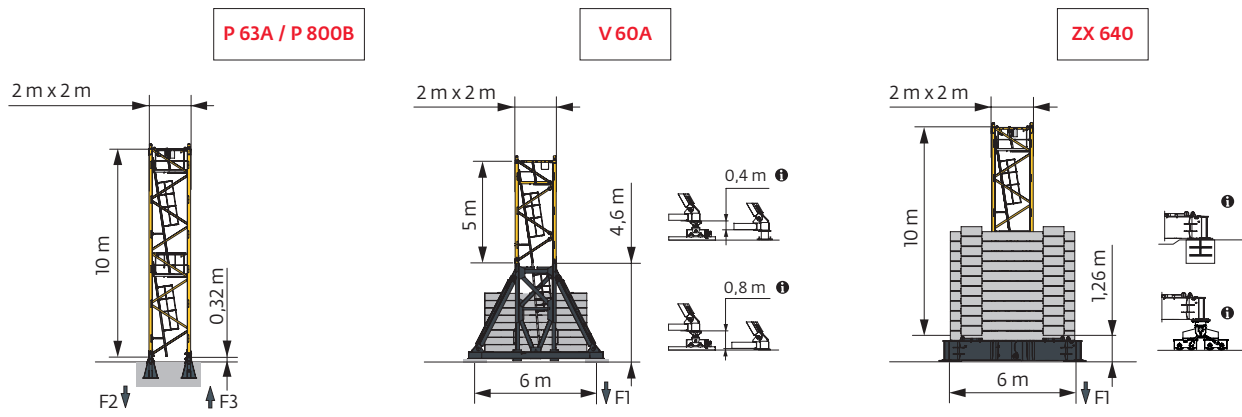

Accès motorisés : compositions de mât, de lest de base et réactions adaptées. / Motorisierter Zugang vom : Mastzusammensetzung, Grundballast und Reaktionskräfte sind angepasst. / Motorized accesses: adapted mast composition, base ballast and reactions. / Accesso a cabina con elevador: Adaptación de composición de mástil, lastre de base y reacciones. / Accessi motorizzati: composizioni elementi torre, zavorre di base e reazioni aggiornate. / Acessos motorizados: composições de coluna, lastro da base e reacções adaptadas. / Лифты : адаптированная композиция мачты, базовый балласт и нагрузки.





Ancrages / Verankerungen / Anchorages / Anclajes / Ancoraggi
 Ancoragem / нкре



Lest de base / Grundballast / Base ballast / Lastre de base / Zavorra di base
 Lastro da base / Базовый Балласт

 (t) /  2 m - V 60A -  - C50

h (m)	30	35	40	45	50	55
43,5	132					
40,1	108	132				
36,8	108	108	132			
33,5	96	108	108	132		
30,1	84	96	96	108	120	
28,5	84	96	96	108	108	132
23,5	72	84	84	96	96	108
18,5	72	72	72	84	84	96

 (t) /  2 m - ZX 640 -  - C50

h (m)	30	35	40	45	50	55
55,2	220					
51,8	190	220				
48,5	160	190	220			
45,2	140	160	190	210		
43,5	120	150	170	200	220	
40,2	100	120	150	170	200	220
35,2	80	80	110	130	150	180
30,2	70	70	80	90	110	140
25,2	60	60	70	70	80	100
20,2	50	50	60	60	70	80

Courbes de charges / Lastkurven / Load curves / Curvas de cargas / Curve di carico
 Curvas de carga / Кривые нагрузок









h (m)	17	20	22	25	27	30	30,3	32	35	35,2	37	40	40,2	42	45	45,1	47	50	m			
50	14 t		7 t																			
	4 → 25,2	31,8 - 33		10	10	10	10	9,1	7,7	-	7	6,3	-	5,8	5	-	4,6	4	-	3,6	3,2	t
	4 → 25,5	32,5 - 34		10	10	10	10	9,3	8	-	7,2	6,7	-	6,1	5,3	-	4,8	4,2	-	3,8	3,3	t P+
45	3,7 → 20		32,3 - 33,1		14	14	12,4	10,3	9,2	7,9	-	7,1	6,5	-	5,9	5,2	-	4,7	4,1	4,1	t	
	3,7 → 20		33 - 34,2		14	14	12,4	10,5	9,4	8,1	-	7,3	6,8	-	6,2	5,4	-	4,9	4,3	4,3	t P+	
40	3,3 → 20,1		32,6 - 34		14	14	12,5	10,5	9,4	8	-	7,2	6,7	-	6,1	5,3	5,3	t				
	3,3 → 20,1		33,4 - 35		14	14	12,6	10,6	9,6	8,3	-	7,5	7	-	6,4	5,6	5,6	t P+				
35	3 → 20,3		33,2 - 34,2		14	14	12,7	10,6	9,5	8,2	-	7,4	6,8	6,8	t							
	3 → 20,3		33,9 - 35,2		14	14	12,7	10,8	9,7	8,4	-	7,7	7	7	t P+							
30	2,6 → 20,2				14	14	12,7	10,7	9,6	8,2	8,1	t										
	2,6 → 20,3				14	14	12,7	10,8	9,7	8,5	8,3	t P+										

 -  - 0,47 t max.



h (m)	17	20	22	25	27	30	30,3	32	35	35,2	37	40	40,2	42	45	45,1	47	50	52	55	m		
55	7 t																						
	4,4 → 31,7		7	7	7	7	7	7	-	6,9	6	-	5,5	4,8	-	4,4	3,9	-	3,6	3,2	2,9	2,55	t
	4,4 → 32,7		7	7	7	7	7	7	-	7	6,3	-	5,8	5,1	-	4,7	4,1	-	3,8	3,3	3	2,7	t P+
50	4 → 33,4		7	7	7	7	7	7	-	7	6,6	-	6	5,2	-	4,8	4,2	-	3,9	3,4	t		
	4 → 34,5		7	7	7	7	7	7	-	7	6,9	-	6,3	5,5	-	5	4,4	-	4,1	3,6	t P+		
45	3,7 → 34		7	7	7	7	7	7	-	7	6,7	-	6,1	5,4	-	5	4,4	4,3	t				
	3,7 → 35		7	7	7	7	7	7	-	7	7	-	6,4	5,7	-	5,2	4,6	4,6	t P+				
40	3,3 → 34,5		7	7	7	7	7	7	-	7	6,9	-	6,3	5,6	5,5	t							
	3,3 → 35,7		7	7	7	7	7	7	-	7	7	-	6,7	5,9	5,8	t P+							
35	3 → 35,2		7	7	7	7	7	7	-	7	7	7	t										
	3 → 35,2		7	7	7	7	7	7	-	7	7	7	t P+										
30	2,6 → 30,3		7	7	7	7	7	7	7	t													
	2,6 → 30,3		7	7	7	7	7	7	7	t P+													

Poids de flèche & lest de contre-flèche / Auslegergewicht & Gegenauslegerballast / Jib weight & counter-jib ballast / Peso de flecha y lastre de contra-flecha / Peso del braccio & zavorra di contro-braccio / Peso da lança & lastro da contra lança
 Вес стрелы и балласт контр-стрелы

	 (kg) (+/- 5%)	
		4190 kg 
55 m	6650 	4 16760
50 m	6535	4 16760
45 m	6140	4 16760
40 m	5500	4 16760
35 m	4860	4 16760
30 m	4300	4 16760

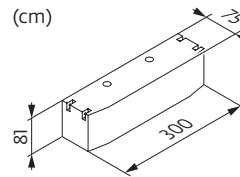

CAA - 4190 kg

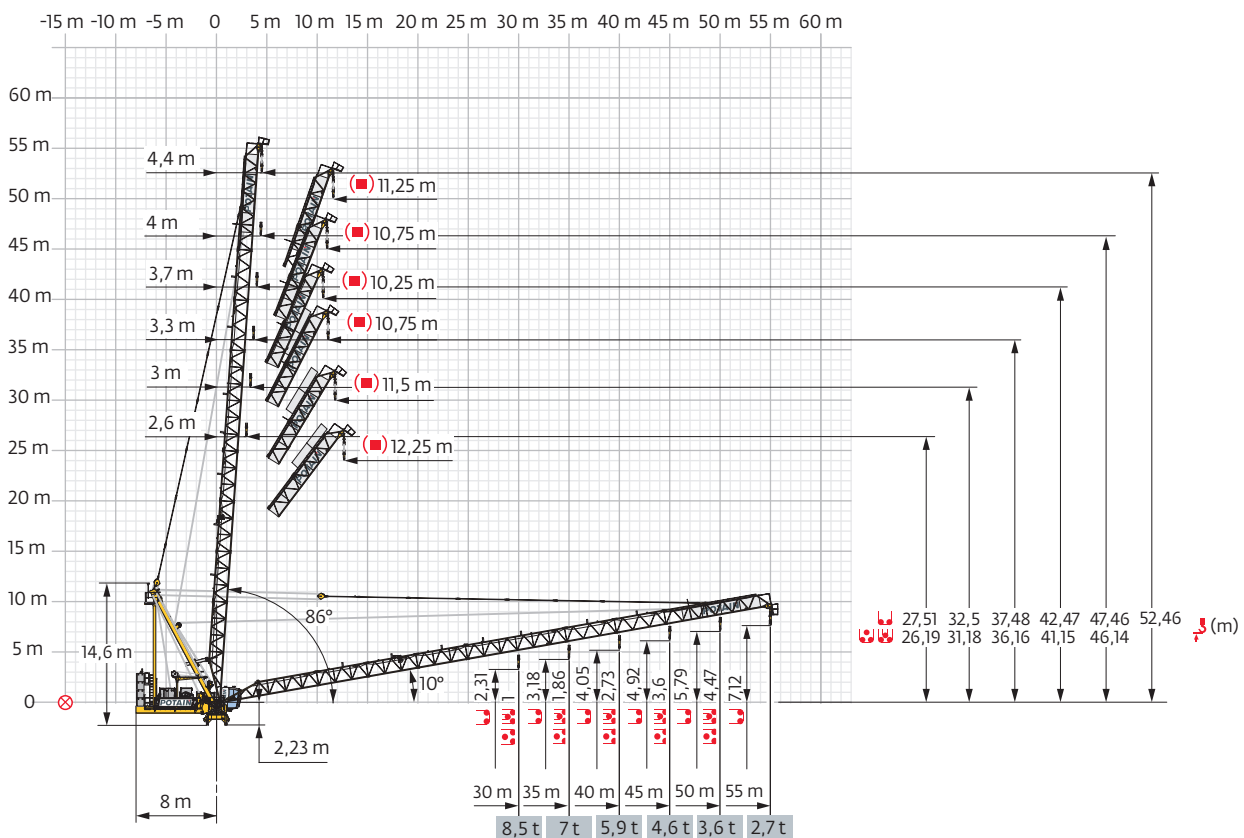

Flèche relevée / Ausleger in Steilstellung / Luffing jib / Flecha izada / Braccio impennato
 Lança inclinada / Маховая стрела





Encombremet et poids / Abmessungen und Gewicht / Dimensions and weight / Dimensiones y peso / Ingombro e peso
dimensões e pesos / габаритные размеры и вес

Partie tournante / Drehender Kranteil / Slewing crane part / Parte giratoria
Parte rotante / Parte rotativa / Поворотная часть :  55 m -  75 HPL™

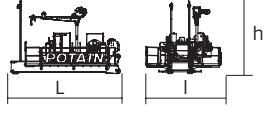
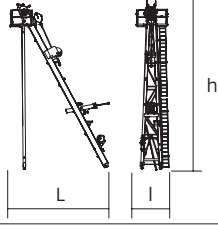
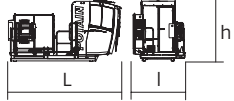
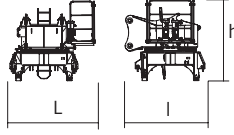
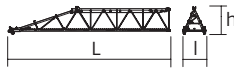
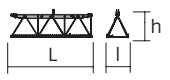
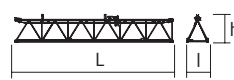
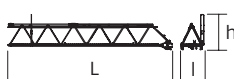
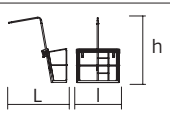
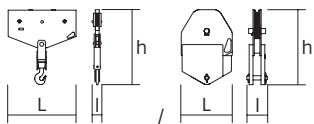
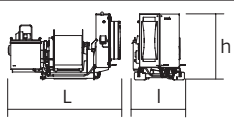
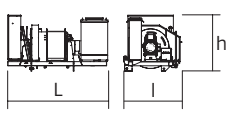

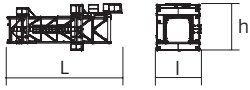
Partie tournante / Drehender Kranteil / Slewing crane part Parte giratoria / Parte rotante / Parte rotativa Поворотная часть		L (m)	l (m)	h (m)	kg (+/- 5%)	
Contre-flèche / Gegenausleger Counter-jib / Contra-flecha Controbraccio / Contra-lança Контр-стрела		75 HPL™ 110 HPL™	6,69 6,69	4,61 4,61	4,4 4,4	11800 14200
Poinçon / Auslegerhaltebock Strut / Puntal Puntone / Extrator стойка			6,95	2,52	11,75	4475
Cabine / Kabine Cab / Cabina Cabina / Cabina Кабина		Ultra View	4,6	2,14	2,53	1940
Pivot / Krankopf Towerhead / Pivote Portaralla / Pivot Секция поворотной части		□ 2 m	3,08	2,85	2,77	7350
Elément de flèche / Auslegerement Jib section / Elemento de flecha Elemento di braccio / Elemento de lança Секция стрелы		①	10,31	1,45	1,69	980
Elément de flèche / Auslegerement Jib section / Elemento de flecha Elemento di braccio / Elemento de lança Секция стрелы		② ④	5,15 5,15	1,38 1,39	1,76 1,75	510 380
Elément de flèche / Auslegerement Jib section / Elemento de flecha Elemento di braccio / Elemento de lança Секция стрелы		③	10,15	1,38	1,76	800
Elément de flèche / Auslegerement Jib section / Elemento de flecha Elemento di braccio / Elemento de lança Секция стрелы		⑤	10,63	1,5	2,28	1010
Nacelle de pointe de flèche / Inspektionsplattform für Auslegerspitze / Jib nose inspection platform / Plataforma de inspección a la punta de flecha / Piattaforma d'ispe- zione punta braccio / Plataforma de inspeção à ponta da lança / Платформа для осмотра на конце стрелы			1,91	1,42	2,12	55
Moufle / Hubflasche Pulley block / Aparejo Bozzello / Cadernal Полиспаст			1,31 0,6	0,22 0,24	1,58 0,88	285 230
Treuil de levage (+ câble) / Hubwerk (+ Seil) Hoisting winch (+ rope) / Mecanismo de elevación (+ cabo) Argano di sollevamento (+ fune) Guincho de elevação (+ cabo) Подъемная лебедка (+ канатом)		75 HPL™ 110 HPL™	2,82 3,64	1,32 1,7	1,71 1,93	2955 5235
Treuil de relevage (+ câble) / Auslegerverstellwerk (+ Seil) Luffing winch (+ rope) / Mecanismo de izado (+ cabo) Argano di Impennaggio braccio (+ fune) Mecanismo de Inclinação da Lança (+ cabo) лебедка подъема стрелы (+ канатом)		75 VVF	2,8	1,63	1,63	2865

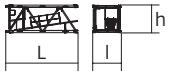
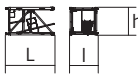
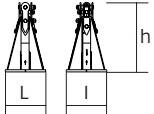
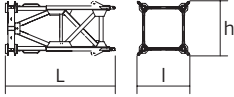
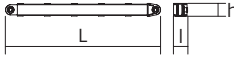
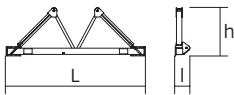
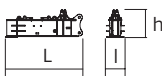
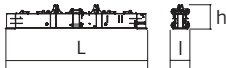
Рулоне / Kranturm / Crane tower Mástil / Torre / Torre Башня крана		L (m)	l (m)	h (m)	kg (+/- 5%)	
T 61		10,83	4,14	4,47	9700	
K 649B KMT 649E KRM 6410B		10,23 10,29 10,23	2,07 2,03 2,1	2,03 2,03 2,08	5290 4850 7100	
K 649A KMT 649A KR 649A KRMT 649A		5,23 5,23 5,23 5,23	2,07 2,07 2,1 2,1	2,03 2,03 2,08 2,08	2805 2570 3250 3050	
K 649C KMT 649C KRMT 649C		3,57 3,57 3,57	2,07 2,07 2,1	2,03 2,03 2,08	1985 2060 2450	
Pieds de scellement / Verankerungsfüße Fixing angles / Pie de empotramiento Montante da annegare / Angulos fixadores анкера		P 63A / P 800B	0,75	0,75	1,28	465
Mât-châssis / Grundmasteinheit Basic mast unit / Tramo-chasis Elemento base / Tramo-chassis Мачта для крепления к шасси		V 60A	5,01	2,41	2,41	4760
Haubans / Mastabstützungen Struts / Tornapuntas Puntoni / Escoras Растяжка		V 60A	4,51	0,29	0,29	470
Sommier / Unterwagenhälfte Half-bearer / Testero Testata / Estrutura base Траверса		V 60A	6,7	0,7	2,31	1840
1/2 Bras de croix / 1/2 Fundamentkruzträger 1/2 Cross girder / 1/2 Braço en cruz 1/2 Braccio croce / 1/2 Braço da cruz 1/2 Поперечная балка		ZX 640	4,35	1	1,56	3320
Bras de croix / Fundamentkruzträger Cross girder / Braço en cruz / Braccio croce / Braço da cruz Поперечная балка		ZX 640	9,15	1,19	1,56	6880

Mécanismes / Triebwerke / Mechanisms / Mecanismos / Meccanismi
 Mecanismos / Механизмы

400 V - 50 Hz													ch - PS hp	kW	
	75 HPL™ 35	m/min	41	53,5	78,5	136,5	198,5	20	26,5	38,5	68,5	99	75	55	754 m
		t	7	5,25	3,5	1,75	0,5	14	10,5	7	3,5	1,2			
	110 HPL™ 35	m/min	61	78,5	110,5	143,5	207	30,5	39,5	55,5	72	103,5	110	82	1308 m
		t	7	5,25	3,5	1,75	0,2	14	10,5	7	3,5	0,7			
	75 VVF 30		2 min									75	55		
	RVF 162 Optima+	tr/min U/min rpm	0 → 0,7									2 x 7,5	2 x 5,5		

	IEC 60204-32		kVA	
	400 V (+10% -10%) 50 Hz		75 HPL™ + 75 VVF : 134 → 74 kVA 110 HPL™ + 75 VVF : 162 → 88 kVA	

	FR	DE	EN	ES	IT	PT	RU
	Profil de vent suivant EN 14439 C50-D50	Windbedingungen gemäss EN 14439 C50-D50	Wind conditions according to EN 14439 C50-D50	Conformidad de los condiciones de viento EN 14439 C50-D50	Condizioni del vento secondo EN 14439 C50-D50	Perfil de vento conforme EN 14439 C50-D50	Ветровой режим в соответствии с EN 14439 C50-D50
	Équipements standards	Standardausrüstungen	Standard equipment	Equipamiento de serie	Equipaggiamento standard	Equipamento de série	Стандартное оборудование
	Équipements optionnels	Sonderausrüstungen	Options	Equipamiento opcional	Equipaggiamento in opzione	Equipamento opcional	Дополнительное оборудование (опция)
	Fonction Potain Plus : Courbes de charges Plus	Funktion Potain Plus: Plus-Lastkurven	Potain Plus function: Plus load curves	Función Potain Plus: Diagrama de cargas Plus	Funzione Potain Plus: Curve di carico Plus	Função Potain Plus: Diagrama de cargas Plus	Функция контроля мощности Potain Plus. Диаграммы грузоподъемности Plus
	Hauteurs sous crochet associées aux courbes de charges Plus	Hakenhöhen mit Plus-Lastkurven	Hook heights with Plus load curves	Altura bajo gancho, usando el diagrama de cargas Plus	Altezze sotto gancio con curve di carico Plus	Altura livre, utilizando o diagrama de cargas Plus	Высота под крюком для диаграмм грузоподъемности Plus
	Réactions en service	Reaktionskräfte in Betrieb	Reactions in service	Reacciones en servicio	Reazioni in servizio	Reacções em serviço	Реакция при работе
	Réactions hors service	Reaktionskräfte außer Betrieb	Reactions out of service	Reacciones fuera de servicio	Reazioni fuori servizio	Reacções fora de serviço	Реакция в покое
	Poids de flèche	Auslegergewicht	Jib weight	Peso de flecha	Peso del braccio	Peso da lança	вес стрелы
	Poids total du lest	Ballast-Gesamtgewicht	Total ballast weight	Peso total del lastre	Peso totale della zavorra	Peso total do lastro	Общий вес балласта
	Axe articulation flèche	Auslegergelenk-achse	Jib articulation axis	Eje de articulación de la flecha	Perno di articolazione del braccio	Eixo de articulação da lança	Ось шарнира стрелы
	Position girouette	Windfreistellung	Weathervanning position	Posición veleta	Libera rotazione	Posição em cata-vento	Флюгер
	Camion 13,4 m	Lkw 13,4 m	Lorry 13,4 m	Camión 13,4 m	Camion 13,4 m	Camião 13,4 m	Ррузовой автомобиль 13,4 м
	Conteneur High Cube 40', et/ou Flat Rack 20'	Container High Cube 40', and/oder Flat Rack 20'	Container High Cube 40', and/or Flat Rack 20'	Contenedor High Cube 40', y/o Flat Rack 20'	Container High Cube 40', e/o Flat Rack 20'	Contentor High Cube 40', e/ou Flat Rack 20'	40-футовый контейнер повышенной вместимости High Cube, и/или 20-футовая открытая платформа Flat Rack
	Levage	Heben	Hoisting	Elevación	Sollevaramento	Elevação	Подъем
	Relevage	AL-Verstellen	Luffing	Izado	Brandeggio	Levantamento	Маховый подъем
	Orientation	Schwenken	Slewing	Orientación	Rotazione	Rotação	Поворот
	Translation	Kranfahren	Travelling	Traslación	Traslazione	Translação	Перемещение крана
	Puissance requise	Erforderliche Leistung	Required power	Potencia Necesaria	Potenza richiesta	Potência Necessária	Потребляемая мощность
	Fonction Power Control : vitesses treuils adaptés à la puissance disponible	Funktion Power Control: Geschwindigkeiten der Triebwerke werden an die verfügbare Leistung angepasst	Power Control Function: winch speeds adapted to the available power	Función Power Control: marchas de los cabrestantes adaptadas a la potencia disponible	Funzione Power Control: velocità degli argani adattate alla potenza disponibile	Função Power Control: velocidades de guincho adaptadas à potência disponível	Функция контроля мощности Power Control: регулировка скорости лебедок в зависимости от доступной мощности
	Nous consulter	Auf Anfrage	Consult us	Consultarnos	Consultateci	Consultar-nos	Проконсультируйтесь у нас
	Document commercial non contractuel. Pour toute information technique se référer à la notice correspondante.	Unverbindliches Vertriebsdokument. Für technische Informationen, siehe die entsprechenden Anweisungen.	This commercial document is not legally binding. For any technical information, please refer to the corresponding instructions.	Documento comercial no contractual. Para cualquier información técnica, ver la noticia correspondiente.	Documento commerciale non vincolante, per tutte le informazioni tecniche fare riferimento al catalogo istruzioni.	Documento comercial não contractual. Para qualquer informação técnica complementar consultar as respectivas instruções.	Этот коммерческий документ не является юридически обязательным. Для получения технической информации, см. соответствующие инструкции.

