

## Quick Reference Catalogue

*Tower parts*

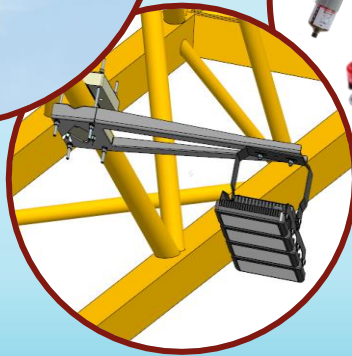





## Summary

|  |           |
|--|-----------|
| <b>POTAIN AT A GLANCE .....</b>              | <b>6</b>  |
| HISTORY .....                                | 8         |
| MANITOWOC DIRECT .....                       | 9         |
| WHY CHOOSE THE GENUINE PART?.....            | 11        |
| <b>CONSUMABLES .....</b>                     | <b>14</b> |
| GREASES FOR MAINTENANCE.....                 | 16        |
| OILS FOR MAINTENANCE .....                   | 17        |
| HYDRAULICS OIL FOR MAINTENANCE .....         | 18        |
| PAINTS FOR MAINTENANCE .....                 | 19        |
| OUR GREASE GUNS.....                         | 21        |
| AUTOMATIC GREASE CARTRIDGES .....            | 22        |
| MOTORIZED LUBRICATION .....                  | 24        |
| ATD GREASE FOR FISH JOINTS .....             | 25        |
| LUBRICANT FOR STEEL ROPES.....               | 27        |
| LUBRICANTS ANALYSIS KITS .....               | 28        |
| UNIVERSAL GREASING KIT .....                 | 30        |
| MISCELLANEOUS CONSUMABLES.....               | 31        |
| A COMPLETE RANGE OF WELDING EQUIPMENT .....  | 32        |
| <b>SAFETY .....</b>                          | <b>33</b> |
| ANTICOLLISION: WHY EQUIP YOUR CRANES ? ..... | 35        |
| ANTICOLLISION SYSTEM TT3 .....               | 36        |
| ANTICOLLISION SYSTEM MC602 .....             | 37        |
| ANTICOLLISION SYSTEM MC603 .....             | 38        |
| SUPERVISOR FOR ANTI-COLLISION SYSTEMS .....  | 39        |
| HOISTING AND TROLLEY WIRE ROPE .....         | 40        |
| HYDRAULIC TENSIONER .....                    | 41        |
| AIRCRAFT WARNING PACKAGE .....               | 42        |
| SLEWING RING BOLTS .....                     | 43        |
| SLEWING RING SEAL KIT.....                   | 44        |
| <b>STRUCTURE .....</b>                       | <b>45</b> |
| UPGRADE CHASSIS .....                        | 47        |



|   |           |
|---|-----------|
| SUPPORT PLATES.....                                 | 48        |
| SCREW JACKS PROTECTION.....                         | 49        |
| DOUBLE ROPE PULLING GRIP WITH SWIVEL.....           | 51        |
| K MAST FIXING ANGLE SETS.....                       | 52        |
| L MAST FIXING ANGLES SETS.....                      | 53        |
| TIRAX 80.....                                       | 54        |
| 1.2M K MASTS.....                                   | 54        |
| MAST PINS SECURING DEVICE AND PINS REMOVE TOOL..... | 56        |
| WEDGES FOR MASTS STORAGE.....                       | 57        |
| <b>PERIPHERAL PRODUCTS.....</b>                     | <b>58</b> |
| VISION CABINS POTAIN*.....                          | 59        |
| RETROFIT KIT FOR CAB VISOR.....                     | 60        |
| CAB HEATING.....                                    | 61        |
| DIALOG WIND ANEMOMETER.....                         | 62        |
| GIANT DISPLAY XXL.....                              | 64        |
| JOBSITE LIGHTING FOR GME.....                       | 65        |
| ADVERTISING LIGHTING.....                           | 66        |
| DRIVING CAMERA.....                                 | 67        |
| CAB 'IN.....  | 68        |
| CCS TOOL KIT.....                                   | 69        |
| JIB LIFTING BEAM.....                               | 71        |
| MAST PINS SECURING DEVICES.....                     | 72        |
| REMOTE CONTROLS.....                                | 74        |
| REMOTE CONTROL ACCESSORIES.....                     | 75        |
| JOBSITE COMMUNICATION EQUIPMENT.....                | 76        |
| NEW BATTERY 2.75 AH.....                            | 77        |
| <b>SERVICES.....</b>                                | <b>78</b> |
| DOCUMENT REISSUE.....                               | 80        |
| GOODIES.....  | 81        |
| PASSIONATE ABOUT THE POTAIN BRAND?.....             | 81        |
| POTAIN CONNECT+.....                                | 82        |
| POTAIN GOLD OFFER.....                              | 84        |
| 84  |           |
| « STANDARD REPAIR » MOTORS.....                     | 85        |
| TRAINING ACADEMY POTAIN.....                        | 86        |





# POTAIN AT A GLANCE

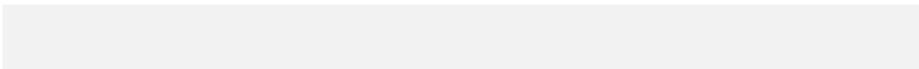



Jan 11: First of its workshop, 1938



RECORD crane from 1938



First automatic bridge, 1975



1st High Tower



Vladivostok Bridge, Russia, 2000

**1918**  
**INNOVATION**  
Opening of the new manufacturing facility in Belgium

**1932**  
**INNOVATION**  
New machine: the RECORD 1 crane

**1954**  
**INNOVATION**  
Telescoping cage

**1959**  
New manufacturing facility in Belgium is acquired

**1970**  
Recruit training program starts

**1965** 1st **10000** CRANE

**1972**  
**INNOVATION**  
First tower crane launch

**1990**  
**INNOVATION**  
First MK luffing jib crane

**1994**  
**INNOVATION**  
Launch of the frequency technology

**1995**  
Potain factory in China opens

**2001**  
**INNOVATION**  
Integration into the Manitowoc crane range and launch of the top range

**2005** 1st **100000** CRANE

**2015**  
**INNOVATION**  
Launch of the new Crane of Foot System (CFS) and CRANETAIL Drag

**2016**  
**INNOVATION**  
Launch of the new CRANETAIL self-erecting cranes

## LAUNCH

of Potain company and its first innovations

## ACCELERATED GROWTH

based on Innovation and Services

## TO CONQUER

the world

## NEW ERA

In a global group dedicated to cranes

**1939**  
**INNOVATION**  
First patent: the RECORD 1 crane

**1991**  
**INNOVATION**  
First 100 jacking crane: RECORD 6

**1955**  
New manufacturing plant opens in Charleroi. A two-sides service unit is also created

**1971**  
Exports of tower cranes to 15 countries and sales offices in 100 world

**1993**  
**INNOVATION**  
First MK hydraulic technology used on cranes for the first time on the MK Mast section

**1997**  
**INNOVATION**  
Launch of first MK self-erecting cranes

**2003**  
**INNOVATION**  
Launch of first MK city tower crane

**2007**  
**INNOVATION**  
First 180 T

**2017**  
**INNOVATION**  
Launch of the new hydraulic luffing jib crane concept

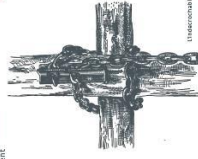

Illustration, 1918



**1975**  
**INNOVATION**  
First tower crane range of self-erecting cranes. The service reaches over 40 countries



Manitowoc Crane, USA, 2001

**2002**  
Creation of the Manitowoc Crane Care service

**2006**  
First 180 T hydraulic luffing jib crane concept, approved in Qatar, Portugal and Dubai, USA



## History

Founded in 1928 by Faustin Potain, POTAIN is the world leader in the production of tower cranes and self-erecting cranes (over 60 types of tower crane).

Potain tower cranes, known worldwide for their hoisting capacities, reliability, and innovative designs, are divided into two product lines.

### > Self-erecting cranes

Agile and easy to handle, self-erecting cranes are especially suitable for residential construction sites.

The Potain offer in self-erecting cranes, the largest and most innovative on the market, provides the user with the best performance for transport, accessibility, erection, dismantling and maintenance. The offer includes ranges renowned throughout the world: Igo, Igo M, Igo T, Hup and Hup M.

### > Top-slewing cranes

Top-slewing cranes are the large construction sites most strategic equipment for productivity. Whether on large infrastructure, high rise jobsites, crowded urban areas or wide open sites, they make it possible to hoist and distribute loads high and far. The Potain brand is a global leader with its multiple ranges of MCT and MDT topless cranes, MR, MRH and MCH luffing jib cranes and large MC, MD and MD Maxi hammerhead cranes that can also be customized to match special applications.

While technologies integrated in the cranes continues to progress, it is important to realize the maintenances to ensure the safety of the material and the humans working with it.





## Manitowoc Direct

In order to help you on a daily basis, we have set an intranet on which you can find numerous technical documents relating to our products.

To find them, go on our Manitowoc website, at [www.manitowoc.com](http://www.manitowoc.com), click on “Manitowoc Direct”, log in or create your account.

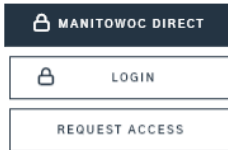

### Manitowoc Direct Request Access

For access to :

1. **Grove CONNECT | Potain CONNECT** – contact your **local dealer** OR your local Manitowoc Support.
2. **On-line Parts Ordering (GPX) & Warranty Claims (GWX)** – contact your local Manitowoc Support.

\* Mandatory fields

#### Personal Information

|                                  |                      |
|----------------------------------|----------------------|
| First Name*                      | <input type="text"/> |
| Last Name*                       | <input type="text"/> |
| Phone                            | <input type="text"/> |
| Mobile Phone                     | <input type="text"/> |
| Fax                              | <input type="text"/> |
| Professional email*              | <input type="text"/> |
| Professional email confirmation* | <input type="text"/> |

#### Company Information

|                 |                      |
|-----------------|----------------------|
| Company Name*   | <input type="text"/> |
| Address 1*      | <input type="text"/> |
| Address 2       | <input type="text"/> |
| City*           | <input type="text"/> |
| State/Province* | <input type="text"/> |



Accueil > Manitowoc Direct > Potain > Parts Support

**Manitowoc Direct**

**Potain**

- Flash Produit (FP)
- Guide Produit (GP)
- ▶ Parts Support
  - Parts Support Level 2
  - Tower Parts and Service handbooks and Warranty procedures

**Customer Support**

- EnCORE Partner Manuals
- North American Distributor Contact Information Update
- Request for Return or Credit
- Customer Support Bulletins
  - Bulletins Pièces
  - Bulletins Pièces
  - Bulletins Tarification
  - Bulletins Service après-vente
  - Bulletins Formation
- Équipes des centres de contact nord-américains
- Policy Manuals

## Potain Parts Support

Contact +33(0)472815151 | [Europetower.parts@manitowoc.com](mailto:Europetower.parts@manitowoc.com)

Show All

**Parts Support**

**Peripheriques - Peripheral**

- Anémomètre-Anemometer - XLS (880.6 KB)
- Balisage aviation - Hazard Lighting - XLSX (868.8 KB)
- Lot VISU-VISU set - XLS (93.7 KB)
- Projecteurs - Projectors - XLSX (2 MB)

**Electrique - Electrical**

- Câbles électriques - Electric cables - XLSX (1 MB)
- Climatisations - Air conditioners - XLSX (583.6 KB)
- Combinateurs Pieces de rechange - Joysticks spare parts - XLSX (7.6 MB)
- Flash et Klaxon - XLSX (1.4 MB)
- Materiel\_Electrique-Electrical\_Material - XLSX (738.6 KB)
- Prises\_et\_Connecteurs-Plugs\_and\_Connectors - XLSX (4.7 MB)

**Mecanique - Mechanic**

- Boulons\_Notice-Bolts\_Instruction - XLSX (193.2 KB)
- Butee et Linguet - Hook Safety Catch and Ball Thrust Bearing - XLSX (2 MB)
- Cables metalliques \_ Wire ropes - XLSX (1.4 MB)
- Lubrifiants\_mecanisme-Mechanism\_Lubricants - XLSX (70.3 KB)
- Roulements\_et\_Joints - Bearings\_Seals - XLSX (708.2 KB)
- Trains de transport\_Transport axes - XLSX (19.8 MB)

**Anti-collision**

- MC602 - XLSX (55.5 KB)
- MC603 - XLSX (1.6 MB)
- Top Site - XLS (826.4 KB)
- Top Zone - PDF (443.1 KB)
- TT2 - XLS (1.1 MB)
- TT3 CCS - HUP - XLSX (397.5 KB)

**Radio commande-Remote control**

- Catalogue\_pieces\_rechange - Spare parts catalog - XLSX (52.2 MB)
- Radiocde retrofit - RRC retrofit - XLSX (1.4 MB)

Accueil > Manitowoc Direct > Potain > Tower Parts and Service handbooks and Warranty procedures

**Manitowoc Direct**

**Mes applications**

**Grove**

**Potain**

- Flash Produit (FP)
- Guide Produit (GP)
- Parts Support
- Parts Support Level 2
- Potain e-Academy

▶ Tower Parts and Service handbooks and Warranty procedures

## Tower Parts and Service handbooks and Warranty procedures

Show All

**Policy-manuals**

- 02BR-Tower-cranes-parts-and-service-handbook-2017-12-0-DE - PDF (1.3 MB)
- 02BR-Tower-cranes-parts-and-service-handbook-2017-12-0-EN - PDF (1.3 MB)
- 02BR-Tower-cranes-parts-and-service-handbook-2017-12-0-ES - PDF (1.3 MB)
- 02BR-Tower-cranes-parts-and-service-handbook-2017-12-0-FR - PDF (1.3 MB)
- 02BR-Tower-cranes-parts-and-service-handbook-2017-12-0-IT - PDF (1.2 MB)
- 02BR-Tower-cranes-parts-and-service-handbook-2017-12-0-PT - PDF (1.3 MB)

**Warranty-Procedures**

- Garantieprocedure\_NL-V11 - PDF (491.8 KB)
- Garantieverfahren Produktreihe Turmdrehkrane EURAF\_DE-V11 - PDF (440.7 KB)
- Procedimento Garantia\_PT-V11 - PDF (521.3 KB)
- Procedimiento Garantizado\_ES-V11 - PDF (405.1 KB)
- Procedura - Garantia\_IT-V11 - PDF (513.6 KB)
- Procedura Gwarancyjna\_PL-V11 - PDF (629.8 KB)
- Procédure Garantie - FR-V11 - PDF (408.1 KB)
- Warranty Procedure\_EN-V11 - PDF (435.3 KB)
- Положения гарантийного обслуживания\_RU-V11 - PDF (533 KB)





## Why choose the genuine part?

### > Expert knowledge - Manufacturer's warranty

Only the manufacturer has an overall view of the product and, by means of its technical proficiency, it guarantees total compatibility. Generic aftermarket parts meet just a few basic criteria and can modify the characteristics of the machine.

### > Advantages of the genuine parts

- ✓ Safety,
- ✓ Manufacturer warranty,
- ✓ Service life,
- ✓ Traceability,
- ✓ High-quality technical support.



### > The risks of the adaptable part

- ✗ Modification of the characteristics of the crane,
- ✗ Security problems with serious human and material risks,
- ✗ Premature wear of other components,
- ✗ Increase in maintenance costs and immobilization of equipment,
- ✗ Cancellation of the “Manufacturer” warranty,
- ✗ No recourse possible against the manufacturer.



Fixing angle

Control panel

Mast section

## Small gain, big risk !





# CONSUMABLES





# Greases for maintenance

To increase the service life of your equipment, Manitowoc recommends the use of these products for routine and regular maintenance.

### Standard quality for slewing ring bearings G2 type

|             |                          |            |   |
|-------------|--------------------------|------------|---|
| E-01032-51* | Cartridge 400 g          | H-01032-54 | ○ |
|             | Cartridge 400 g new pump | 84066032   |   |
|             | Can 5 kg                 | G-01032-53 |   |



### High-quality for slewing ring bearings GM type \*

|             |                          |            |   |
|-------------|--------------------------|------------|---|
| T-61032-74* | Cartridge 400 g          | J-61032-65 | ◊ |
|             | Cartridge 400 g new pump | 84066033   |   |
|             | Can 20 kg                | U-61032-75 |   |



### Aerosol for slewing ring gears and teeth P type

|             |              |            |   |
|-------------|--------------|------------|---|
| P-01032-60* | Spray 400 ml | S-01032-63 | ◊ |
|-------------|--------------|------------|---|



### Specially selected for fish joints by pins ATD type

|             |                 |            |   |
|-------------|-----------------|------------|---|
| N-61032-23* | Can 1 kg        | T-61032-05 | ◐ |
|             | Can 5 kg        | 84066107   |   |
|             | Cartridge 400 g | 84137291   |   |



### Specially selected for topping up grease in reducer gear S00 type

|             |            |            |   |
|-------------|------------|------------|---|
| H-12032-52* | Tube 250 g | 82016145   | ● |
|             | Can 5 kg   | J-12032-53 |   |
|             | Can 50 kg  | K-12032-54 |   |



### Specially selected for topping up grease in reducer gear G0 type

|             |           |            |   |
|-------------|-----------|------------|---|
| K-12032-08* | Can 1 kg  | L-12032-32 | ▼ |
|             | Can 18 kg | P-12032-12 |   |



### Grease for crane-driver lift electric cables

|     |            |          |
|-----|------------|----------|
| TCL | Tube 100 g | 84055311 |
|-----|------------|----------|



### Grease for crane-driver lift pinions and racks

|     |                 |          |
|-----|-----------------|----------|
| TCL | Cartridge 400 g | 84055312 |
|-----|-----------------|----------|

### Brushes

|       |            |
|-------|------------|
| 60 mm | Z-14811-76 |
| 30 mm | K-06444-69 |







**\* Technical code – not to order. Please ask for the reference on the right side.**





# Oils for maintenance

*Selected, tested and adapted to the Potain cranes*

| Oil for reduction gears – RC Type          |               |                   | Symbol  |
|--|---------------|-------------------|---|
| <b>Q-12032-13*</b>                         | Can 5 litres  | <b>W-61032-77</b> |  |
|  | Can 25 litres | <b>S-12032-15</b> |   |
| Oil for reduction gears – HR Type          |               |                   |   |
| <b>H-61032-87*</b>                         | Can 5 litres  | <b>84055632</b>   |  |
|  | Can 25 litres | <b>84108905</b>   |   |
| Oil for reduction gears – HRA Type         |               |                   |   |
| <b>Q-61032-94*</b>                         | Can 5 litres  | <b>84055662</b>   |  |
|  | Can 25 litres | <b>84108906</b>   |   |
| Oil for reduction gears - RSC Type         |               |                   |   |
| <b>S-61032-96*</b>                         | Can 5 litres  | <b>84055634</b>   |  |
|  | Can 25 litres | <b>T-61032-97</b> |   |
| Oil for reduction gears construction hoist |               |                   |   |
| <b>TCL</b>                                 | Can 5 litres  | <b>84055313</b>   |   |



\* Technical code – not to order. Please ask for the reference on the right side.



# Hydraulics oil for maintenance

*Selected, tested and adapted to the Potain cranes*

| Hydraulic oil for telescoping hydraulic units:            |               |                   | Symbol |
|---|---------------|-------------------|--------|
| E Standard Type<br><b>E-12032-26*</b>                     | Can 5 litres  | <b>84108903</b>   | ▲      |
|   | Can 25 litres | <b>G-12032-28</b> |        |
| F Type (Extreme weather conditions)<br><b>B-01032-48*</b> | Can 5 litres  | <b>84108902</b>   | ◻      |
|   | Can 25 litres | <b>D-01032-50</b> |        |
| <i>Can also be used for braking devices</i>               |               |                   |        |
| Hydraulic oil for hydraulic units Hup, IGO, HD cranes:    |               |                   |        |
| I Type<br><b>P-61032-47*</b>                              | Can 5 litres  | <b>84108904</b>   | ◻      |
|   | Can 25 litres | <b>Q-61032-48</b> |        |



*\* Technical code – not to order. Please ask for the reference on the right side*

Scan or click to access online support  
Or contact your usual Potain agent .





# Paints for maintenance

*Selected, tested and adapted to the Potain cranes*

### Primer

|                      |              |                   |
|----------------------|--------------|-------------------|
| Primer beige aerosol | Spray 400 ml | <b>82021847</b>   |
| Primer **            | Can 23,7 Kg  | <b>84062805</b>   |
| Primer Glycero**     | Can 1 kg     | <b>P-65034-24</b> |
| Primer hardener      | Can 3,7 kg   | <b>84062806</b>   |
| Primer Zinc          | Can 1 kg     | <b>82011766</b>   |
|                      | Can 15 kg    | <b>84062558</b>   |



### Solvent

|                              |              |                   |
|------------------------------|--------------|-------------------|
| Dry solvent                  | Spray 400 ml | <b>84138294</b>   |
| Paint thinner X400 - Glycero | Can 5 l      | <b>F-11034-99</b> |
| Thinner primer               | Can 25 l     | <b>B-68034-24</b> |
| Lacquer thinner PU/THES      | Can 25 l     | <b>84077707</b>   |

### Hardener for polyurethane lacquer PU/THES

|  |          |                 |
|--|----------|-----------------|
|  | Can 5 kg | <b>84012719</b> |
|--|----------|-----------------|

### Yellow paint for cranes supplied after 1992

|                |             |                   |
|----------------|-------------|-------------------|
| SPU FIN THES** | Can 13,5 kg | <b>84061724</b>   |
| Glycero**      | Can 1 kg    | <b>K-65034-66</b> |



### Paint for daytime hazard lighting\*\*

|                 |             |                   |
|-----------------|-------------|-------------------|
| Red PU/THES**   | Can 13,5 kg | <b>84061399</b>   |
| Red Glycero**   | Can 1 kg    | <b>N-65034-69</b> |
| White PU/THES** | Can 13,5 kg | <b>84061397</b>   |
| White Glycero** | Can 1 kg    | <b>R-65034-95</b> |

**\*\* Use with the appropriate hardener!**



# Paints for maintenance

*Selected, tested and adapted to the Potain cranes*

### Red paint

|                |             |                   |
|----------------|-------------|-------------------|
| SPU FIN THES** | Can 13,5 kg | <b>84061416</b>   |
| Glycero**      | Can 1 kg    | <b>K-67034-74</b> |

### POTAIN grey lacquer :

|   |              |                   |
|---|--------------|-------------------|
| Aerosol                                 | Spray 400 ml | <b>Z-67034-18</b> |
| PU/THES: for cranes supplied after 2000 | Can 13,5 kg  | <b>84061420</b>   |
| Glycero                                 | Can 1 kg     | <b>L-66034-71</b> |
|   | Can 25 Kb    | <b>W-67034-16</b> |

### POTAIN galvanised lacquer \* :

|                                      |              |                 |
|--------------------------------------|--------------|-----------------|
| Matt Paint Aerosol (Old-age effect)  | Spray 500 ml | <b>82013254</b> |
| Gloss Paint Aerosol (New-age effect) | Spray 400 ml | <b>84121855</b> |

### POTAIN yellow lacquer 92 :

|         |              |                 |
|---------|--------------|-----------------|
| Aerosol | Spray 400 ml | <b>82028322</b> |
|---------|--------------|-----------------|

### White lacquer:

|                      |              |                   |
|----------------------|--------------|-------------------|
| Aerosol              | Spray 400 ml | <b>84116146</b>   |
| Polyurethane lacquer | Can 13,5 kg  | <b>84063456</b>   |
| Glycero              | Can 1 kg     | <b>M-65034-68</b> |

### Blue lacquer:

|         |              |                 |
|---------|--------------|-----------------|
| Aerosol | Spray 400 ml | <b>82001191</b> |
|---------|--------------|-----------------|

### Red lacquer:

|         |              |                   |
|---------|--------------|-------------------|
| Aerosol | Spray 400 ml | <b>S-67034-35</b> |
|---------|--------------|-------------------|



\* Essential in the inspection vehicles!



# Our grease guns

*Because lubrication is an essential aspect for the maintenance of your cranes, discover our range of grease guns*

## Electric grease gun

For precise and easy lubrication, even under difficult conditions



- Battery : 12 Volts Li-ion. Charger included.
- Pressure : 562 bars
- Battery life : ±7 cartridges with a single charge
- Hose : 91 cm
- Charging indicator

## Manual grease gun

Provides ergonomic lubrication, with its magnetic holder



- Pressure : 800bars
- Weight : 1,4 kg
- 2,5cc for each pump

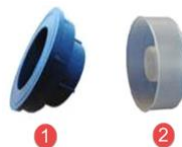

The kit includes 1 adapter for screw-on cartridge (1) and 10 sealing lids for traditional cartridges (2).

Discover our automatic and motorized lubricator solutions, as well as all our lubrication products in our [quick reference catalogue](#).

### References

| Grease guns                                     |            |            |
|---|------------|------------|
| Electric grease gun                             | 84155029   |            |
| Additional battery                              | 84155031   |            |
| Manual grease gun kit                           | 84066027   |            |
| Screw-on cartridge adapter (1)                  | 84066028   |            |
| Set of 10 traditional cartridge sealing lid (2) | 84066029   |            |
| Grease cartridges 400g                          | <b>G2</b>  | <b>GM</b>  |
| Traditional                                     | H-01032-54 | J-61032-65 |
| Screw-on  | 84066032   | 84066033   |



# Automatic Grease cartridges

Extend the lifetime of your slewing rings thanks to an efficient greasing:

- Greasing no less than 3 months,
- 6 bars pressure,
- Mounting possibilities on other greasing points,



For optimal longevity, we recommend that you use a reinforced connection.

## > Kits for GME and GMA range

### Complete grease cartridge

- Programming by LCD display,
- LED lights with indicators,
- Reusable drive system,
- Delivered with a 120cm<sup>3</sup> cartridge and Battery Pack.



### Reinforced connection

- Recommended for all uses, especially in the event of vibrations or collision risks with other parts, when the cartridge are offset.

### Refills (*batteries included*)

- 120cm<sup>3</sup>: ~ 3 months
- 250cm<sup>3</sup>: ~ 6 months

## > For GMEs only

### Complete chemical grease cartridge

- Time stretch duration by switch, simplified use,
- Compact system: 125cc cartridge, no fitting or battery needed.

## > For old GMA (HD/GTMR)

### Special retrofit kit

- For automatic greasing system (complete system and connection to be ordered separately)





# Automatic Grease cartridges

## References

| Articles   |         |                     |               |            |
|--|---------|---------------------|---------------|------------|
| Complete greasing cartridge (with cartridge 120cm <sup>3</sup> , batteries and support)              |         |                     |               | J-01458-97 |
| Battery Pack   |         |                     |               | 82007821   |
| Complete greasing cartridge cold countries (with cartridge 120cm <sup>3</sup> and batteries support) |         |                     |               | 84116687   |
| Delivered without batteries (Lithium 3 x AAA 1.5V)   |         |                     |               |            |
| Complete chemical greasing cartridge   |         |                     |               | 84031284   |
| Reinforced connection (regular greasing cartridge, GMA kit or Very cold weather)                     |         |                     |               | K-01458-98 |
| Specific retrofit kit for GMA/HD/GTMR  |         |                     |               | N-51458-02 |
| Reducing adapters  | M10x100 | Q-75375-51          | M10x150       | V-75375-56 |
|  | M8x125  | W-75375-57          | Elbow fitting | X-75375-58 |
| Refills  |         |                     |               |            |
| Refills classical grease (delivered with support + batteries)  |         | 120 cm <sup>3</sup> |               | Q-62505-40 |
|  |         | 250 cm <sup>3</sup> |               | H-62505-56 |
| Refills Cold countries grease  |         | 120 cm <sup>3</sup> |               | 84116686   |



Motorized lubrication also available, please have a look at our dedicated SPN.

Scan or click to access online support  
Or contact your usual Potain agent





# Motorized lubrication

*Simplify your lubrication operations*

## > Standard system for slewing ring lubrication

- Compact greasing system only operates during a slewing motion (programming),
- Up to 20 greasing points simultaneous,
- Tank contains 1,2 kg of grease lasts for 3 to 6 months (depending of the use),
- 4 grease cartridges are included in the kit,
- Supply voltage: 0 – 60VCD\*,
- Temperature range: -35 à +70°C,



\* For use on CCS Crane : please order in addition an electrical adaptor kit.

## > Optional: tothing lubrication\*\*



10 modules tothing kit

- Tothing lubrication is ensured by a greasing pinion and a pumping element fixed on the unit; connected together by a hose,
- While operating, only the pinion face which is in contact with the slewing ring ensures the lubrication,
- This pinion is fixed by means of a support to be welded on the towerhead.

\*\* Please contact your usual agent.

Scan or click to access online support  
Or contact your usual Potain agent.







# Motorized lubrication

*Simplify your lubrication operation*



*Unit with 4 greasing points*



## References

### Kits

|                                |                   |
|--------------------------------|-------------------|
| Kit 4 Internal Greasing Points | <b>K-21995-45</b> |
| Kit 6 Internal Greasing Points | <b>L-21995-46</b> |
| Kit 8 Internal Greasing Points | <b>M-21995-47</b> |
| More 8 points                  | <b>Contact us</b> |

### Miscellaneous

|                     |                   |
|---------------------|-------------------|
| 4 grease cartridges | <b>J-61032-65</b> |
| CCS Adaptator kit   | <b>84004522</b>   |



For some tower cranes, we propose grease recuperator kits to ensure the cleanliness of towerhead and security of accesses.

In addition, we also propose a range of grease cartridges for tower cranes. Please see our Spare Parts News.

Scan or click to access online support  
Or contact your usual Potain agent.





# ATD Grease for fish joints

*Safety and operation ensured for a long time !*

This product is complying with a strict Potain specifications sheet, ensuring a controlled wear of fish joints by pins, subject to use at each assembly.

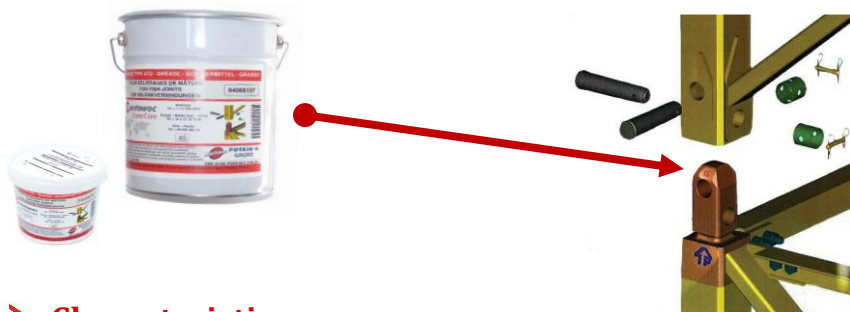

## > Characteristics

- Designed to increase pin's mast assembling lifetime,
- Fitting and dismantling of the pins facilitated,
- To be used at each assembly,
- Contains additives to protect the surfaces of the assembled parts, even under high pressure.

## > Advantages

- Protects against corrosion and fretting corrosion,
- Waterproof and adapted to off shore locations,
- Slows down the ovalization of the borings and the wearing,
- Very strong adhesive force on the metallic surfaces,
- Excellent thermal stability : can be used from -25°C to + 50°C and can be stored from -40°C to + 60°.

## References

Specially selected for mast fish joints

|          |                |                   |
|----------|----------------|-------------------|
| Type ATD | Can 1 kg       | <b>T-61032-05</b> |
|          | Can 5 kg       | <b>84066107</b>   |
|          | Cartridge 400g | <b>84137291</b>   |





# Lubricant for steel ropes

*Extends the life of your wire ropes*

Only for the hoisting and luffing steel ropes.

## > Advantages

- Deposits a protective oil film which resists to the mechanical pressures naturally generated by the external fittings (pulleys, drums...),
- Reduces frictions, abrasive wear and fouling,
- Protects against rust and corrosion,
- Penetrates quickly and deeply in steel rope to lubricate strands and cores,
- Weather resistance,
- Extends life of heavily loaded wire ropes, pulleys, drums, guides, pins and rollers.



## > Operating instruction

- For effective application, we recommend you clean the wire rope carefully before processing,
- Spray a thin layer in several times for optimal protection,
- For ease, apply the spray when the wire rope is being wound on the drum.



Recommended by Potain for the maintenance of wire ropes of its cranes

## References

**Grease Aerosol**

Spray 400 ml LC

**P-61032-70**



- Lubic 08 22 EN



# Lubricants analysis kits

*Optimize your maintenance costs*

## > Why making regular maintenances ?

To extend the reliability and service life of your cranes, Potain recommends to realize maintenances on your crane :



- **Preventive maintenance** : To anticipate and prevent malfunctions or broken parts. It's based on regular maintenance (routine operation) and detailed maintenance (inspection of key components),
- **Corrective maintenance** : Repairs or change some parts of the crane, arrived to its end-of-life, to ensure security and performance.

## > Lubricants analysis kits: to monitor lubricants quality

Scheduling preventive maintenance programs helps to keep your costs down. Potain has developed a lubricant analysis kit, in 2 version :

- Oil analysis kit : reduction gears and hydraulic units,
- Grease analysis kit : slewing rings and reduction gears.

In addition to your current preventive maintenance programs, lubricant analysis makes it possible to monitor the quality of oils and greases in service and therefore to detect the state of wear or degradation of lubricated parts.

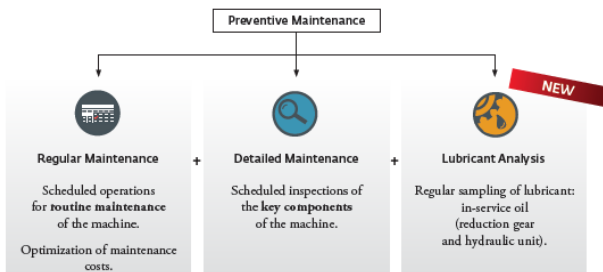

For more information, please check our product guide 626 on our website.





# Lubricants analysis kits

## References

### Analysis kit

|                     |                 |
|---------------------|-----------------|
| Oil analysis kit    | <b>84052659</b> |
| Grease analysis kit | <b>84052660</b> |

Grease analysis kit



Oil analysis kit



The kit includes, whatever the type,

- Sample bottle
- Hose
- 2 stickers to identify the sample and the descriptive file
- A pre-paid envelop to send the sample and the demanding file to a specialized and dedicated laboratory .

Scan or click to access online support  
Or contact your usual Potain agent.





# Universal greasing kit

**Maintain your crane!**

If your crane is equipped with a battery-operated motorized lubrication system, the grease cartridges must be replaced periodically to ensure proper lubrication of the slewing ring. Potain also recommends greasing the hoist rope periodically to increase its service life.



## > Characteristics

- 4 refills for automatic grease nipples,
- 1 spray of P grease for ring teeth,
- 1 spray of LC grease for hoist rope,
- One kit covers: 6 months maintenance for a GMA, 3 months for a GME.

## > Advantages

- Better availability: fewer job site stops,
- You save money in the medium term: fewer replacements of expensive components,
- Optimized resale value.



You can record your maintenance operations in our reference maintenance logbook: V-85985-92

## References

|  |                 |
|--|-----------------|
| <b>Universal lubrication kits for cranes with automatic greasing</b> |                 |
| Complete kit for GME or GMA  | <b>84129896</b> |

- Kitu 11 22 EN



# Miscellaneous consumables

*Selected, tested and adapted to the Potain cranes*



### Anti-seize compound\*

Spray 400 ml **K-01035-78**

### Anti-seize agent\*

Spray 400 ml **E-01035-27**



### Anti-seize paste copper

Tube 200 gr **L-15031-98**

### Anaerobic fixation

Bottle 75 ml **R-12035-36**



### Cyanoacrylate adhesive\*

Bottle 20 gr **H-12035-05**

### Rust converter

Can 1l **84139193**

### Anti-corrosion

Can 650ml **82032659**

### Brake cleaner

Spray 500ml **84126744**

### Repair kit glass bonding

Tube 412 gr **82020617**

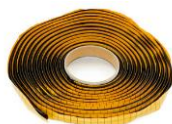

### Mastic adhesive

D8 Roll 6 m **V-02031-32**



### Insulating adhesive tape\*

Set 10 insulating adhesive tapes **B-61031-43**

*\* Essential in the inspection vehicles!*

Scan or click to access online support  
Or contact your usual Potain agent.



If you require more information, please contact your usual correspondent or contact us via e-mail address : [europetower.parts@manitowoc.com](mailto:europetower.parts@manitowoc.com) – Non-contractual document, reproduction prohibited



# A complete range of welding equipment

Enjoy quality accessories and consumables at an attractive price!

| Welding leads         |          |
|-----------------------|----------|
| Lead G3Si 1 D 1       | 82030756 |
| Lead G3Si1 D 1,2      | 82030757 |
| Lead MONIVA G69 D 1.2 | 84118288 |



| Welding electrodes     |            |
|------------------------|------------|
| Electrode D2,5 HTS     | B-01043-98 |
| Electrode D3,2 HTS     | C-01043-99 |
| Electrode D2,5 Spezial | C-01043-53 |
| Electrode D3,2 Spezial | D-01043-54 |
| Electrode D4 Spezial   | E-01043-55 |



| PPE  |          |          |          |
|--|----------|----------|----------|
| Protection tarpauline 1300° 1800 x 2000 mm |          |          | 82022645 |
| Welding mask                               |          |          | 84145162 |
| Gloves                                     | Size 9   | Size 10  | Size 11  |
|  | 84145163 | 84145164 | 84145165 |



| Tools  |          |
|--|----------|
| Welding bead control tooling A4 to A16       | 84117724 |
| Welding bead control tooling A4 to A14 / A18 | 84121759 |
| Infrared thermometer -60/500°C               | 84133591 |
| Portable oven                                | 84141132 |



| Spray consummables      |            |
|-------------------------|------------|
| White paint marker 3mm  | 84141112   |
| Black paint marker 3 mm | 84139227   |
| Solvent spray 300 ml    | J-01035-08 |
| Penetrating spray 400ml | H-01035-07 |
| Revealing spray 400ml   | K-01035-09 |







# SAFETY





# Anticollision: Why equip your cranes ?

Increasingly complex job site configurations, tight delivery times, architectural constraints...All of these factors can put the smooth running of your job site, at risk !

Working **safely**, **minimize** unforeseen expenses and **increase productivity** are the keys to SUCCESS.

The anti-collision system meets these requirements by offering a simple and cost-effective solution:

### > A secure job site!

- Multiple cranes working at the same time? Overflight zones to avoid ? All these conditions create a risky work environment.
- As a machine operator, protecting people who work or gravitate around the job site is your responsibility.

### > Controlled costs!

- Damage caused by an accident is severe and the resulting financial losses can be considerable.
- Now update the check using a dedicated system !

### > Improved productivity!

- A safe environment, optimized travel speeds, controlled decelerations and stops.
- The crane driver can safely concentrate on their main tasks.

Scan or click to access to our anticollision offer  
Or contact your usual Potain agent.





# Anticollision system TT3

## Anticollision system

An anti-collision system\*, meeting the regulations in effect, for the control of work areas and the management of interference for all types of tower cranes.

### > Characteristics

- Travelling sensor with several registration points (several RFID tags),
- Inter-crane management / configuration of prohibited areas,
- Hook height management in prohibited areas,
- If TT3 "shunted" in the CCS, visual indication on the screen,
- Black box (one year of memory) and possible filters:
  - Faults, sensor by sensor
  - Recording of access (identifiers / dates / access)
  - Weathervanes
  - Neutralizations



Calculator

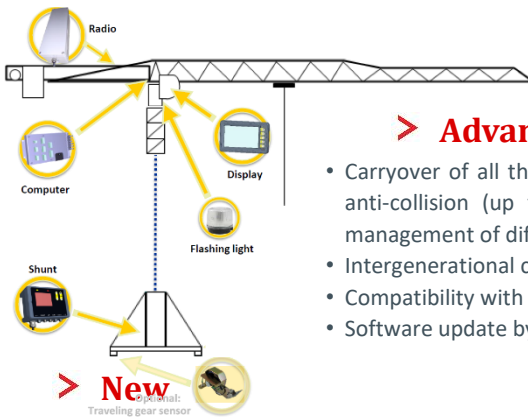

### > Advantages

- Carryover of all the previous generation systems functionalities: anti-collision (up to 16 cranes), prohibited areas (up to 30), management of different radios (frequencies),
- Intergenerational compatibility of systems (including with TT1),
- Compatibility with Supervisor 603 (optional),
- Software update by USB key only.

- > **New**  
Optional: Traveling gear sensor
- New color touch screen
- Day or night mode display setting
- Wind speed visible directly on the neutralization box.
- Possibility of neutralization:
  - Prohibited zones zone by zone,
  - Crane-by-crane interference.
- If number of cranes  $\geq 16$ , possibility to connect another radio.
- Remote setting of systems between cranes.





# Anticollision system MC602

*For all brands and types of cranes*

## > Characteristics

- New display: indicator and anti-collision (height, range, load, moment, wind speed, pre-alarm and anti-collision alarm, interference zone),
- Universal computer box for all types of cranes (models and brands),
- Translation encoder with anemometer signaling,
- Recording of events and possible failures.

Display



## > Key point

- Prevents the danger of collision, limits the crane working zone ( Prohibited overslewing of buildings, aerial lines...),
- Driving aid system,
- Controls the interferences between cranes,
- Remote monitoring,
- Communication with the previous Top tracing I and II.

## > Reliability and simplicity

- Digital technology, transmission by CAN bus network,
- Processing unit protected in a tight housing - IP65,
- Crane driver information (dangerous areas),
- Calibration and adjustment protected by a password,
- Pre-wired input/output function, Harting connector,
- Optional: signal lamp in case of malfunctioning, shunt box.

## > Compatibility

- MC603,
- TOP TRACING 2,
- TOP TRACING 3.



Calculator

Scan or click to access online support  
Or contact your usual Potain agent.





# Anticollision system MC603

## Anticollision system



### > Advantages

- Compliant with European standards EN 14439 and EN 17076,
- Certified as PLC according to ISO13849,
- Simple installation and intuitive calibration,
- Software updated using USB drive,
- FREE software upgrades,
- Individually neutralizable prohibited zones.

### > Designed for which cranes ?

- System adaptable to all crane brands:
  - GME : Saddle jib and luffing jib,
  - GMA.

### > Compatibility

- MC602,
- TOP TRACING 2,
- TOP TRACING 3.

### > Crane with CCS or CAN bus

- The system connects directly to the CAN bus interface of the crane.
- For other technologies, the system is connected to the crane via an interface box.

### > Options

- Supervisor, wireless neutralization box for collector cranes.



Calculator



Shunt box



Interface

Scan or click to access online support  
Or contact your usual Potain agent.





# Supervisor for anti-collision systems

*A monitoring tool for your remote job sites*

## > Characteristics

- Compatible with all anti-collision systems distributed by Potain (up to 16 cranes),
- Graphic view of the job site in real time,
- Event recorder (visualization of sensor faults, radio, wind\*, etc.),
- Data export,
- Remote connection via an IP address,
- Option: Radio connection.

## > Pack components

- 1 PC,
- 1screen,
- 1 connection box.

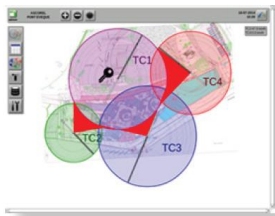

\* Excluding Top Tracing II

## References

### Articles

Complete pack Supervisor

84076986

Scan or click to access online support  
Or contact your usual Potain agent.





# Hoisting and trolley wire rope

*High-performance ropes at competitive prices*

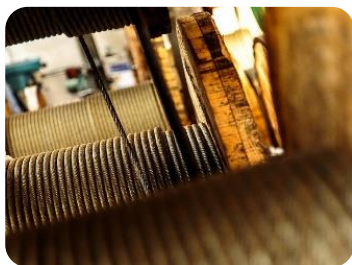

## > Advantages

- Performance: lifespan increased by at least 25%\*
- Versatility: compatible with all your machines (CCS or not).
- Service: Stock available and advice adapted to your applications.
- Traceability: Identification by coloring an outer strand.

*\* Compared to a regular range*

## > Hoisting wire rope range

- PREMIUM 24 strand compacted rope, 7 steel wires, steel metal core.
- HIGH PERFORMER/E 25 strand compacted rope, 7 steel wires, steel metal core.
- HIGH PERFORMER/S 29 strand compacted rope, 7 steel wires, steel metal core.

## > Trolley wire rope range

- PREMIUM 6 strand compacted rope, 19 steel wires, textile core.
- HIGH PERFORMER 9 strand compacted rope, 7 steel wires, steel metal core.



Scan or click to access online support  
Or contact your usual Potain agent .



- Caba 03 23 EN





# Hydraulic tensioner

## For slewing ring bolts

The hydraulic tensioner is an essential tool to ensure the perfect tightening of the bolts of the slewing ring of your GME.

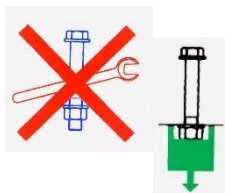

- The tightening of the slewing ring bolts must comply with strict rules
- The use of hydraulic tension bolts on GME cranes (implementation during 2000) requires the use of a specific torque tools.
- Potain offers two different types of tensioners, for M20 to M27 bolts with a single high-pressure hand pump.

### > Hand pump characteristics

- Hose length 3m with rapid connector.
- Oil pressure gauge.
- The unit is supplied in a box.



### > Tensionners\*

- Bolts M27.
- Bolts M20, M22 and M24.

\* For other sizes, Please contact us.

## References

### Hand pump

Complete pump with box

**U-64435-37**

### Tensionners

Bolts M27

**82017094**

Bolts M20, M22 and M24

**82017093**

Scan or click to access online support  
Or contact your usual Potain agent







# Aircraft warning package

*More complete, more competitive !\**

## > Advantages

- Works on all crane types: saddle jib and luffing jib,
- Autonomous operation: 48 h for night lighting / 12 h for daytime lighting,
- A single 230/400V dual-voltage control panel for all types of lights (LI/MI for night and MI for daytime),
- Low power consumption (LED technology),
- IP66 ingress protection.

## > Standard package

|             |                 | Night  | Day  |
|-------------|-----------------|--|--|
| Total crane | H < 45 m        | <b>Low intensity</b> <ul style="list-style-type: none"> <li>▪ Overmoulded single-piece unit, 3 x 32 Cd LED.</li> <li>▪ Connection with moulded cable, no risk of corrosion.</li> <li>▪ Control box with integral photoelectric cell.</li> </ul>   | <b>Medium intensity</b> <ul style="list-style-type: none"> <li>▪ 1 medium intensity light with 6 bi-colour LED floodlights:                             <ul style="list-style-type: none"> <li>▪ Day: white 20,000 Cd (type A),</li> <li>▪ Night: red 2,000 Cd (types B and C).</li> </ul> </li> <li>▪ Integral GPS module for day/night switching</li> </ul>  |
|             | 45m < H < 150 m | <b>Medium intensity</b> <ul style="list-style-type: none"> <li>▪ 1 medium intensity light with 2,000 Cd.</li> <li>▪ Adjustable flash rate:                             <ul style="list-style-type: none"> <li>▪ Type B: 20 to 60 flashes per min,</li> <li>▪ Type C: light permanently on.</li> </ul> </li> <li>▪ Integral GPS module for day/night switching.</li> </ul>  |  |
|             |                 | H > 150 m  | High intensity light: contact us for details.  |



All our systems are provided with an emergency control panel and the supports, cables and accessories needed for installation. The supply voltage is 48 V DC.

For any other requests, contact us. We will give you a custom quotation.

*\* Our aircraft warning lights comply with the requirements of the OACI and the FAA. Approval of the system by the local civil aviation authority remains the responsibility of the customer.*

Scan or click to access online support  
Or contact your usual Potain agent.





# Slewing ring bolts

*Check or regularly change your bolts*

## > Follow the manufacturer recommendations



- **Every year** : Verification of the tightening of the slewing ring bolts, following the instructions of the service guide provided with the crane.
- **Every 8 years or 16 000 hours working hours**: Systematic pre-ventive exchange of the slewing ring bolts untreated (black's) every 8 years or after 16000 hours of operation of the machine, 1<sup>st</sup> term reached.
- **Every 12 years or 24 000 hours working hours**: Systematic preven-tive exchange of the slewing ring bolts treated (grey's) every 12 years or after 24000 hours of operation of the machine, 1<sup>st</sup> term reached.
- **Systematic exchange** of the slewing ring bolts by change of the slewing ring of the crane, unless specific instructions from Potain.

## > Characteristics

- Specially selected and adapted to your crane,
- Define according to specific standards that meet,
- Precise specifications imposed to all our suppliers,
- Traceability for all bolts.



In addition, we offer a rust protector for HR slewing bolts.

### Protector for HR bolt

Spray 650ml

**82032659**



Scan or click to access online support  
Or contact your usual Potain agent.





# Slewing ring seal kit

This slewing ring seal kit is for use with GMA-GME cranes of the Potain brand.



### > Advantages

- You order the entire assembly and only replace those items used,
- Compact, all-in-the box,
- You always have everything you need for your operations.

### > Characteristics

- The kit includes 5 airtight seals with lengths of 2 x 7 meters:
  - Z-61031-41
  - V-61031-15
  - Q-61031-79
  - Q-61031-56
  - G-15031-02
  - 2 x 20 g bottles of Cyanolite
  - H-12035-05 glue
  - 1 lidded box 84034044

### > Selecting a profile

To determine which seal profile you need for your slewing ring, please consult the table below

| Reference  | Profile | On millimeter paper (*) |
|------------|---------|-------------------------|
| Z-61031-41 |         |                         |
| V-61031-15 |         |                         |
| Q-61031-79 |         |                         |

| Reference  | Profile | On millimeter paper (*) |
|------------|---------|-------------------------|
| O-61031-56 |         |                         |
| J-15031-04 |         |                         |
| G-15031-02 |         |                         |
| H-15031-03 |         |                         |

## References

### Kit of 5 airtight seals

Complete kit 5 seals

*Included box with lid*

*Included : Cyanolite glue bottle*

**84034143**

**84034044**

**H-12035-05**

- Kitc 08 22 EN



# STRUCTURE





# Upgrade chassis

*Improve safety and ergonomy !*

POTAIN, in cooperation with the Fédération Nationale des Travaux Publics (French National Federation of Public Works), has worked on improving safety and ergonomics when unloading the packages and fitting the V60A chassis for 2 m masts.

## > Main improvements

- Handling: Creation of slinging points and guide handles,
- Packaging of struts + half-bearers allow safe unloading with less handling and more space on the job site.
- Basic mast section: Creation of a fixed, central catwalk and two foldable side catwalks to facilitate the pin-connection of the struts, platforms with four angles facilitating the pin-connection of the mast section, and tubes used as a guard rope for harnesses,
- Pins from the top: Improved accessibility for mast section/half-bearer pin connections,
- Two beams allowing the basic mast section to be stabilized in a vertical position on a ballast block.

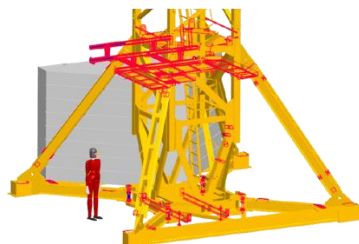
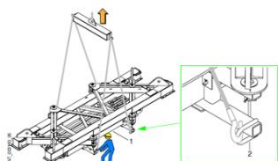

## References

### Chassis kit

S41A – Kit upgrade

**84010255**

V60A– Kit upgrade

**84000349**

V63A– Kit upgrade

**84005134**

Scan or click to access online support  
Or contact your usual Potain agent.



- Kchb 08.22 EN



# Support plates

*Ensure the stability of your crane*



Let's contribute together to the protection of the nature by using recycled materials !

Made from composite material, the support plates proposed by Potain are a better substitute for wooden plates which are usually used for supporting GMA cranes or mobile crane.

## > Characteristics

- Very strong: no splitting,
- Very long lifespan: do not rot or absorb moisture,
- Easy to clean,
- Excellent Quality/Price ratio compared with wood,
- Very light (density 1) and easy to manipulate with their handles.



## > Different shapes

- Standard Rectangle models,
- Standard square models,
- Standard round models.



In order to determine the support plate type, consider the maximum reaction under your crane bearing (indicated by the constructor) as well as the permissible maximum pressure of the ground where the crane will be erected.



If the ground pressure is not  $\geq 2,5 \text{ daN/cm}^2$ , please contact us.

*\* Please consult us for any other dimension at your convenience.*

Scan or click to access online support  
Or contact your usual Potain agent.







# Support plates

## References

### Rectangle models

|                |       |              |   |                   |  |
|----------------|-------|--------------|---|-------------------|--|
| 750 x 1000 mm  | 50 mm | 38kg / piece | 4 | <b>Z-82985-60</b> | Igo 15, 18, 21, 22, 26, 30, M 21, MA 21                      |
| 1000 x 1200 mm | 60 mm | 72kg / piece | 4 | <b>W-82985-58</b> | Igo 32, 36, 42, 50, GTMR 331C, Hup 32-27, 40-30, Hup M 28-22 |
| 1000 x 1200 mm | 80 mm | 96kg / piece | 4 | <b>D-83985-22</b> | Igo 32, 36, 42, 50, GTMR 331C, Hup 32-27, 40-30, Hup M 28-22 |
| 1000 x 330 mm  | 80 mm | 32kg / piece | 4 | <b>B-84985-24</b> |  |

### Square models

|                |        |                |   |                   |   |
|----------------|--------|----------------|---|-------------------|---|
| 400 X 400 mm   | 50 mm  | 8kg / piece    | 2 | <b>S-86985-70</b> |   |
| 600 x 600 mm   | 40 mm  | 15kg / piece   | 4 | <b>V-82985-57</b> | Igo 10, 11, 13, M 14                    |
| 600 x 600 mm   | 60 mm  | 21,5kg / piece | 4 | <b>X-86985-98</b> |   |
| 600 x 600 mm   | 60 mm  | 28,5kg / piece | 4 | <b>J-86985-39</b> |   |
| 750 x 750 mm   | 50 mm  | 28kg / piece   | 4 | <b>F-83985-93</b> |   |
| 800 x 800 mm   | 40 mm  | 25,5kg / piece | 4 | <b>E-86985-12</b> |   |
| 800 x 800 mm   | 50 mm  | 32kg / piece   | 4 | <b>C-86985-56</b> |   |
| 800 x 800 mm   | 60 mm  | 38kg / piece   | 4 | <b>Z-86985-76</b> |   |
| 1400 X 1400 mm | 100 mm | 200kg / piece  | 4 | <b>82029208</b>   | Igo T70, T85A, T130, HDT 80, GTMR 386 B |

### Round models

|       |       |              |   |                   |   |
|-------|-------|--------------|---|-------------------|---|
| Ø 700 | 50 mm | 19kg / piece | 4 | <b>82008919</b>   |   |
| Ø 800 | 50 mm | 25kg / piece | 4 | <b>82003476</b>   | Igo 10, 11,13,15,18,21, M 14, M 21          |
| Ø 900 | 40 mm | 38kg / piece | 4 | <b>A-86985-54</b> |   |
| Ø 900 | 60 mm | 38kg / piece | 4 | <b>B-86985-55</b> | Igo 22, 26, 30, Hup M 28-22                 |
| Ø1000 | 80 mm | 62kg / piece | 4 | <b>W-85985-24</b> | Igo 32                                      |
| Ø1200 | 60 mm | 68kg / piece | 4 | <b>82003475</b>   | Igo 36, 42, 50, GTMR 331C, Hup 32-27, 40-30 |
| Ø1200 | 80 mm | 95kg / piece | 4 | <b>03142474</b>   | Igo 36, 42, 50, GTMR 331C, Hup 32-27, 40-30 |



# Screw jacks protection

The support plate protection preserves the screw thread from dust and concrete.

## > Characteristics

- The setting of support plates remains easy even after several construction sites usages.
- The assembly is possible on a crane in operation.
- Compatible with chassis
  - ZC4230
  - ZD4230
  - ZD463
  - ZX6830



## References

### Screw jacks protection

Set of 4 protections (for one chassis)

**84058203**

Scan or click to access online support  
Or contact your usual Potain agent.



- Ppsc 08 22 EN



# Double rope pulling grip with swivel

*Make your rope changes safer*

These new generation cable pulling grips with central swivel are ideal for safe wire ropes replacement. Usable for ropes without termination and with diameters greater than 8 mm.

*They meet the obligations of European regulations, in particular the "Machinery" Directive 2006/42/EC.*



## References

| Rope diameter |          |
|---------------|----------|
| 8/10          | 84063553 |
| 10/15         | 84051421 |
| 15/20         | 84051422 |
| 20/25         | 84063554 |
| 25/30         | 84063564 |
| 30/35         | 84063565 |

Scan or click to access online support  
Or contact your usual Potain agent.





# K mast fixing angle sets

*Ensure the safety with genuine components*

For more flexible management of your equipment, we propose equipped fixing angles in the form of a kit.

## > Characteristics

The kit is composed of :

- 1 kit of 4 unequipped fixing angles
- 1 fishplate kit
- 1 pin kit



Please find a summary table for our offer below:

| Old equipped fixing angle sets* | Commercial name | Unequipped fixing angle set | Fishplate kit | Pin kit  | Pin version |
|---------------------------------|-----------------|-----------------------------|---------------|----------|-------------|
| 84138885                        | P24A/P42A       | 84138886                    | 84070143      | 84070146 | Standard    |
| 84138888                        |                 |                             |               | 84070147 | Tirax       |
| U-61109-57                      | P41A            | W-61109-59                  | 84070143      | 84070146 | Standard    |
| V-61109-58                      |                 |                             |               | 84070147 | Tirax       |
| 82031776                        | P61B            | 82031909                    | 84070144      | 84070148 | Standard    |
| 82031775                        |                 |                             |               | 84070149 | Tirax       |
| 82028042                        | P62B            | 82028835                    | 84070144      | 84070150 | Standard    |
| 82028041                        |                 |                             |               | 84070151 | Tirax       |
| 82049608                        | P800B           | 82025958                    | 84070144      | 84070152 | Standard    |
| 82049609                        |                 |                             |               | 84070153 | Tirax       |
| 82049598                        | P850A           | 82014499                    | 84070145      | 84070154 | Standard    |
| H-20680-29                      |                 |                             |               | 84070155 | Tirax       |
| B-18680-61                      | P854A           | 84071651                    | 84070145      | 84070154 | Standard    |
| W-14108-17                      |                 |                             |               | 84070155 | Tirax       |
| 84138912                        | P880            | 84136916                    | 84142895      | 84142896 | Standard    |
| 84136913                        |                 |                             |               | 84142897 | Tirax       |



\* The former equipped Part Number cannot be ordered anymore ! The fishplate kit cannot be ordered alone.



# L mast fixing angles sets

*Ensure the safety with genuine components*

We propose you our full range of sets of fixing angles for L mast, with or without pin!



### > You have pins and want to reuse them?

Order only a set of bare fixing angles and economize the price of pins !

### > You need pins?

We propose a kit containing:

- 8 pins,
- 4 shafts,
- and 4 safety-pins



### > You want an equipped set of fixing angles ?

You can order a set of bare fixing angles **and** a pins kit.

Please find below a chart that summarizes our offer

| Commercial name     | Former P/N for set of fixing angles with pins* |   | New P/N for fixing angles without pin |   | New P/N for kits pins + shafts |
|---------------------|--|---|---------------------------------------|---|--------------------------------|
| P12B                | B-77109-81                                     | ➔ | 84063457                              | + | 84063462                       |
| P12C                | Z-30110-90                                     |   | 84063458                              |   | 84063463                       |
| P12D / P16A         | P-75110-31                                     |   | 84063459                              |   | 84063463                       |
| P12E / P20A         | A-22101-39                                     |   | 84063460                              |   | 84063464                       |
| P12ER / P16E / P21A | N-82662-81                                     |   | 84063461                              |   | 84063464                       |
| P20A / P21A SP      | Q-23101-11                                     |   | 84107953                              |   | 84107954                       |



*The former equipped Part Number cannot be ordered anymore !*



# Tirax 80

Specially designed and manufactured by Potain for pin-connection of Potain K masts, the Tirax 80 allows pins to be safely fitted and removed, silently and without effort.

Pins installed and removed in only five stages:

1. Engage the jaws on the gripping head
2. Tighten the jaws on the pin head
3. Pull the pin
4. Remove the pin
5. Open the jaws and remove the Tirax 80



## > Characteristics

- Portable tool consisting of a hydraulic cylinder with gripping jaws and a handle, ensuring safe transport.
- Compatible with
  - 50 mm (1.6 m mast),
  - 60 mm; (2 m mast) ,
  - 80 mm (2.45 m mast) pins.
- Portable hydraulic unit connected by sleeved hose,
- Uses special pins equipped with gripping heads.



## > Capacities

- Maximum traction: 21 t,
- Maximum operating pressure: 700 bar,
- Traction time per pin, 6 seconds approx.,
- Hydraulic unit supply: 400 V 50 Hz, 480 V 60 Hz,
- Hydraulic unit power: 1,5 kW.



## References

### Article

Complete Tirax

84118324



# 1.2m K masts

A new K mast offer 1.2m cross-section for MDT city cranes (up to MDT159) equipped with a 1.6m section towerhead, particularly suitable for installation in restricted areas.

A complete range ...

10m and 5m monoblock masts section. Up to 4 masts in the same tractor-trailer train

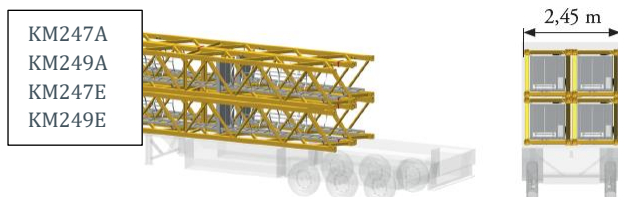

Inverted connecting mast K20/K40

Fixing angles

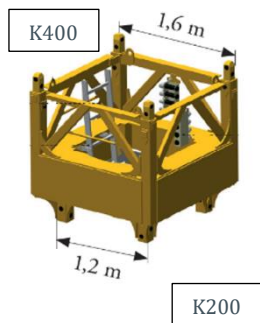

P23A/P41A

P24A/P42A

R24A/R42A

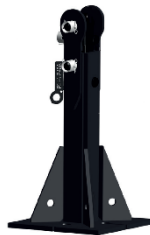

... to maximize the performance of you cranes

Example :

Hook heights  
MDT159 --> 45 m jib / C50

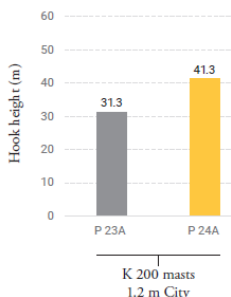

For confined spaces, such as elevator shafts, there is a short axis version in standard and tirax versions.

Mast pin sect



# Mast pins securing device and Pins remove tool

- Mast pins securing device (diameters 50/60/80 mm)



This lockable system prevents the risk of pins falling when the crane is dismantled.

- Anti-vibration tool to remove pins diameter 40 and 60 mm



The use of an unsuitable axle, spindle or tool creates a safety risk.



This system prevents the risk of hand crushing and vibration when the axles are difficult to remove.

**Other tools will soon be added to this safety equipments!**

### References

| Equipment for erectors and technicians |          |
|--|----------|
| Mast pins securing device              | 84103688 |
| Tool to remove pins diameter 40mm      | 84015112 |
| Tool to remove pins diameter 60mm      | 84015111 |





# Wedges for masts storage

Manitowoc offers you lightweight, rot-proof wedges to optimize and secure your masts in the yard.



The elastic band holds the wedge in place during mast handling.

The height of the wedge guarantees sufficient space to prevent hand injuries.

Made from recycled plastic, it's a safe alternative to wooden wedge.



### References

| Masts wedges              |          |
|---------------------------|----------|
| Mast wedge K 1.6m         | 84155242 |
| Mast wedge K 2m           | 84155222 |
| Floor wedge K 1.6m and 2m | 84155584 |



# PERIPHERICAL PRODUCTS



## Vision cabins POTAIN\*

*The original manufacturer cheaper than the adaptable!*



Cabin V140C



Cabin V140L



Cabin V140 SX

### > Major advantages

- **Original part: Safety, quality, durability...** It fully meets our requirements and allows optimal operation of your machine!
- **Manufacturer's warranty:** Guaranteed machine warranty, technical support, service and parts availability for a minimum of 10 years ... Work with peace of mind!
- **Cabin conforms to the EC standard: Security, electrification, and glazing.**

**Why take risks when safety is within reach?**

Offer the best for your crane at a competitive price!

*\*Different models available according to your crane type.*

Scan or click to access online support  
Or contact your usual Potain agent.





# Retrofit kit for Cab Visor

*for non-equipped Ultra View cabs*

The kit contains all the elements necessary for installation as well as an installation manual of a visor on the cab. It is not fitted for Ultra View cabs, already equipped with visor.

## > Characteristics

- Optimization of water flow
- Better visibility in rainy weather
- Durability (painted stainless steel visor)
- Easy installation
- Aesthetic: fits perfectly with the cab design

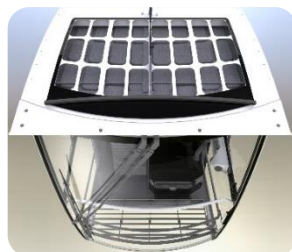

Degressive net price from 10 kits ordered !

## References

| Article       |                 |
|---------------|-----------------|
| Cab Visor kit | <b>84119773</b> |

Scan or click to access online support  
Or contact your usual Potain agent .



- Visb 08 22 EN



# Cab heating

*Winter is coming....*

Has your crane driver already complained about the poor condition of his cab heating? Don't wait for the breakdown and anticipate the request by installing a quality heating device right now !

## > Characteristics

- Specially selected for the crane cabs.
- Size : 253 x 253 x 164 mm.
- Weight : 5,5 kg.
- Low noise level: 50dB.
- Power: 2000 W.
- With ventilation function for the summer.
- Tridirectional heating.
- Robust metal housing.



### 3 position button

1. Ventilation (summer),
2. Heating and regulated ventilation,
3. Stop.



### Room thermostat control

## References

### Heater

Cab heater

**Q-15418-19**

Scan or click to access online support  
Or contact your usual Potain agent.





# Dialog Wind Anemometer

*Prevent the overturning of your cranes !*

Mandatory for the prevention of the risk of overturning of cranes under the effect of the wind, it is an essential safety element. Entirely digital, Dialog Wind is reliable and robust, and is certified by CETIAT.



## > Sensor

- Non-oxidizing tight bearings,
- Electronic card protected by double varnishing,
- Polyurethane cables with compound-filled connector link.

## > Indicator

- Adjusting of the alarm and prealarm thresholds by means of access code,
- Fixing by «non-slip» magnets,
- 4 button keypad with signal lamps + buzzer,
- Button for testing the correct working order,
- Choice of speed unit: km/h, m/s or miles/h
- Internal buzzer and display for fault signalling and identification.



## > Alarm block



- Adjustable luminous alarm frequency (5 W lamps),
- Programmable alarm bell (110 dB siren at 1 m),
- Fixing by «non-slip» magnets,
- Protecting by roller bar

## > Options

- Repeater: Additional display box (wire link, cable 60m)
- Radio repeater : For cranes with collector, we propose a solution with radio repeater, pack including: sensor + alarm block + main display + repeater display,
- Giant Vision display : see our SPN« [Giant display XXL](#) ».



# Dialog Wind Anemometer

## References

### Complete pack configured without Collector

|  |                   |
|--|-------------------|
| Sensor + alarm block + main display + cables | <b>H-68416-10</b> |
| Sensor (alone)                               | <b>J-68416-11</b> |
| Cup holder set (alone)                       | <b>Z-68416-25</b> |
| Display (alone)                              | <b>N-68416-15</b> |
| Alarm block (alone)                          | <b>P-68416-16</b> |

### Complete pack – Crane configured with Collector

|  |                   |
|--|-------------------|
| Sensor + alarm block + main display + repeater display | <b>F-71406-54</b> |
|--|-------------------|

### Options

|   |                   |
|---|-------------------|
| Repeater: Additional display box (wire link, cable 60m) | <b>Q-68416-17</b> |
|---|-------------------|

Scan or click to access online support  
Or contact your usual Potain agent .





# Giant display XXL

*For all types of cranes*

The Giant display XXL indicates the wind speed on a large LED screen

### > Characteristics

- Display composed of 3 digits of 7 segments of big size (100 mm height) + unit label
- Tightness : IP 65.
- Mains supply : 24VDC (19-36v).
- Temperature : -20 à +70°C.



### > Advantages

- Compatible with Potain Dialog Wind and any system using: 4-20 mA, 0-5 V and frequency anemometer sensor,
- Visible by all people on the site up to 50 meters,
- Limits the amplified danger of accidents during extreme weather conditions,
- Complying with European standards,
- Quality material, shock-proof and resistant to vibrations,
- No maintenance.

## References

|                                  |                   |
|----------------------------------|-------------------|
| <b>Not CCS Crane</b>             |                   |
| Giant display XXL                | <b>84002612</b>   |
| <b>CCS Crane</b>                 |                   |
| Giant display XXL                | <b>84042786</b>   |
| Power box                        | <b>84043689</b>   |
| Bottom crane display             | <b>Contact us</b> |
| <b>MR Refresh Cranes (MRxx8)</b> |                   |
| Giant display XXL                | <b>Contact us</b> |

Scan or click to access online support "Anemometer" associated :  
 Or contact your usual Potain agent







**NEW**

# Jobsite lighting for GME

*Improve the safety of your job sites with LED spotlights*

## > Characteristics

- Type LED spotlights - Reduced power consumption,
- Configuration On masts (photo no. 1) or/and on jib (photo no. 2).  
Folding for transport or telescoping position,
- Electrical power 300 W, 240 V,
- Lighting intensity 39,000 Lumens,
- Power supply 230 – 400 V,
- Control Single switch (at the bottom) or two-way switch (at top and bottom).

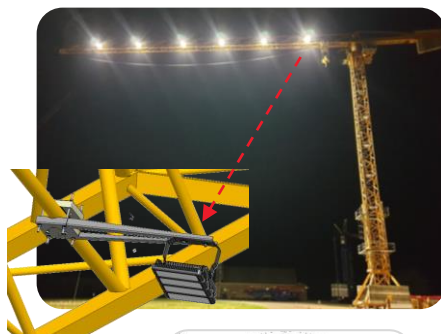

We can simulate the lighting of your job site by software to optimize the number of spotlights required.

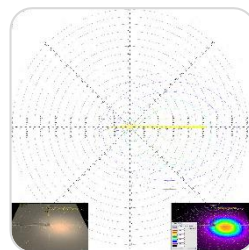

## > What about GMA cranes ?

Find our complete range (GME and GMA), all the models available and information concerning our product support





# Advertising lighting

*Improve the signage of your jobsites!*

Designed for cranes, palisades, facilities, bungalows....

## > Magnetic version

- Installation without screws and without drilling,
- No impact on wind resistance,
- Light, soft, flexible, thickness < 1 mm,
- Customizable sizes.

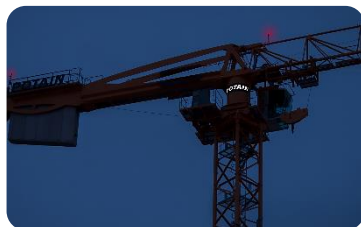

## > Plate version

- Quick and easy installation (screws and nuts),
- Wind resistance conforms with the crane's notices,
- Lightweight, less than 30 Kg,
- From 2,86 m<sup>2</sup> to 5m<sup>2</sup> customizable, for an installation on the counter-jib, depending on your crane type and your needs.



## > Tarpaulin version

- Light, soft, flexible,
- Customizable sizes,
- Fastening to all supports thanks to its rings.
- Use only on solid walls, not on crane masts



## > Advantages

- Light emitting technology: Power supply via 230V DC enclosure equipped with a programmable clock,
- 100% Made in France and 100% Customizable,
- Low power consumption: 3x less than LED technology,
- In compliance with the French standards on light pollution,
- 20,000-hour lifespan,
- Temperature range: - 30° to + 45° C.

- Ecpd 02 23 EN



# Driving Camera

*Improve the safety on your jobsite*

## > Characteristics



- Low consumption,
- 22x optical zoom, autofocus, wireless zoom pedal,
- Operating temperature: -30°C to + 65°C,
- Simple and quick assembly, no additional loading device,
- Insensitive to the wind and shocks and vibrations resistant.
- 3 years warranted

## > Trolley tower crane kit

- 10" or 13" screen,
- Solar pannel,
- Transmitter integrated,

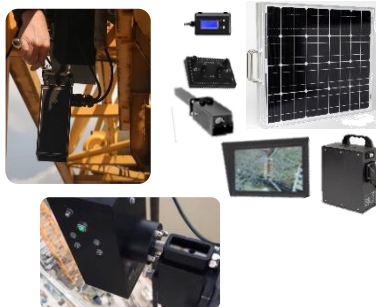

## > Luffing jib tower crane kit

- 10" or 13" screen,
- Electric tilt system: perfect image stability,
- 75m cable,



Delivered in its own protective suitcase !

**NEW**

## > Recorder

- 7 days recording duration on 128GB micro SD (supplied)
- preset to work with the camera
- quick installation



## References

| Driving camera kits                    |             |             |
|--|-------------|-------------|
|  | 10" Display | 13" Display |
| Trolley tower crane kit (MD/MDT Crane) | 84128766    | 84129678    |
| Luffing jib tower crane kit (MR Crane) | 84128781    | 84129679    |
| Recorder                               | 84136944    |             |



## CAB 'In

### *Internal crane-driver lifting equipment*



The internal crane-driver lifting equipment for Potain mast sections is compatible with all K mast sections.

#### > Characteristics

- Mast sections prefitted at the factory,
- Hoisting speed up to 24 m/min,
- Load capacity: 200 kg/ 2 person,
- Development in collaboration with the company GEDA,
- Option to retrofit the existing mast sections: contact us.

#### > Advantages

- Installation carried out at the same time as the crane and alongside the access ladders,
- No extra transport and storage costs,
- Optimal management of the mast section fleet, compatible with:
  - All K mast sections (1.6 m, 2 m and 2.45 m) with new and old access.
  - All current mast section bases (fixing angles, chassis and cross-shaped bases).

#### > Safety

- Arrival/departure platforms enclosure.
- Upper and lower sensors on the lift cab for safety when in use.
- 360° visibility from the crane-driver lifting equipment interior for inspecting the mast sections.
- Drive unit maintenance from the inside of the crane-driver
- Optional : Kit for acceptance of commissioning and periodic inspection.



**In France: in accordance with recommendation R.495. From January 1, 2019, motorized access is mandatory if the crane cab requires an ascent of more than 30 m.**

- Cablc 06 22 EN



# CCS Tool kit

## References

### CCS Tool kit

|   |                 |                           |                 |
|---|-----------------|---------------------------|-----------------|
| Complete CCS Tool kit (all articles under included) |                 |                           | <b>84054165</b> |
| Backpack (w/o tools)                                | <b>84054154</b> | Peack CAN cable           | <b>84016291</b> |
| Crimping tool harting                               | <b>84053003</b> | Connection cable          | <b>84018979</b> |
| Extraction tool                                     | <b>84024379</b> | Diagnostic cable          | <b>84010624</b> |
| Insertion tool                                      | <b>84053004</b> | Female contact harting    | <b>84006891</b> |
| Crimping tool SCM/CCT                               | <b>84053005</b> | Male contact harting      | <b>84006917</b> |
| Crimping die  | <b>84053008</b> | Socket CCS Display        | <b>03142169</b> |
| Extraction tool AMP MT                              | <b>04157406</b> | Contact CCS Display       | <b>80003367</b> |
| Extraction tool AMP JPT                             | <b>04157382</b> | AMP JPT Contact 0,5 - 1,0 | <b>03142253</b> |
| Screwdriver   | <b>84053011</b> | AMP MT Contact 1,0 - 2,5  | <b>03142436</b> |
| End   | <b>84053012</b> | AMP JPT Contact 1,0 - 2,5 | <b>03142435</b> |
| Tightening tool                                     | <b>84062863</b> | USB Stick                 | <b>84058247</b> |

Scan or click to access online support  
Or contact your usual Potain agent.





### CCS Tool kit

Cranes equipped of CCS technology require specific tools to realize maintenance.

To ensure you to have all the needed tools with you to realize the operation, we propose you a specific adapted backpack. Ergonomic and practical, it includes all essential tooling troubleshooting CCS cranes.

- Backpack - 1 PC
- Crimping tool harting - 1 PC
- Extraction tool - 1 PC
- Insertion tool - 1 PC
- Crimping tool SCM/CCT - 1 PC
- Crimping die - 1 PC
- Extraction tool AMP MT - 1 PC
- Extraction tool AMP JPT - 1 PC
- Screwdriver - 1 PC
- End - 1 PC
- Tightening tool - 1 PC
- Peack CAN cable - 1 PC
- Connection cable - 1 PC
- Diagnostic cable - 1 PC
- Female contact harting - 100 PC
- Male contact harting - 100 PC
- Socket CCS Display - 1 PC
- Contact CCS Display - 100 PC
- AMP JPT Contact 0,5 - 1,0 - 100 PC
- AMP MT Contact 1,0 - 2,5 - 100 PC
- AMP JPT Contact 1,0 - 2,5 - 100 PC
- USB Stick - 1 PC



*\* For further information on the content of this kit (tool details, references...), please refer to 'CCS Tools Catalogue' (available upon request)*





# Jib lifting beam

*Reinforce safety on your site*

Handling and shifting crane elements are delicate exercises which can cause accidents. To minimize the danger and to improve safety on your site, Potain proposes a jib lifting beam.



### > Characteristics

- Jib lifting beam for round bar of 40mm to 170 mm.
- Max. load per lifting beam: 17500daN.
- Weight per lifting beam: 30kg.

### > Advantages

Secures the slinging operation, especially for double tie bar lines.

The beam separates the chains allowing room for the tie bars to lift without catching the chains.

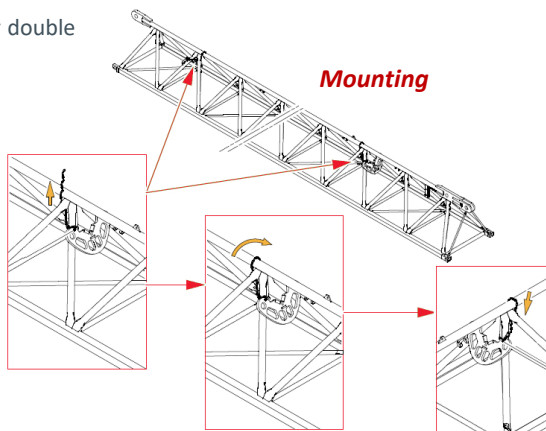

## References

| Article          |          |
|------------------|----------|
| Jib lifting beam | 84003496 |

- Pald 08 22EN



# Mast pins securing devices

## POTAIN is committed to safety!

- Mast pins securing device (diameters 50/60/80 mm)



This lockable system prevents the risk of pins falling when the crane is dismantled.

- Anti-vibration tool to remove pins diameter 40 and 60 mm



The use of an unsuitable axle, spindle or tool creates a safety risk.



This system prevents the risk of hand crushing and vibration when the axles are difficult to remove.

**Other tools will soon be added to this safety equipments!**

### References

| Equipment for erectors and technicians |          |
|--|----------|
| Mast pins securing device              | 84103688 |
| Tool to remove pins diameter 40mm      | 84015112 |
| Tool to remove pins diameter 60mm      | 84015111 |







# Remote Controls

Our remote controls are taking into account the features of each of the mechanisms of your cranes, either recent or old ones.

## > Characteristics

- Improve the productivity of your sites : driving from a distance,
- Better control of handling operations and better occupation of the staff,
- For optimum safety, systematic stop of movements in progress in case of interruption or loss of the radio link.

## > 4 Remote control ranges

Approved for every country and complying with the E.U. directives, there is different type of remote controls depending of the range :

- **PRB 1:** For small cranes (overhead travelling cranes).
- **PRC:** For range GMA (HDT and GTMR)
- **PRS or PRM:** For range GME (MD, MDT and MR)
- **V3 and CCS:** For ranges GMA and GME (Igo T, MCT and MDT)

Our remote controls can be supplied with or without indicator, at your choice.

## > Composition



*When the controls of a crane are through use of a component not authorized by the manufacturer, responsibility can not be accepted in case of damage caused "on" or "by" the crane.*



# Remote control accessories

## > CCS Transmitter protection cover



- Protection against scratches and dirt.
- Opening for battery.

## > Carrying harness



- More ergonomic than the classic belt.
- Reduce musculoskeletal disorders of the neck and back.
- Help to drive with more precision.
- Adjustable.
- Compatible with the following transmitters:



## References

| Articles                         |          |
|----------------------------------|----------|
| CCS transmitter protective cover | 84129220 |
| Carrying Harness                 | 84129221 |







## Jobsite communication equipment

*Reliable, high-performance solutions for staying connected*

### > Bluetooth Headphones







|   |                        |
|---|------------------------|
|  | Bluetooth connectivity |
|  | Lithium Battery 200mah |
|  | Recharge USB TYPE-C    |
|  | Autonomy 12H           |
|  | Protection class IP67  |

#### Clear sound, guaranteed safety:

With the innovative bone conduction technology, these headphones offer perfect communication and allow you to wear hearing protection.

### > Talkie-Walkie



|   |   |   |  |
|---|---|---|--|
|  |  |  |  |
| 500mW Power   | 10Km range  | Rechargeable NiMh Battery   | Autonomy 18H   |

#### For real communication between crane operators and slingers

Durable and practical, it will fit into any business context.

Emergency call button: automatically cuts off communications in favor of the walkie-talkie that made the call.

Surveillance function: lets you hear without being heard.

Kit composition :

- 2 transmitters - receivers
- 2 rechargeable NIMH battery
- 1 dual charger with 2 USB connections

### Jobsite communication equipment

|                     |          |
|---------------------|----------|
| Bluetooth Headphone | 84155576 |
| Talkie-Walkie       | 82005259 |



# New battery 2.75 Ah

*Up to 40% more capacity\**



This new battery fully complies with the original manufacturer's specifications covering of our whole range of cranes equipped with a NOVA transmitter or GL using the battery P-63418-95 or 84043425.

## > Characteristics

- Capacity : 2.75 Ah,
- Technology : Nickel –Metal Hydride (Ni-MH),
- Nominal voltage : 3.6V.

## > Advantages

- Up to 40% more capacity,
- A preferential tariff for a quantitative order,
- Compatible with the fast charger N-63418-94.



Only POTAIN batteries guarantee the correct operation of our transmitters. When using batteries sold elsewhere than in our network these can damage the electronics of our transmitters and in no case, we would be held responsible for the damage caused.

## References

Battery and charger

Battery 2.75 Ah

8408052



# SERVICES





# Document reissue

*For Potain GMA or GME cranes type\**

Systematically supplied with the new cranes, they also can be supplied on request for old crane models.

They are carried out in perfect accordance with the crane composition: Type, serial number, desired language, country where the crane operates, or wind standard used are necessary. Here is the list of the document that can be reprinting:

➤ **Complete set of manuals: Fitting + operation + spare parts**

- Paper version\*\*
- USB version\*\*
- Complementary reactions



➤ **EC certificate of conformity duplicate**

➤ **Neutral maintenance logbook**

*Useful when recording the maintenance operations.*

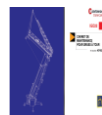

➤ **Red bag for set of manuals**

- For GME
- For GMA



*\*Subject to the availability of the translation in the requested language. This table only concerns records ordered after-sales, outside the sales channel of new cranes.*

*\*\*Also order one of these references if you need a crane inspection book (Kranprübuch) for Germany and Poland.*

## References

### Articles

|                              |                         |                     |
|------------------------------|-------------------------|---------------------|
| Complete Set                 | Paper version           | <b>E-62985-31**</b> |
|                              | USB version             | <b>84070396**</b>   |
|                              | Complementary reactions | <b>84143055</b>     |
| EC certificate of conformity |                         | <b>84118659</b>     |
| Neutral maintenance logbook  |                         | <b>V-85985-92</b>   |
| Red bag                      | For GME                 | <b>84121774</b>     |
|                              | For GMA                 | <b>84121775</b>     |





## Goodies

### Passionate about the POTAIN brand?

Find all our promotional items to offer a unique gift!



#### > Scale model

Estafette POTAIN: **84147165**

#### > Key rings

Technician's Van: **84152824**

POTAIN Logo: **84152825**

#### > Clothes

Men's Polo: 100% Organic cotton

| Size | S               | M               | L               | XL              | XXL             | XXXL            |
|------|-----------------|-----------------|-----------------|-----------------|-----------------|-----------------|
| P/N  | <b>84152833</b> | <b>84152834</b> | <b>84152835</b> | <b>84152836</b> | <b>84152837</b> | <b>84152838</b> |

#### > POTAIN Models



The presentation of our models is available via this QR Code





# Potain CONNECT+



## > Potain CONNECT+

With Potain CONNECT+, Make it easy to follow your fleet, real time, 24/7

- Improve the productivity
- Improve safety and environmental impact
- Develop your activity

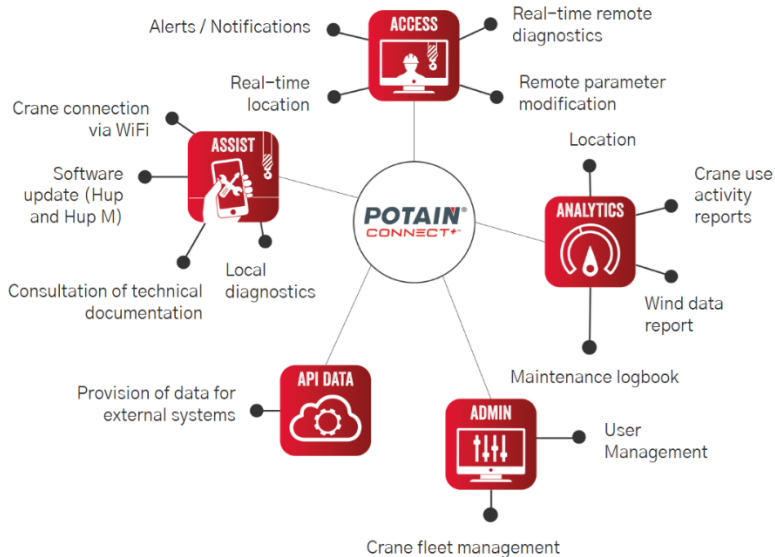

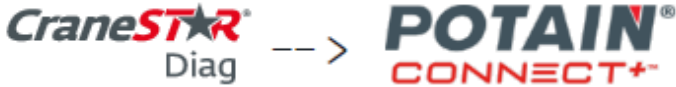

This solution is available for all your cranes CCS cranes, GME or GMA, and MRxx8.

**✓ Access to the web portal**

- ✓ Real-time geolocation
- ✓ Remote diagnostics
- ✓ Remote parameter modification
- ✓ Management of maintenance alerts and notifications



---

Reports:

- ✓ Maintenance notification + Maintenance plan
- ✓ Crane
- ✓ Configuration crane activity
- ✓ Wind
- ✓ Fault codes
- ✓ Transmission of reports/email



---

- ✓ Crane user and fleet management



---

- ✓ Integration of crane fleet data in any other ERP



**✓ Application on smartphone**

- ✓ Local diagnostics
- ✓ Software update (Hup and Hup M)
- ✓ Consultation of ex-works documentation + updates





For 3 years or more Potain CONNECT+ subscription (*CraneSTAR Diag running contract included*), the new **Potain CONNECT + modem is for free**.  
Installation takes only few minutes !

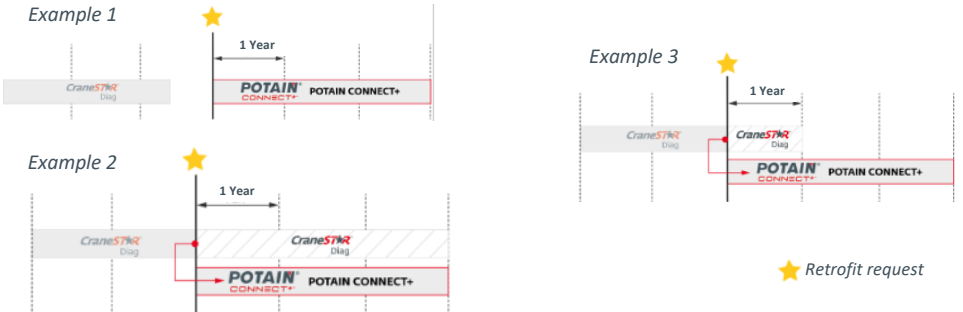



# Potain Gold offer

Reduce your costs and preserve the environment by choosing our offer « GOLD ».

- Reconditioned parts, tested and checked by our suppliers, guaranteeing you the same standards as a new part.
- Offer valid on a list of specific items, in limited quantities\*.
- Attractive price\*.
- 12 months warranty.

\* Contact us



Scan or click to access our genuine Part SPN,  
Or contact your usual Potain agent.



If you require more information, please contact your usual correspondent or contact us via e-mail address : [europower.parts@manitowoc.com](mailto:europower.parts@manitowoc.com) –

Non-contractual document, reproduction prohibited - Golc 12 22 EN



## « Standard Repair » motors

According to the motor type, Potain proposes 2 replacement solutions for a defective motor:

### > New Motors

- According to the specifications sheet of the original motors («first mounting»),
- Complying with the last technical developments in force,
- Large updated stock, immediately available.



### > « Standard Repair » motors

Before



After



- A perfect quality level, comparable to the new product,
- Complete dismantling and systematic checking of all components.
- Checking of the insulation, measurement of the leakage current and continuity test of the windings.
- Boring of the bearings, bleaching of the collector rings.
- Degreasing, cleaning, shot blasting, stoving or rewinding.
- Systematic replacement of all worn parts by original parts and bearings.
- Optimum balancing, quality grade: G.6,3.
- Final inspection without load and with load on a specific test bench.
- Complying with the last technical developments in force.
- Only one constraint: the defective motor must be returned within one month



We also propose a « Standard Repair » on gearbox and some frequency inverters.

Scan or click to access online support  
Or contact your usual Potain agent.



- Echf 06 22EN



# Training Academy Potain

*Improve and enhance the skills of your teams*

## > Skills and knowledge of your team

The skills and knowledge of men and women in the field are essential to the performance and sustainability of a construction company.



Aware that knowledge of assembly, troubleshooting and the tools inherent in the use of a crane is of great importance for technicians working on construction sites, Potain also offers to train your teams in the various crane trades.

The Potain training center has been created in 1970 on its historic site of La Clayette. From now on called Potain Academy, the center is now located near Lyon, in St Pierre de Chandieu, on the same site as the spare parts stores.

## > The Academy

Equipped with 5 permanently mounted Potain cranes (3 GMA and 2 GME), the Potain Academy offers training in crane driving, assembly, or repairs, for its customers and Potain dealers.

Periodically, the Academy receives new models for a shorter duration to provide new product training to dealers purchasing their first crane.



If you want more information, don't hesitate to see the Academy's brochure, on our website, or scan the QR Code:

[Potain Academy EN](#)





## Regional headquarters

### Americas

Milwaukee, Wisconsin,  
USA  
Tel: +1 414 760 4600

### Europe and Africa

Dardilly, France - TOWERS  
Tel: +33 4 7218 20 20

### APAC

Shanghai, China  
Tel: +86 21 6457 0066

### Middle East and India

Dubai, UAE  
Tel: +971 4 8862677

Shady Grove,  
Pennsylvania, USA  
Tel: +1 717 597 8121

Wilhelmshaven,  
Germany - MOBILE  
Tel: +49 (0) 4421 294 0

Singapore  
Tel: +65 6264 1188

This document is non-contractual. Constant improvement and engineering progress make it necessary that we reserve the right to make specification, equipment, and price changes without notice. Illustrations shown may include optional equipment and accessories and may not include all standard equipment.



[www.manitowoc.com](http://www.manitowoc.com)