

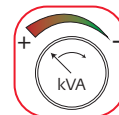

Power Control

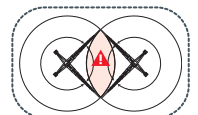



Anti-collision system



Mât - Réactions / Mast - Reaktionskräfte / Mast - Reactions / Mástil - Reacciones / Torre - Reazioni
 Tramo - Reacções / Реакция опор мачты

2,45 m - P 800B - C25					
ΔΔΔΔ (m)	30	40	50	60	
↓ (m)	60,6	57,3	52,3	49	
	3,33 m	1	0	0	2
	5 m	11	11	10	8
F2 (t)	●	280	292	300	301
	■	365	390	369	410
F3 (t)	●	195	204	211	212
	■	281	303	280	321
↓ (m) D25	57,3	52,3	47,3	40,6	

2,45 m - P 854A - C25					
ΔΔΔΔ (m)	30	40	50	60	
↓ (m)	75,6	70,6	67,3	60,6	
	3,33 m	1	1	0	1
	5 m	14	13	13	11
F2 (t)	●	329	335	348	338
	■	575	576	597	591
F3 (t)	●	232	238	248	241
	■	479	478	497	495
↓ (m) D25	65,6	59	55,6	49	

2,45 m - JM 850 - C25					
ΔΔΔΔ (m)	30	40	50	60	
↓ (m)	76,4	74,7	71,4	66,4	
	3,33 m	0	1	0	0
	5 m	13	12	12	11
F1 (t)	●	157	180	181	182
	■	213	244	247	254
↓ (m) D25	71,4	66,4	61,4	53,1	

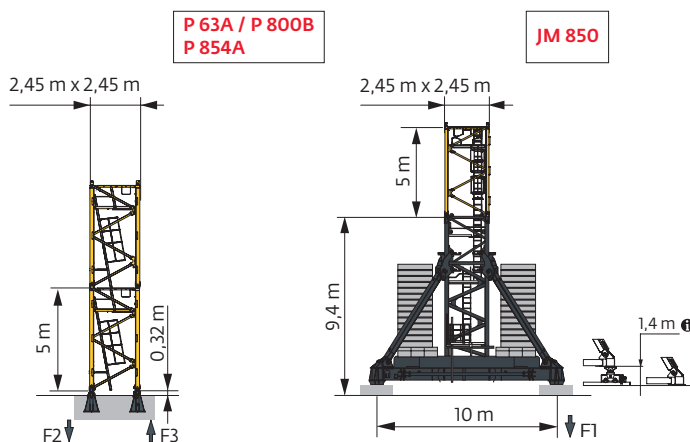

i Autres compositions de pylône - Nous consulter. / Andere Turmaufbauten - bitte kontaktieren Sie uns. / Other mast compositions - Please consult us. / Para otras composiciones de mástil - Por favor contactenos. / Per altre composizioni torre, contattateci. / Para outras composições de coluna - Por favor, consulte-nos. / Для других композиций мачты пожалуйста консультируйтесь с нами.

Accès motorisés : compositions de mât, de lest de base et réactions adaptées. / Motorisierter Zugang vom : Mastzusammensetzung, Grundballast und Reaktionskräfte sind angepasst. / Motorized accesses: adapted mast composition, base ballast and reactions. / Acceso a cabina con elevador: Adaptación de composición de mástil, lastre de base y reacciones. / Accessi motorizzati: composizioni elementi torre, zavorre di base e reazioni aggiornate. / Acessos motorizados: composições de coluna, lastro da base e reacções adaptadas. / Лифты : адаптированная композиция мачты, базовый балласт и нагрузки.

2,45 m - ZY 800 - C25

▽\△\△ (m)	30	40	50	60
↑ (m)	45,3	35,3	35,3	37
3,33 m	2	2	2	1
5 m	7	5	5	6
Fl (t)	● 129	125	135	141
	■ 104	99	100	126
↑ (m) D25	45,3	35,3	35,3	37

2,45 m - ZY 854 - C25

▽\△\△ (m)	30	40	50	60
↑ (m)	73,9	67,3	58,9	53,9
3,33 m	0	1	0	0
5 m	14	12	11	10
Fl (t)	● 199	202	186	189
	■ 277	264	236	248
↑ (m) D25	58,9	53,9	48,9	43,9

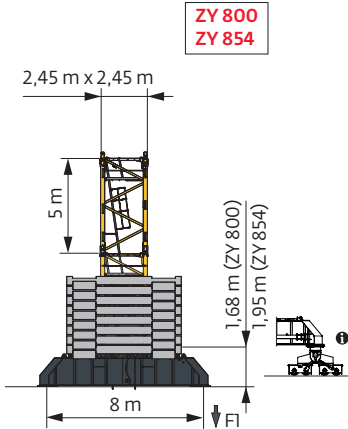

Ancrages / Verankerungen / Anchorages / Anclajes / Ancoraggi
Ancoragem / нкера

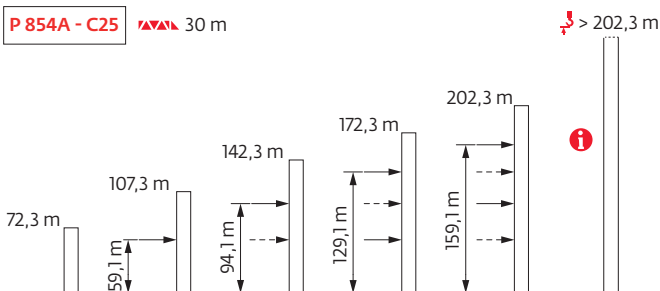
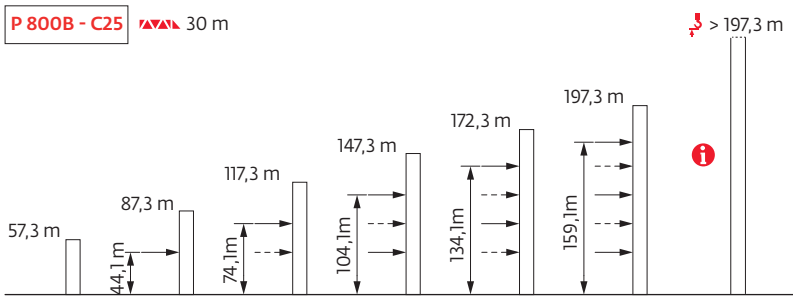

Lest de base / Grundballast / Base ballast / Lastre de base / Zavorra di base
 Lastro da base / Базовый Балласт

⚖️ (t) / 📏 2,45 m - JM 850 - 🏗️ - C25

📏 (m)	30	40	50	60
76,4	144			
74,7	132	192		
71,4	108	144	204	
66,4	72	108	156	216
61,4	48	72	108	168
56,4	48	48	72	132
51,4	48	48	48	96
46,4	48	48	48	48
41,4	48	48	48	48
36,4	48	48	48	48
31,4	48	48	48	48
26,4	48	48	48	48

⚖️ (t) / 📏 2,45 m - ZY 800 - 🏗️ - C25

📏 (m)	30	40	50	60
45,3	72			
37	60			72
35,3	60	60	60	72
30,3	60	60	48	60
25,3	48	60	48	48

⚖️ (t) / 📏 2,45 m - ZY 854 - 🏗️ - C25





📏 (m)	30	40	50	60
73,9	216			
67,3	156	216		
58,9	84	132	180	
53,9	84	72	144	204
48,9	72	72	72	144
43,9	60	60	60	96
38,9	60	48	48	72
33,9	48	48	48	60
28,9	48	48	36	48
23,9	48	48	36	36

Courbes de charges / Lastkurven / Load curves / Curvas de cargas / Curve di carico
 Curvas de carga / Кривые нагрузок

📏 (m)	20	22	25	27	30	32	35	37	40	42	45	47	50	52	55	57	60	m
📏 16 t	↓																	
60	6,7 → 34,5	16	16	16	16	16	15,7	14,8	13,5	12,7	11,7	11,1	10,3	9,9	9,2	8,8	8,25	t
50	5,8 → 40	16	16	16	16	16	16	16	16	15,3	14,1	13,4	12,5	t				
40	4,9 → 40	16	16	16	16	16	16	16	16	t								
30	4 → 30	16	16	16	16	16	t											

📏 (m)	20	22	25	27	30	32	35	37	40	42	45	47	50	m	
📏 32 t	↓														
50	5,8 → 28,2	24	24	24	24	22,4	20,8	18,7	17,6	16	15,1	13,9	13,2	12,25	t
40	4,9 → 22,2	32	32	28,1	25,8	23	21,4	19,3	18,1	16,5	t				
30	4 → 21,8	32	31,7	27,6	25,3	22,5	t								

Poids de flèche & lest de contre-flèche / Auslegergewicht & Gegenauslegerballast / Jib weight & counter-jib ballast
 Peso de flecha y lastre de contra-flecha / Peso del braccio & zavorra di contro-braccio / Peso da lança & lastro da contra-lança
 Вес стрелы и балласт контр-стрелы

	 (kg) (+/- 5%)	 6000 kg	 (kg)
60 m	16975	10	60000
50 m	15405	10	60000
40 m	13485	9	54000
30 m	11070	8	48000

6000 kg

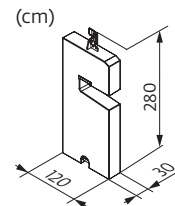

Flèche relevée / Ausleger in Steilstellung / Luffing jib / Flecha izada / Braccio impennato
 Lança inclinada / Маховая стрела

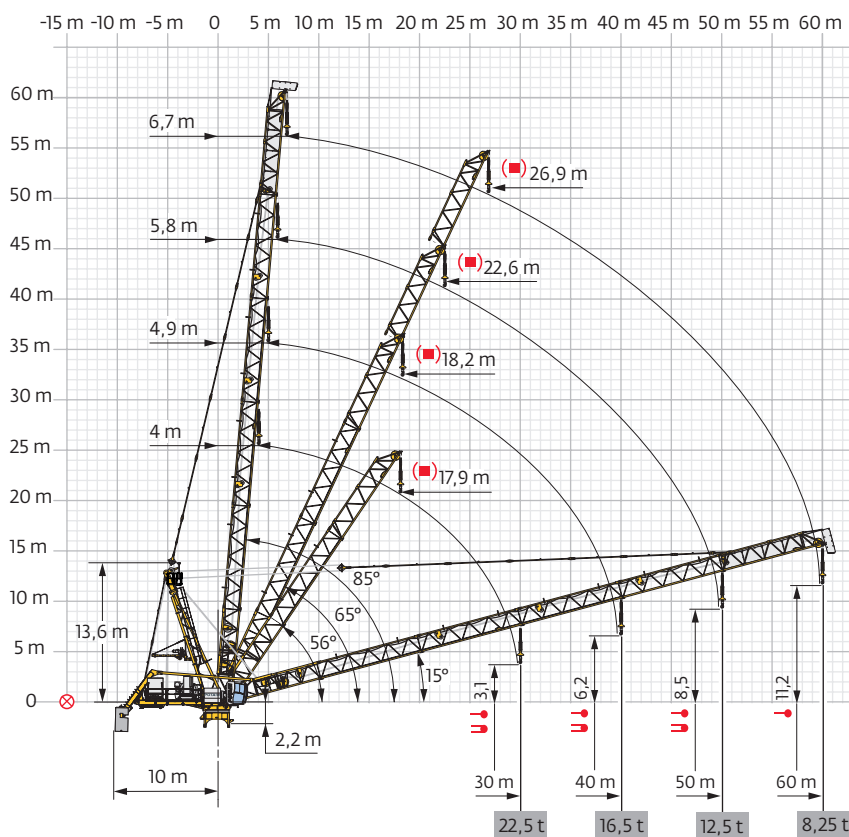







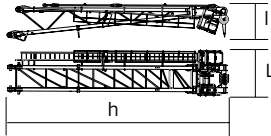
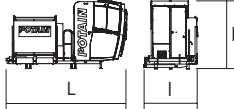
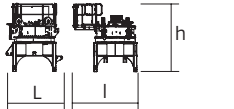
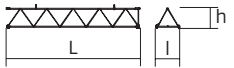
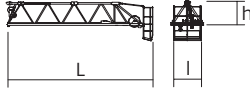
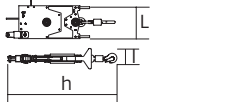
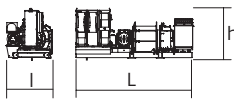
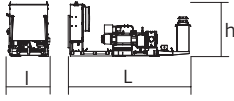
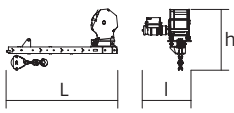
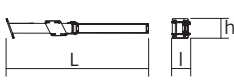
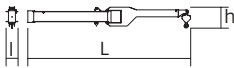
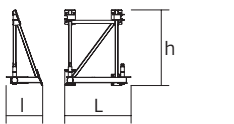

Encombrenment et poids / Abmessungen und Gewicht / Dimensions and weight / Dimensiones y peso / Ingombro e peso dimensões e pesos / габаритные размеры и вес

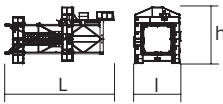
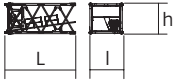
Partie tournante / Drehender Kranteil / Slewing crane part / Parte giratoria

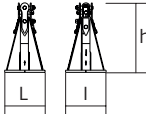
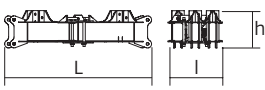
Parte rotante / Parte rotativa / Поворотная часть :   60 m -  270 LVF

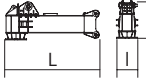

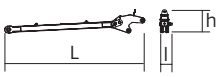
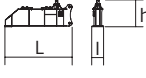
Partie tournante / Drehender Kranteil / Slewing crane part / Parte giratoria / Parte rotante Parte rotativa / Поворотная часть	L (m)	l (m)	h (m)	kg (+/- 5%)		
Contre-flèche (+ rambarde + plate-forme) Gegenausleger (+ Geländer + Plattform) Counter-jib (+ Grab rail + Platform) Contra-flecha (+ Guardacuerpos + Plataforma) Controbraccio (+ Parapetto + Piattaforma) / Contra-lança (+ Barreira + Plataforma) / Контр-стрела (+ Перила + Платформа)		7,02	6,37	2,31	10460	
Poinçon / Auslegerhaltebock Strut / Puntal Puntone / Extrator стойка		2,86	2,36	13,95	11245	
Cabine / Kabine Cab / Cabina Cabina / Cabina Кабина	 Ultra View	4,52	1,97	2,55	1715	
Pivot / Krankopf Towerhead / Pivote Portaralla / Pivot Секция поворотной части	 ∇ 2,45 m	3,24	3,62	3,35	12180	
Elément de flèche / Auslegerelement Jib section / Elemento de flecha Elemento di braccio / Elemento de lança Секция стрелы		①	9,6	1,9	1,83	3810
		②	10,57	1,9	1,83	1970
		③	10,57	1,9	1,83	2045
		④	10,57	1,9	1,83	1845
		⑤	10,57	1,9	1,83	1515
Elément de flèche / Auslegerelement Jib section / Elemento de flecha Elemento di braccio / Elemento de lança Секция стрелы	 ⑥	11,35	1,9	2,88	3360	
Moufle / Hubflasche Pulley block / Aparejo Bozzello / Cadernal Полиспаст		1,04	0,65	3,3	1595	
Treuil de levage (+ câble) / Hubwerk (+ Seil) Hoisting winch (+ rope) / Mecanismo de elevación (+ cabo) Argano di sollevamento (+ fune) Guincho de elevação (+ cabo) Подъемная лебедка (+ канатом)	 270 LVF	5,62	2,18	2,37	13920	
Treuil de levage (+ câble) / Auslegerverstellwerk (+ Seil) Luffing winch (+ rope) / Mecanismo de izado (+ cabo) Argano di Impennaggio braccio (+ fune) Mecanismo de Inclinação da Lança (+ cabo) лебедка подъема стрелы (+ канатом)	 150 VVF	4,88	1,72	2,17	5250	
Bras de potence arrière gauche (+ treuil auxiliaire + moufle) Hinterer linker Hilfspalgenarm + Hilfstriebwerk + Hubflasche Rear left derrick arm (+ auxiliary winch + pulley block)/Brazo de plumín trasero izquierdo + cabrestante auxiliar + aparejo Braccio della mensola posteriore sinistro + argano ausiliario + bozzello/Braço de potência traseiro esquerdo + guincho auxiliar + cadernal/Траверса кронштейна (задняя левая) + дополнительный подъемник + полиспаст		2,38	1,05	1,3	615	
Bras de potence avant gauche/Vorderer linker Hilfspalgenarm Front left derrick arm/Brazo de plumín delantero izquierdo/ Braccio della mensola anteriore sinistro/Braço de potência dianteiro esquerdo/Траверса кронштейна (передняя левая)		3,49	0,44	0,48	190	
Bras articulé de potence/Gelenkiger Hilfspalgenarm/Articulated derrick arm/Brazo de plumín articulado/Braccio articolato della mensola/Braço articulado de potência/ Подвижная траверса кронштейна		4,21	0,3	0,54	315	
Support de potence / Hilfspalgenträger / Derrick support Soporte de plumín / Supporto della mensola / Suporte de potência / Опора кронштейна		1,99	1,09	2,27	670	

Рулоне / Kranturm / Crane tower Mástil / Torre / Torre Башня крана		L (m)	l (m)	h (m)	kg (+/- 5%)	
T 851		2,45 m	11,18	4,84	5,8	15750
K 85/KR 84B2 KRM 849B KM 850.10B KM 850.14B K 85/KR 84A2 KR 849A KMT 849A KRMT 849A KMT 850.10A KMT 850.14A		2,45 m	10,24 10,24 10,32 10,32 5,24 5,23 5,23 5,23 5,32 5,32	2,54 2,55 2,54 2,54 2,54 2,53 2,55 2,55 2,54 2,54	2,5 2,53 2,51 2,51 2,5 2,5 2,53 2,53 2,51 2,51	9635 7800 10070 11190 5550 4290 3150 4090 5450 5990
KRMT 849C		2,45 m	3,57	2,55	2,53	3205
Pieds de scellement / VerankerungsfüÙe Fixing angles / Pie de empotramiento Montante da anegare / Angulos fixadores анкера		P 63A / P 800B P 854A	0,75 0,9	0,75 0,9	1,28 1,5	465 940
Croix centrale (position transport) / Zentralkreuz (Transport- position) / Central cross (transport position) / Brazo central (posición transporte) / Croce centrale (posizione di trasporto) Braço central chassis (posição transporte) / крестообразное основание (транспортное положение)		JM 850	5,2	1,7	1,5	6700
Mât-châssis / Grundmasteinheit Basic mast unit / Tramo-chasis Elemento base / Tramo-chassis Мачта для крепления к шасси		JM 850	8,75	2,5	2,5	14600
Bras de châssis / Unterwagenträger / Chassis girder / Brazo de base en cruz / Traverse del carro / Braço de chassis / опорная балка шасси		JM 850	5,2	0,9	1,55	3200
Tirant de châssis / Unterwagenstreben / Chassis ties / Tirante de base en cruz / Tiranti del carro / Tirante de chassis / тяга крепления шасси		JM 850	7,2	0,25	0,35	250
Haubans / Mastabstützungen Struts / Tornapuntas Puntoni / Escoras Растяжка		JM 850	8,2	0,75	1,3	2300
1/2 Bras de croix / 1/2 Fundamentkreuzträger 1/2 Cross girder / 1/2 Brazo en cruz 1/2 Braccio croce / 1/2 Braço da cruz 1/2 Поперечная балка		ZY 800 ZY 854	5,68 5,7	0,98 0,98	1,92 2,27	4720 6430
Bras de croix / Fundamentkreuzträger Cross girder / Brazo en cruz / Braccio croce / Braço da cruz Поперечная балка		ZY 800 ZY 854	11,96 11,9	1,39 1,42	1,92 2,27	10075 14000

Mécanismes / Triebwerke / Mechanisms / Mecanismos / Meccanismi
 Mecanismos / Механизмы

400 V - 50 Hz													ch - PS hp	kW	
	270 LVF 160 Optima	m/min t	63 16	82 12	116 8	174 4,5	216 2	32 32	41 24	58 16	87 10,3	108 5,6	270	200	541 m
	150 VVF 87		2 min 05 s									150	110		
	RVF 173 Optima +	tr/min U/min rpm	0 → 1									3 x 10	3 x 7,5		

IEC 60204-32	kVA
400 V (+10% -10%) 50 Hz	270 LVF + 150 VVF : 365 → 197 kVA

	FR	DE	EN	ES	IT	PT	RU
	Profil de vent suivant EN 14439 C25-D25	Windbedingungen gemäss EN 14439 C25-D25	Wind conditions according to EN 14439 C25-D25	Conformidad de los condiciones de viento EN 14439 C25-D25	Condizioni del vento secondo EN 14439 C25-D25	Perfil de vento conforme EN 14439 C25-D25	Ветровой режим в соответствии с EN 14439 C25-D25
	Équipements standards	Standardausrüstungen	Standard equipment	Equipamiento de serie	Equipaggiamento standard	Equipamento de série	Стандартное оборудование
	Équipements optionnels	Sonderausrüstungen	Options	Equipamiento opcional	Equipaggiamento in opzione	Equipamento opcional	Дополнительное оборудование (опция)
	Réactions en service	Reaktionskräfte in Betrieb	Reactions in service	Reacciones en servicio	Reazioni in servizio	Reacções em serviço	Реакция при работе
	Réactions hors service	Reaktionskräfte außer Betrieb	Reactions out of service	Reacciones fuera de servicio	Reazioni fuori servizio	Reacções fora de serviço	Реакция в покое
	Poids de flèche	Auslegergewicht	Jib weight	Peso de flecha	Peso del braccio	Peso da lança	вес стрелы
	Poids total du last	Ballast-Gesamtgewicht	Total ballast weight	Peso total del lastre	Peso totale della zavorra	Peso total do lastro	Общий вес балласта
	Axe articulation flèche	Auslegergelenk-achse	Jib articulation axis	Eje de articulación de la flecha	Perno di articolazione del braccio	Eixo de articulação da lança	Ось шарнира стрелы
	Position girouette	Windfreistellung	Weathervaning position	Posición veleta	Libera rotazione	Posição em cata-vento	Флюгер
	Camion 13,4 m	Lkw 13,4 m	Lorry 13,4 m	Camión 13,4 m	Camion 13,4 m	Camião 13,4 m	Рзуповой автомобиль 13,4 м
	Conteneur High Cube 40', et/ou Flat Rack 20'	Container High Cube 40', and/or Flat Rack 20'	Container High Cube 40', and/or Flat Rack 20'	Contenedor High Cube 40', y/o Flat Rack 20'	Container High Cube 40', e/o Flat Rack 20'	Contentor High Cube 40', e/ou Flat Rack 20'	40-футовый контейнер повышенной вместимости High Cube, и/или 20-футовая открытая платформа Flat Rack
	Cadre d'ancrage serré	Fester Verankerungsrahmen	Tightened anchorage frame	Marco de anclaje de apriete	Quadro di ancoraggio stretto	Quadro de amarração apertado	Прикрепленная анкерная рама
	Cadre d'ancrage desserré	Looser Verankerungsrahmen	Loosened anchorage frame	Marco de anclaje de desapriete	Quadro di ancoraggio allentato	Quadro de amarração solto	Отсоединенная анкерная рама
	Levage	Heben	Hoisting	Elevación	Sollevamento	Elevação	Подъем
	Relevage	AL-Verstellen	Luffing	Izado	Brandeggio	Levantamento	Маховый подъем
	Orientation	Schwenken	Slewing	Orientación	Rotazione	Rotação	Поворот
	Translation	Kranfahren	Travelling	Traslación	Traslazione	Tranlação	Перемещение крана
	Puissance requise	Erforderliche Leistung	Required power	Potencia Necesaria	Potenza richiesta	Potência Necessária	Потребляемая мощность
	Fonction Power Control : vitesses treuils adaptées à la puissance disponible	Funktion Power Control: Geschwindigkeiten der Triebwerke werden an die verfügbare Leistung angepasst	Power Control Function: winch speeds adapted to the available power	Función Power Control: marchas de los cabrestantes adaptadas a la potencia disponible	Funzione Power Control: velocità degli argani adattate alla potenza disponibile	Função Power Control: velocidades de guincho adaptadas à potência disponível	Функция контроля мощности Power Control: регулировка скорости лебедок в зависимости от доступной мощности
	Nous consulter	Auf Anfrage	Consult us	Consultarnos	Consultateci	Consultar-nos	Проконсультируйтесь у нас
	Document commercial non contractuel. Pour toute information technique se référer à la notice correspondante.	Unverbindliches Vertriebsdokument. Für technische Informationen, siehe die entsprechenden Anweisungen.	This commercial document is not legally binding. For any technical information, please refer to the corresponding instructions.	Documento comercial no contractual. Para cualquier información técnica, ver la noticia correspondiente.	Documento commerciale non vincolante, per tutte le informazioni tecniche fare riferimento al catalogo istruzioni.	Documento comercial não contractual. Para qualquer informação técnica complementar consultar as respectivas instruções.	Этот коммерческий документ не является юридически обязательным. Для получения технической информации, см. соответствующие инструкции.

