

MDT 189

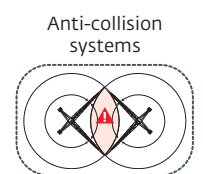
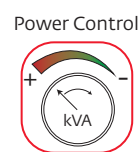
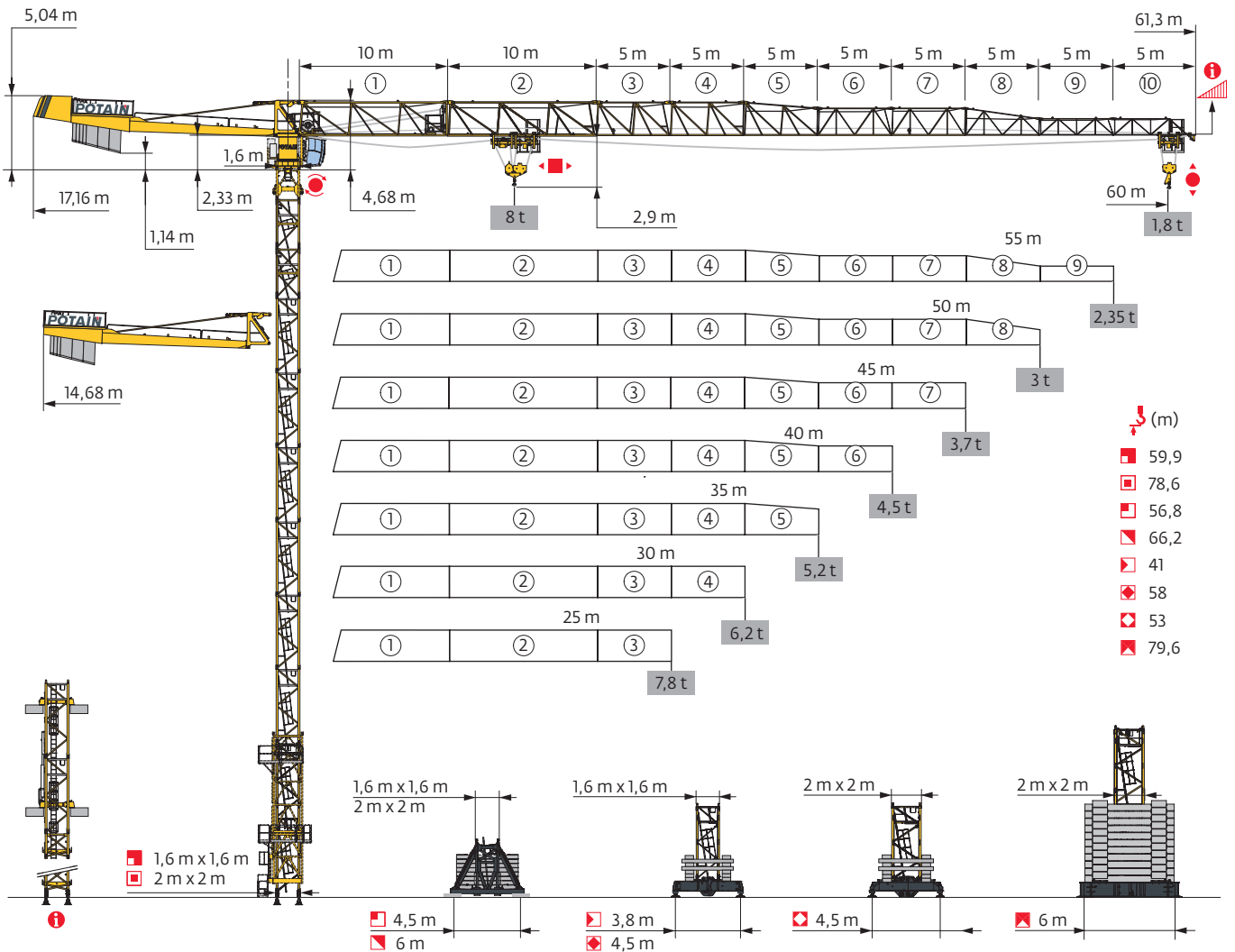

Mât - Réactions / Mast - Reaktionskräfte / Mast - Reactions / Mástil - Reacciones / Torre - Reazioni
 Tramo - Reacções / Реакция опор мачты

1,6 m City - P 42A

AVAIL (m)	25	30	35	40	45	50	55	60
(m)	59,9	59,9	59,9	59,9	59,9	59,9	59,9	58,3
/ P_{+} (m)	58,3	58,3	58,3	58,3	56,6	58,3	59,9	58,3
	3,33 m	0	0	0	0	0	0	1
	5 m	10	10	10	10	10	10	9
	10 m	1	1	1	1	1	1	1
F2 (t)	● 135	134	133	135	136	142	144	142
	■ 179	183	183	184	185	191	190	188
F3 (t)	● 103	102	101	102	103	108	109	107
	■ 152	155	155	155	155	161	159	158

1,6 m City - ZC 4230 -

AVAIL (m)	25	30	35	40	45	50	55	60
(m)	41	41	41	41	41	41	41	41
/ P_{+} (m)	37,7	39,4	39,4	37,7	37,7	39,4	41	41
	3,33 m	0	0	0	0	0	0	0
	5 m	8	8	8	8	8	8	8
	F1 (t)	● 70	68	67	67	68	68	70
	■ 61	61	60	60	61	62	63	64

1,6 m City - ZD 4230 -

AVAIL (m)	25	30	35	40	45	50	55	60
(m)	51	51	51	51	51	51	51	49,4
/ P_{+} (m)	49,4	51	51	51	51	51	51	49,4
	3,33 m	0	0	0	0	0	0	1
	5 m	10	10	10	10	10	10	9
	F1 (t)	● 68	70	70	71	71	73	72
	■ 76	78	78	78	79	82	82	81

1,6 m - P 42A

AVAIL (m)	25	30	35	40	45	50	55	60
(m)	58,6	58,6	58,6	56,9	56,9	56,9	56,9	55,3
/ P_{+} (m)	58,6	58,6	58,6	56,9	56,9	56,9	56,9	55,3
	2 m	1	1	1	1	1	1	1
	3,33 m	2	2	2	0	0	0	1
	5 m	8	8	8	9	9	9	8
	10 m	1	1	1	1	1	1	1
	F2 (t)	● 139	139	138	136	138	142	140
	■ 189	193	194	180	182	187	186	184
F3 (t)	● 107	107	105	103	104	108	106	104
	■ 162	165	165	152	152	157	156	154

1,6 m - S 41A -

AVAIL (m)	25	30	35	40	45	50	55	60
(m)	56,8	55,1	55,1	55,1	56,8	55,1	55,1	55,1
/ P_{+} (m)	56,8	55,1	55,1	55,1	56,8	55,1	55,1	55,1
	2 m	1	1	1	1	1	1	1
	3,33 m	2	0	0	0	2	0	0
	5 m	9	10	10	10	9	10	10
F1 (t)	● 85	81	81	82	86	85	84	86
	■ 108	101	101	101	111	106	105	109

1,6 m - ZD 463 -

AVAIL (m)	25	30	35	40	45	50	55	60
(m)	58	56,4	56,4	56,4	56,4	54,7	54,7	54,7
/ P_{+} (m)	58	56,4	56,4	56,4	56,4	54,7	54,7	54,7
	2 m	1	1	1	1	1	1	1
	3,33 m	0	1	1	1	1	2	2
	5 m	11	10	10	10	10	9	9
F1 (t)	● 88	85	85	86	87	86	85	87
	■ 112	109	109	109	110	108	107	111

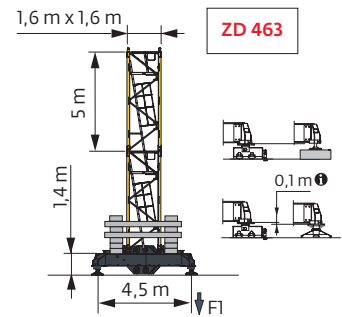
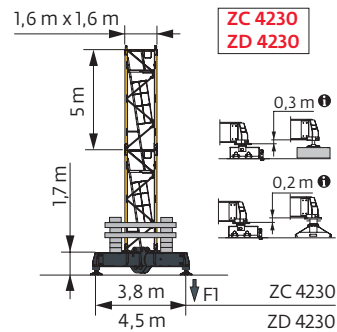
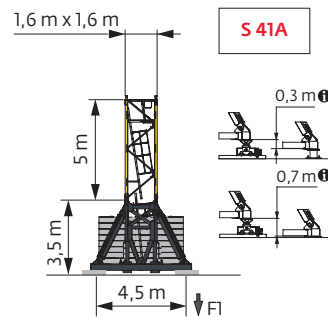
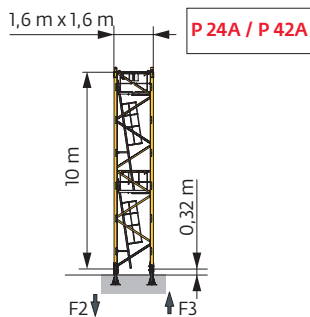

i Autres compositions de pylône - Nous consulter. / Andere Turmaufbauten - bitte kontaktieren Sie uns. / Other mast compositions - Please consult us. / Para otras composiciones de mástil - Por favor contáctenos. / Per altre composizioni torre, contattateci. / Para outras composições de coluna - Por favor, consulte-nos. / Для других композиций мачты пожалуйста консультируйтесь с нами.

Accès motorisés : compositions de mât, de lest de base et réactions adaptées. / Motorisierter Zugang vom : Mastzusammensetzung, Grundballast und Reaktionskräfte sind angepasst. / Motorized accesses: adapted mast composition, base ballast and reactions. / Acceso a cabina con elevador: Adaptación de composición de mástil, lastre de base y reacciones. / Accessi motorizzati: composizioni elementi torre, zavorre di base e reazioni aggiornate. / Acessos motorizados: composições de coluna, lastro da base e reacções adaptadas. / Лифты : адаптированная композиция мачты, базовый балласт и нагрузки.

2 m - P 63A

ΔΔΔΔ (m)	25	30	35	40	45	50	55	60
↓ (m)	78,6	78,6	78,6	78,6	78,6	76,9	76,9	76,9
↓/P+ (m)	78,6	78,6	78,6	78,6	78,6	76,9	76,9	76,9
	2 m	1	1	1	1	1	1	1
	3,33 m	2	2	2	2	0	0	0
	5 m	12	12	12	12	13	13	13
	10 m	1	1	1	1	1	1	1
F2 (t)	● 165	165	165	167	169	170	169	171
	■ 317	320	321	322	323	313	312	317
F3 (t)	● 125	124	123	125	126	127	126	127
	■ 281	284	284	284	284	274	273	278

2 m - V 60A -

ΔΔΔΔ (m)	25	30	35	40	45	50	55	60
↓ (m)	66,2	66,2	66,2	66,2	66,2	66,2	66,2	66,2
↓/P+ (m)	66,2	66,2	66,2	66,2	66,2	66,2	66,2	66,2
	2 m	1	1	1	1	1	1	1
	3,33 m	0	0	0	0	0	0	0
	5 m	12	12	12	12	12	12	12
	F1 (t)	● 89	89	90	90	91	93	93
	■ 131	133	133	133	134	137	136	139

2 m - ZD 463 -

ΔΔΔΔ (m)	25	30	35	40	45	50	55	60
↓ (m)	53	53	53	53	53	53	53	53
↓/P+ (m)	53	53	53	53	53	53	53	53
	2 m	1	1	1	1	1	1	1
	3,33 m	0	0	0	0	0	0	0
	5 m	10	10	10	10	10	10	10
	F1 (t)	● 86	88	88	87	88	90	90
	■ 112	115	115	115	115	119	119	123

2 m - ZX 640 -

ΔΔΔΔ (m)	25	30	35	40	45	50	55	60
↓ (m)	79,6	79,6	79,6	79,6	79,6	77,9	77,9	77,9
↓/P+ (m)	79,6	79,6	79,6	79,6	79,6	77,9	77,9	77,9
	2 m	1	1	1	1	1	1	1
	3,33 m	2	2	2	2	0	0	0
	5 m	12	12	12	12	12	13	13
	10 m	1	1	1	1	1	1	1
F1 (t)	● 124	124	124	125	126	124	124	124
	■ 192	194	194	194	194	188	188	191

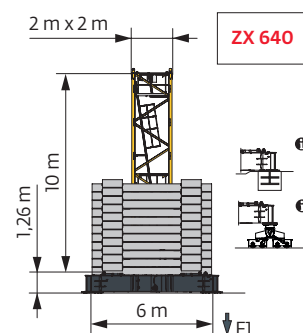
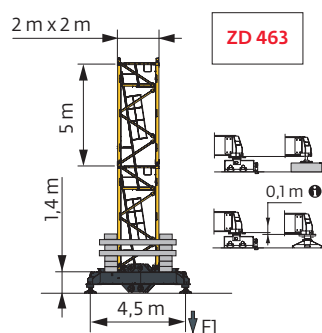
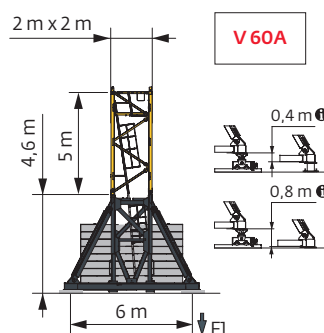
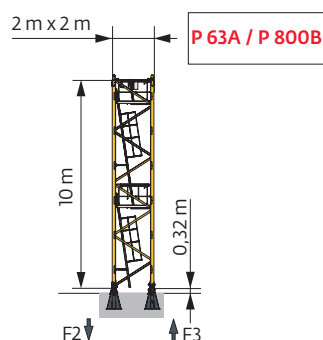

Ancrages / Verankerungen / Anchorages / Anclajes / Ancoraggi
Ancoragem / нкера

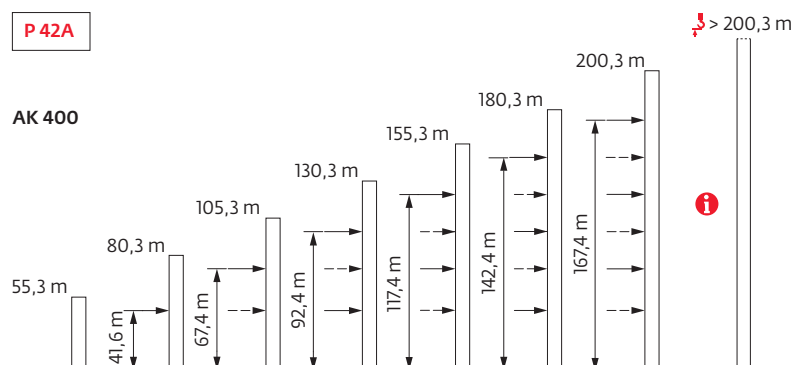

Lest de base / Grundballast / Base ballast / Lastre de base / Zavorra di base
 Lastro da base / Базовый Балласт

⚖️ (t) / 📏 1,6 m City - ZC 4230 - 🚛

📏 (m)	25	30	35	40	45	50	55	60
41	90	85	80	80	80	75	80	75
36	90	85	85	85	85	80	70	70
31	80	80	80	75	75	75	70	70
26	80	80	75	75	75	70	70	70
21	80	80	75	75	75	70	70	70

⚖️ (t) / 📏 1,6 m City - ZD 4230 - 🚛

📏 (m)	25	30	35	40	45	50	55	60
51	80	80	80	80	80	80	80	80
49,4	80	80	80	80	80	75	70	75
44,4	80	75	75	75	75	70	60	60
39,4	70	70	65	65	65	65	55	50
34,4	65	65	65	65	60	55	45	45
29,4	65	65	65	65	60	55	45	45
24,4	65	65	65	65	60	55	45	45
19,4	65	65	65	65	60	55	45	45

⚖️ (t) / 📏 1,6 m - S 41A - 🚛

📏 (m)	25	30	35	40	45	50	55	60
56,8	114				114			
55,1	102	108	108	108	102	108	108	114
50,1	84	84	84	84	78	84	78	84
45,1	78	78	78	78	78	72	60	60
40,1	72	72	66	66	66	66	54	54
35,1	66	66	60	60	60	54	48	48
30,1	60	60	60	60	54	48	42	42
25,1	60	60	60	60	54	48	42	42
20,1	60	60	60	60	54	48	42	42

⚖️ (t) / 📏 1,6 m - ZD 463 - 🚛

📏 (m)	25	30	35	40	45	50	55	60
58	120							
56,4	115	115	115	115	115			
54,7	105	110	110	105	105	110	110	115
49,7	80	80	80	80	75	80	80	85
44,7	75	75	70	70	70	70	60	60
39,7	65	65	65	65	65	60	50	50
34,7	60	60	60	55	55	50	45	40
29,7	60	60	55	55	50	45	35	35
24,7	60	60	55	55	50	45	35	35
19,7	60	60	55	55	50	45	35	35

⚖️ (t) / 📏 2 m - V 60A - 🚛

📏 (m)	25	30	35	40	45	50	55	60
66,2	132	132	132	132	132	132	132	132
61,2	108	108	108	108	108	108	108	108
56,2	84	84	84	84	72	84	84	84
51,2	60	60	60	60	60	60	60	60
46,2	36	36	36	36	36	36	36	36
41,2	36	36	24	24	24	24	24	24
36,2	24	24	24	24	24	24	24	24
31,2	24	24	24	24	24	24	24	24
26,2	24	24	24	24	24	24	24	24
21,2	24	24	24	24	24	24	24	24

⚖️ (t) / 📏 2 m - ZX 640 - 🚛

📏 (m)	25	30	35	40	45	50	55	60
79,6	220	220	220	220	220			
77,9	200	210	210	210	210	210	210	210
72,9	170	170	170	170	170	170	170	180
67,9	140	140	140	140	140	140	140	150
62,9	110	120	110	110	110	120	110	120
57,9	90	90	90	90	90	90	90	90
52,9	60	70	60	60	60	70	60	70
47,9	40	40	40	40	40	40	40	50
42,9	30	30	30	30	30	20	20	30
37,9 ↓	30	30	30	30	20	20	20	20
17,9	30	30	30	30	20	20	20	20

⚖️ (t) / 📏 2 m - ZD 463 - 🚛

📏 (m)	25	30	35	40	45	50	55	60
53	115	120	120	115	115	120	120	125
48	85	85	85	85	80	85	85	90
43	60	60	60	55	55	55	55	60
38	55	55	55	55	50	45	35	35
33	55	55	55	55	50	45	35	35
28	55	55	55	55	50	45	35	35
23	55	55	55	55	50	45	35	35

Courbes de charges / Lastkurven / Load curves / Curvas de cargas / Curve di carico
 Curvas de carga / Кривые нагрузок



▼▲▲▲▲ (m)		17	20	22	25	27	30	32	35	37	40	42	45	47	50	52	55	57	60	m		
▼▲▲▲	▼▲▲▲ 8 t	▼▲▲▲ 4 t	▼▲▲▲							▼▲▲▲												
60	2,7 → 19,2	32,3 - 34,4	8	7,6	6,8	5,8	5,2	4,5	4	3,9	3,6	3,3	3,1	2,8	2,6	2,35	2,2	2	1,85	1,7	t	
	2,7 → 19,7	32,4 - 35	8	7,8	6,9	5,8	5,2	4,5	4,1	4	3,7	3,4	3,2	2,9	2,75	2,5	2,3	2,1	1,95	1,8	t P+	
55	2,7 → 20,6	34,4 - 37	8	8	7,4	6,3	5,7	4,9	4,4	4	4	3,6	3,4	3	2,85	2,6	2,45	2,2	t			
	2,7 → 20,8	34,6 - 37,3	8	8	7,5	6,3	5,7	4,9	4,5	4	4	3,7	3,4	3,2	3	2,75	2,55	2,35	t P+			
50	2,7 → 20,3	36,6 - 39,2	8	8	7,3	6,3	5,8	5,1	4,7	4,2	4	3,9	3,6	3,3	3,1	2,9	t					
	2,7 → 22	36,7 - 40	8	8	7,8	6,8	6,2	5,3	4,8	4,3	4	4	3,7	3,4	3,2	3	t P+					
45	2,7 → 21,5	39 - 42	8	8	7,8	6,8	6,2	5,5	5,1	4,6	4,3	4	4	3,7	t							
	2,7 → 23,4	39,3 - 42,3	8	8	8	7,4	6,7	5,8	5,3	4,7	4,3	4	4	3,7	t P+							
40	2,7 → 21,6	39,3 - 40	8	8	7,8	6,8	6,2	5,5	5,1	4,6	4,3	4	t									
	2,7 → 23,4		8	8	8	7,4	6,8	6	5,6	5	4,7	4,3	t P+									
35	2,7 → 21,6		8	8	7,8	6,8	6,2	5,5	5,1	4,6	t											
	2,7 → 23,3		8	8	8	7,4	6,8	6	5,6	5	t P+											
30	2,7 → 21,7		8	8	7,8	6,8	6,3	5,6	t													
	2,7 → 23,3		8	8	8	7,4	6,8	6	t P+													
25	2,7 → 22,8		8	8	8	7,2	t															
	2,7 → 24,1		8	8	8	7,7	t P+															

▼▲▲▲ = ▼▲▲ - 0,49 t max.



▼▲▲▲▲ (m)		17	20	22	25	27	30	32	35	37	40	42	45	47	50	52	55	57	60	m		
▼▲▲▲	▼▲▲▲ 8 t	▼▲▲▲ 4 t	▼▲▲▲							▼▲▲▲												
60	2,1 → 19,6	33,2 - 33,4	8	7,8	7	5,9	5,3	4,6	4,2	3,8	3,5	3,1	2,9	2,65	2,45	2,2	2,05	1,85	1,7	1,55	t	
	2,1 → 20,1	33,4 - 33,6	8	8	7,1	6	5,3	4,6	4,2	3,8	3,6	3,2	3	2,75	2,6	2,35	2,15	1,95	1,8	1,65	t P+	
55	2,1 → 21	35,4 - 35,4	8	8	7,6	6,5	5,8	5,1	4,6	4,1	3,8	3,4	3,2	2,9	2,7	2,45	2,3	2,05	t			
	2,1 → 21,2	35,6 - 36,1	8	8	7,6	6,5	5,8	5,1	4,6	4,1	3,9	3,5	3,3	3	2,85	2,6	2,4	2,2	t P+			
50	2,1 → 20,6	37,6 - 38	8	8	7,5	6,5	6	5,3	4,9	4,4	4,1	3,8	3,5	3,2	3	2,75	t					
	2,1 → 22,4	37,8 - 38,4	8	8	8	7	6,3	5,5	5	4,4	4,1	3,8	3,6	3,3	3,1	2,85	t P+					
45	2,1 → 22	40,2 - 41	8	8	8	6,9	6,4	5,6	5,3	4,7	4,4	4	3,8	3,5	t							
	2,1 → 23,8	40,5 - 41	8	8	8	7,5	6,9	6	5,5	4,8	4,5	4,1	3,9	3,6	t P+							
40	2,1 → 22		8	8	8	7	6,4	5,7	5,3	4,8	4,5	4,1	t									
	2,1 → 23,8		8	8	8	7,6	7	6,2	5,8	5,2	4,9	4,5	t P+									
35	2,1 → 22		8	8	8	7	6,4	5,7	5,3	4,8	t											
	2,1 → 23,7		8	8	8	7,5	6,9	6,2	5,7	5,2	t P+											
30	2,1 → 22,1		8	8	8	7	6,4	5,7	t													
	2,1 → 23,7		8	8	8	7,5	6,9	6,2	t P+													
25	2,1 → 23,2		8	8	8	7,4	t															
	2,1 → 24,5		8	8	8	7,8	t P+															

▼▲▲▲ = ▼▲▲ - 0,18 t max.

Poids de flèche & lest de contre-flèche / Auslegergewicht & Gegenauslegerballast / Jib weight & counter-jib ballast / Peso de flecha y lastre de contra-flecha / Peso del braccio & zavorra di contro-braccio / Peso da lança & lastro da contra lança
 Вес стрелы и балласт контр-стрелы

▼▲▲▲	▼▲▲▲▲ (kg) - 33 LVF (+/- 5%)			▼▲▲▲		▼▲▲▲ (kg)
	▼▲▲▲ 4 t	▼▲▲▲	▼▲▲▲ 8 t	3600 kg	1100 kg	
60 m	8930	8750	9090	3	4	15200
55 m	8735	8555	8895	3	4	15200
50 m	8505	8325	8665	3	3	14100
45 m	8210	8030	8370	3	3	14100
40 m	7870	7690	8030	3	2	13000
35 m	7500	7320	7660	3	1	11900
30 m	7135	6960	7300	3	0	10800
25 m	6765	6585	6925	2	3	10500



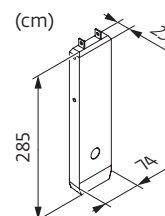
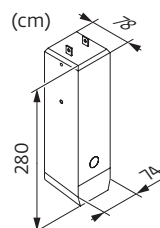

CAU - 3600 kg

CAV - 1100 kg











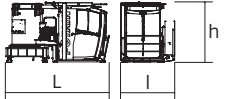

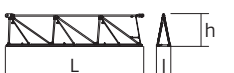
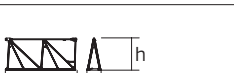











Encombremet et poids / Abmessungen und Gewicht / Dimensions and weight / Dimensiones y peso / Ingombro e peso
dimensões e pesos / габаритные размеры и вес

Partie tournante / Drehender Kranteil / Slewing crane part / Parte giratoria

Parte rotante / Parte rotativa / Поворотная часть :  60 m -  -  -  33 LVF

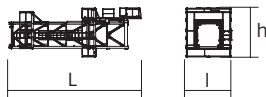
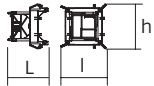
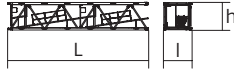
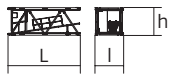

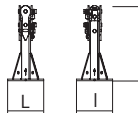
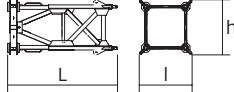
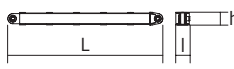
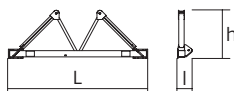
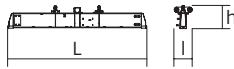
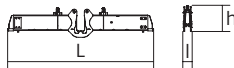
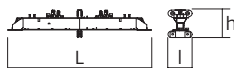
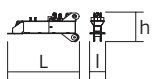
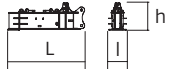
Partie tournante / Drehender Kranteil / Slewing crane part Parte giratoria / Parte rotante / Parte rotativa Поворотная часть	L (m)	l (m)	h (m)	kg (+/- 5%)		
Contre-flèche / Gegenausleger Counter-jib / Contra-flecha Controbraccio / Contra-lança Контр-стрела		11,86	1,33	2,5	5000	
Pivot + cabine / Krankopf + Kabine Towerhead + cab / Pivote + cabina Portaralla + cabina / Pivot + cabina Секция поворотной части + кабина		4,32	2,25	2,47	6050	
Elément de flèche / Auslegerement Jib section / Elemento de flecha Elemento di braccio / Elemento de lança Секция стрелы		① 33 LVF 6 DVF	10,98	2,93	2,61	3810
Elément de flèche / Auslegerement Jib section / Elemento de flecha Elemento di braccio / Elemento de lança Секция стрелы		②	10,24	1,05	2,37	1460
Elément de flèche / Auslegerement Jib section / Elemento de flecha Elemento di braccio / Elemento de lança Секция стрелы		③ ④ ⑥ ⑦ ⑨	5,2 5,19 5,18 5,17 5,16	1,05 1,05 1,05 1,05 1,05	2,35 2,33 1,92 1,89 1,19	605 580 400 345 230
Elément de flèche / Auslegerement Jib section / Elemento de flecha Elemento di braccio / Elemento de lança Секция стрелы		⑤ ⑧	5,19 5,16	1,05 1,05	2,33 1,9	450 295
Elément de flèche / Auslegerement Jib section / Elemento de flecha Elemento di braccio / Elemento de lança Секция стрелы		⑩	5,09	1,05	1,17	190
Treuil de levage (+ câble) / Hubwerk (+ Seil) Hoisting winch (+ rope) / Mecanismo de elevación (+ cabo) Argano di sollevamento (+ fune) Guincho de elevação (+ cabo) Подъёмная лебёдка (+ канатом)		33 LVF 50 LVF 50 LVF GH	1,36 1,53 1,61	0,82 0,96 1,35	0,75 0,92 1,26	910 1200 1945
Chariot / Laufkatze Trolley / Carrello Carro / Carro-distribuidor Тележка		 8 t	1,58	1,33	0,87	280
Moufle / Hubflasche Pulley block / Aparejo Bozzello / Cadernal Полиспаст		 8 t	0,9	0,23	1,41	280
Chariot / Laufkatze Trolley / Carrello Carro / Carro-distribuidor Тележка		 8 t	1,39	1,26	0,95	280
Chariot / Laufkatze Trolley / Carrello Carro / Carro-distribuidor Тележка		 8 t  4 t	1,42 1,51	1,26 1,3	0,95 0,95	280 235
Moufle / Hubflasche Pulley block / Aparejo Bozzello / Cadernal Полиспаст		 8 t  4 t	1,26 0,79	0,27 0,17	1,53 1,36	250 130

Pyłone / Kranturm / Crane tower Mástil / Torre / Torre Башня крана		L (m)	I (m)	h (m)	kg (+/- 5%)
T 41 T 61		10,85 10,83	3,73 4,14	4,1 4,47	7100 9700
K40/K40-2 K60/K40-2		2,21 2,21	2,1 2,51	2,06 2,47	1330 2640
K 447E KM 447E KM 449E K 649B KM 649E KRM 6410B		10,21 10,21 10,21 10,23 10,29 10,23	1,62 1,62 1,62 2,07 2,03 2,1	1,62 1,62 1,62 2,03 2,03 2,08	3390 3215 4005 5290 4850 7100
K 447A KMT 447A K 449A KMT 449A KR 649A KRM 649A K 649A KMT 649A		5,21 5,21 5,21 5,21 5,23 5,23 5,23 5,23	1,67 1,67 1,67 1,67 2,1 2,1 2,07 2,07	1,62 1,62 1,62 1,62 2,08 2,08 2,03 2,03	1850 1745 2230 2130 3250 3050 2805 2570
K 447C KMT 447C K 649C KMT 649C KRM 649C		3,45 3,54 3,57 3,57 3,57	1,67 1,67 2,07 2,07 2,1	1,62 1,62 2,03 2,03 2,08	1360 1350 2070 2060 2450
Pieds de scellement / VerankerungsfüÙe Fixing angles / Pie de empotramiento Montante da anngare / Angulos fixadores анкера		0,56 0,75	0,56 0,75	1,17 1,28	240 465
Mât-châssis / Grundmasteinheit Basic mast unit / Tramo-chassis Elemento base / Tramo-chassis Мачта для крепления к шасси		3,63 5,01	1,96 2,41	2,08 2,41	3235 4760
Haubans / Mastabstützungen Struts / Tornapuntas Puntoni / Escoras Растяжка		3,18 4,51	0,26 0,29	0,24 0,29	370 470
Sommier / Unterwagenhälfte Half-bearer / Testero Testata / Estrutura base Траверса		5,1 6,7	0,6 0,7	1,78 2,31	1050 1840
Bras de croix / Fundamentkreuzträger Cross girder / Braço en cruz Braccio croce / Braço da cruz Поперечная балка		5,64 6,63	0,82 0,82	1,05 1,05	1590 1830
Bras de croix / Fundamentkreuzträger Cross girder / Braço en cruz Braccio croce / Braço da cruz Поперечная балка		5,64 6,63	0,47 0,47	1,34 1,34	1895 2135
Bras de croix / Fundamentkreuzträger Cross girder / Braço en cruz Braccio croce / Braço da cruz Поперечная балка		7,65	1,17	1,36	3585
1/2 Bras de croix / 1/2 Fundamentkreuzträger 1/2 Cross girder / 1/2 Braço en cruz 1/2 Braccio croce / 1/2 Braço da cruz 1/2 Поперечная балка		3,41	0,7	1,35	1655
1/2 Bras de croix / 1/2 Fundamentkreuzträger 1/2 Cross girder / 1/2 Braço en cruz 1/2 Braccio croce / 1/2 Braço da cruz 1/2 Поперечная балка		4,35	1	1,56	3320
Bras de croix / Fundamentkreuzträger Cross girder / Braço en cruz / Braccio croce / Braço da cruz Поперечная балка		9,15	1,19	1,56	6880

Mécanismes / Triebwerke / Mechanisms / Mecanismos / Meccanismi
 Mecanismos / Механизмы

400 V - 50 Hz 480 V - 60 Hz										ch - PS hp	kW		
	33 LVF 20 Optima	m/min	27	36	51	73	14	18	27	37	33	22	290 m
		t	4	3	2	0,8	8	6	4	1,8			
	50 LVF 20 Optima	m/min	48	62	87	121	25	33	46	61	50	37	363 m
		t	4	3	2	1,1	8	6	4	2,5			
	50 LVF 20 GH Optima	m/min	49	64	88	113	25	32	46	57	50	37	634 m
		t	4	3	2	1,1	8	6	4	2,6			
	6 DVF 4 Optima	m/min	0 → 80 (8 t) 0 → 100 (2 t)						5,5	4			
	RVF 152 Optima+	tr/min U/min rpm	0 → 0,8						2 x 5,5	2 x 4			

	IEC 60204-32		kVA	
400 V (+10% -10%) 50 Hz 480 V (+6% -10%) 60 Hz		33 LVF : 41 → 28 kVA 50 LVF / 50 LVF GH : 54 → 34 kVA		

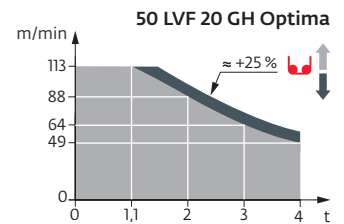
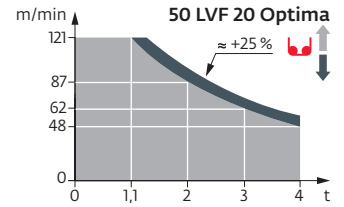
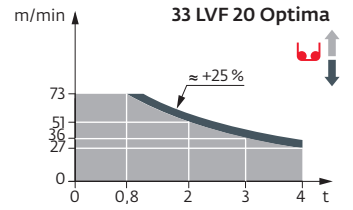

	FR	DE	EN	ES	IT	PT	RU
	Appel de flèche	Auslegerüberhöhung	Jib elevation	Elevación de la flecha	Inclinazione braccio	Desvio da lança	подъем стрелы
	Équipements standards	Standardausrüstungen	Standard equipment	Equipamiento de serie	Equipaggiamento standard	Equipamento de série	Стандартное оборудование
	Équipements optionnels	Sonderausrüstungen	Options	Equipamiento opcional	Equipaggiamento in opzione	Equipamento opcional	Дополнительное оборудование (опция)
	Fonction Potain Plus : Courbes de charges Plus	Funktion Potain Plus: Plus-Lastkurven	Potain Plus function: Plus load curves	Función Potain Plus: Diagrama de cargas Plus	Funzione Potain Plus: Curve di carico Plus	Função Potain Plus: Diagrama de cargas Plus	Функция контроля мощности Potain Plus: Диаграммы грузоподъемности Plus
	Hauteurs sous crochet associées aux courbes de charges Plus	Hakenhöhen mit Plus-Lastkurven	Hook heights with Plus load curves	Altura bajo gancho, usando el diagrama de cargas Plus	Altezze sotto gancio con curve di carico Plus	Altura livre, utilizando o diagrama de cargas Plus	Высота под крюком для диаграмм грузоподъемности Plus
	Réactions en service	Reaktionskräfte in Betrieb	Reactions in service	Reacciones en servicio	Reazioni in servizio	Reacções em serviço	Реакция при работе
	Réactions hors service	Reaktionskräfte außer Betrieb	Reactions out of service	Reacciones fuera de servicio	Reazioni fuori servizio	Reacções fora de serviço	Реакция в покое
	Poids total du lest	Ballast-Gesamtwicht	Total ballast weight	Peso total del lastre	Peso totale della zavorra	Peso total do lastro	Общий вес балласта
	Cadre d'ancrage serré	Fester Verankerungsrahmen	Tightened anchorage frame	Marco de anclaje de apriete	Quadro di ancoraggio stretto	Quadro de amarração apertado	Прикрепленная анкерная рама
	Cadre d'ancrage desserré	Loser Verankerungsrahmen	Loosened anchorage frame	Marco de anclaje de desapriete	Quadro di ancoraggio allentato	Quadro de amarração solto	Отсоединенная анкерная рама
	Poids de flèche	Auslegergewicht	Jib weight	Peso de flecha	Peso del braccio	Peso da lança	вес стрелы
	Camion 13,4 m	Lkw 13,4 m	Lorry 13,4 m	Camión 13,4 m	Camion 13,4 m	Camião 13,4 m	Рзусовой автомобиль 13,4 м
	Conteneur High Cube 40', et/ou Flat Rack 20'	Container High Cube 40', und/oder Flat Rack 20'	Container High Cube 40', and/or Flat Rack 20'	Contenedor High Cube 40', y/o Flat Rack 20'	Container High Cube 40', e/o Flat Rack 20'	Contentor High Cube 40', e/ou Flat Rack 20'	40-фусовой контейнер повышенной вместимости High Cube, и/или 20-фусовая открытая платформа Flat Rack
	Levage	Heben	Hoisting	Elevación	Sollevamento	Elevação	Подъем
	Distribution	Katzfahren	Trolleying	Distribución	Distribuzione	Distribuição	Перемещение по стреле
	Orientation	Schwenken	Slewing	Orientación	Rotazione	Rotação	Поворот
	Translation	Kranfahren	Travelling	Traslación	Traslazione	Translação	Перемещение крана
	Puissance requise	Erforderliche Leistung	Required power	Potencia Necesaria	Potenza richiesta	Potência Necessária	Потребляемая мощность
	Fonction Power Control : vitesses treuils adaptées à la puissance disponible	Funktion Power Control: Geschwindigkeiten der Triebwerke werden an die verfügbare Leistung angepasst	Power Control Function: winch speeds adapted to the available power	Función Power Control: marchas de los cabrestantes adaptadas a la potencia disponible	Funzione Power Control: velocità degli argani adattate alla potenza disponibile	Função Power Control: velocidades de guincho adaptadas à potência disponível	Функция контроля мощности Power Control: регулировка скорости лебедок в зависимости от доступной мощности
	Nous consulter	Auf Anfrage	Consult us	Consultarnos	Consultateci	Consultar-nos	Проконсультируйтесь у нас
	Document commercial non contractuel. Pour toute information technique se référer à la notice correspondante.	Unverbindliches Vertriebsdokument. Für technische Informationen, siehe die entsprechenden Anweisungen.	This commercial document is not legally binding. For any technical information, please refer to the corresponding instructions.	Documento comercial no contractual. Para cualquier información técnica, ver la noticia correspondiente.	Documento commerciale non vincolante, per tutte le informazioni tecniche fare riferimento al catalogo istruzioni.	Documento comercial não contractual. Para qualquer informação técnica complementar consultar as respectivas instruções.	Этот коммерческий документ не является юридически обязательным. Для получения технической информации, см. соответствующие инструкции.

