

MCT 85 F5

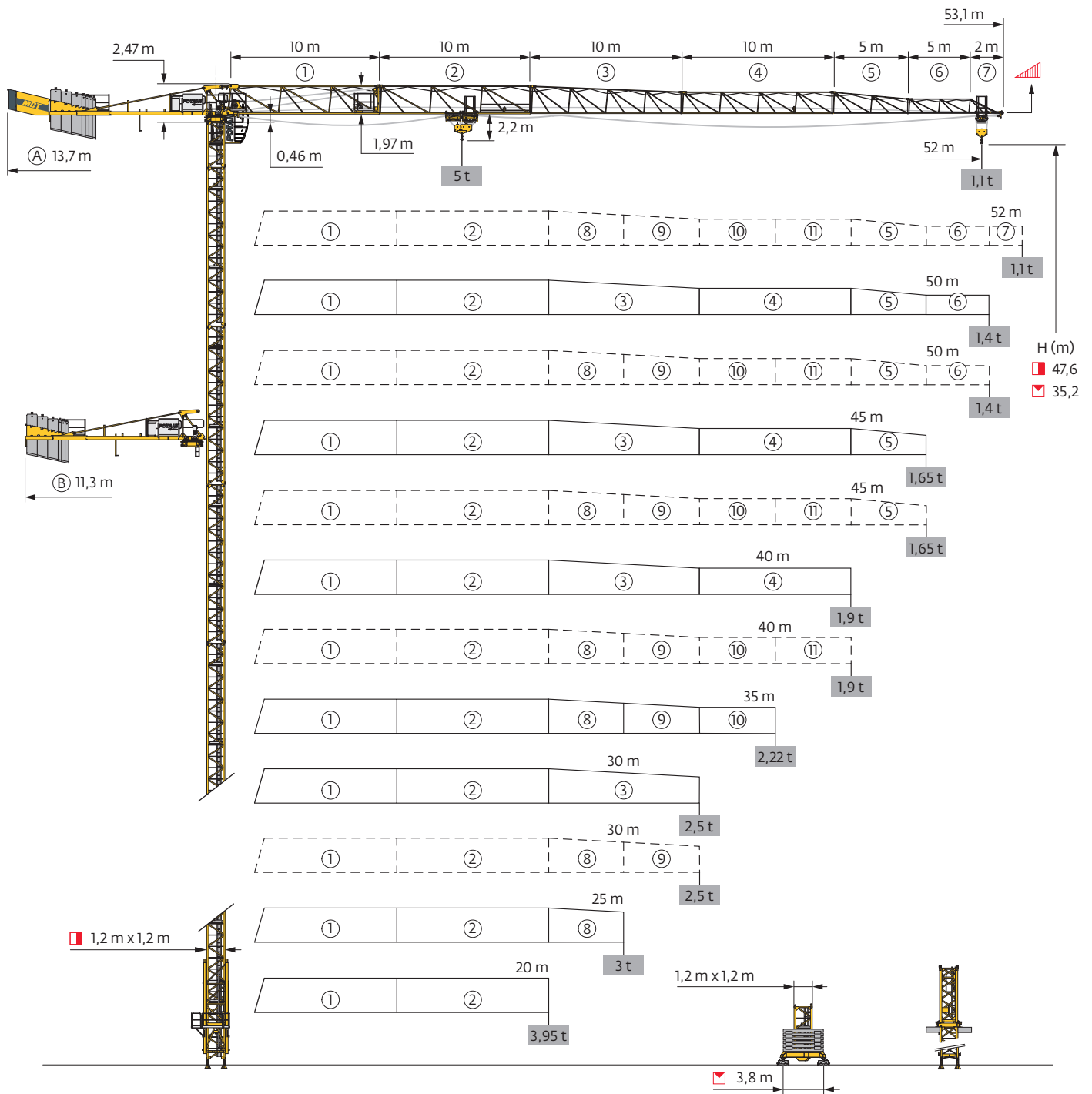

Mât - Réactions / Mast - Reaktionskräfte / Mast - Reactions / Mástil - Reacciones / Torre - Reazioni
 Tramo - Reações / Реакция опор мачты

1,2 m
 20 m → 52 m

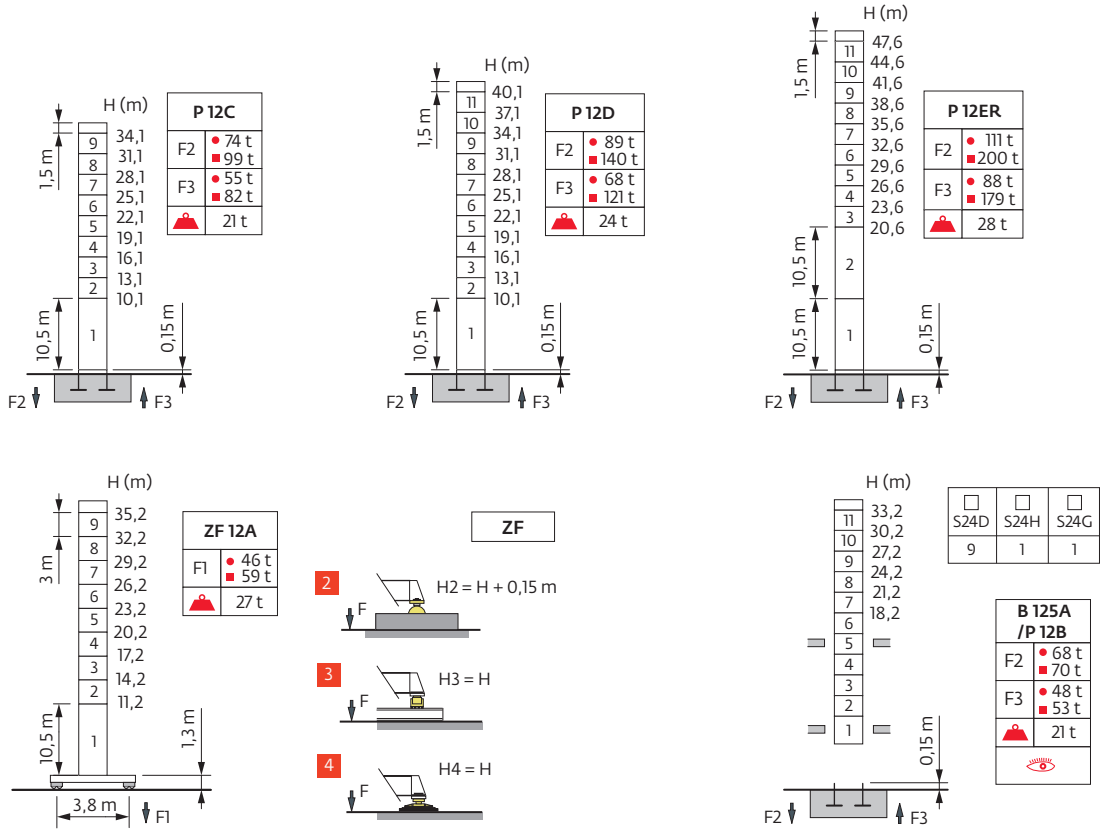

Télescopage sur dalle / Kletterkrane im Gebäude / Climbing crane / Telescopage gruas trepadoras / Gru in caviedio
 Telescopagem sobre lages / Кран, ползущий внутри здания

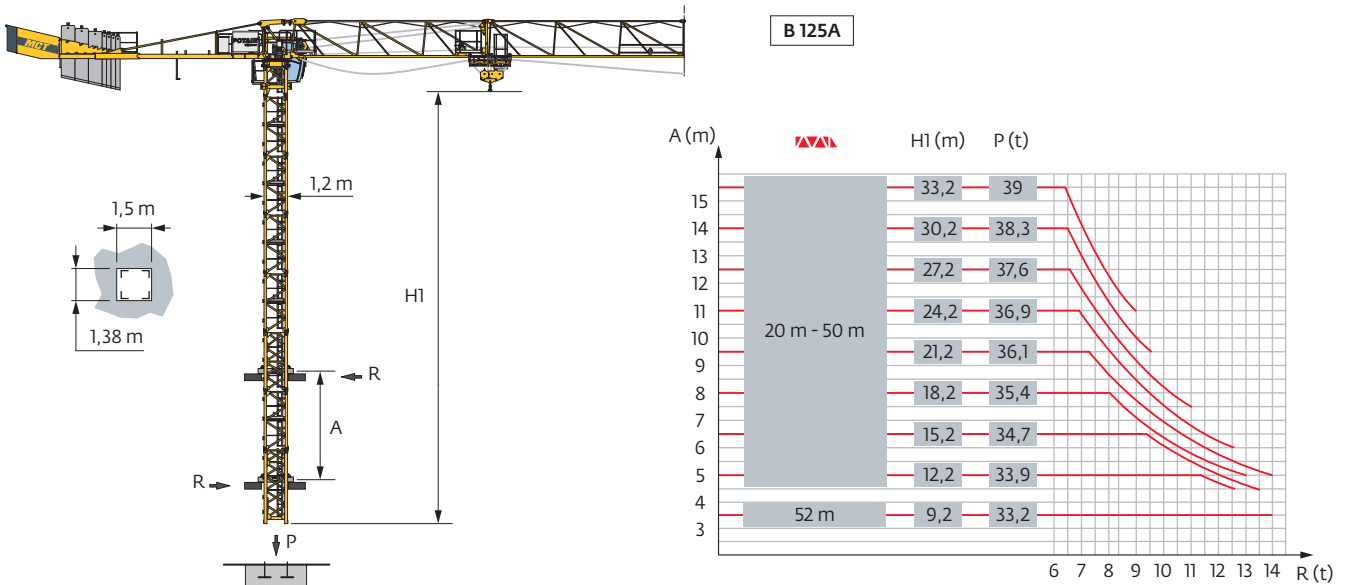

Anchages / Verankerungen / Anchorages / Anclajes / Ancoraggi
 Ancoragem / Анкера

P 12C

AL 201

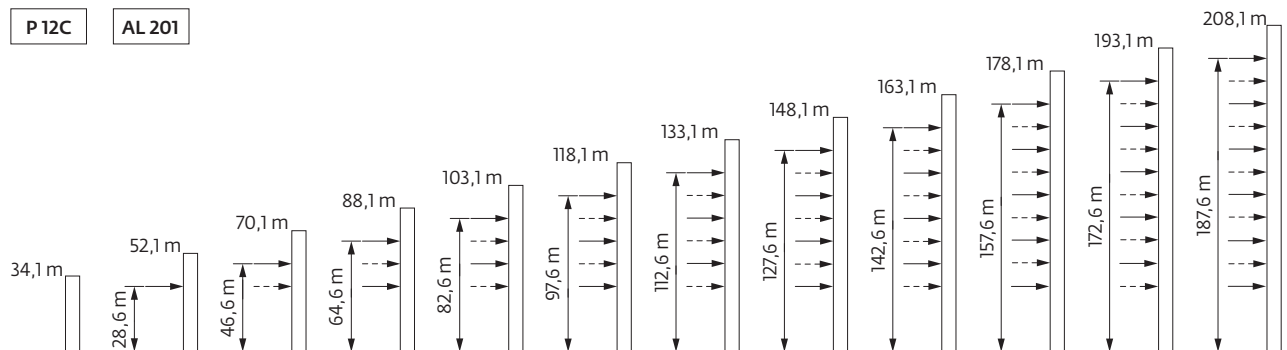

i H > 208,1 m

P 12D

AL 201

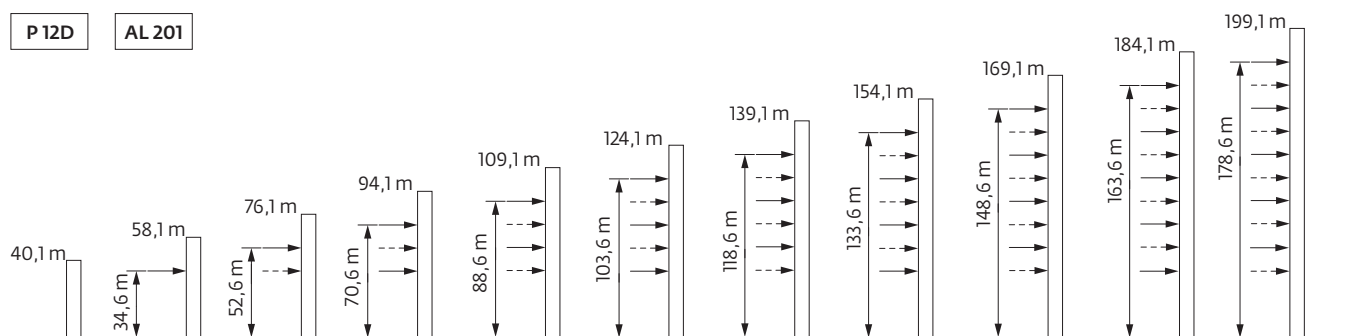

i H > 199,1 m



Courbes de charges / Lastkurven / Load curves / Curvas de cargas / Curve di carico
 Curvas de carga / Кривые нагрузок



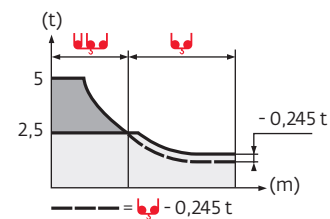

52 m	2,7	▶	13,7	15	17	20	22	24,3	26,4	27	30	32	35	37	40	42	45	47	50	52	m
▲▲▲			5	4,5	3,9	3,2	2,85	2,5	-2,5	2,45	2,15	2	1,8	1,7	1,55	1,45	1,3	1,25	1,15	1,1	t
50 m	2,7	▶		15,9	17	20	22	25	27	28,3	30,7	32	35	37	40	42	45	47	50		m
▲▲▲				5	4,6	3,8	3,4	2,9	2,65	2,5	-2,5	2,4	2,15	2	1,85	1,75	1,6	1,5	1,4		t
45 m	2,7	▶		16,3	17	20	22	25	27	29,1	31,6	32	35	37	40	42	45				m
▲▲▲				5	4,8	3,9	3,5	3	2,75	2,5	-2,5	2,45	2,2	2,1	1,9	1,8	1,65				t
40 m	2,7	▶		16,4	17	20	22	25	27	29,1	31,6	32	35	37	40						m
▲▲▲				5	4,8	3,9	3,5	3	2,75	2,5	-2,5	2,45	2,2	2,1	1,9						t
35 m	2,7	▶		16,4	17	20	22	25	27	29,1	31,6	32	35								m
▲▲▲				5	4,8	3,9	3,5	3,0	2,75	2,5	-2,5	2,45	2,22								t
30 m	2,7	▶		16,3	17	20	22	25	27	29	30										m
▲▲▲				5	4,8	3,9	3,5	3	2,75	2,5	-2,5										t
25 m	2,7	▶		16,3	17	20	22	25													m
▲▲▲				5	4,8	3,9	3,5	3,02													t
20 m	2,7	▶		16,3	17	20															m
▲▲▲				5	4,8	3,95															t



Lest de base / Grundballast / Base ballast / Lastre de base / Zavorra di base
 Lastro da base / Базовый Балласт

 1,2 m	ZF 12 A	H (m)	35,2	33,7	32,2	30,7	29,2	27,7	26,2	24,7	23,2	21,7	20,2	18,7	17,2	15,7	14,2	12,7	11,2
		 (t)	65	50	45	35	30	30	30	30	30	30	30	30	30	30	30	30	30

Poids de flèche & lest de contre-flèche / Auslegergewicht & Gegenauslegerballast / Jib weight & counter-jib ballast / Peso de flecha y lastre de contra-flecha / Peso del braccio & zavorra di contro-braccio / Peso da lança & lastro da contra lança
 Вес стрелы и балласт контр-стрелы

40 LVF / 25 PC 			
	3000 kg	1000 kg	 (kg)
52 m	3	4	13 000
50 m	3	4	13 000
45 m	3	3	12 000
40 m	3	2	11 000
45 m	3	1	10 000
30 m	3	0	9 000
25 m	2	2	8 000
20 m	2	1	7 000

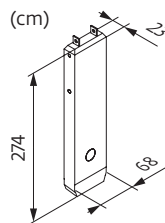
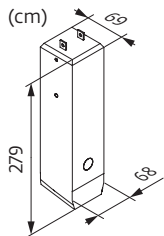

CBP - 3 000 kg

CBQ - 1 000 kg











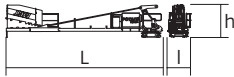
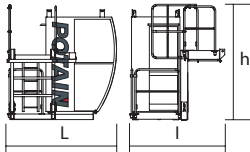
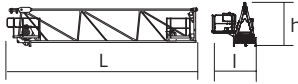
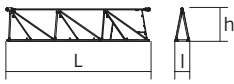
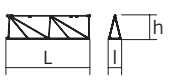
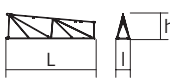
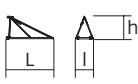
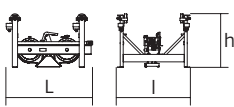
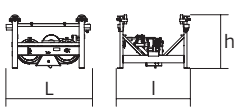
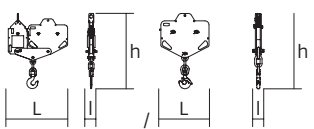
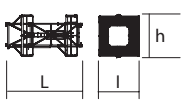

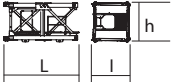

Encombremet et poids / Abmessungen und Gewicht / Dimensions and weight / Dimensiones y peso / Ingombro e peso
dimensões e pesos / габаритные размеры и вес

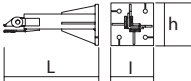
Partie tournante / Drehender Kranteil / Slewing crane part / Parte giratoria

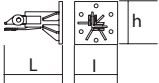

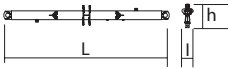

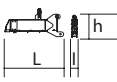



Parte rotante / Parte rotativa / Поворотная часть :  52 m -  25 PC / 40 LVF











Partie tournante / Drehender Kranteil / Slewing crane part Parte giratoria / Parte rotante / Parte rotativa Поворотная часть		L (m)	l (m)	h (m)	kg (+/- 5%)
Contre-flèche / Gegenausleger Counter-jib / Contra-flecha Controbraccio / Contra-lança Контр-стрела		14,6 11,9	1,61 1,76	2,47 2,47	4380 4250
Cabine / Kabine Cab / Cabina Cabina / Cabina Кабина		2,06	2,15	2,62	390
Elément de flèche / Auslegerelement Jib section / Elemento de flecha Elemento di braccio / Elemento de lança Секция стрелы		10,62 10,62	1,82 1,82	2,2 2,2	3244 2984
Elément de flèche / Auslegerelement Jib section / Elemento de flecha Elemento di braccio / Elemento de lança Секция стрелы		10,21 10,17 10,14	0,8 0,8 0,8	1,95 1,91 1,48	1140 742 566
Elément de flèche / Auslegerelement Jib section / Elemento de flecha Elemento di braccio / Elemento de lança Секция стрелы		5,15 5,14 5,13 5,08	0,8 0,8 0,8 0,8	1,9 1,5 1,48 1	325 290 285 175
Elément de flèche / Auslegerelement Jib section / Elemento de flecha Elemento di braccio / Elemento de lança Секция стрелы		5,17 5,11	0,8 0,8	1,91 1,47	400 195
Elément de flèche / Auslegerelement Jib section / Elemento de flecha Elemento di braccio / Elemento de lança Секция стрелы		2,05	0,8	1	60
Chariot / Laufkatze Trolley / Carrello Carro / Carro-distribuidor Тележка		1,1	1	0,72	130
Chariot / Laufkatze Trolley / Carrello Carro / Carro-distribuidor Тележка		1,13 1,14	1 1	0,72 0,72	115 165
Moufle / Hubflasche Pulley block / Aparejo Bozzello / Cadernal Полиспаст		1,09 0,74	0,21 0,2	1,38 1,13	235 135
Equipement de télescopage / Teleskopierausrüstung / Telescoping equipment Equipo de telescopaje / Equipaggiamento di telescopaggio / Equipamento de telescopagem Оборудование для телескопирования					
Cage de télescopage / Teleskopwagen Telescopic cage / Jaula de telescopaje Gabbia di telescopaggio / Gaiola de telescopagem для телескопирования крана		6,3	3,61	3,63	1980









Mâtire / Mastwerk / Masts Mástil / Torre / Coluna Мачты							
S 24D1 S 24D2 SR 24D1			1,2 m 1,2 m 1,2 m	3,2 3,2 3,2	1,29 1,29 1,29	1,26 1,26 1,26	750 780 720
SR 24 BS S 26 BS SR 28 ER			1,2 m 1,2 m 1,2 m	10,7 10,7 10,7	1,3 1,3 1,3	1,28 1,27 1,3	2250 3070 4060
Bases / Kranbasen / Crane bases Bases / Basi / Bases фундамент под кран							
Pieds de scellement / VerankerungsfüÙe Fixing angles / Pie de empotramiento Montante da anegare / Angulos fixadores анкера			P 12C P 12D P 12ER	1,1 1,1 1,3	0,5 0,5 0,8	0,5 0,5 0,8	106 162 500
			R 12C R 12D R 12ER	0,68 0,73 0,8	0,5 0,5 0,6	0,5 0,5 0,6	145 147 500
Bras de croix / Fundamentkruzträger Cross girder / Brazo en cruz Braccio croce / Braço da cruz Поперечная балка			ZF 12A	5,64	0,67	1,4	1540
1/2 Bras de croix / 1/2 Fundamentkruzträger 1/2 Cross girder / 1/2 Brazo en cruz 1/2 Braccio croce / 1/2 Braço da cruz 1/2 Поперечная балка			ZF 12A	2,98 2,98	0,4 0,43	1,41 1,41	895 925









Mécanismes / Triebwerke / Mechanisms / Mecanismos / Meccanismi
Mecanismos / Механизмы

400 V - 50 Hz											ch - PS hp	kW		
	25 PC 13	m/min	9	35,5	71			4,4	17,7	35,4	25	18,5	360 m	
		t	2,5	2,5	1,3			5	5	2,6				
	4 D3 V3	m/min	15 → 30 → 58									4	3	
	RCV 60	tr/min U/min rpm	0 → 0,8									8	5,8	
														

400 V - 50 Hz													hp	kW	
	40 LVF 13 GH	m/min	5	13	41	61	81,5	2,45	6,5	20,4	30,6	40,8	40	30	425 m
		t	2,5	2,5	2,5	1,9	1,25	5	5	5	3,75	2,5			
	4 DVF 3	m/min	0 → 63									5	3,7		
	RVF 151 Optima+	tr/min U/min rpm	0 → 0,8									5,5	4		
															

 IEC 60204-32	
400 V (+10% -10%) 50 Hz	40 LVF : 40 kVA 25 PC : 30 kVA

480 V - 60 Hz											ch - PS hp	kW		
	25 PC 13	m/min	10,5	42,5	85			5,3	21,2	42,5	30	22,1	360 m	
		t	2,5	2,5	1,3			5	5	2,6				
	4 D3 V3	m/min	18 → 36 → 70									4,8	3,6	
	RCV 60	tr/min U/min rpm	0 → 0,96									9,6	7	
														

480 V - 60 Hz													hp	kW	
	40 LVF 13 GH	m/min	5	13	41	61	81,5	2,45	6,5	20,4	30,6	40,8	40	30	425 m
		t	2,5	2,5	2,5	1,9	1,25	5	5	5	3,75	2,5			
	4 DVF 3	m/min	0 → 63									5	3,7		
	RVF 151 Optima+	tr/min U/min rpm	0 → 0,8									5,5	4		
															

 IEC 60204-32	
480 V (+6% -10%) 60 Hz	40 LVF : 40 kVA 25 PC : 36 kVA

40 LVF 13 GH

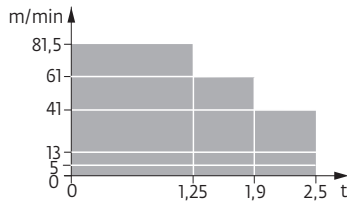

	FR	DE	EN	ES	IT	PT	RU
	Appel de flèche	Auslegerüberhöhung	Jib elevation	Elevación de la flecha	Inclinazione braccio	Desvio da lança	подъем стрелы
	Équipements standards	Standardausrüstungen	Standard equipment	Equipamiento de serie	Equipaggiamento standard	Equipamento de série	Стандартное оборудование
	Équipements optionnels	Sonderausrüstungen	Options	Equipamiento opcional	Equipaggiamento in opzione	Equipamento opcional	Дополнительное оборудование (опция)
	Réactions en service	Reaktionskräfte in Betrieb	Reactions in service	Reacciones en servicio	Reazioni in servizio	Reacções em serviço	Реакция при работе
	Réactions hors service	Reaktionskräfte außer Betrieb	Reactions out of service	Reacciones fuera de servicio	Reazioni fuori servizio	Reacções fora de serviço	Реакция в покое
	Hauteur sans cabine	Höhe ohne Kabine	Height without cab	Altura sin cabina	Altezza senza cabina	Altura sem cabina	Высота без кабины
	Poids à vide sans lest avec flèche et hauteur maximum	Gewicht ohne Last, ohne Ballast, mit Ausleger und max. Höhe	Weight without load, without ballast, with jib and max. height	Peso en vacío sin lastre, con flecha y altura máxima	Peso a vuoto, senza zavorra, con braccio e altezza massimi.	Peso em vazio sem lastro com lança e altura máxima.	Вес пустого, без балласта, со стрелой, максимальной высоты.
	Poids total du lest	Ballast-Gesamtgewicht	Total ballast weight	Peso total del lastre	Peso totale della zavorra	Peso total do lastro	Общий вес балласта
	Distance entre cadres	Abstand zwischen den Rahmen	Distance between collars	Distancia entra marcos	Distanza fra i telai	Distância entre quadros	Расстояние между рамками крепления
	Poids de la grue (en service)	Krangewicht (in Betrieb)	Crane weight (in service)	Peso de la grúa (en servicio)	Peso della gru (in servizio)	Peso da grua (em serviço)	Вес крана (при работе)
	Réaction horizontale	Horizontalkräfte	Horizontal reaction	Reaccion horizontal	Reazione orizzontale	Reacção horizontal	Горизонтальные реакции
	Camion 13,4 m	Lkw 13,4 m	Lorry 13,4 m	Camión 13,4 m	Camion 13,4 m	Camião 13,4 m	Ррузовой автомобиль 13,4 м
	Conteneur High Cube 40', et/ou Flat Rack 20'	Container High Cube 40', und/oder Flat Rack 20'	Container High Cube 40', and/or Flat Rack 20'	Contenedor High Cube 40', y/o Flat Rack 20'	Container High Cube 40', e/o Flat Rack 20'	Contentor High Cube 40', e/ou Flat Rack 20'	40-футовый контейнер повышенной вместимости High Cube, и/или 20-футовая открытая платформа Flat Rack
	Cadre d'ancrage serré	Fester Verankerungsrahmen	Tightened anchorage frame	Marco de anclaje de apriete	Quadro di ancoraggio stretto	Quadro de amarração apertado	Прикрепленная анкерная рама
	Cadre d'ancrage desserré	Losser Verankerungsrahmen	Loosened anchorage frame	Marco de anclaje de desapriete	Quadro di ancoraggio allentato	Quadro de amarração solto	Отсоединенная анкерная рама
	Levage	Heben	Hoisting	Elevación	Sollevamento	Elevação	Подъем
	Distribution	Katzfahren	Trolleying	Distribución	Ditribuzione	Distribuição	Перемещение по стреле
	Orientation	Schwenken	Slewing	Orientación	Rotazione	Rotação	Поворот
	Translation	Kranfahren	Travelling	Traslación	Traslazione	Translação	Перемещение крана
	Puissance requise	Erforderliche Leistung	Required power	Potencia Necesaria	Potenza richiesta	Potência Necessária	Потребляемая мощность
	Voir télescope sur dalles	Siehe Kletterkrane im Gebäude	See climbing crane	Vea grua trepadora	Consultare gru in cavedio	Ver telescopagem sobre lages	См. кран, ползущий внутри здания
	Nous consulter	Auf Anfrage	Consult us	Consultarnos	Consultateci	Consultar-nos	Проконсультируйтесь у нас
	Document commercial non contractuel. Pour toute information technique se référer à la notice correspondante.	Unverbindliches Vertriebsdokument. Für technische Informationen, siehe die entsprechenden Anweisungen.	This commercial document is not legally binding. For any technical information, please refer to the corresponding instructions.	Documento comercial no contractual. Para cualquier información técnica, ver la noticia correspondiente.	Documento commerciale non vincolante, per tutte le informazioni tecniche fare riferimento al catalogo istruzioni.	Documento comercial não contratual. Para qualquer informação técnica complementar consultar as respectivas instruções.	Этот коммерческий документ не является юридически обязательным. Для получения технической информации, см. соответствующие инструкции.

