

National Series 800C



**An extra-heavy-duty telescoping crane from National,
America's truck-mounted hydraulic crane leader**

- Maximum Capacity: 62,000 Pounds (29.1 Metric Tons)
- Maximum Vertical Reach: 133 Feet (39.7 Meters)

National Series 800C

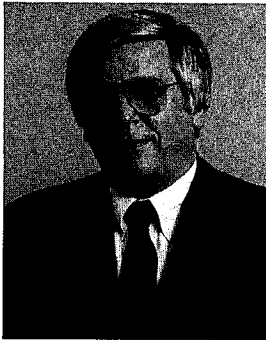

Dear Crane User:

National Crane is the world leader in the manufacture of truck-mounted hydraulic cranes because we have, from our inception, been committed to uncompromising standards and the unequalled performance of our products.

National cranes cost more to manufacture because our company invests more in materials, components, state-of-the-art manufacturing equipment, testing, technological research and development, and service support. We consider our investment as part of our unrelenting commitment to excellence - and to leadership! Because National invests more, you get more - substantially more - for every dollar that you spend for a truck-mounted hydraulic crane. That is the essence of value! Yet you will find that Nationals are surprisingly affordable and price competitive. Indeed, if you can afford a crane, you can afford a National. If you need a crane, you can afford nothing but a National.

Our all-new extra-heavy-duty Series 800C telescoping crane has been designed and manufactured in the National tradition. It is a crane of the highest quality, one that will give you years of reliable service. I encourage you to read this catalog carefully and thoroughly. I am confident that you will be impressed with the Series 800C and how it can serve your job requirements.

Sincerely,

A handwritten signature in dark ink, appearing to read 'T. J. Urbanek', written in a cursive style.

Ted Urbanek
President
National Crane Corporation

Why buy a National Series 800C?

National proudly presents the new Series 800C, top crane of its class in the commercial-truck-mounted industry. Consider these advantages:

Extra-heavy-duty lifting power

- The Series 800C is rated to lift up to 42,000 pounds (19.1 MT).

Extra-long vertical reach

- The National Series 800C reaches vertically to 90 feet under hydraulic power.
- With the 43-foot jib, the 800C reaches up to a height of 133 feet.

Field-proven durability

- National has manufactured cranes since 1963. Over 90% of all Nationals ever produced are still in operation.

Attention to quality

- National never skimps on quality. The materials and components used in the manufacture of National cranes often cost more - sometimes significantly more - than those found in competitive products. With a National, you get more for each dollar that you invest in a crane.

Industry-leading test program

- Each prototype model must pass the stringent test requirements of SAE J1063.
- National's test program subjects all prototype cranes to state-of-the-art stress coat and strain gauge testing, a procedure that measures metal deformation as small as one-millionth of an inch. These and the test procedures noted below verify the structural integrity of the cranes National manufactures.
- Prototype cranes must undergo National's life-cycle tests, the toughest in the industry. They receive more punishment than most cranes encounter in a lifetime of rigorous, on-the-job use. Every structural part of the crane is cycle tested. Some components are operated through 60,000 cycles at full capacity load. The process requires thousands of working hours and takes months to complete.
- Boom corner seam welds on all Nationals are ultrasonically tested to verify proper boom weld penetration.

Rigid quality controls

- Each Series 800C undergoes numerous quality inspections at all levels of manufacture and assembly. No crane is shipped without a rigid final inspection.

- Component manufacturers are critically reviewed by National's senior management before they qualify as suppliers of parts.
- Inspections of incoming materials and components ensure that purchased items meet National's standards.
- Material compositions are maintained and steel composition is regularly verified.
- All structural welders at National must pass AWS welder certifications.

More value for your investment

- Nationals consistently have the highest resale value in the industry. You will realize a greater return on your crane investment when you trade or sell your used National.

Responsive service and parts support

- Each Series 800C is backed by strong after sale and service support. National's professional dealer network is worldwide. That means service and repair resources are ever near, wherever you may be operating your National.
- The typical National dealer has been associated with National for more than eleven years. He knows the product.
- Authorized National dealers maintain a parts stocking program for

your crane. That means when your Series 800C needs parts or service, it will be back on the job without undue frustration or delay.

- When a dealer cannot immediately supply a part for your Series 800C, the factory can. National's back-up program provides 24-hour parts shipping in over 92% of all breakdown rush orders.

The National Service Center

- National maintains a fully equipped Service Center at the plant to handle factory crane mounting and special crane modifications or repairs. Most dealers can handle all but the most unusual or serious service/repair requirements.

The National Warranty

- The National Warranty covers your crane against defects in materials and workmanship for six months from the date of shipment, subject to the conditions of the warranty.

Efficient boom design

- Computer-aided design allows the crane to achieve higher lifting capacities by maximizing the weight efficiency of Series 800C booms.

National Series 800C (continued)

- The boom sections are fabricated from four high-strength steel members welded with perpendicular corners. This "box-section" design utilizes thicker top and bottom plates to enhance boom strength and thinner side plates to increase the crane capacity through lower boom weight.

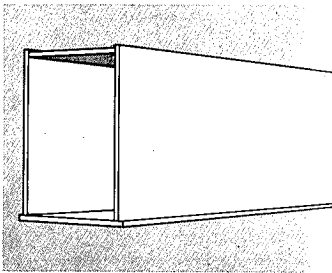

- Only high-strength, low-alloy steel is used in boom fabrication.
- Welds are made with automatic, low-hydrogen techniques to ensure strong fatigue-resistant seams.

Stronger, more efficient sheaves

- The sheaves on the Series 800C consist of iron, not plastic (as is used on most competitive cranes). Iron sheaves provide greater strength and longer wear, resist flange chipping, and help prevent core damage to the wire rope.
- Two lower sheaves in the sheave case allow for four-part reeving (with optional block) without attaching additional equipment at the end of the boom.

Four-section proportional boom extension system

- The Series 800C's four-section proportional boom, pioneered by National, sets up fast, provides extra-long hydraulic reach, and affords heavy-duty lifting power.
- Dual high-load-carrying cables cycle the fourth stage boom. All other sections are supported by the hydraulic cylinder. Redundant cable sets are used for durability and reliability. The internal bearings and cable require no lubrication.
- Proportional (cable crowd) boom design (each boom extends and retracts proportionally during the telescoping operation) provides more efficient boom weight distribution, maximizing boom operational efficiency and allowing higher capacities, particularly in normal working radii.

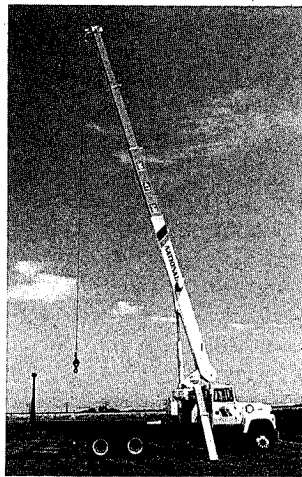

- The design permits minimum overlap to get the most reach with minimum retracted length. It reduces boom overhang (when the boom is stowed) and allows increased truck maneuverability.
- The use of cable (rather than chain) means more capacity, longer service life, and less maintenance.
- There are no fittings, tubes, or hoses inside the booms, and since the system utilizes only one extend cylinder, hydraulic maintenance is minimized.

"Easy Glide" boom wear pads

- Series 800C booms are equipped with National's all-new and unique "Easy Glide" wear pads*, a technology pioneered by National's engineering group.
- These pads reduce the conditions that cause noisy boom chatter and vibration.
- They feature an innovative self-lubricating capability that deposits and maintains a long-lasting film on boom sections and wear pad surfaces. This results in a smooth, reduced friction boom in/out movement during the extend/retract modes of operation - even at slow operating speeds.

**Patent Applied for*

- While these uniquely efficient wear pads do not completely eliminate the routine greasing of boom surfaces, they enhance a smooth and quiet crane operation, reduce wear and tear on the unit, reduce maintenance, and are easy to replace.
- The wear resistance of the material used in "Easy Glide" wear pads is unexcelled.

Direct mount holding valves

- On the Series 800C, all load-carrying cylinders are equipped with a direct mount holding valve for protection in the event of hose failure. The quiet, smooth, and stable new boom cylinder holding valve ensures a precise load placement capability with the boom.

National-manufactured cylinders

- Because National controls the manufacture of its own lift, outrigger, and stabilizer cylinders and the packing used as the seals, standardization is ensured and seal replacements fit properly.

High performance planetary winch

- The standard high-performance gear drive winch increases efficiency, requires less horsepower, and generates less heat.
- The Series 800C winch is powered by a premium, high-efficiency orbit (geroller) motor instead of the typical gear motor used on competitive cranes. The orbit motor used with National's high performance winch, allows for extra-smooth control, up or down, even under maximum load.
- Anti-friction roller bearings have replaced bronze bushings, and spring-loaded lip seals have replaced O-rings to reduce leaks and maximize winch efficiency.
- A "Burst-of-Speed" feature for faster, more efficient pay-out and pick-up of unloaded cable is standard. The "Burst-of-Speed" winch circuitry increases line speed up to 60% over normal.
- The high capacity winch used on the Series 800C features high line pull and fast standard speed (see the winch data chart on page 9).
- Standard brake and counterbalance valves provide fine control.
- The winch cover permits visibility of the drum and cable.

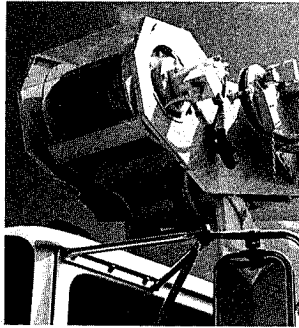

- Die-drawn rotation-resistant wire rope (cable) is standard on the 800C. Even under full load, die-drawn wire rope minimizes spinning and twisting. Lifting operations are more precise and no time is wasted untangling the line. Die-drawn cable has a longer usable life span.

Anti-two-block system

- The Series 800C is equipped with a standard anti-two-block system. Two blocking occurs when the winch cable and attachments contact the underside of the jib sheave case, whether by winching up or extending the boom without paying out the winch cable.

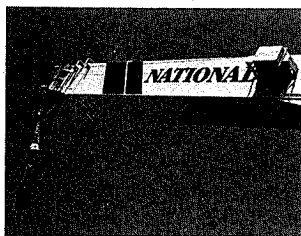

When this happens, the cable can be damaged by crimping or overextending. The anti-two-block attachment helps prevent cable damage by sensing the

position of the winch cable end attachments with respect to the sheave case and shutting down the functions that can cause two-blocking.

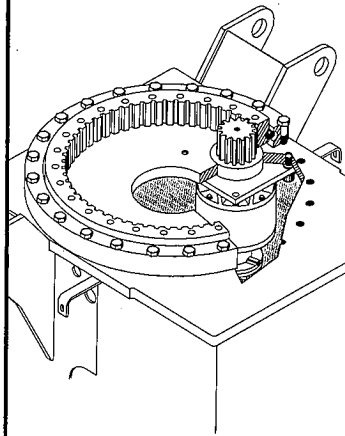

Positive planetary turret rotation

- The planetary rotation gearbox with a hydraulic release brake and a slip-through feature allows the gearbox to backdrive when excessive side load is applied to the boom, reducing shock loads on the upper and lower crane structure and gearbox. This feature helps protect the rotation system against damage from accidental side loading.
- The turret drive is designed with extra heavy bearings below the drive pinion. The turntable bearing full-circle bolt pattern extends the bearing life due to uniform loads on the bearing.
- The gearbox and rotation bearing mounting surfaces are precision machined after welding to ensure consistent tooth alignment for smooth rotation and low wear, even under maximum loads.
- The entire turret glides smoothly on a low-inertia ball bearing race.
- Rotation is 375° non-continuous. The rotation stop design eliminates the sudden stop on noncontinuous rotation machines by gradually slowing the rotation of the boom.

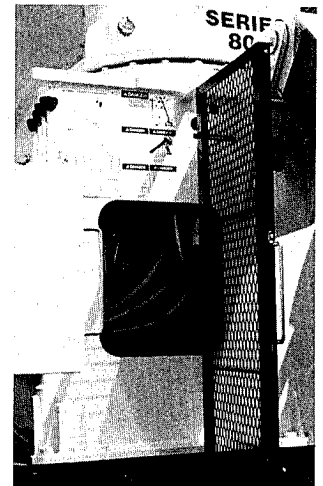

National Series 800C (continued)

Solid, reliable stability

- Wide 21-foot span A-frame out-and-down outriggers provide stable, efficient leveling, even on uneven ground. Large 18- by 18-inch outrigger pads are standard.

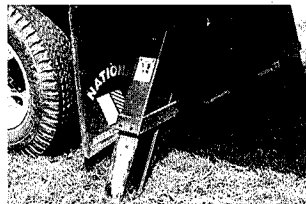

- The outriggers retract smoothly without binding under load, first moving up, then in.
- The outrigger and stabilizer hydraulic power is sufficient to level a fully loaded truck.
- With less truck weight you can carry larger payloads more economically.
- The 800C is equipped with ASH rear hydraulic stabilizers with a 10-foot (3.07m) span.
- Series 800C stabilizers are designed to lift and level – or lower – a loaded truck without sticking or binding. Hoses are routed along the beam to prevent hose damage during operation of the crane.
- Stabilizer foot pad size is 6.5 x 11 inches. Leg travel is 23 inches, permitting good penetration with maximum ground clearance.
- A precision-mounted level indicator aids the operator in leveling the unit during the set-up procedure.

National's "Out-and-down" Stable Outriggers CRANE

Outrigger Movement
Arch Outward
and Down

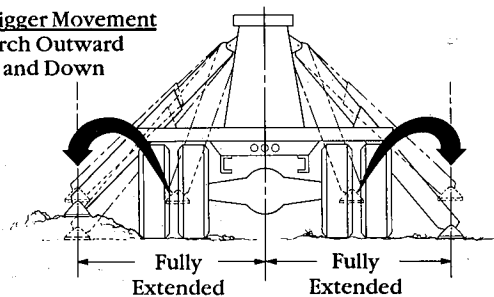

- Outriggers equally spaced from crane center line.
- Consistent outrigger span
- Crane will be equally stable on both sides.
- No skidding the foot into position.

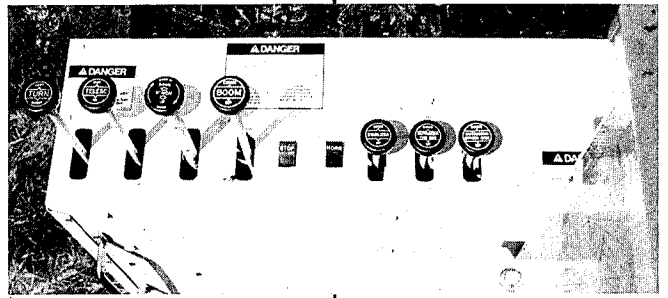

Smooth, "operator friendly" crane controls

- Dual controls are standard on the Series 800C. Identical crane function controls are located on each side of the crane. The controls are in an SAE recommended orientation of functions. That means that you always work the same control with the same hand.
- Dual stations provide more efficient operation of the crane and allow greater load visibility.
- Control rods supported by nylon bearings permit smooth operation of the crane and reduce lubrication requirements.
- National's control valves are custom manufactured to maximize the efficiency of each crane function. They afford the ultimate in fine metering and low spool force. The operator can winch a capacity load up or down in small increments of distance and can control all crane functions precisely and smoothly.
- The main control valve and the lift cylinder holding valve are designed to complement one another, minimizing boom bounce and hydraulic noise.
- Labeled knobs make it easy for the operator to determine the function of each control.
- The pressure gauge on the console permits the operator to monitor the hydraulic system pressure to ensure maximum performance.
- The 800C provides a precise leveling indicator at each control station. The level bubble brackets are machined to be parallel with the turntable bearing to properly level the unit prior to operation.
- A foot throttle, horn, and stop switch are located at each control station.
- The operator's stations are positioned to allow

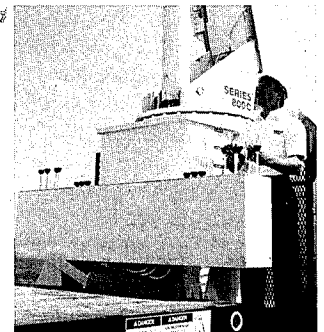

easy reading of the angle indicator showing the boom angle during operation.

- The platforms are located to give the operator excellent visibility of the load as well as convenient access to the bed. They are designed with open-mesh expanded metal to minimize dirt and mud buildup.
- Extra high back rests at operator control stations aid in operator control and comfort.

Heavy-duty hydraulic system

- A standard high-pressure, high-speed balanced vane replaceable tandem pump provides for a smooth, fast, simultaneous operation. The winch is isolated from other crane functions to provide an independent operation capability. The vane pump is more efficient and less costly to repair than the gear pumps used by some competitors.
- Control valve spools are hard, chrome-plated for long life and resistance to corrosion. All spools are selected and honed-fitted for minimum internal leakage and for maximum load-holding ability.

Unitized mounting

- National's unitized mount includes a one-piece, 8.75-inch deep subbase that extends along the frame and supports the crane and bed. It reduces counterweighting and increases stiffness and stability.
 - Reinforcing is not required on trucks with 15.9 inch³ * section modulus frames of 110,000 PSI minimum yield steel. The crane and subbase ship separately, then bolt together to form one solid integrated unit.
- *20.0 inch³ for 360° stability*

Lower truck requirements

- The Series 800C is engineered to lower your truck requirements. The wide outrigger span, ASH rear stabilizers, and unitized mount take the stress (and not the truck).
- That means that the 800C can mount on trucks with lower axle ratings and still meet DOT and stability standards with ease. It all adds up to lower maintenance, lower costs, and longer truck life for you.
- The Series 800C with subbase mounts on most standard, heavy-duty commercial trucks without requiring counterweight. In fact, the 800C capacities are 25% larger than the Series 875B, yet it mounts on

a smaller truck and the completed unit weighs less than its predecessor.

Easy service, low downtime

- The console cover allows easy access to control valves.
- Boom pivot and lift cylinder bearings provide longer life and lower maintenance.
- Boom access holes provide easy access to wear pads and holding valve for easy maintenance.
- The rotation drive and the brake are located inside the frame. A large access hole allows easy access for service.
- O-ring face seal fittings are used on all high pressure circuits to minimize fluid leakage.
- Main pins are chromed

to inhibit rust and allow easy removal.

- Greaseless bearings are used throughout to reduce maintenance.
- Extra-capacity (75-gallon) oil reservoir with sight gauge, breather, suction strainer, clean-out, and magnetic plug reduces heat buildup and keeps the hydraulic oil clean, ensuring ease of maintenance and long life. The aluminum reservoir prevents the gathering of rust in the system.

Versatile accessories

- A selection of boom/jib combinations (see next page) allows you to tailor your Series 800C to your job needs.
- A complete accessory line adds to the versatility of the Series 800C. See page 14 for details.

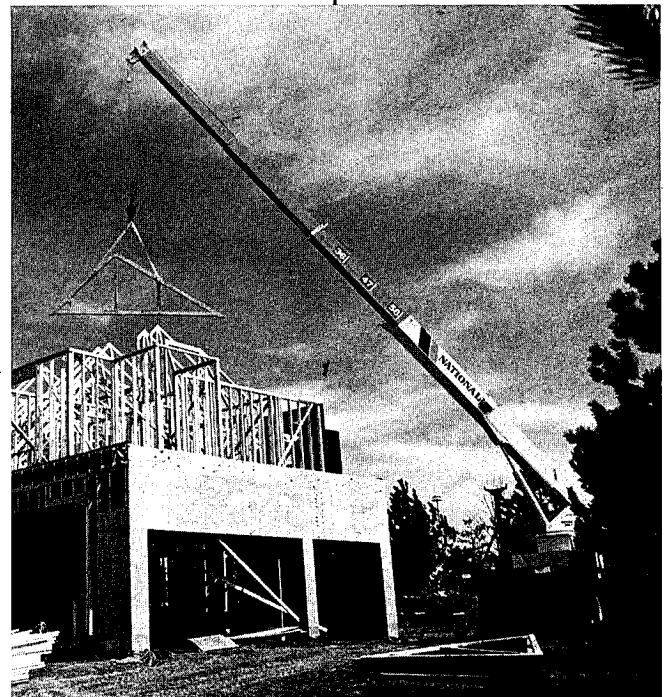

National Series 800C Booms and Jibs

Boom and Jib Combination

Note: An angling jib (8FJ15A) is available for Models 869C and 880C

869C: 27-69 ft. three section



869C: 27-69 ft. three section

8FJ27: 27 ft. single section



869C: 27-69 ft. three section

8FJ48M: 21-48 ft. manual pullout



880C: 24½-80 ft. four section



880C: 24½-80 ft. four section

8FJ24: 24½ ft. single section



880C: 24½-80 ft. four section

8FJ43M: 21-43 ft. manual pull-out



Reaches to 133 feet

The Series 800C is available in two basic models:
1. 869C with a 27-69 foot three-section boom. This

model reaches to a height of 122 feet when equipped with a 48-foot jib. It reaches to a height of 79 feet hydraulically.



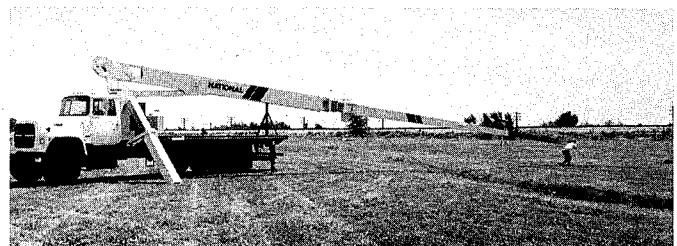
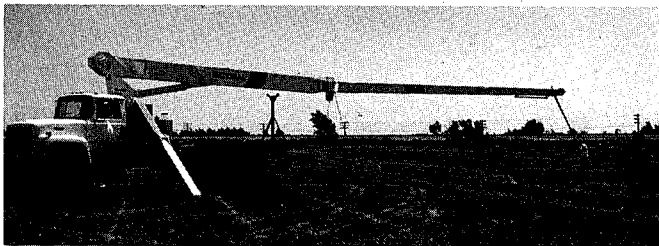
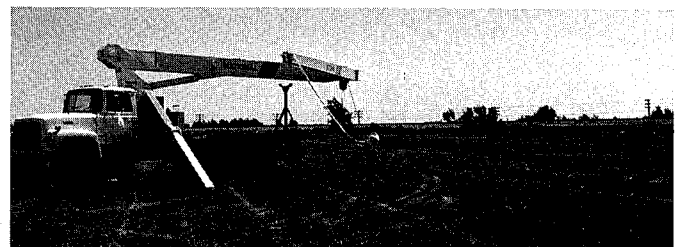
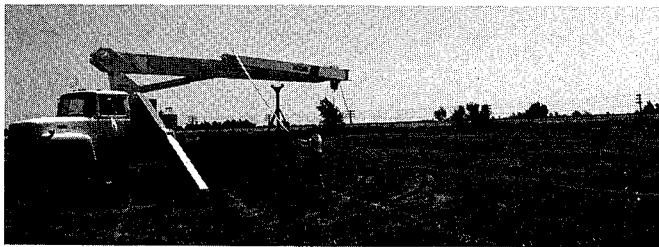

2. 880C with a 24.5-80 foot four-section boom. This model reaches to a height of 133 feet when equipped with the 43-foot

jib. It reaches to a height of 90 feet hydraulically. Both models are available with the optional jibs shown in the chart above.

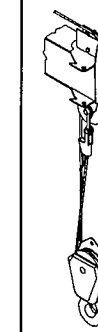

This sequence of photos shows how a National jib folds out into a working position.

National Series 800C Winch Data

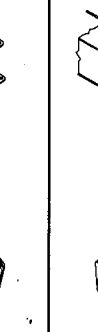
NATIONAL SERIES 800C WINCH DATA			1 Part Line	2 Part Line	3 Part Line	4 Part Line	5 Part Line	6 Part Line
CAUTION <ul style="list-style-type: none"> Do not deadhead lineblock against boom tip when extending boom. Keep at least three wraps of loadline on drum at all times. Use only 9/16" diameter rotation resistant cable with 38,500 pounds breaking strength on this machine. Maximum capacity with "Burst-of-Speed" is 3,000 pounds. 								
Winch	Cable Supplied	Average Breaking Strength	Lift and Speed	Lift and Speed	Lift and Speed	Lift and Speed	Lift and Speed	Lift and Speed
Standard Planetary Winch	9/16" diameter rotation resistant 19 x 7 IWRC	38,500 lbs.	7,700 lbs. 164 fpm	15,400 lbs. 82 fpm	23,100 lbs. 55 fpm	30,800 lbs. 41 fpm	38,500 lbs. 33 fpm	42,000 lbs. 27 fpm
	Optional 9/16" diameter 6 x 25 IWRC	29,750 lbs.	7,700 lbs. 164 fpm	15,400 lbs. 82 fpm	23,100 lbs. 55 fpm	30,800 lbs. 41 fpm	38,500 lbs. 33 fpm	42,000 lbs. 27 fpm
with "Burst-of-Speed" Feature	Same as corresponding cable data shown above		3,000 lbs. 265 fpm	6,000 lbs. 133 fpm	9,000 lbs. 88 fpm	12,000 lbs. 66 fpm	15,000 lbs. 53 fpm	18,000 lbs. 44 fpm

All winch pulls and speeds are shown on the fourth layer. Winch pulls would increase on the first, second and third layers. Winch line pulls would decrease on the first, second and third layers. Winch line pulls may be limited by the winch capacity or the cable safety factor. These are shown below:

Winch	Bare Drum Pull	Allowable Cable Pull
With standard rotation resistant rope	10,000 pounds	7,700 pounds
With optional 6 x 25 IWRC rope	10,000 pounds	8,400 pounds

Do not operate crane booms, jib extensions, any accessories, or loads within 10-feet (3m) of live power lines or other conductors of electricity

1. Load ratings shown on the following load rating charts are maximum allowable loads with the outriggers properly extended on a firm, level surface and the crane leveled and mounted on a factory-recommended truck.

2. Always level the crane with the level indicator located on the crane frame.
3. The operator must reduce loads to allow for factors such as wind, ground conditions, operating speeds, and the effect of freely suspended loads.

4. Overloading this crane may cause structural collapse or instability.
5. Weights of any accessories attached to the boom or loadline must be deducted from the load chart capacities.
6. Do not exceed jib capacities at any reduced boom lengths.

National Series 800C Load Rating Charts

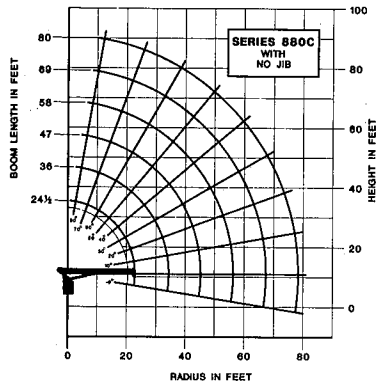

LOAD RATINGS												
LOAD RADIUS (FEET)	LOADED BOOM ANGLE	24 1/2 FT BOOM (LBS)	LOADED BOOM ANGLE	38 FT BOOM (LBS)	LOADED BOOM ANGLE	47 FT BOOM (LBS)	LOADED BOOM ANGLE	58 FT BOOM (LBS)	LOADED BOOM ANGLE	69 FT BOOM (LBS)	LOADED BOOM ANGLE	80 FT BOOM (LBS)
5	77.5	42,000										
8	70	29,200										
10	64.5	24,500	73.5	22,400	78	20,800						
12	58.5	21,200	70	19,200	75.5	17,700	78.5	16,400				
14	52.5	18,500	66.5	16,800	73	15,600	76.5	14,300	79.5	13,300		
16	46	16,200	63	14,800	70	13,700	74.5	12,700	77.5	11,800	79.5	11,400
20	29	12,500	55	12,100	64.5	11,200	70	10,300	74	9,700	76.5	9,200
25			44	9,700	57.5	9,100	65	8,400	69.5	7,700	72.5	7,300
30			31	7,800	50	7,800	59	6,900	65	6,400	68.5	6,050
35					41	6,300	53	5,900	60	5,600	64.5	5,100
40					30	5,100	46.5	5,000	55	4,700	60.5	4,400
45							38.5	4,300	49.5	4,100	56.5	3,850
50							29	3,500	43.5	3,500	52	3,350
55							13	2,400	37	3,000	47	2,900
60									29	2,500	41.5	2,500
65									17	1,800	35.5	2,100
70											28	1,700
75											18	1,200

LOADLINE EQUIPMENT DEDUCT

DOWNHAUL WEIGHT = 150
ONE SHEAVE BLOCK = 200
TWO SHEAVE BLOCK = 355
THREE SHEAVE BLOCK = 530

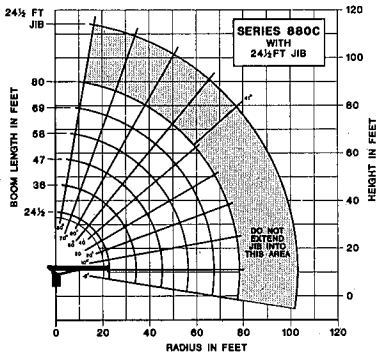

LOAD RATINGS												LOAD RADIUS (FEET)	LOADED BOOM ANGLE	24 1/2 FT JIB (LBS)	
LOAD RADIUS (FEET)	LOADED BOOM ANGLE	24 1/2 FT BOOM (LBS)	LOADED BOOM ANGLE	38 FT BOOM (LBS)	LOADED BOOM ANGLE	47 FT BOOM (LBS)	LOADED BOOM ANGLE	58 FT BOOM (LBS)	LOADED BOOM ANGLE	69 FT BOOM (LBS)	LOADED BOOM ANGLE	80 FT BOOM (LBS)			
5	77.5	42,000											20	79.5	5,800
8	70	29,200											25	77	4,900
10	64.5	24,500	73.5	22,200	78	20,600							30	74	4,300
12	58.5	20,900	70	19,000	75.5	17,500	78.5	16,200					35	71	3,650
14	52.5	18,200	66.5	16,600	73	15,900	76.5	14,100	79.5	13,200			40	68	3,100
16	46	15,800	63	14,700	70	13,500	74.5	12,600	77.5	11,700	79.5	11,300	45	65	2,600
20	29	12,200	55	11,900	64.5	11,000	70	10,100	74	9,800	76.5	9,100	50	62	2,200
25			44	9,500	57.5	8,900	65	8,200	69.5	7,800	72.5	7,200	55	59	1,800
30			31	7,400	50	7,300	59	6,700	65	6,300	68.5	6,950	60	55.5	1,600
35					41	6,100	53	5,700	60	5,400	64.5	5,000	65	52	1,350
40					30	4,900	46.5	4,800	55	4,600	60.5	4,300	70	48.5	1,100
45							38.5	4,100	49.5	4,000	56.5	3,750	75	45	850
50							29	3,300	43.5	3,400	52	3,250	80	41	650
55							13	2,200	37	2,900	47	2,800	85		
60									29	2,400	41.5	2,400	90		
65									17	1,700	35.5	2,000			
70											28	1,800			
75											18	1,100			

LOADLINE EQUIPMENT DEDUCT
DOWNHAUL WEIGHT = 150
ONE SHEAVE BLOCK = 200
TWO SHEAVE BLOCK = 355
THREE SHEAVE BLOCK = 530

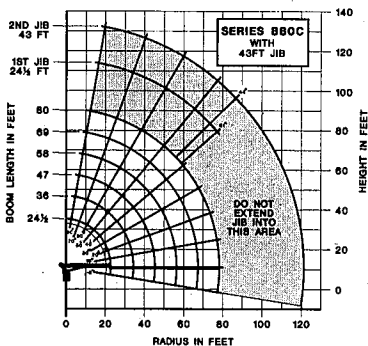

LOAD RATINGS													LOAD RADIUS (FEET)	LOADED BOOM ANGLE	24 1/2 FT JIB (LBS)	LOADED BOOM ANGLE	43 FT JIB (LBS)
LOAD RADIUS (FEET)	LOADED BOOM ANGLE	24 1/2 FT BOOM (LBS)	LOADED BOOM ANGLE	38 FT BOOM (LBS)	LOADED BOOM ANGLE	47 FT BOOM (LBS)	LOADED BOOM ANGLE	58 FT BOOM (LBS)	LOADED BOOM ANGLE	69 FT BOOM (LBS)	LOADED BOOM ANGLE	80 FT BOOM (LBS)					
5	77.5	42,000											20	79.5	5,800		
8	70	29,200											25	77	4,900	79	3,360
10	64.5	24,500	73.5	22,200	78	20,800							30	74	4,300	77	3,000
12	58.5	20,900	70	19,000	75.5	17,500	78.5	16,200					35	71	3,650	75	2,650
14	52.5	18,200	66.5	16,600	73	15,900	76.5	14,100	79.5	13,200			40	68	3,100	72.5	2,400
16	46	15,800	63	14,700	70	13,500	74.5	12,600	77.5	11,700	79.5	11,300	45	65	2,600	70	2,200
20	29	12,200	55	11,900	64.5	11,000	70	10,100	74	9,800	76.5	9,100	50	62	2,200	67.5	2,000
25			44	9,500	57.5	8,900	65	8,200	69.5	7,800	72.5	7,200	55	59	1,800	65	1,800
30			31	7,400	50	7,300	59	6,700	65	6,300	68.5	6,950	60	55.5	1,600	62.5	1,600
35					41	6,100	53	5,700	60	5,400	64.5	5,000	65	52	1,350	60	1,400
40					30	4,900	46.5	4,800	55	4,600	60.5	4,300	70	48.5	1,100	57	1,200
45							38.5	4,100	49.5	4,000	56.5	3,750	75	45	850	54	1,000
50							29	3,300	43.5	3,400	52	3,250	80	41	650	51	860
55							13	2,200	37	2,900	47	2,800	85			48	700
60									29	2,400	41.5	2,400	90			44	550
65									17	1,700	35.5	2,000					
70											28	1,800					
75											18	1,100					

LOADLINE EQUIPMENT DEDUCT
DOWNHAUL WEIGHT = 150
ONE SHEAVE BLOCK = 200
TWO SHEAVE BLOCK = 355
THREE SHEAVE BLOCK = 530

The capacities shown will be reduced when accessories are attached to the boom or loadline. Rated loads do not exceed 85% of the tipping load. Structural strength ratings in the charts below are shaded.

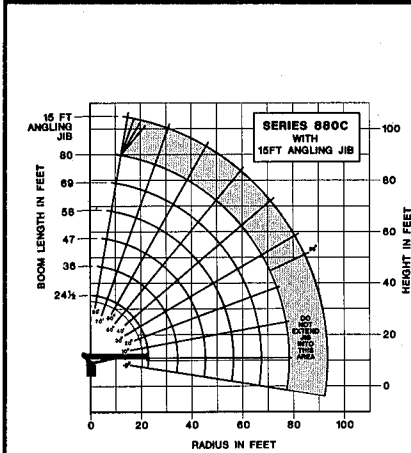

LOAD RATINGS											
LOAD RADIUS (FEET)	LOADED BOOM ANGLE	24FT BOOM (LBS)	LOADED BOOM ANGLE	39FT BOOM (LBS)	LOADED BOOM ANGLE	47FT BOOM (LBS)	LOADED BOOM ANGLE	58FT BOOM (LBS)	LOADED BOOM ANGLE	69FT BOOM (LBS)	
5	77.5	42,000									
8	70	29,200									
10	64.5	24,200	73.5	22,200	78	20,800					
12	58.5	20,900	70	19,000	75.5	17,500	78.5	16,200			
14	52.5	18,200	66.5	16,800	73	15,300	78.5	14,100	79.5	13,200	
16	46	15,900	63	14,700	70	13,500	74.5	12,500	77.5	11,700	
20	29	12,200	55	11,900	64.5	11,000	70	10,100	74	9,800	
25			44	9,500	57.5	8,900	65	8,200	69.5	7,800	
30			31	7,400	50	7,300	59	6,700	65	6,300	
35					41	6,100	53	5,700	60	5,400	
40					30	4,900	48.5	4,800	55	4,800	
45							38.5	4,100	49.5	4,000	
50							29	3,300	43.5	3,400	
55							13	2,200	37	2,900	
60									29	2,400	
65									17	1,700	
70										18	1,800
75											1,100

MAIN BOOM ANGLE					RATED LOAD (LBS)
LOAD RADIUS (FEET)	JIB IN LINE	JIB OFFSET 10°	JIB OFFSET 21°	JIB OFFSET 30°	
20	79	79.5			6,000
25	76	76.5	78	79	5,000
30	73	73.5	75	78	4,500
35	70	70.5	71.5	72.5	4,050
40	66.5	67	68	69	3,600
45	63	63.5	64.5	65.5	3,150
50	59.5	60	61	62	2,750
55	55.5	56	57	58	2,400
60	51.5	52	53	54	2,050
65	47.5	48	49	49.5	1,750
70	43	43.5	44.5	45	1,500
75	38	38.5	39.5	40	1,225
80	32	33	33.5	34	950
85	25	26	26	26	690

LOADLINE EQUIPMENT DEDUCT
 DOWNHAUL WEIGHT = 150
 ONE SHEAVE BLOCK = 200
 TWO SHEAVE BLOCK = 355
 THREE SHEAVE BLOCK = 530

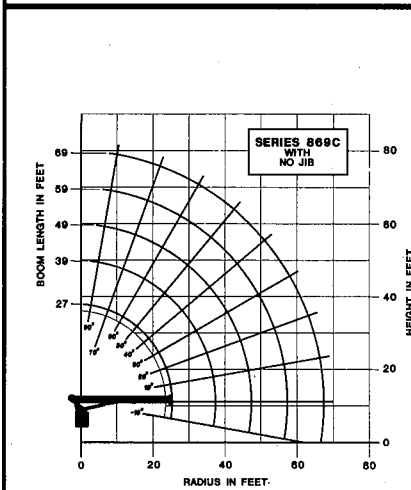

LOAD RATINGS										
LOAD RADIUS (FEET)	LOADED BOOM ANGLE	27FT BOOM (LBS)	LOADED BOOM ANGLE	39FT BOOM (LBS)	LOADED BOOM ANGLE	49FT BOOM (LBS)	LOADED BOOM ANGLE	59FT BOOM (LBS)	LOADED BOOM ANGLE	69FT BOOM (LBS)
5	79	42,000								
8	72	28,800								
10	67	23,800	75	21,800	78.5	20,800				
12	62	20,100	72	18,600	78	17,400	79	16,800		
14	57	17,500	68.5	16,100	73.5	15,100	76.5	14,300	78	13,700
16	51.5	15,600	65	14,300	71	13,300	74.5	12,800	77	12,100
20	38.5	12,200	58.5	11,800	66	10,800	70.5	10,200	74	9,700
25			49	9,200	59	8,850	65	8,200	69.5	7,800
30			37.5	7,400	51.5	7,180	59.5	6,750	65	6,400
35			21	5,500	43.5	6,000	53.5	5,700	60	5,400
40					33.5	4,900	47	4,850	54.5	4,850
45					19	3,800	39.5	4,150	49	4,000
50							31	3,450	43	3,450
55							17.5	2,600	38.5	2,900
60									28.5	2,400
65									18	1,700

LOADLINE EQUIPMENT DEDUCT

DOWNHAUL WEIGHT = 150
 ONE SHEAVE BLOCK = 200
 TWO SHEAVE BLOCK = 355
 THREE SHEAVE BLOCK = 530

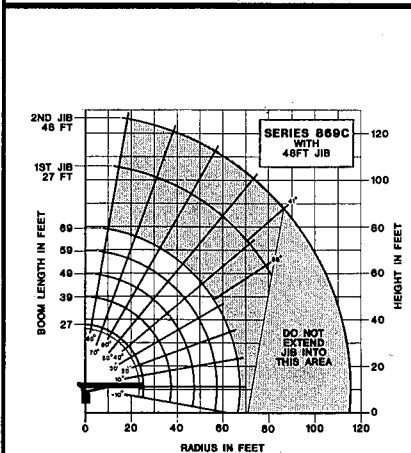

LOAD RATINGS										
LOAD RADIUS (FEET)	LOADED BOOM ANGLE	27FT BOOM (LBS)	LOADED BOOM ANGLE	39FT BOOM (LBS)	LOADED BOOM ANGLE	49FT BOOM (LBS)	LOADED BOOM ANGLE	59FT BOOM (LBS)	LOADED BOOM ANGLE	69FT BOOM (LBS)
5	79	42,000								
8	72	28,200								
10	67	23,200								
12	62	19,700	75	21,600	78.5	20,400	79	16,400		
14	57	17,100	72	16,200	76	17,200	76.5	14,100	79	13,600
16	51.5	15,100	68.5	15,800	73.5	14,800	74.5	12,400	77	12,000
20	38.5	11,800	65	14,000	71	13,100	70.5	10,000	74	9,800
25			58.5	11,300	66	10,800	65	8,000	69.5	7,700
30			49	8,900	59	8,450	59.5	6,550	65	6,300
35			37.5	7,100	51.5	6,950	53.5	5,600	60	6,300
40			21	5,200	43.5	5,800	47	4,850	54.5	4,550
45					33.5	4,700	39.5	3,950	49	3,900
50					19	3,400	31	3,250	43	3,350
55							17.5	2,300	38.5	2,800
60									28.5	2,300
65									18	1,800

LOADLINE EQUIPMENT DEDUCT

DOWNHAUL WEIGHT = 150
 ONE SHEAVE BLOCK = 200
 TWO SHEAVE BLOCK = 355
 THREE SHEAVE BLOCK = 530

National Series 800C Truck Specifications

Mounting Configurations	Configuration 1 with Torsion Box	Configuration 2 with Torsion Box
	<p>The versatility of the Series 800C can be enhanced by the mounting configurations described at the right. The configurations are based on the Series 800C with an 85% stability factor. The complete unit must be installed in accordance with factory requirements and a test performed to determine actual stability and counterweight requirements since individual truck chassis vary.</p>	<p>This configuration is the least expensive method for the Series 800C. This mount, with the crane mounted behind the cab, requires the least weight of all mounts for stability, thus, you can haul larger payloads on your truck. It requires standard subbase and rear (ASH) stabilizers.</p>
Stable	180°	360°
Gross Axle Weight Rating (GAWR), front	12,000 lbs.	12,000 lbs.
Gross Axle Weight Rating (GAWR), rear	34,000 lbs.	34,000 lbs.
Wheelbase (WB)	222 inches	222 inches
Cab to axle/trunnion (CA/CT)	144 inches	144 inches
Frame Section Modulus (SM) under crane 50,000 PSI or	35.0 inch ³	Not applicable (see note above)
110,000 PSI	15.9 inch ³	20.0 inch ³
Frame Section Modulus (SM) over rear stabilizers: 50,000 PSI or	17.0 inch ³	Not applicable (see note above)
110,000 PSI	13.0 inch ³	13.0 inch ³
Stability Weight, Front	6,800 lbs. minimum* 7,400 lbs. maximum*	6,800 lbs. minimum* 7,300 lbs. maximum*
Stability Weight, Rear	9,100 lbs. minimum*	9,100 lbs. minimum*
Estimated Average Final Weight (880C)	35,000 lbs.	35,300 lbs.
<p>Notes:</p> <p>(1) GAWR means Gross Axle Weight Rating and is dependent on all components of the vehicle such as axles, tires, springs, frame, etc., meeting manufacturer's recommendations. Always specify GAWR when purchasing trucks.</p> <p>(2) Minimum axle requirements may increase with use of longer wheelbase, service bodies, diesel engines, or front stabilizers.</p> <p>(3) Diesel engines require variable speed governor and energize-to-run fuel solenoid for smooth crane operation.</p>	 	
*Estimated axle scale weights prior to installation of crane, stabilizers, and subbase for 85% stability.		

Configuration 3 with Torsion Box

The advantages of a rear-mounted Series 800C are: (1) allows the operator to effectively use the close-in work area to lift heavier loads; and (2) 360° stability at full-rated load. Hydraulic out-and-down outriggers located behind the cab are necessary to keep the total weight of the unit to a minimum with full stability. Requires front over frame outriggers, rear stabilizer, and heavy-duty rear-mount subbase.

360°

12,000 lbs.

34,000 lbs.

222 inches

156 inches minimum

35.0 inch³

15.9 inch³

35.0 inch³

15.9 inch³

6,800 lbs. minimum*
9,100 lbs. maximum*

8,200 lbs. minimum*

36,000 lbs.

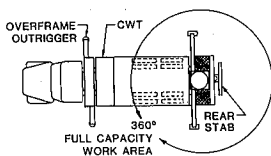
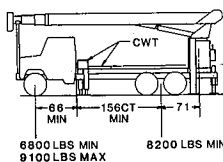

Truck Frame and Mounting Bolt Requirements for Front Stabilizer

The truck frame must have adequate strength from under the crane frame through the front suspension to the bumper assembly for front stabilizer installation. A truck frame yield strength of 110,000 psi is required.

The following diagram shows the required section modulus at various stations along the front end of the truck frame for a standard behind-the-cab mount.

Note in the sample cross-sections that the truck frame top flange width is decreased in the engine compartment area. Also note that almost half the truck frame channel is removed at the very front of the frame on the standard truck frame.

In order to safely mount a front stabilizer in place of the normal front bumper, a minimum bolt pattern as shown is required. The bracket must be capable of supporting .50 DIA, Grade 8 bolts to their nominal breaking strength. Torque the mounting bolts supplied with the front stabilizer to 110 ft-lb. Do not use spacers between the bumper bracket and the front stabilizer bumper assembly. If the bumper bracket and front of the truck frame do not meet these specifications, an extended frame truck must be used. Contact the factory for details. Details for mounting a stabilizer on an extended frame truck are included in the installation instructions. However, the Section Modulus requirements outlined above do still apply.

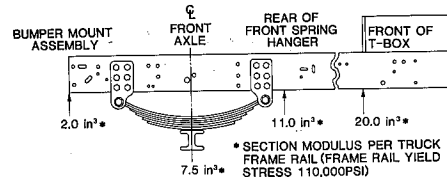

Standard Truck Frame -- for angled single front stabilizer only

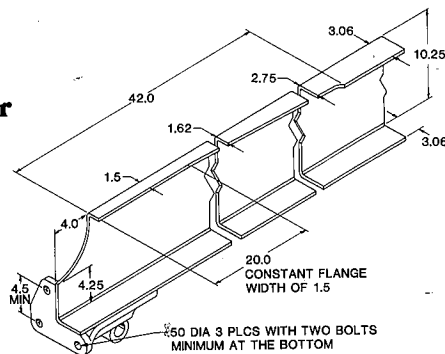

Extended Truck Frame -- for angled or straight down single front stabilizer

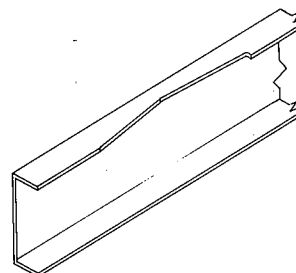

National Series 800C Accessories

Every Series 800C is part of the National Lifting System, a choice of accessories that add versatility to your crane. With National accessories you can tailor your crane to handle your specific job requirements. In many instances, a truck-mounted crane equipped with accessories can eliminate your need for other specialized equipment.

Because your 800C affords such versatility, you save time, money, and manpower. You can do more, faster, and with less equipment. National accessories are cost-efficient options.

Note:

Weights of all accessories attached to the boom or loadline of the crane must be deducted from the effective lifting capacity. Consult your National dealer for specific accessory availability. Some accessories cannot be used in combination with other accessories and/or certain boom/jib combinations.

Remote Control

National offers one-hand remote control for your Series 800C. Ideal where precise control and total load visibility are required.

Fine metering and instant response mean operators can position loads or work platforms easily.

National's remote controls are built with solid-state circuitry and few moving parts. They are designed for reliability. You will be impressed with the high operating speeds and modular design.

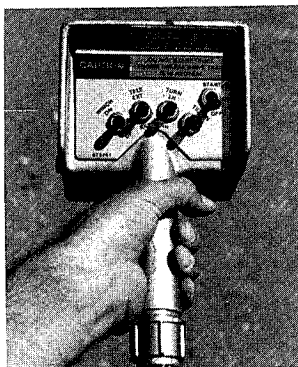

Available in two models: R4 with tilt, turn, telescope and winch functions, and R3 with tilt, turn and telescope only. R3 is to be used to control cranes from boom-attached platforms and baskets.

A priority control valve, operated by a trigger on the remote control unit, regulates oil flow and gives you fingertip speed control over all crane functions.

National's remote control is lightweight and easy-to-use. Consult your dealer or the factory for availability.

Model R3

Tilt, turn and telescope

Model R4

Tilt, turn, telescope and winch

Capacity Alert System

National offers two capacity alert options. The audible-visual capacity alert system is designed to alert the operator when he reaches a maximum capacity condition on the crane structure. This system activates the truck horn when capacity load is exceeded on the main boom.

The hydraulic capacity alert system is a hydraulically operated, maximum

capacity sensing device that is designed to stop all of the normal crane functions that cause overload when maximum capacity is exceeded on the main boom. Neither of these systems is applicable to jib and stability capacities.

Model AAS

(Audible capacity alert system)

Model HAS

(Hydraulic capacity alert system)

One Person Basket

Strong, lightweight fiberglass basket with 300-pound capacity puts personnel where you want them for tough maintenance and installation jobs. Optional dual basket brackets for two-basket operation on main boom. Easy on-off. Safety belts included. With basket(s) attached to the crane, the crane must not be operated at a position where the crane load chart shows less than the following capacities:

- One fiberglass basket - 550 pounds
- Two fiberglass baskets - 1,100 pounds

Model B1

Model B1-L

With lock

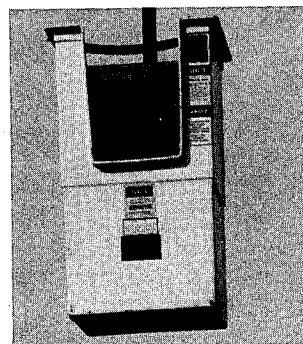

Heavy-duty Personnel Basket

New high-capacity steel personnel basket provides a rated lifting capacity of 1,200 pounds and safety loops to secure up to four passengers.* Dimensions are 72"x42"x42". Ideal for simultaneously lifting personnel, tools, and materials to above-the-ground job sites. A new fast-attachment system allows fast, easy pinning of basket to the boom. The gravity-leveling basket has a new, secure disc-brake locking system.

Model BSA-1

**This basket must not be used in load-rated areas where the crane load chart shows capacities less than 2,300 pounds.*



Caution

Do not operate crane booms, jib extensions, any accessories, or loads within 10 feet (3 m) of live power lines or other conductors of electricity.

Do not exceed jib capacities at any reduced boom lengths.

Personnel Platform

This extra strength 3x6-foot steel platform will carry up to 1,000 pounds and operate at working heights up to 90 feet. It is hydraulically self-leveling and protected by safety valves. Safety belts included. Fold down sides standard.

Optional manual rotator available for precise placement of the platform. Easy-to-operate crank rotates the platform through a dependable chain drive. Continuous rotation. Locks in position.

The personnel platform must not be operated in load rated areas where the load chart shows capacities less than 2,000 pounds on Model SLP and 2,200 pounds on Model SLPR. Can be used with angling jib for additional reach.

Model SLP
Model SLPR

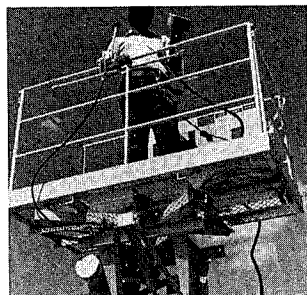

Three Pump System

This optional pump system provides three separate (or individual) hydraulic circuits for independent operation of winch, swing, and crane functions. The option increases productivity on high-cycle jobs and facilitates the ease of operation.

Stabilizers/ Outriggers

We offer a complete range of front and rear stabilizers with hydraulic vertical and horizontal motion. All cylinders are fully enclosed for protection against dirt and on-the-job damage.

Stabilizers

	Rear Mounted (Model RSOD)	Front Mounted* (Model SFO Fixed, Model SFOA Fixed)
Vertical Travel.....	25.5"	25"
Ground Penetration (38" Frame Height).....	10"	13"
Operation.....	All-Hydraulic	All-Hydraulic
Span.....	14'	Single
Controls.....	Both stabilizers noted above can be operated from either control station.	

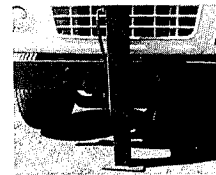
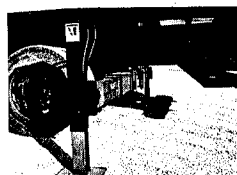

Cross-frame Outriggers

Extended Span.....	15'6"
Retracted Span.....	7'11"
Vertical Travel	
Over-Frame.....	25"
Under-Frame.....	18"
Ground Penetration (38" Frame Height)..	10"
Mounting Space	
Outrigger Only.....	24"

Model 8HO

**The SFO and SFOA are both single front-mounted hydraulic stabilizers. Neither is designed to lift the vehicle, but both models will provide stability for the vehicle after it has been leveled. Model SFO is for use only on extended chassis frame. SFOA is for use on standard frame truck.*

Hydraulic Oil Cooler

Automatic hydraulic device designed to cool the hydraulic oil under high-cycle operation.

Model HOC

Pallet Fork

Turns your Series 800C into a versatile, payload-packing fork lift. Great for delivering palletized material right where you want it. 4,400 lbs. (1,996 kg) capacity with adjustable throat and teeth. Handles most loads with ease.

Capacity.....	4,400 lbs. at 20" center
Throat opening.....	41" to 65" (adjustable)
Tooth Length.....	38"
Tooth Width.....	33.5" to 57" (outside to min. max. outside)
Weight.....	350 lbs.

Model MKF

(Manual leveling, adjustable throat)



Loose Material Clam Bucket

Increase the flexibility of your Series 800C with a National clam bucket. Use this versatile accessory to load or move up to 2/3 cubic yard of loose materials with each bite. Hooks easily to loadline, comes with hydraulic hose on automatic reel and quick-connect fittings. Extension hoses are required for use with jibs. Just position the load where you want it and open the bucket.

Model LMC

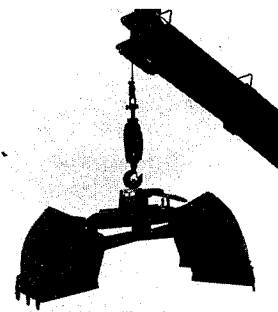

National Series 800C Specifications

General Construction:

Low-alloy, high tensile, and other steel including T-1, Ex-Ten, Stressproof and Hi-Yield are combined with special low-hydrogen welding techniques wherever advantageous. Standard color: painted National Ivory.

Frame:

Box construction for maximum strength and rigidity.

Turret:

Fabricated rigid structure, well-braced for stability. Line-bored and machined after welding to ensure proper alignment.

Rotation:

375° rotational force 342,000 in./lb. Turret rotation is by hydraulic orbit motor and planetary gearbox driving a pinion. The turret rotates on a ball-bearing race. Spring-applied hydraulic release brake provides positive, no-drift lateral positioning.

Subbase:

Unitized box construction designed to increase torsional stiffness and reduce truck frame requirements. Standard subbase is designed to fit on standard 34" wide truck frame and will accommodate a 20' stringerless bed.* Attaches both to truck frame and crane frame. Total depth of subbase is 8.75".

**Requires longer wheel-base truck with 14,000 pound GAWRF.*

Outriggers:

"A" frame box-type 21' span (center of pad at ground level) moves out-and-down, will not bind when raising or lowering truck. Can be positioned to 10.5" below ground level on 38" truck frame height.

Tilt:

Double-acting hydraulic cylinder raises and lowers boom; butt-mounted safety holding valve prevents boom falling in event of hose failure. Heavy-duty, long-life pivot bearings.

Boom:

Boxed construction; telescopes proportionally under rated load on nylon plates impregnated with molybdenum disulfide for smooth, long-life operation. Boom cylinder and valves are easily serviced. Heavy-duty, long-life pivot bearings. "Easy Glide" wear pads reduce noisy boom "chatter" and vibration, enhance smooth and quiet operation, are easy to replace, and reduce wear and maintenance.

Winch:

Hydraulic geroller motor with planetary gear reduction brake and counterbalance valve for "power down" load lowering. 10,000 pounds bare drum single-line pull available with 320 feet of 9/16 inch, 19.25 ton breaking strength loadline. "Burst-of-Speed" control increases payout and pick-up of unloaded cable 60% over normal operating speed.

Rear Stabilizer

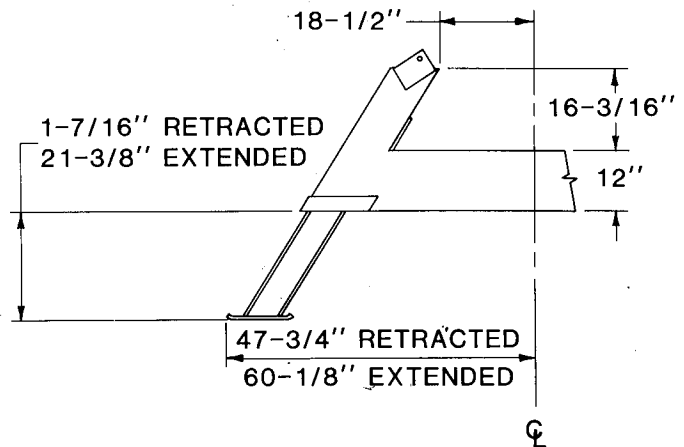

Pumps:

Tandem Vickers, high-pressure, high-speed balanced-vane, replaceable cartridge-type, providing 23 gpm to crane functions and 34 gpm to winch.

Cylinders:

Shaft packing: Polyurethane cup type. Shafts: Hi-Yield stress-relieved, chrome-plated. Piston sets: Polyurethane U-cups with glass reinforced nylon bearings. Cylinder barrels: Micro-honed tubing and safety check valves.

Valves:

Four-way, spring-centered, spool-type with low spool force and extra-fine metering notches. Independent relief valves protect hydraulic circuit against overload. Relief valves set at 2,650 psi (3,050 psi on winch system). Valves located for improved accessibility and ease of service.

Hose:

All high-pressure hose is wirebraid reinforced, having a minimum safety factor of 4 to 1

Operating Speeds:

Winch 3rd wrap: 150 fpm. Boom up and down: 23-27 seconds. Boom out: 47 fpm. Boom in: 49 fpm. Turn: 42 seconds. When using remote control, crane function speeds will be reduced by 40% to assure smooth operation. (Speeds above assume no load with 23 gpm oil flow on boom and 34 gpm on winch.)

Oil Tank Capacities:

75-gallon supply tank with breather, clean-out, suction strainers and removable magnetic plug.

National Boom Rests

Dimensional Specification

Series	Retracted Length	Extended Length	G	Dry* Wt/Lb	With Oil* Wt/Lb
880C	24.5 ft.	80 ft.	87 in.	17,750*	18,500*
869C	27 ft.	69 ft.	90 in.	17,400*	18,150*

*Weight includes all items except ASH (600#).

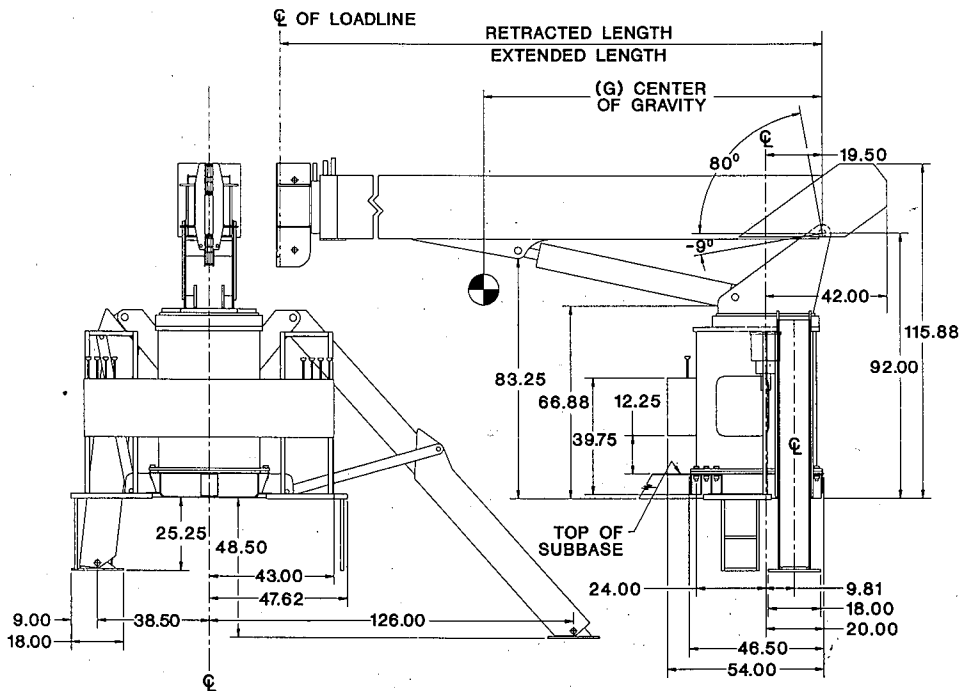
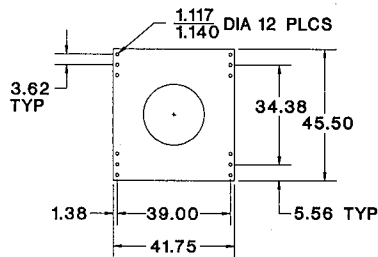

Cranes are tough when they are in use, but they can be severely damaged during travel from job to job. The only way a crane can be protected from this type of wear and damage is a strong, solid boom rest.

Boom Rests

- Add years to the life of your crane
- Reduce stress on the crane frame
- Protect rotation gear from transit damage
- Remove stress from truck frame
- Spread crane load more evenly
- Reduce maintenance and downtime

In addition, boom rests are required to provide a positive way to immobilize your crane for transit.

National Crane supplies two heavy-duty boom rests for strong, sure protection of your crane. There is a quality National boom rest to fit your mounting configuration. All National cranes must be fitted with a boom rest. All factory mounted cranes will be supplied with a boom rest.

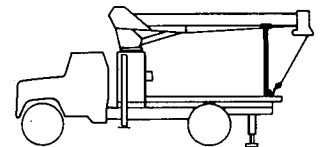

Horizontal rear bed mount for greater load space

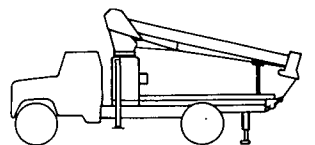

Low-profile rear bed mount for lower center of gravity

National Series 800C Proposal

Date _____	Description	Price
Prepared for: _____	1. Series _____	\$ _____
_____	2. Boom _____	_____
_____	3. Jib _____	_____
Submitted by: _____	4. Rear Stabilizers: <input type="checkbox"/> RSOD <input type="checkbox"/> HO <input type="checkbox"/> ASH	_____
_____	5. Front Stabilizers: <input type="checkbox"/> SFO <input type="checkbox"/> SFOA	_____
(Firm Name)	6. Line Block: <input type="checkbox"/> 2-3 Part <input type="checkbox"/> 4 Part <input type="checkbox"/> 5 Part <input type="checkbox"/> 6 Part	_____
_____	Accessories	_____
_____	7. _____	_____
_____	8. _____	_____
(Address)	9. _____	_____
_____	10. _____	_____
_____	Mounting	_____
(City and State)	11. Installation: Behind Cab <input type="checkbox"/> Std. <input type="checkbox"/> Special	_____
_____	12. Installation: Rear Mounting (add to installation charge above)	_____
(Zip)	<input type="checkbox"/> Air Throttle	_____
_____	<input type="checkbox"/> Rear Mounting Hydraulic Group	_____
(Phone)	<input type="checkbox"/> Heavy-duty Rear Mount Subbase	_____
Signed: _____	<input type="checkbox"/> Rear Outriggers	_____
_____	<input type="checkbox"/> HO Outriggers	_____
National reserves the right to change designs, prices, and specifications at any time without notice.	13. Frame Reinforcement: <input type="checkbox"/> Weld <input type="checkbox"/> Bolt-Extra	_____
	14. Platform Body _____ ft. <input type="checkbox"/> Wood <input type="checkbox"/> Steel	_____
	15. Weight in bed _____ lbs. (if required)	_____
	16. Boom Rest: <input type="checkbox"/> Parallel <input type="checkbox"/> Low <input type="checkbox"/> Other	_____
	17. Mount SFO or SFOA	_____
	18. Mount Stabilizers	_____
	19. Chassis	_____
	20. Rear Bumper Underride protection <input type="checkbox"/> Ordered <input type="checkbox"/> Not Ordered	_____
	21. Freight	_____
	This quotation will remain firm for _____ days.	_____
	Accepted by _____	\$ _____
	(Name)	TOTAL PRICE
	_____	_____
	(Firm Name)	(Date)



NATIONAL CRANE
A Grove Worldwide Company

Your National Dealer:

General Offices: 11200 North 148th Street / Waverly, NE 68462
Phone: 402/786-6300; FAX 402/786-6363

**Uncompromising Standards
Unequaled Performance**

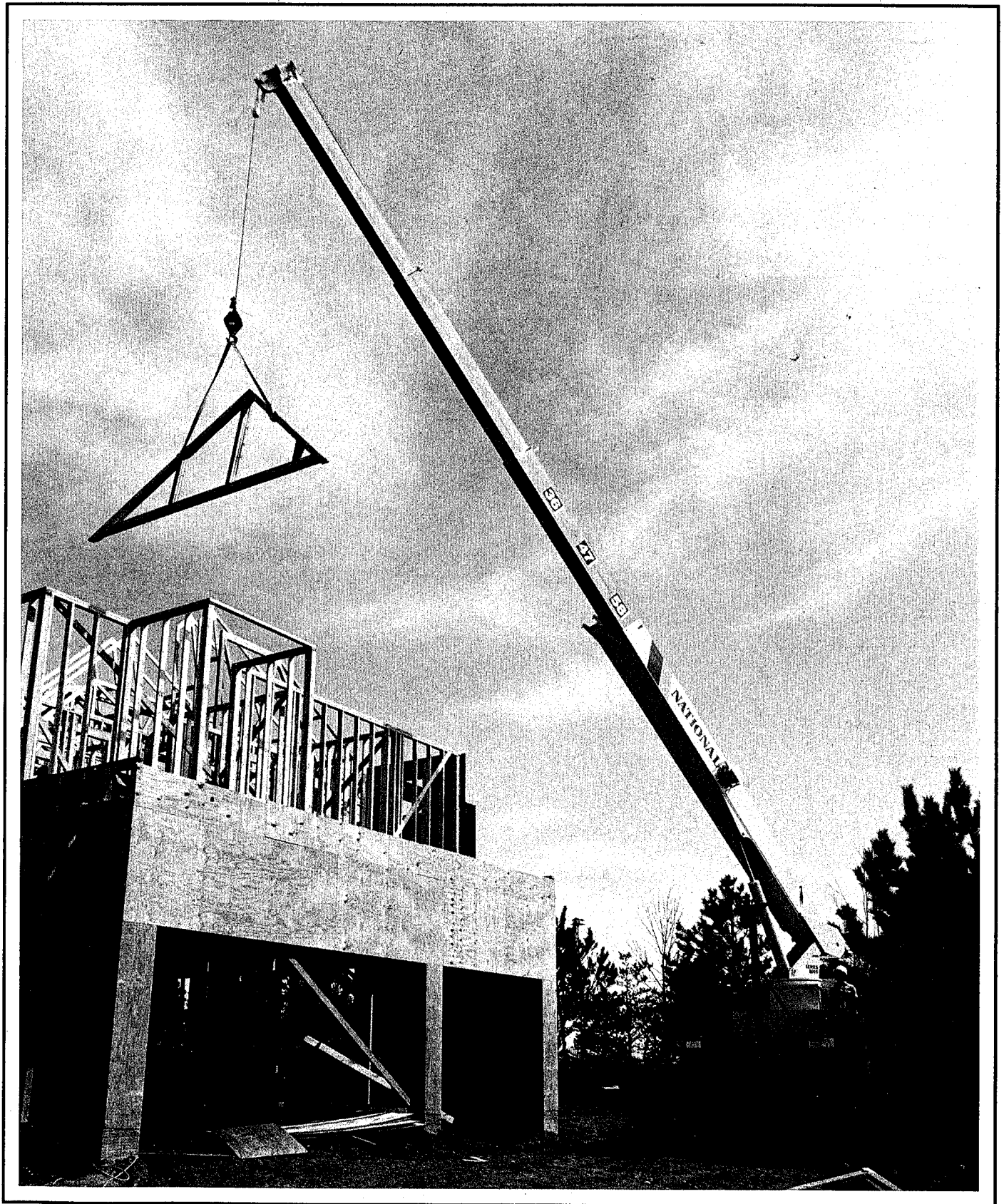

The Series 800C



from National Crane