

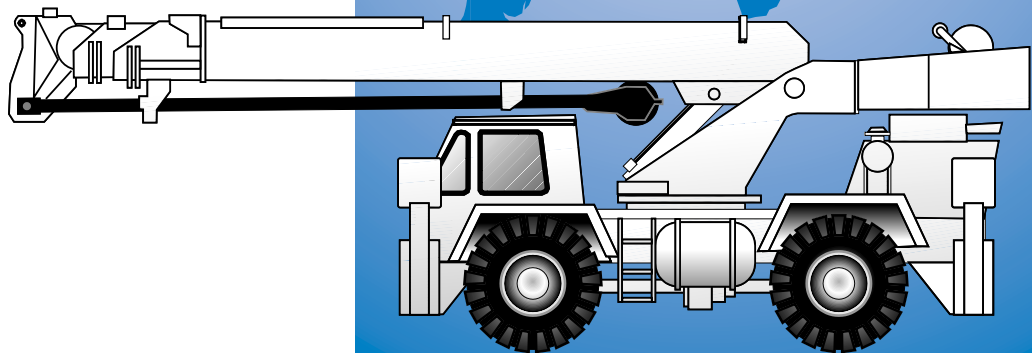

GROVE[®]
CRANE

A GROVE WORLDWIDE COMPANY

RT58C



Rough Terrain Hydraulic Crane

Dimensions

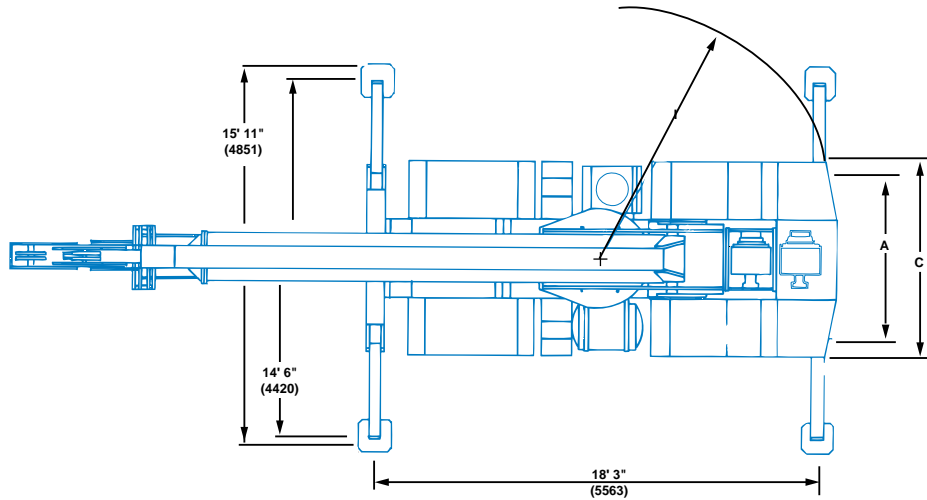

TIRE SIZE	17.5 X 25	20.5 X 25
A (TRACK)	6' 6" (1981)	6' 9" (2057)
B (O.A.H)	10' 5" (3175)	10' 9" (3277)
C (O.A.W)	8" (2438)	8' 3" (2667)
D (60' BOOM)	10' 6" (3200)	10' 9" (3277)
E (70' BOOM)	NA	11' 6" (3505)
F GROUND CLEARANCE	1' 1" (330)	1' 4" (406)
G (60' BOOM)	30' 5" (9271) w/o Aux. Hoist 32' 5" (9881) w/ Aux. Hoist	
H (70' BOOM)	35' 9" (10896)	
I (TAILSWING)	8' 5" (2565) w/o Aux. Hoist	
(60' BOOM)	10' 3" (3124) w/ Aux. Hoist	
(70' BOOM)	10' 3" (3124)	

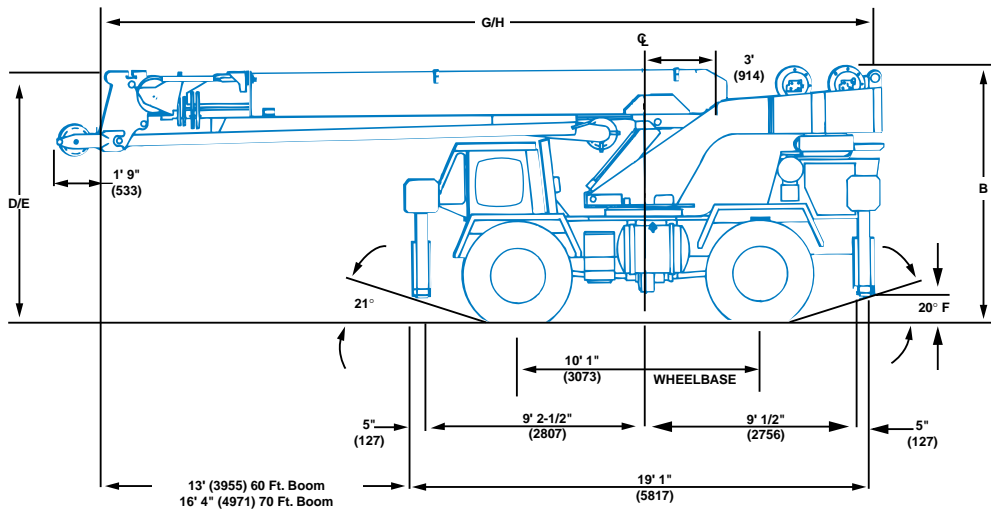

Turning Radius 16' 3" (4940 mm)

Front Axle Load 22,280 lbs. (10 100 kg)

Rear Axle Load 21,840 lbs. (9 9003 kg)

Gross Vehicle Weight 44,120 lbs. (20 000 kg)

Working Range



25-60 ft.
(7.6-18.3 m)

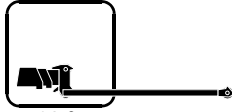

20 ft.
(6.1 m)

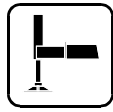

360°

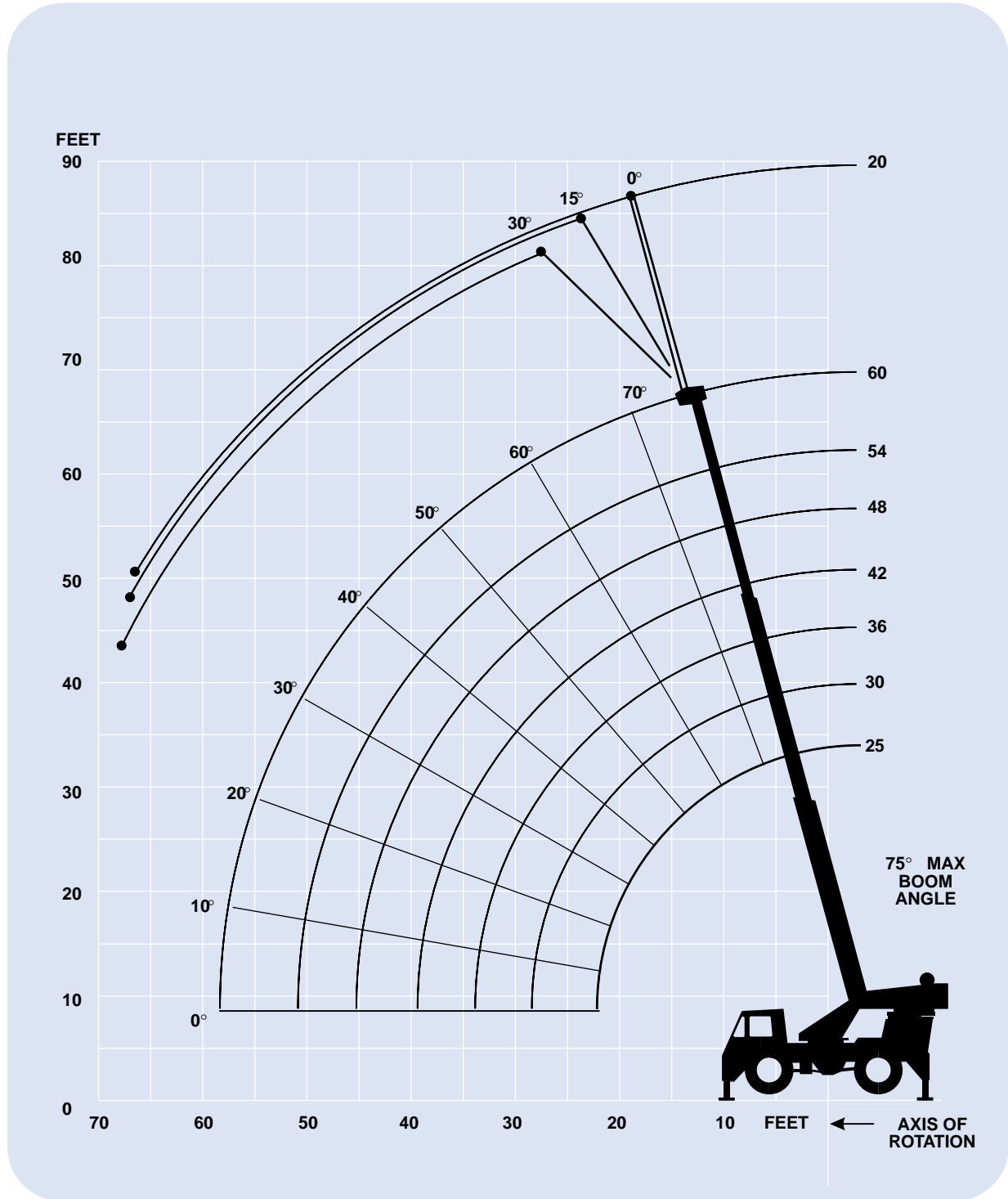

DIMENSIONS ARE FOR LARGEST GROVE FURNISHED HOOKBLOCK AND HEADACHE BALL, WITH ANTI-TWO BLOCK ACTIVATED.

Superstructure specifications

Boom

25 ft. - 60 ft. (7.6 m - 18.3 m) three-section full power-boom.

Maximum Tip Height: 66 ft. (20.1 m).

*Optional Jib (60 ft. Boom)

20 ft. (6.1 m) "A frame" jib offsettable at 0°, 15° or 30°. Stows beneath base boom section.

Maximum Tip Height: 85 ft. (25.9 m).

*Optional Boom

28 ft.- 70 ft. (8.6 m - 21.2 m) three-section full power boom.

Maximum Tip Height: 76 ft. (23.2 m).

*Optional Jib (70 ft. Boom)

23 ft. (7.0 m) "A frame" jib offsettable at 0°, 15° or 30°. Stows beneath base boom section.

Maximum Tip Height: 98 ft. (29.9 m).

Boom Nose

Three steel sheaves mounted on heavy duty tapered roller bearings with removable pin-type rope guards.

*Optional removable auxiliary boom nose with removable pin type rope guard.

Boom Elevation

Two double acting hydraulic cylinders with integral holding valve provides elevation from -0° to 75°.

Load Moment & Anti-Two Block System

Standard load moment and anti-two block system with audio-visual warning and control lever lockout. These systems provide electronic display of boom angle, length, radius, tip height, relative load moment, maximum permissible load and load indication and warning of impending two-block condition.

Cab

Full vision, all steel fabricated frame mounted with tinted safety glass throughout. Deluxe adjustable seat. Dash mounted control levers, gauges, for engine functions. Other standard features include: sliding side doors, electric windshield wash-wipe, circulating air fan, dome light, fire extinguisher, seat belt.

Swing

Ball bearing swing circle with 360° continuous rotation. Grove planetary drive with automatic multi-disc swing brake and plunger type mechanical house lock. Maximum speed: 2.9 RPM.

Counterweight

Bolted to turntable mast.

60 ft. (18.3 m) Boom:

With main only: 7,470 lbs. (3388 kg)

With main & aux. 5,710 lbs (2590 kg)

70 ft. (21.2 m) Boom:

All configurations: 10,170 lbs. (4613 kg)

Hydraulic System

Three main pumps with a combined capacity 112.5 GPM (426 LPM). Driven by carrier engine through P.T.O. Maximum operating pressure 2500 PSI (172 BAR).

*Optional pump disconnect with engine jogging switch.

Hoist Specifications

Main and Auxiliary Hoist

Power up and down equal speed, grooved drum, planetary reduction with automatic brake and hoist cable followers. Electronic hoist drum rotation indicators.

Maximum Single Line Pull: 9,640 lbs. (4372 kg)

Maximum Single Line Speed: 429 FPM (131 m/min)

Maximum Permissible Line Pull: 8,496 lbs. (3853 kg)

Rope Diameter: 5/8 in. (16 mm)

Rope Length: 350 ft. (106 m)

Maximum Rope Stowage: 486 ft. (148 m)

Carrier specifications

Chassis

Steel all welded box-type construction. Integral outrigger housings and front/rear towing and tie down lugs.

Outrigger System

Cantilever arm type at all four corners with integral check valves on each extension cylinder. Integral all steel outrigger float pads 13.5 in. (343 mm) square. Maximum outrigger pad load: 36,787 lbs. (16 687 kg).

Outrigger Controls

Controls and crane level indicator located in cab.

Engine

Cummins BT59L six cylinders, turbocharged, water cooled diesel, 125 bhp (93 kw) (Gross) @ 2,800 RPM. Maximum torque: 325 ft. lbs. (441 Nm) @ 1,700 RPM.

Fuel Tank Capacity

60 gallons (227 L)

Transmission

Remote mounted powershift with 6 forward and 6 reverse speeds, 3 in high range, 3 in low range. Rear axle disconnect for 4 x 2 travel.

Electrical System

Two 12-V - maintenance free batteries. 625 CCA@ 0°F 12-V starting.

Drive

4 x 4 or 4 x 2.

Steering

Fully independent power steering:
Front: Full hydraulic steering wheel controlled.
Rear: Full hydraulic tiller bar controlled.
Provides infinite variations of 4 main steering modes: front only, rear only, crab and coordinated.
Rear steer indicating gauge.

Axles

Front: Drive steer with differential and planetary reduction hubs rigid mounted to chassis.
Rear: Drive/steer with differential and planetary reduction hubs pivot mounted at center of chassis. Automatic full hydraulic lockouts on rear axle. *No-spin differential on rear axle.

Oscillation Lockouts

Automatic full hydraulic lockouts on rear axle permits oscillation only with boom centered over the front.
*Oscillation lockout override control.

Tires

Std. 17.5 x 25 - 20PR earthmover type, tubless.
*Optional: 20.5 x 25 -20PR., earthmover type, tubless.

Lights

Full lighting including turn indicators, head, tail, brake, and hazard warning lights.

Maximum Speed

24 MPH (38.0 kph).

Gradeability (Theoretical)

96.7% (Based on 49,000 lbs. [22 226] kg GVW)

Miscellaneous Standard Equipment

Full width steel fenders, electronic back-up alarm, light package, hourmeter, fire extinguisher, seat belts, air cleaner service indicator.

*Optional Equipment

- | | |
|---|--|
| *Auxiliary hoist | *Spare wheel |
| *Boom mounted work lights | *Tool kit |
| *360° flashing light | *LMI light bar |
| *Spotlights | *Cold start aid (less canister) |
| *Hot water heater | *Tachometer |
| *Hookblock/Headache ball | *A/V warning system, low oil pressure, high water temperature. |
| *Tow winch - front mounted maximum pull 15,000 lbs. (6804 kg); maximum speed 72 ft/min. (22m/min) | *360° positive swing lock |
| | *Integral toolboxes |



25 - 60 ft.
(7.6-18.3 m)



7,470 lbs.
(3388 kg)



100%



360°



85% Domestic (Pounds)

(Feet)	25	30	36	42	48	54	60
10	36,000	36,000	36,000	36,000			
12	34,500	34,500	34,500	34,300	33,500		
15	<u>28,000</u>	<u>28,000</u>	<u>28,000</u>	<u>28,000</u>	<u>28,000</u>	<u>27,600</u>	<u>25,000</u>
20	19,600	19,600	19,600	19,600	19,600	19,600	19,600
25		13,300	13,300	13,300	13,300	13,300	13,300
30			9,730	9,730	9,730	9,730	9,730
35				7,440	7,440	7,440	7,440
40					5,880	5,880	5,880
45						4,820	4,820
50						4,000	4,000
55							3,350

Minimum boom angle (degrees) for indicated length (no load)

0

Maximum boom length (ft.) at 0 degree boom angle (no load)

60

A6-829-004139



25 - 60 ft.
7.6-18.3 m)



7,470 lbs.
(3388 kg)



100%



Over Front



85% Domestic (Pounds)

(Feet)	25	30	36	42	48	54	60
10	36,000	36,000	36,000	36,000			
12	34,500	34,500	34,500	34,300	33,500		
15	28,000	28,000	28,000	28,000	28,000	27,600	25,000
20	<u>22,200</u>	<u>22,200</u>	<u>22,200</u>	<u>22,200</u>	<u>22,200</u>	<u>21,900</u>	<u>21,500</u>
25		<u>17,400</u>	<u>17,400</u>	<u>17,400</u>	<u>17,400</u>	<u>17,400</u>	<u>17,400</u>
30			<u>14,100</u>	<u>14,100</u>	<u>14,100</u>	<u>14,100</u>	<u>14,100</u>
35				<u>11,320</u>	<u>11,320</u>	<u>11,320</u>	<u>11,320</u>
40					9,010	9,010	9,010
45						7,470	7,470
50						6,200	6,200
55							5,100

Minimum boom angle (degrees) for indicated length (no load)

0

Maximum boom length (ft.) at 0 degree boom angle (no load)

60

A6-829-004140

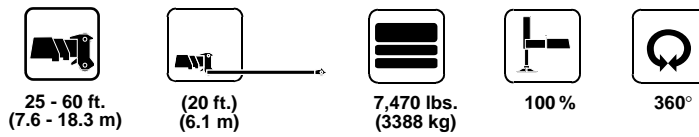

Boom Angle	0° OFFSET	15° OFFSET	30° OFFSET
75°	9,500	6,100	4,200
70°	8,400	5,450	3,870
65°	7,140	4,850	3,660
60°	5,440	4,400	3,500
55°	4,210	3,770	3,330
50°	3,410	3,200	3,200
45°	2,810	2,730	2,700
40°	2,440	2,360	2,360
35°	2,150	2,040	2,040
30°	<u>1,890</u>	<u>1,810</u>	<u>1,810</u>

A6-829-003405C

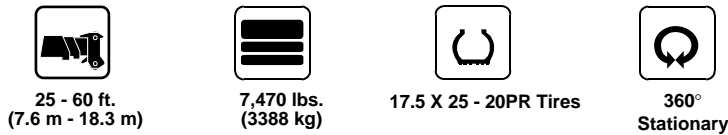

(Feet)	25	30	36	42	48	54
10	16,280					
12	13,000	10,000	10,000	10,000	10,000	
15	<u>9,000</u>	7,600	7,600	7,600	7,600	
20	5,290	<u>5,000</u>	<u>5,000</u>	5,000	5,000	5,000
25		3,440	3,440	3,440	3,440	3,440
30			2,440	2,440	2,440	2,440
35				<u>1,780</u>	<u>1,700</u>	1,700
40					1,220	<u>1,100</u>
45						820

A6-829-009191A

THIS CHART IS ONLY A GUIDE AND SHOULD NOT BE USED TO OPERATE THE CRANE. The individual crane's load chart, operating instructions and other instructional plates must be read and understood prior to operating the crane.



25 - 60 ft.
(7.6 - 18.3 m)



7,470 lbs.
(3388 kg)



17.5 X 25 - 20PR Tires



Defined Arc
Over Front
Stationary



75% Domestic (Pounds)

(Feet)	25	30	36	42	48	54	60
10	24,100						
12	22,060	16,000	16,000	16,000	10,000		
15	17,380	13,000	13,000	13,000	10,000		
20	11,340	9,600	9,600	9,600	9,600	9,600	
25		7,650	7,650	7,500	7,500	7,500	
30			5,660	5,660	5,660	5,660	5,660
35				4,340	4,340	4,340	4,340
40					3,410	3,410	3,410
45						2,750	2,750
50						2,180	2,150
55							1,600

A6-829-009166A



25-60 ft.
(7.6 m - 18.3 m)



7,470 lbs.
(3388 kg)



17.5 X 25 - 20PR Tires



Pick & carry
Up to 2.5 MPH



75% Domestic (Pounds)

(Feet)	25	30	36	42	48	54	60
10	24,750						
12	21,030	13,700	13,700				
15	16,830	11,100	11,100	11,100	11,100		
20	11,340	8,670	8,670	8,300	8,300		
25		7,650	7,650	6,400	6,400	6,400	
30			5,410	5,000	5,000	5,000	5,000
35				4,340	4,000	4,000	4,000
40					3,410	3,100	3,100
45						2,750	2,500
50						2,180	2,000
55							1,600

A6-829-009192A

Working Range



28-70 ft.
(8.6-21.2 m)

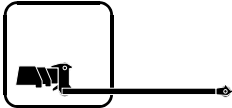

23 ft.
(7.0 m)

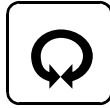
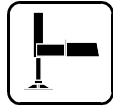

360°

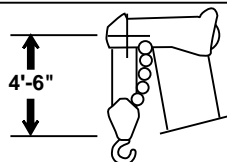
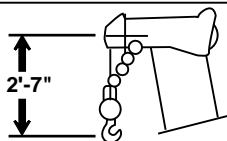
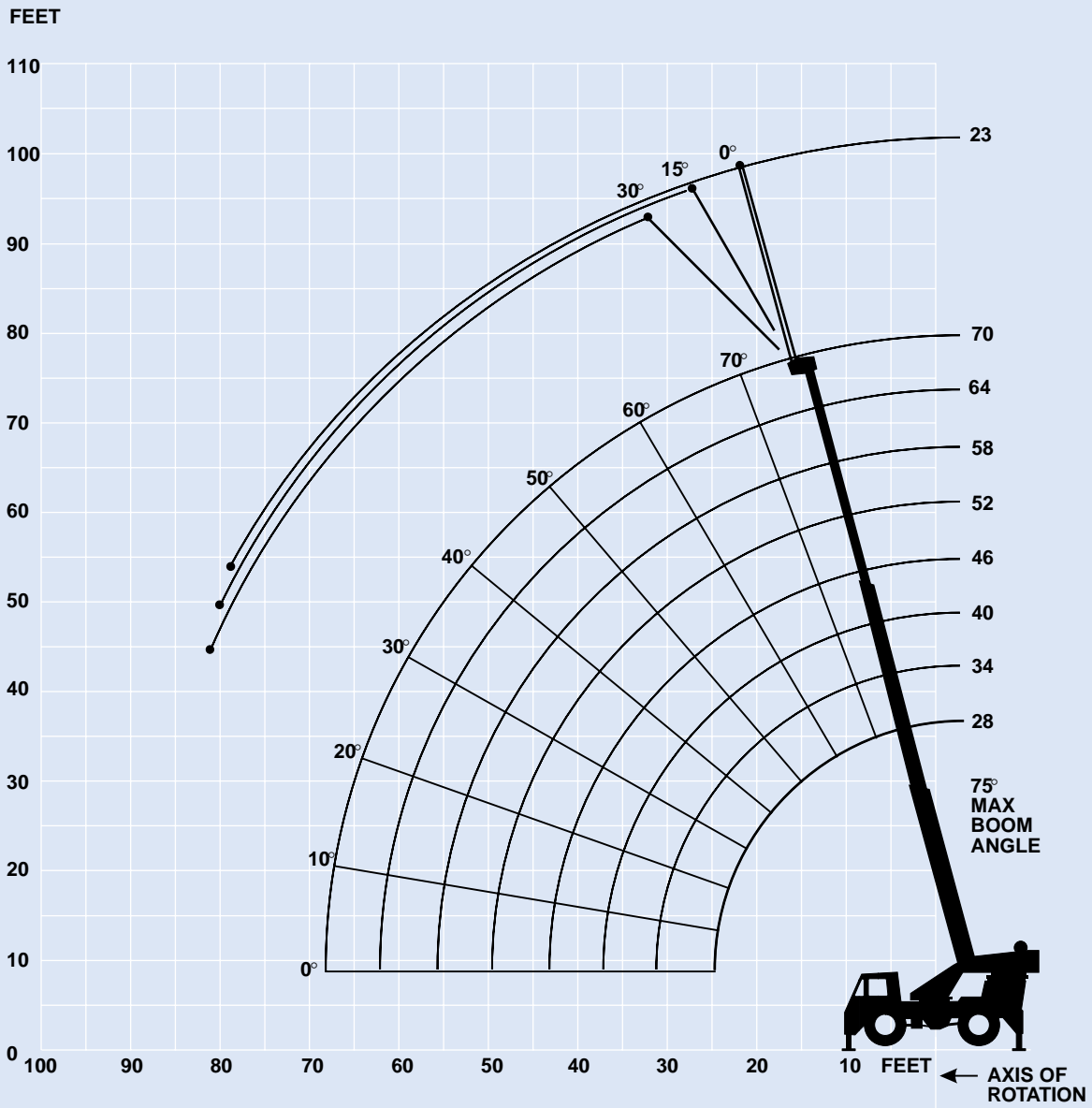

DIMENSIONS ARE FOR LARGEST GROVE FURNISHED HOOKBLOCK AND HEADACHE BALL, WITH ANTI-TWO BLOCK ACTIVATED.



28 - 70 ft.
(8.6 - 21.2 m)



10,170 lbs.
(4613 kg)



100%



360°



85% Domestic (Pounds)

(Feet)	28	34	40	46	52	58	64	70
10	36,000	35,350	34,350					
12	32,150	30,950	30,000	29,250				
15	27,100	26,100	25,200	24,500	23,950	23,500		
20	21,000	20,600	19,950	19,350	18,850	18,400	18,050	17,750
25		15,450	15,450	15,450	15,450	15,100	14,800	14,520
30			11,270	11,270	11,270	11,270	11,270	11,270
35				8,660	8,660	8,660	8,660	8,660
40					6,940	6,940	6,940	6,940
45						5,550	5,550	5,550
50							4,500	4,500
55							3,600	3,600
60								2,850
65								2,260

Minimum boom angle (degrees) for indicated length (no load)

0

Maximum boom length (ft.) at 0 degree boom angle (no load)

70

A6-829-004357



28 - 70 ft.
(8.6 - 21.2 m)



10,170 lbs.
(4613 kg)



100%



Over Front



85% Domestic (Pounds)

(Feet)	28	34	40	46	52	58	64	70
10	36,000	35,350	34,350					
12	32,150	30,950	30,000	29,250				
15	27,100	26,100	25,200	24,500	23,950	23,500		
20	21,000	20,600	19,950	19,350	18,850	18,400	18,050	17,750
25		16,600	16,350	15,900	15,500	15,100	14,800	14,520
30			13,530	13,350	13,050	12,750	12,450	12,200
35				11,250	11,150	10,950	10,700	10,500
40					9,540	9,480	9,320	9,140
45						8,160	8,140	8,020
50							6,870	6,870
55							5,740	5,740
60								4,770
65								3,910

Minimum boom angle (degrees) for indicated length (no load)

0

Maximum boom length (ft.) at 0 degree boom angle (no load)

70

A6-829-004342

28 - 70 ft.
(8.6 - 21.2 m)

(23 ft.)
(7.0 m)

10,170 lbs.
(4613 kg)

100%

360°

  **85% Domestic (Pounds)**

Boom Angle	0° OFFSET	15° OFFSET	30° OFFSET
75°	12,000	7,700	5,070
70°	8,160	7,000	4,800
65°	5,680	5,350	4,500
60°	4,310	4,220	3,620
55°	3,330	3,300	2,940
50°	2,720	2,580	2,390
45°	2,210	2,130	2,010
40°	1,750	1,690	1,680
35°	1,460	1,420	1,420
30°	<u>1,240</u>	<u>1,210</u>	<u>1,200</u>

A6-829-004378D

28 - 70 ft.
(8.6 - 21.2 m)

10,170 lbs.
(4613 kg)

20 X 25 - 20PR Tires

360°
Stationary



 **75% Domestic (Pounds)**

(Feet)	28	34	40	46	52	58	64
10	24,710	15,000	14,500				
12	<u>18,450</u>	13,500	12,100	12,100			
15	12,610	<u>12,100</u>	9,450	9,450	9,450		
20	7,290	7,290	<u>6,350</u>	6,100	6,100	6,100	6,100
25	4,780	4,780	4,780	<u>4,250</u>	4,250	4,250	4,250
30		3,350	3,350	3,350	<u>3,000</u>	3,000	3,000
35			2,410	2,410	2,410	<u>2,050</u>	2,050
40				1,690	1,690	1,690	<u>1,300</u>
45					1,050	1,050	<u>1,050</u>

A6-829-009270

THIS CHART IS ONLY A GUIDE AND SHOULD NOT BE USED TO OPERATE THE CRANE. The individual crane's load chart, operating instructions and other instructional plates must be read and understood prior to operating the crane.



28 - 70 ft.
(8.6 - 21.2 m)



10,170 lbs.
(4613 kg)



20.5 X 25 - 20PR Tires



Defined Arc
Over Front
Stationary



75% Domestic (Pounds)

(Feet)	28	34	40	46	52	58	64	70
10	31,300	20,500	18,500					
12	27,500	18,500	16,500	16,500				
15	22,300	16,500	14,000	14,000	14,000			
20	13,940	13,940	10,500	10,500	10,500	10,500	10,500	
25	9,160	9,160	8,000	8,000	8,000	8,000	8,000	
30		6,850	6,850	6,250	6,250	6,250	6,250	6,250
35			5,180	5,180	4,950	4,950	4,950	4,950
40				4,020	4,020	3,900	3,900	3,900
45					3,140	3,140	3,050	3,050
50						2,430	2,430	2,350
55						1,860	1,860	1,750
60							1,440	1,440
65								1,140

A6-829-009269



28-70 ft.
(8.6 m - 21.2 m)



10,170 lbs.
(4613 kg)



20.5 x 25 - 20PR Tires



Pick & carry
Up to 2.5 MPH



75% Domestic (Pounds)

(Feet)	28	34	40	46	52	58	64	
10	28,470	18,000	18,000					
12	24,550	15,500	15,500	15,500				
15	20,420	12,500	12,500	12,500	12,500			
20	13,940	10,500	8,500	8,500	8,500	8,500	8,500	8,500
25	9,160	9,160	6,500	6,500	6,500	6,500	6,500	6,500
30		5,670	5,670	4,950	4,950	4,950	4,950	4,950
35			4,430	4,430	3,900	3,900	3,900	3,900
40				3,510	3,050	3,050	3,050	3,050
45					2,760	2,350	2,350	2,350
50						2,120	1,750	1,750
55						1,580	1,580	1,580
60								1,180

A6-829-009271





































Rated lifting capacities

Important Notes:

Warning: THIS CHART IS ONLY A GUIDE.
 The notes below are for illustration only and should not be relied upon to operate the crane. The individual crane's load chart, operating instructions and other instruction plates must be read and understood prior to operating the crane.

1. All rated loads have been tested to and meet minimum requirements of SAEJ1063 - Cantilevered Boom Crane Structures - Method of Test, and do not exceed 85% of the tipping load on outriggers (75% of the tipping load on rubber) as determined by SAEJ765 Crane Stability Test Code.
2. Capacities given do not include the weight of hookblocks, slings, auxiliary lifting equipment and load handling devices. Their weights must be added to the load to be lifted. When more than minimum required reeving is used, the additional rope weight shall be considered part of the load.
3. Capacities appearing above the bold line are based on structural strength and tipping should not be relied upon as a capacity limitation.
4. All capacities are for crane on firm, level surface. It may be necessary to have structural supports under the outrigger floats or tires to spread the load to a larger bearing surface.
5. When either boom length or radius or both are between values listed, the smallest load shown at either the next larger radius or boom length shall be used.
6. For outrigger operation, ALL outriggers shall be fully extended with tires raised free of ground before raising the boom or lifting loads.

Symbols Glossary

	Frame		Steering
	Outriggers		Transmission
	Outrigger Controls		Axles
	Engine		Brakes
	Fuel Tank Capacity		Tires
	Electrical System		Suspension
	Drive		360° Rotation
	Lights		Boom Elevation
	Cab		Swing
	Boom		Counterweight
	Fixed Swingaway		Oil
	Tele-Swingaway		Hydraulic System
	Jib		Hoist
	Boom Nose		Radius
	Boom Extension		Boom Length
	Speed		Hookblock
	Grade		Gear
	Lattice Extension		Luffing Jib

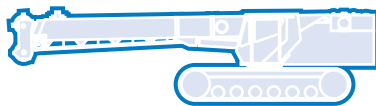
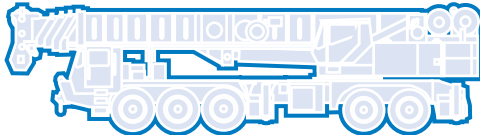
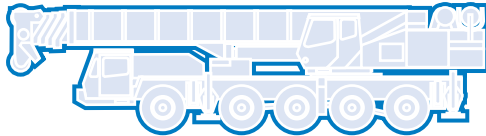
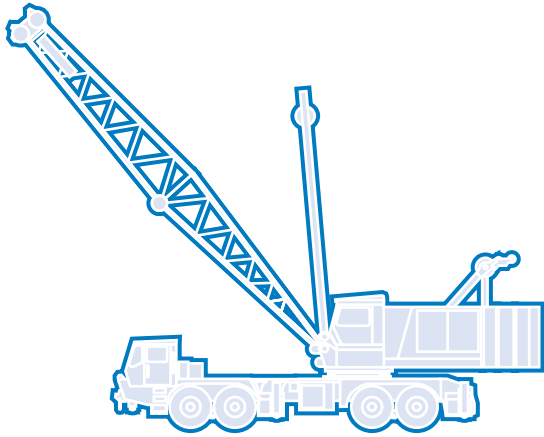

Grove Worldwide – World Headquarters

Grove North America
1565 Buchanan Trail East
P.O. Box 21
Shady Grove, Pennsylvania 17256, U.S.A.
Tel: [Int + 1] (717) 597-8121
Fax: [Int + 1] (717) 597-4062
Western Hemisphere, Asia/Pacific

Grove Europe Limited*
Sunderland SR4 6TT, England
Tel: [Int +44] 191 565-6281
Fax: [Int +44] 191 564-0442
Europe, Africa, Middle East

Grove Europe Limited*
P.O. Box No. 268
4A Kimber Road
Abingdon, Oxfordshire, OX141SG
Tel: [Int + 44] 1235 55-3184
Fax: [Int + 44] 1235 55-3218

Deutsche Grove GmbH
Sales and Service
Helmholtzstrasse 12, Postfach 5026
D-40750 Langenfeld, Germany
Tel: [Int + 49] (2173) 8909-0
Fax: [Int + 49] (2173) 8909-30

Wilhelmshaven Works
Industriegelände West, Postfach 1853
D-26358 Wilhelmshaven, Germany
Tel: [Int +49] (4421) 294-0
Fax: [Int +49] (4421) 294-301

Grove France S.A.
16, chaussée Jules-César, 95520 OSNY
B.P. 203, 95523 CERGY PONTOISE CEDEX
France
Tel: [Int + 33] (1) 30313150
Int: [Int + 33] (1) 30386085

*Grove Europe Limited, Registered in England,
Number 1845128, Registered office, Crown Works,
Pallion, Sunderland, Tyne & Wear, England SR4 6TT

Grove Asia/Pacific - Regional Office

171 Chin Swee Road
#06-01 San Centre
Singapore 0316
Tel: [Int +65] 536-6112
Fax: [Int + 65] 536-6119
Asia/Pacific, Near East

Grove China - Representative Office

Beijing Hotel Room 6074
No. 33 East Chang An Avenue
Beijing, 100004, China
Tel: [Int + 86] (10) 513-7766
Fax: [Int + 86] (10) 513-7307

Grove Product Support

Western Hemisphere, Asia/Pacific
1086 Wayne Avenue
Chambersburg, Pennsylvania USA
Tel: [Int +1] (717) 263-5100
Fax: [Int + 1] (717) 267-0404

Europe, Africa, Middle East
Sunderland SR4 6TT, England
Tel: [Int +44] 191 565-6281
Parts Fax: [Int +44] 191 510-9242
Service Fax: [Int + 44] 191 510-9560

Constant improvement and engineering progress make it necessary that we reserve the right to make specification, equipment, and price changes without notice. Illustrations shown may include optional equipment and accessories and may not include all standard equipment.

Distributed By: