

## MDT 489 M25

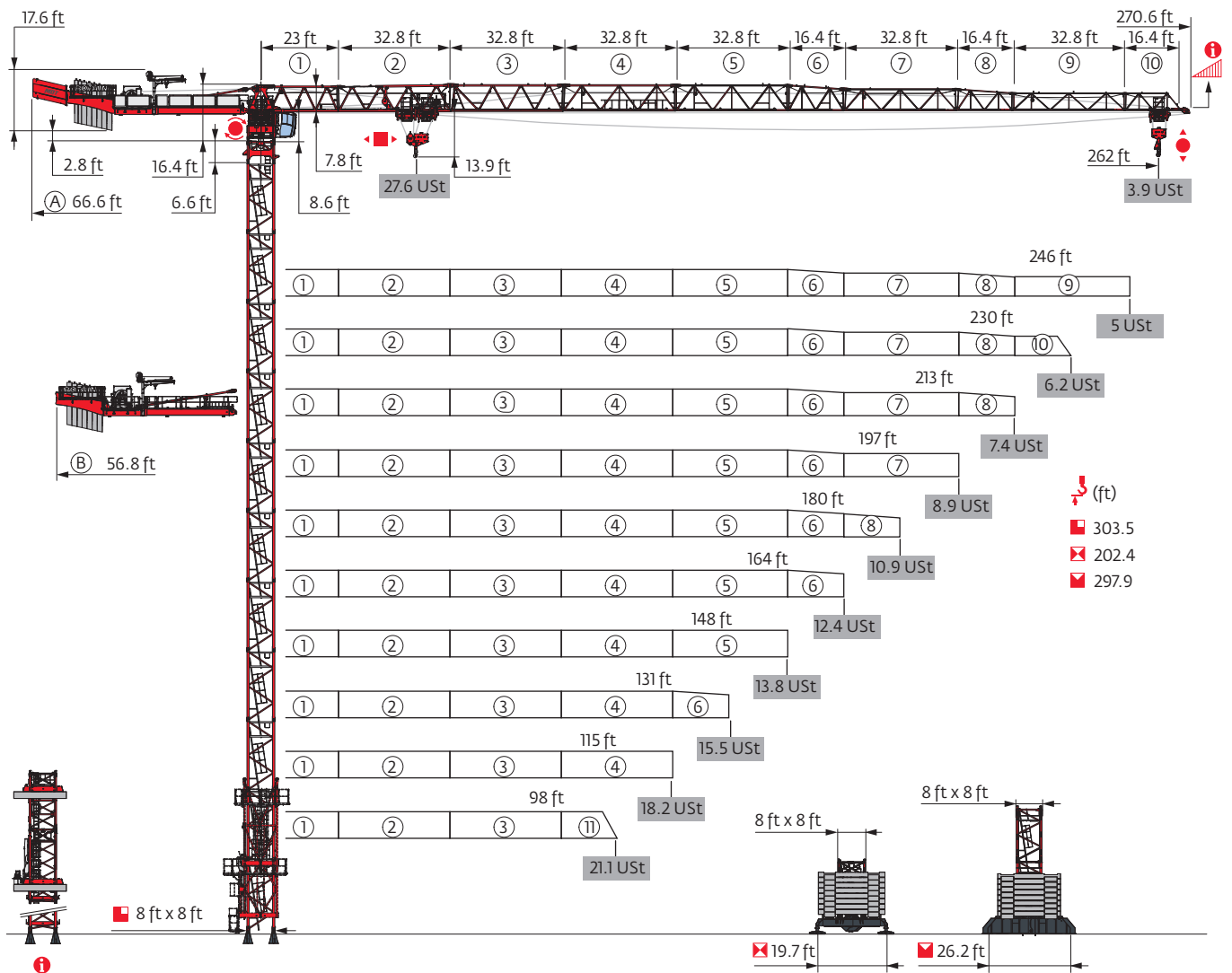

Potain Plus



Power Control

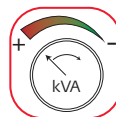

Top Site



Top Tracing 3

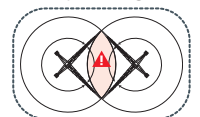

Mast - Reactions

8 ft - P 800B											
Height (ft)	98	115	131	148	164	180	197	213	230	246	262
Height (ft)	243.1	237.9	243.1	237.9	232.3	232.3	232.3	232.3	221.5	221.5	205.1
Height/P (ft)	243.1	237.9	243.1	237.9	232.3	232.3	232.3	232.3	221.5	221.5	205.1
6.6 ft	1	1	1	1	1	1	1	1	1	1	1
10.9 ft	1	2	1	2	0	0	0	0	2	2	2
16.4 ft	14	13	14	13	14	14	14	14	12	12	11
F2 (Ust)	● 271	266	274	272	263	272	272	270	264	261	240
	■ 377	360	380	371	348	352	356	361	346	361	317
F3 (Ust)	● 181	173	178	174	165	171	170	166	161	158	138
	■ 299	280	297	286	263	265	266	270	255	271	229

8 ft - P 854A											
Height (ft)	98	115	131	148	164	180	197	213	230	246	262
Height (ft)	303.5	303.5	303.5	297.9	297.9	297.9	297.9	297.9	292.3	287.1	287.1
Height/P (ft)	303.5	303.5	303.5	297.9	297.9	297.9	297.9	297.9	292.3	287.1	287.1
6.6 ft	1	1	1	1	1	1	1	1	1	1	1
10.9 ft	2	2	2	0	0	0	0	0	1	2	2
16.4 ft	17	17	17	18	18	18	18	18	17	16	16
F2 (Ust)	● 337	335	340	332	331	341	343	344	348	341	344
	■ 613	610	616	584	585	597	600	602	596	593	599
F3 (Ust)	● 229	224	227	219	216	222	223	223	227	223	224
	■ 518	511	516	485	483	491	493	494	489	487	493

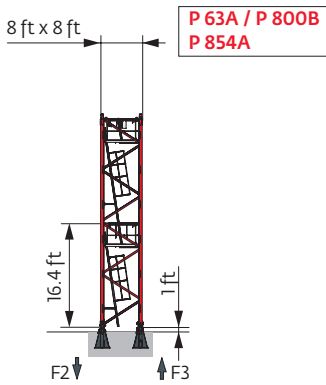

Note: When "ASCE" is noted in this data sheet it is referring to 115 mph Wind Zone, Exposure B, Design Wind Speed = 98 mph. See back cover for design wind speed calculations.

**i** Motorized accesses: adapted mast compositions, base ballast and reactions.

Other mast compositions - Please consult us

8 ft - ZX 6830 - 

Height (ft)	98	115	131	148	164	180	197	213	230	246	262
Height (ft)	191.6	186	186	186	186	197.2	202.4	191.6	191.6	197.2	197.2
Height/P+ (ft)	186	186	186	180.8	186	175.2	186	186	186	186	191.6
6.6 ft	1	1	1	1	1	1	1	1	1	1	1
10.9 ft	2	0	0	0	0	1	0	2	2	1	1
16.4 ft	10	11	11	11	11	11	12	10	10	11	11
FI (Ust)	● 157	155	157	155	155	156	158	154	156	158	157
	■ 145	137	140	139	140	150	156	148	154	171	172

8 ft - ZY 800 - 

Height (ft)	98	115	131	148	164	180	197	213	230	246	262
Height (ft)	242.1	236.9	236.9	236.9	231.3	225.7	225.7	225.7	220.5	214.9	204.1
Height/P+ (ft)	242.1	236.9	231.3	236.9	225.7	225.7	225.7	225.7	220.5	214.9	204.1
6.6 ft	1	1	1	1	1	1	1	1	1	1	1
10.9 ft	2	0	0	0	1	2	2	2	0	1	0
16.4 ft	13	14	14	14	13	12	12	12	13	12	12
FI (Ust)	● 159	153	156	157	152	155	154	153	150	143	141
	■ 187	170	174	176	168	163	165	169	162	166	150

8 ft - ZY 854 - 

Height (ft)	98	115	131	148	164	180	197	213	230	246	262
Height (ft)	297.9	297.9	297.9	292.3	292.3	292.3	292.3	286.8	286.8	281.5	270.3
Height/P+ (ft)	297.9	297.9	297.9	292.3	292.3	292.3	292.3	286.8	286.8	281.5	270.3
6.6 ft	1	1	1	1	1	1	1	1	1	1	1
10.9 ft	1	1	1	2	2	2	2	0	0	1	0
16.4 ft	17	17	17	16	16	16	16	17	17	16	16
FI (Ust)	● 219	217	220	219	217	223	226	215	222	218	206
	■ 306	304	310	302	304	308	311	296	305	305	279

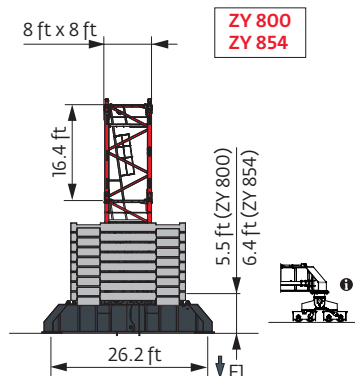
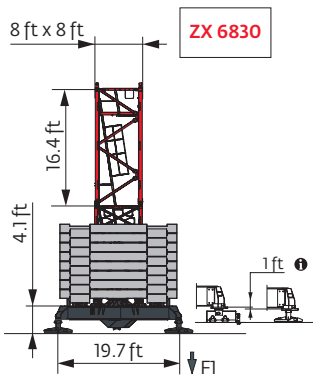

Anchorage



Base ballast

**USt) / 8 ft - ZX 6830 -**

ft)	98	115	131	148	164	180	197	213	230	246	262
202.4							133.4				
197.2						133.4	133.4			144.4	144.4
191.6	155.4					133.4	122.4	122.4	133.4	144.4	144.4
186	166.5	155.4	155.4	144.4	144.4	122.4	133.4	133.4	133.4	144.4	144.4
169.6	155.4	144.4	144.4	144.4	144.4	133.4	122.4	122.4	133.4	133.4	133.4
153.2	144.4	144.4	133.4	133.4	133.4	122.4	111.3	122.4	133.4	133.4	133.4
136.8	133.4	122.4	122.4	122.4	122.4	111.3	100.3	122.4	133.4	122.4	133.4
120.4	122.4	122.4	122.4	122.4	122.4	111.3	89.3	111.3	122.4	122.4	122.4
104	122.4	122.4	111.3	122.4	111.3	111.3	89.3	111.3	122.4	122.4	122.4
87.6	122.4	122.4	111.3	122.4	111.3	111.3	89.3	111.3	122.4	111.3	122.4
71.2	122.4	122.4	111.3	122.4	111.3	100.3	89.3	111.3	122.4	111.3	122.4

**USt) / 8 ft - ZY 800 -**

ft)	98	115	131	148	164	180	197	213	230	246	262
242.1	105.8										
236.9	92.6	92.6	92.6	92.6							
231.3	92.6	92.6	92.6	79.4	66.1						
225.7	92.6	92.6	79.4	79.4	79.4	79.4	66.1	66.1			
220.5	92.6	79.4	79.4	79.4	79.4	66.1	66.1	66.1	66.1		
214.9	79.4	79.4	79.4	79.4	79.4	66.1	66.1	52.9	66.1	66.1	
204.1	79.4	79.4	79.4	66.1	66.1	52.9	52.9	52.9	66.1	66.1	79.4
187.7	79.4	66.1	66.1	66.1	66.1	52.9	39.7	52.9	66.1	66.1	66.1
171.3	66.1	66.1	66.1	52.9	52.9	52.9	39.7	52.9	66.1	66.1	66.1
154.9	66.1	52.9	52.9	52.9	52.9	52.9	39.7	52.9	66.1	66.1	66.1
138.5	52.9	52.9	52.9	39.7	39.7	52.9	39.7	52.9	52.9	66.1	66.1
122.1	52.9	39.7	39.7	39.7	39.7	52.9	39.7	52.9	52.9	52.9	66.1
105.6	52.9	39.7	39.7	39.7	39.7	52.9	39.7	52.9	52.9	52.9	52.9
89.2	52.9	39.7	39.7	39.7	39.7	52.9	39.7	52.9	52.9	52.9	52.9
72.8	52.9	39.7	39.7	39.7	39.7	52.9	39.7	52.9	52.9	52.9	52.9

**USt) / 8 ft - ZY 854 -**

ft)	98	115	131	148	164	180	197	213	230	246	262
297.9	238.1	224.9	224.9								
292.3	224.9	211.6	211.6	224.9	211.6	211.6	224.9				
286.8	198.4	185.2	198.4	198.4	198.4	198.4	198.4	198.4	211.6		
281.5	185.2	185.2	185.2	185.2	185.2	185.2	185.2	185.2	198.4	211.6	
270.3	158.7	145.5	145.5	145.5	145.5	145.5	145.5	145.5	158.7	185.2	185.2
253.9	119.1	119.1	119.1	119.1	105.8	105.8	105.8	105.8	119.1	132.3	132.3
237.5	92.6	79.4	79.4	79.4	79.4	79.4	66.1	66.1	79.4	92.6	105.8
221.1	79.4	79.4	79.4	66.1	66.1	66.1	52.9	52.9	52.9	66.1	79.4
204.7	66.1	66.1	66.1	66.1	66.1	52.9	39.7	39.7	52.9	66.1	66.1
188.3	66.1	66.1	52.9	52.9	52.9	39.7	39.7	39.7	52.9	66.1	66.1
171.9	52.9	52.9	52.9	52.9	52.9	39.7	26.5	39.7	52.9	52.9	52.9
155.5	52.9	39.7	39.7	39.7	39.7	39.7	26.5	39.7	52.9	52.9	52.9
139.1	39.7	39.7	39.7	39.7	26.5	39.7	26.5	39.7	52.9	52.9	52.9
122.7	39.7	39.7	39.7	39.7	26.5	39.7	26.5	39.7	52.9	52.9	52.9
106.3	39.7	39.7	39.7	39.7	26.5	39.7	26.5	39.7	52.9	39.7	52.9
89.9	39.7	39.7	39.7	39.7	26.5	39.7	26.5	39.7	52.9	39.7	39.7
73.5	39.7	39.7	39.7	39.7	26.5	39.7	26.5	39.7	52.9	39.7	39.7

Counter-jib ballast

ft)	132 HPL™			180 HPL™ GH		
	14,551 lb	10,362 lb	(lb)	14,551 lb	10,362 lb	(lb)
262 ft	6	2	108,027	7	0	101,854
246 ft	7	0	101,854	6	1	97,665
230 ft	7	0	101,854	6	1	97,665
213 ft	7	0	101,854	6	1	97,665
197 ft	6	1	97,665	5	2	93,476
180 ft	5	2	93,476	6	0	87,303
164 ft	6	0	87,303	5	1	83,114
148 ft	4	2	78,925	3	3	74,737
131 ft	5	0	72,753	4	1	68,564
115 ft	4	1	68,564	3	2	64,375
98 ft	4	0	58,202	3	1	54,013

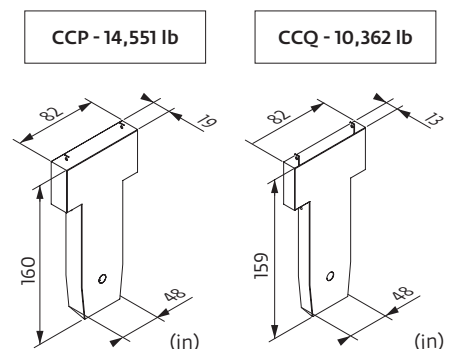

Load curves



		(ft)																				ft			
		27.6 USt										13.8 USt													
		56	66	82	98	115	131	138	148	154	164	171	180	187	197	203	213	220	230	236	246	253	262		
262	13.1 → 46.9 13.1 → 50.5	22.4 18.5 14	12.5 10.5 8.9 8.4 7.7 7.3 6.7 6.4 6 5.7 5.3 5.1 4.8 4.6 4.3 4.1 3.9 3.7 3.5	USt																					USt
246	13.1 → 55.1 13.1 → 59.4	24.7 20.3 15.4	13.8 11.5 9.8 9.2 8.5 8 7.4 7.1 6.6 6.3 5.8 5.6 5.2 5 4.7 4.5 4.3 4.1 3.9	USt																					USt P+
230	13.1 → 65.6 13.1 → 68.9	27.1 22.3 16.9	13.8 12.2 10.4 9.8 9 8.5 7.8 7.5 6.9 6.6 6.2 5.9 5.5 5.3 5 4.8 4.5	USt																					USt P+
213	13.1 → 69.6 13.1 → 71.5	27.6 27.6 20.7 16.2	13.8 12.2 11.5 10.5 9.9 9.1 8.7 8 7.7 7.1 6.8 6.4 6.1 5.7	USt																					USt P+
197	13.1 → 70.2 13.1 → 74.1	27.6 27.6 22.8 18.2 14.9	13.8 13.1 12 11.4 10.5 10 9.4 8.9 8.4	USt																					USt P+
180	13.1 → 71.9 13.1 → 75.8	27.6 27.6 23.8 19.3 16.1	13.8 13.8 13.2 12.5 11.7 11.2 10.5	USt																					USt P+
164	13.1 → 73.2 13.1 → 73.2	27.6 27.6 24.2 19.6 16.4 14	13.8 13.4 12.8 11.9 11.3 10.4 9.9 9.2 8.8 8.2 7.9 7.4	USt																					USt P+
148	13.1 → 73.8 13.1 → 73.8	27.6 27.6 24.5 19.9 16.6 14.1	13.8 13.6	USt																					USt P+
131	13.1 → 74.8 13.1 → 74.8	27.6 27.6 24.8 20.1 16.8 14.3	13.8 13.8	USt																					USt P+
115	13.1 → 75.1 13.1 → 75.1	27.6 27.6 25.2 20.8 17.6	13.8 13.8	USt																					USt P+
98	13.1 → 73.8 13.1 → 74.1	27.6 27.6 24.4 19.8	13.8 13.8	USt																					USt P+

$\text{USt} = \text{USt} - 1.58 \text{ USt max.}$













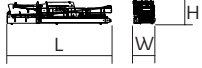



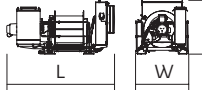

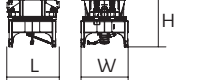
		(ft)																				ft				
		27.6 USt										13.8 USt														
		56	66	82	98	115	131	138	148	154	164	171	180	187	197	203	213	220	230	236	246	253	262			
262	10.8 → 47.6 10.8 → 51.5	22.9 19 14.5	11.9 9.8 8.3 7.8 7.1 6.7 6.1 5.8 5.3 5.1 4.7 4.5 4.1 3.9 3.7 3.5 3.3 3.1 2.9	USt																						USt
246	10.8 → 55.8 10.8 → 60.4	25.2 20.8 15.9	13.2 10.9 9.2 8.6 7.9 7.4 6.8 6.4 5.9 5.6 5.2 5 4.6 4.4 4.1 3.9 3.7 3.5 3.3	USt																						USt P+
230	10.8 → 66.9 10.8 → 70.2	27.6 22.8 17.4 13.8	11.7 9.8 9.2 8.4 7.9 7.3 6.9 6.4 6.1 5.6 5.3 5 4.7 4.4 4.2 4	USt																						USt P+
213	10.8 → 71.2 10.8 → 73.2	27.6 27.6 21.2 16.8	13.8 11.8 11 10 9.5 8.7 8.2 7.6 7.2 6.7 6.4 5.9 5.7 5.3	USt																						USt P+
197	10.8 → 71.2 10.8 → 75.5	27.6 27.6 23 18.2 14.9	12.8 12 11 10.3 9.5 9 8.3 7.9 7.4 7 6.5	USt																						USt P+
180	10.8 → 73.5 10.8 → 77.4	27.6 27.6 24.9 20 16.6 14	13.4 12.7 11.6 11 10.2 9.6 9 8.5 8	USt																						USt P+
164	10.8 → 74.5 10.8 → 74.5	27.6 27.6 24.4 19.9 16.7 14.3	13.8 12.8 12.1 11.3 10.8 10.1	USt																						USt P+
148	10.8 → 75.5 10.8 → 75.5	27.6 27.6 25.8 21 17.5 15 14.1	13.3 12.7 11.8 11.2 10.5	USt																						USt P+
131	10.8 → 76.1 10.8 → 76.1	27.6 27.6 24.8 20.3 17 14.6	13.8 13 12.4 11.5	USt																						USt P+
115	10.8 → 76.8 10.8 → 76.8	27.6 27.6 24.9 20.5 17.4 15 14.2	13.4 12.8 12	USt																						USt P+
98	10.8 → 75.1 10.8 → 75.5	27.6 27.6 25.1 20.5	13.8 13.8	USt																						USt P+

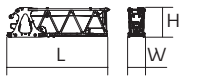
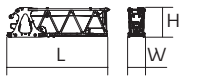

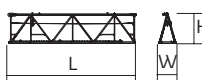



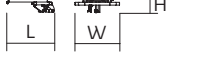



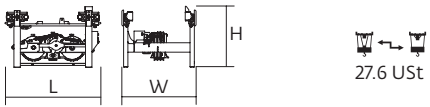

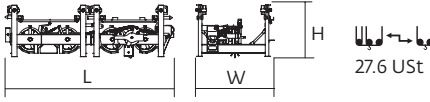
$\text{USt} = \text{USt} - 0.71 \text{ USt max.}$

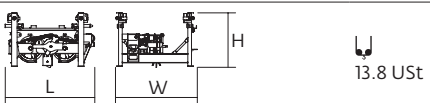
Dimensions and weight

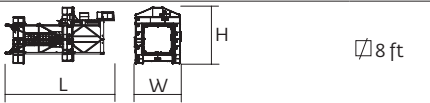
Slewing crane part:  262 ft -  132 HPL™

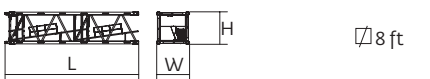

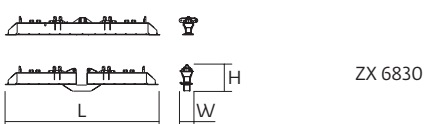
Slewing crane part		L (ft)	W (ft)	H (ft)	lb (+/- 5%)
Counter-jib	 (A) (B)	39	7.2	8.3	29,983
	 (A) (B) 132 HPL™	62.9	18.7	12.9	33,290
	 (A) (B) 132 HPL™	53	18.7	12.9	32,408
	 (A) (B) 180 HPL™ GH	62.9	22	12.9	44,677
	 (B)	53	22	12.9	43,795
Hoisting winch (+ rope)	 132 HPL™ 180 HPL™ GH	12.4 15.8	6.1 6.3	6.2 6.5	11,387 19,282
Cab	 Ultra View	11	7.5	8.2	6,614
Towerhead	 2,45 m	9.1	8.1	9.5	24,912
	 2,45 m	23.1	8.1	9.5	31,526
	 2,45 m				
Jib section	 ①	27.8	5.2	8.1	14,771
	 ②	34	7.3	8.2	14,330
	 ③	34	4.5	8.2	7,937
	 ④	33.7	4.5	8	6,790
	 ⑤	33.6	4.5	8	4,960
	 ⑦	33.7	4.5	6.7	3,329
	 ⑧	33.4	4.5	5.7	2,293
	 ⑥	17.4	4.5	7.8	2,425
	 ⑧	17.1	4.5	6.5	1,455
	⑩	16.7	4.5	5.3	992
	⑪	17	4.5	8	3,660
	⑪	5.5	5.2	1.9	575

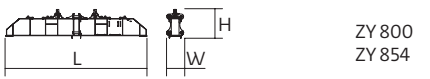
		L (ft)	W (ft)	H (ft)	lb (+/- 5%)
Trolley		7.3	5.7	4.7	1,676
Pulley block		5.1	1.9	8	1,874
Trolley		12.5	5.6	4.1	2,469
Pulley block		6.3	1.1	7.7	2,028
Trolley		6.6	5.6	4.1	1,323
Pulley block		4.1	1.1	8.5	1,345
Trolley inspection platform		3.1	3.4	7	125
<b>Crane tower</b>					
T 851		36.7	15.9	19	34,723
K 84/K 84-2		7.3	10.6	8.2	6,724
KRM 849B K 85/KR 84B2 KM 850.10B KM 850.14B K 85/KR 84A2 KMT 850.10A KMT 850.14A K 849A KMT 849A KR 849A KRMT 849A KRMT 849C KMT 850.10C		33.6 33.6 33.9 33.9 17.2 17.5 17.5 17.2 17.2 17.2 17.2 11.7 12	8.4 8.3 8.3 8.3 8.3 8.3 8.3 8.3 8.4 8.3 8.4 8.4 8.3	8.3 8.2 8.2 8.2 8.2 8.2 8.2 8.2 8.3 8.3 8.3 8.3 8.2	17,196 21,242 22,201 24,670 12,236 12,015 13,206 7,496 6,945 9,458 9,017 7,066 9,326
Fixing angles		2.5 3	2.5 3	4.2 4.9	1,025 2,072
Cross girder		29.9 29.9	3.7 2.5	3.6 4.9	11,607 12,004
1/2 Cross girder		18.6 18.7	3.2 3.2	6.3 7.4	10,406 14,176
Cross girder		39.2 39	4.6 4.7	6.3 7.4	22,212 30,865

Mechanisms

480 V - 60 Hz													hp	kW	
	<b>132 HPL™ 63</b>	fpm	133	172	243	363	502	67	87	125	185	251	132	98	2,815 ft
		USt	13.8	10.4	6.9	3.4	1.1	27.6	20.7	13.8	6.9	2.9			
	<b>180 HPL™ 63 GH</b>	fpm	179	220	289	438	640	90	112	149	238	320	180	132	3,937 ft
		USt	13.8	10.4	6.9	3.4	0.9	27.6	20.7	13.8	6.9	3.3			
	<b>10 DVF 10 Optima</b>	fpm	0 → 217 (27.6 USt) 0 → 262 (22 USt) 0 → 328 (13.8 USt) 0 → 361 (6.9 USt)					10	7.4						
	<b>RVF 173 Optima +</b>	rpm	0 → 0.7									3 x 10	3 x 7.5		

	<b>IEC 60204-32</b>	<b>kVA</b>
480 V (+6% -10%) 60 Hz	132 HPL™: 142 → 90 kVA 180 HPL™ GH: 181 → 109 kVA	

These mast combinations meet the EN 14439 and ASME B30.3-2016 specifications for "out of service" wind conditions, provided the illustrated wind speed matches required design wind speed for the location of the tower crane. The "out of service" design wind speed was determined in accordance with ASCE 7-10, Figure 26.5-1A. The wind velocity, used for this configuration was 98 mph (158 kph), which represents a nominal design 3-second wind gust at 33 ft (10 m) above ground for Exposure B category. A factor of 0.85 was applied to the 700-year ultimate design wind speed of 115 mph (185 kph), per ASCE 37-02, with the assumption that this crane is considered a temporary structure used during a construction period of 2 years or less.

- Jib elevation
- Standard equipment
- Options
- Potain Plus function: Plus load curves
- Hook heights with Plus load curves
- Reactions in service
- Reactions out of service
- Total ballast weight
- Jib weight
- Lorry 44 ft
- Container High Cube 40 ft, and/or Flat Rack 20 ft
- Hoisting
- Trolleying
- Slewing
- Travelling
- Required power
- Power Control Function: winch speeds adapted to the available power
- Consult us

This commercial document is not legally binding. For any technical information, please refer to the corresponding instructions.

