

Potain MR 615

Product Guide



Features

- Luffing jib with maximum radius of 60 m (197 ft)
- 32 t (35.3 USt) maximum capacity
- 8,25 t (9.1 USt) maximum capacity at 60 m (197 ft)
- Internal and external climbing with K mast
- 240 m/min (787 fpm) maximum single-part line speed

Features



245 LBR 160 hoist

The 245 LBR 160 hoist provides one (1)-part line speeds from 5,7 m/min – 240 m/min (19 fpm – 787 fpm) with loads of 16 t – 2 t (17.6 USt – 2.2 USt) respectively. This 245 hp hoist has a maximum drum capacity of 670 m (2198 ft) and allows for optimized productivity in two (2)-part line configuration as well.



Multiple jib lengths

The MR 615 comes standard with a 30 m (98 ft) jib which can be increased in 10 m (33 ft) increments to a maximum jib length of 60 m (197 ft) jib. Able to be luffed from 15° – 85°, the MR 615 can easily maneuver on a restrictive jobsite.

K mast

Potain's K mast offers many benefits to your jobsite. Its stepped pins provide easy installation and instant visual inspection decreasing tower assembly time. This mast is available in multiple lengths to allow you to customize the crane to your needs.



Vision cab V140SR

Vision cab V140SR is equipped with all of the standard features of the V140S with the addition of a guarded glass window on the ceiling for excellent visibility with a luffing jib tower crane.

Contents

Specifications	4
Component weights	6
Dimensions	7
Load charts and mast	8
Luffing jib chart and mechanisms	9
Metric dimensions	10
Metric load charts and mast	11
Metric luffing jib chart and mechanisms	12
Symbols glossary	13

Specifications



Jib

30 m (98 ft) radius lattice jib standard. Catwalks are installed in all sections for maintenance and easy access to sling points. Identification plates are welded on each section. The jib foot attaches to the pivot point and locks in place with two (2) pins. Inspection platform is fixed to the jib nose and equipped with plates on each side for advertising decals.



*Jib extensions

Three (3) optional 10 m (33 ft) jib sections are available for radii of 40 m (131 ft), 50 m (164 ft) and 60 m (197 ft).



Counter-jib

One 10,3 m (33.8 ft) design for all jib configurations. It easily attaches to the turntable with a pin. Hoisting and luffing winches are modular to allow for easy erection. Galvanized catwalks allow access to required areas of the counterjib.



*Counter-jib ballast

Ballast blocks are a steel design. Blocks weighing 6000 kg (13,228 lb) are easily erected and secured in quantities according to corresponding jib lengths.



Cab

140 SR Vision cab is standard and includes heating, window vent, tinted glass, windshield wipers, sun visor, document case, electric socket, side pocket, bottle holder, ergonomic seat with high back, adjustable armrests, height and seating with control units, front-to-back shifting and reclining back.



Controls

Dual axis joystick controls integrated into cab seat standard.



Reeving

SM hookblock for 1-part or 2-part line application standard.

**Denotes optional equipment*



Electrical requirement

480 volt, 60 Hz measured at the turntable.



Dialog Visu and *anemometer

Dialog Visu is standard and displays information to the operator such as height under hook, radius, loads and overload moment, and wind speed (when *anemometer is ordered). Other anemometer options: wind speed alarm, indicator for ground, and recorder.



Swing

RVF 183 Optima + slewing mechanism with maximum swing speed of 1 rpm. Progressive control of speed with counter-slewing possible, anti-load swinging system makes aligning the load and jib easier.



Hoist

245 LBR 160: 245 hp hoist with 670 m (2198 ft) drum capacity is standard with 60 Hz machine. Line speeds range from 2,85 m/min – 120 m/min (9 fpm – 394 fpm) with two (2)-parts of line and 5,7 m/min – 240 m/min (19 fpm – 787 fpm) for one (1)-part of line. Specification of quantity of hoist rope is dependent upon customer's requirements and mast height.



Luffer

215 VBR: 215 hp variable frequency hoist with a luffing time of one (1) minute thirty (30) seconds from 15° to 85°.

*Optional equipment

- STANDARD NORTH AMERICAN SPECIFICATION MR615: includes 60 m (197 ft) jib, electric slip ring, 60 m of cable 2 x (4G50 mm2), counterweight ballast 65 t (68.3 US t), 320 m (1050 ft) cable D34, anemometer for Dialog Visu, and tropicalization
- Electric slip ring
- Jib radius 40 m – 60 m (131 ft – 197 ft)
- Top Tracing
- Anemometer

**Consult price list for additional options*

Specifications



*Mast

K mast in size of K800 2,45 m (8.0 ft), panel or monoblock, and climbing or non-climbing available. Lengths of 3,33 m (10.9 ft), 5 m (16.4 ft), and 10 m (32.8 ft) available. Identification plates welded on each section to designate the type of mast and pin box to stow pins when not in use.

This patented pin connected mast is well known for its robustness, ease of erection and low maintenance connection.

Mast nomenclature:

K – Series of mast with box angled members

M – Monoblock, non climbing

R – Reinforced

MT – Monoblock & climbing

RMT – Reinforced, monoblock, climbing

Equipped with aluminum ladders and galvanized steel resting platforms in each section. Cast connections are secured with two double tapered pins.

*Tirax tool and *Tirax pins available for faster easier assembly.

Other combinations of masts can allow free-standing HUH to increase. Consult us for details.



*Climbing equipment

Equipment available for both internal climbing and external climbing of 2,45 m (8.0 ft) mast. Climbing equipment sold separately: hydraulic unit, jack, and collars. External climbing equipment sold separately: climbing cage, hydraulic unit, yoke, and jack.



*Anchor stools

Anchor stools to be used in combination with a concrete foundation or steel structure.

Anchors P800A: permanent anchor, maximum free-standing HUH: 57,3 m (188.0 ft) for 2,45 m (8.0 ft) K mast, 60 m (197.0 ft) jib.



*Chassis















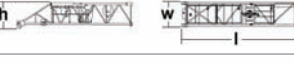
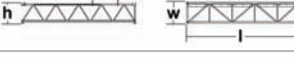
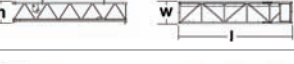

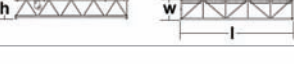
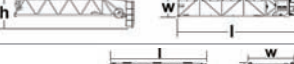
Chassis available with square footprint of 8 m (19.7 ft) or 10 m (32.8 ft) for K800 mast. Chassis are available in either a static mounted configuration or in a traveling configuration with the use of bogies.

Chassis Y800A: square footprint of 8 m (26.2 ft), maximum free-standing HUH: 58,1 m (190.6 ft) for 2,45 m (8.0 ft) K mast, 60 m (197.0 ft) jib.

Chassis J850A: square footprint of 10 m (32.8 ft), maximum free-standing HUH: 72,7 m (238.5 ft) for 2,45 m (8.0 ft) K mast, 60 m (197.0 ft) jib.

**Consult price list for additional options*

Component weights

Component Weights							
Item	Qty.		l m (ft)	w m (ft)	h m (ft)	weight kg (lb)	
1	1	Towerhead 2,45 m (8 ft)		2,75 (9.0)	5,13 (16.8)	4,63 (15.2)	13 780 (30,379)
2	1	Cab V140SR and support		4,62 (15.2)	1,69 (5.5)	2,99 (9.8)	1400 (3086)
3	1	Counter-jib		6,8 (22.3)	4,5 (14.8)	2,5 (8.2)	18 300 (40,344)
4	1	Hoisting winch		3,75 (12.3)	4,18 (13.7)	2,03 (6.7)	13 550 (29,872)
5	1	Strut + chain block support + pulley block		2,15 (7.1)	2,68 (8.8)	13,9 (45.6)	11 675 (25,739)
6	1	Jib foot		9,6 (31.5)	1,9 (6.2)	1,83 (6)	3810 (8399)
7	1	Jib section		10,35 (34)	1,9 (6.2)	1,83 (6)	1965 (4332)
8	1	Jib section		10,35 (34)	1,9 (6.2)	1,83 (6)	2045 (6709)
9	1	Jib section		10,35 (34)	1,9 (6.2)	1,83 (6)	1755 (3869)
10	1	Jib section		10,35 (34)	1,9 (6.2)	1,83 (6)	1515 (3340)
11	1	Jib section + inspection platform		11,35 (37.2)	1,9 (6.2)	2,88 (9.4)	3360 (7407)
12	X	KR839A2		5,2 (17.2)	2,5 (8.1)	2,5 (8.3)	4175 (9204)
13	X	KR839C2		3,6 (11.8)	2,5 (8.1)	2,5 (8.3)	3065 (6757)
14	X	KMT 850.10C1		3,7 (12)	2,5 (8.3)	2,5 (8.2)	4230 (9325)
15	X	KMT850.10A1		5,3 (17.5)	2,5 (8.3)	2,5 (8.2)	5450 (12,015)
16	X	KM850-10B1		10,3 (33.8)	2,5 (8.1)	2,5 (8.3)	10 070 (22,200)
17	X	K850/KR800B1		10,2 (33.6)	2,5 (8.3)	2,5 (8.3)	9730 (21,451)
18	1	Rear half of equipped T850A climbing cage		10,2 (33.3)	4,7 (15.3)	3,3 (10.8)	9230 (20,348)
19	1	Front half of equipped T850A climbing cage		10,1 (33)	4,7 (15.4)	2,6 (8.4)	3690 (8135)
20	4	Fixing angle P800US		0,8 (2.5)	0,8 (2.5)	1,8 (5.9)	670 (1477)

NOTE: The information above is useful as a basic introduction to the crane.

In no case may this serve as a substitute for the serial numbered manuals. Dimensions have been rounded to the nearest tenth.

Dimensions

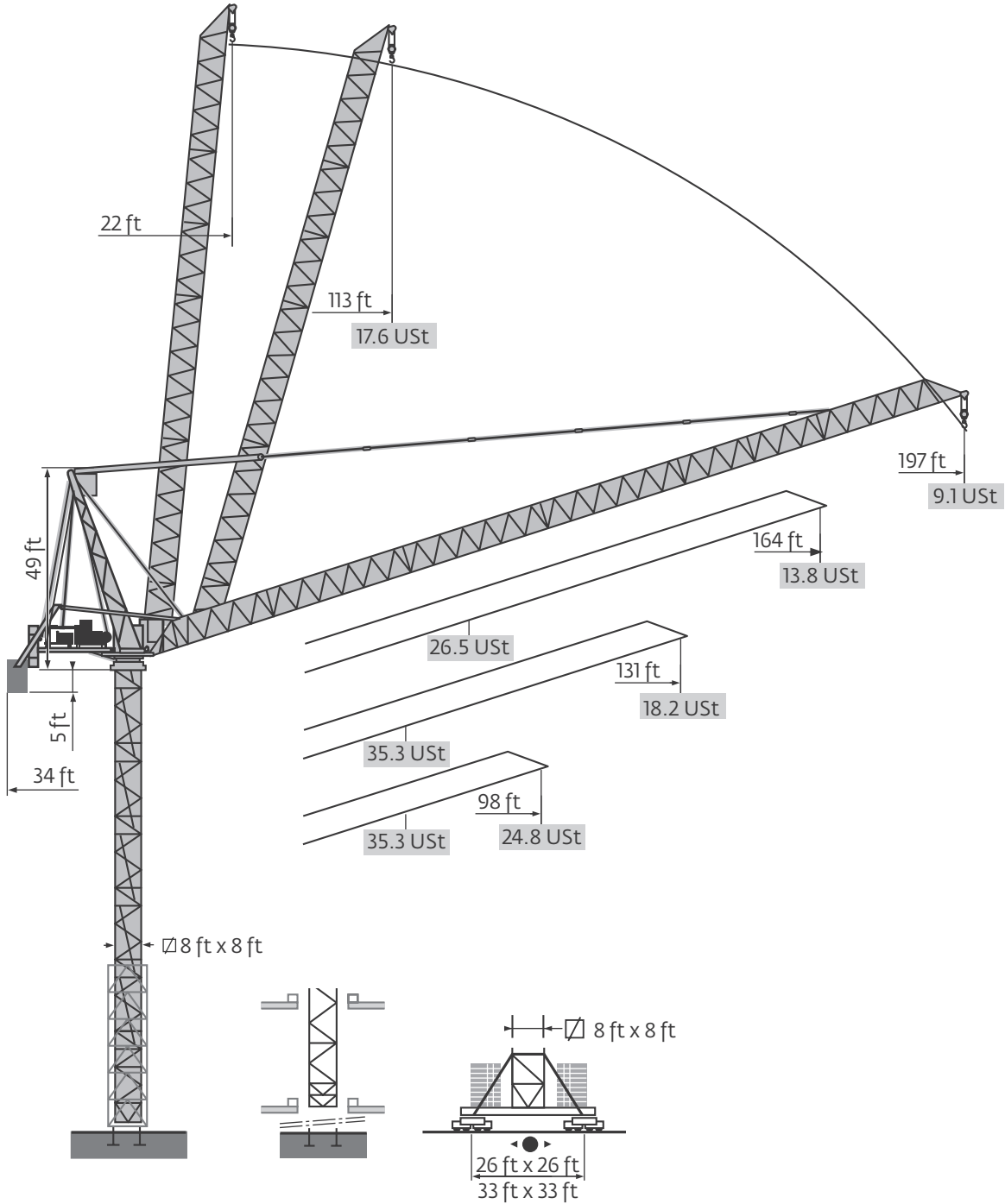

Load charts and mast

197 ft	22								113	115	121	131	138	148	154	164	171	180	187	197	ft
		17.6 17.3 16.3 14.9 14.0 12.9 12.2 11.4 10.9 10.1 19.4 9.1 USt																			
164 ft	19																				ft
		26.5 24.7 22.9 20.6 19.4 17.6 16.6 15.3 14.6 13.5 USt																			
		17.6 16.9 15.5 14.8 13.2 USt																			
131 ft	16																				ft
		35.3 31 28.4 25.4 23.6 21.3 20 18.2 USt																			
		17.6 USt																			
98 ft	11																				ft
		35.3 34.9 30.4 27.9 24.8 USt																			
		17.6 USt																			

K800 Mast

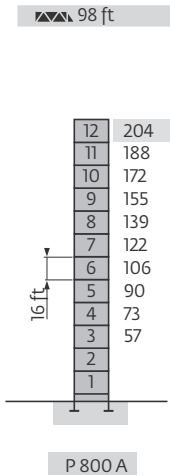

	H (ft)	16 ft	11 ft
131 ft	194	10	2
164 ft - 197 ft	188	11	-

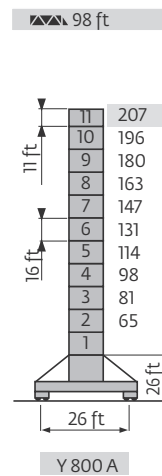



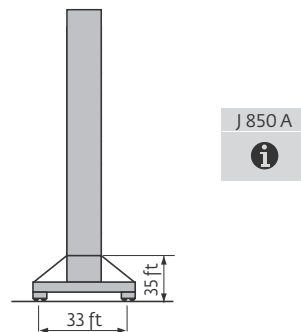
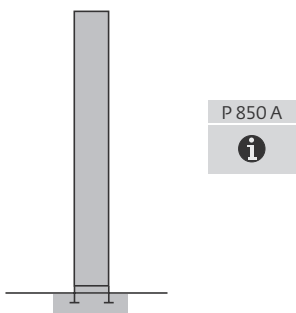
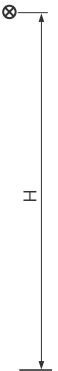





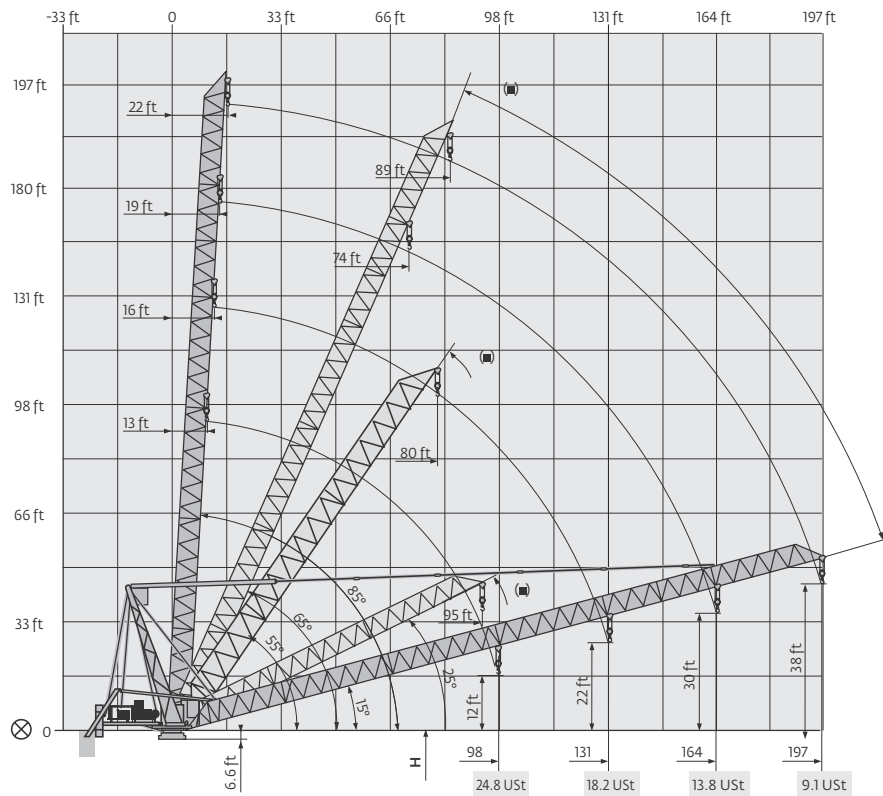

	H (ft)	16 ft	11 ft
131 ft	191	9	1
164 ft	185	8	2
197 ft	191	9	1



NOTE: Illustrated hook heights on this page were determined using FEM 1.001. Configurations shown may include optional equipment. Other codes may require reduction in configurations.

Luffing jib chart and mechanisms



MR 615 H32 60 Hz											hp	kW	
	245 LBR 160	fpm	19/187	30/302	47/472	79/787	9.4/94	15/151	24/236	39/394	245	180	2198 ft
		USt	17.6	9.9	5.5	2.2	35.3	19.8	11	4.4			
	215 VBR		1 min 30 s								215	158	
	RVF183 Optima +	rpm	0 → 1								3 x 12	3 x 9	
	RT 584 A1 - 2V	fpm	52 - 105								8 x 8.4	8 x 6.2	
	J 850 A	fpm											
CEI 38 			IEC 38				kVA						
480 V (+6% -10%) 60 Hz						245 LBR 160 : 445 kVA							

THIS CHART IS ONLY A GUIDE AND SHOULD NOT BE USED TO OPERATE THE CRANE.

Metric dimensions

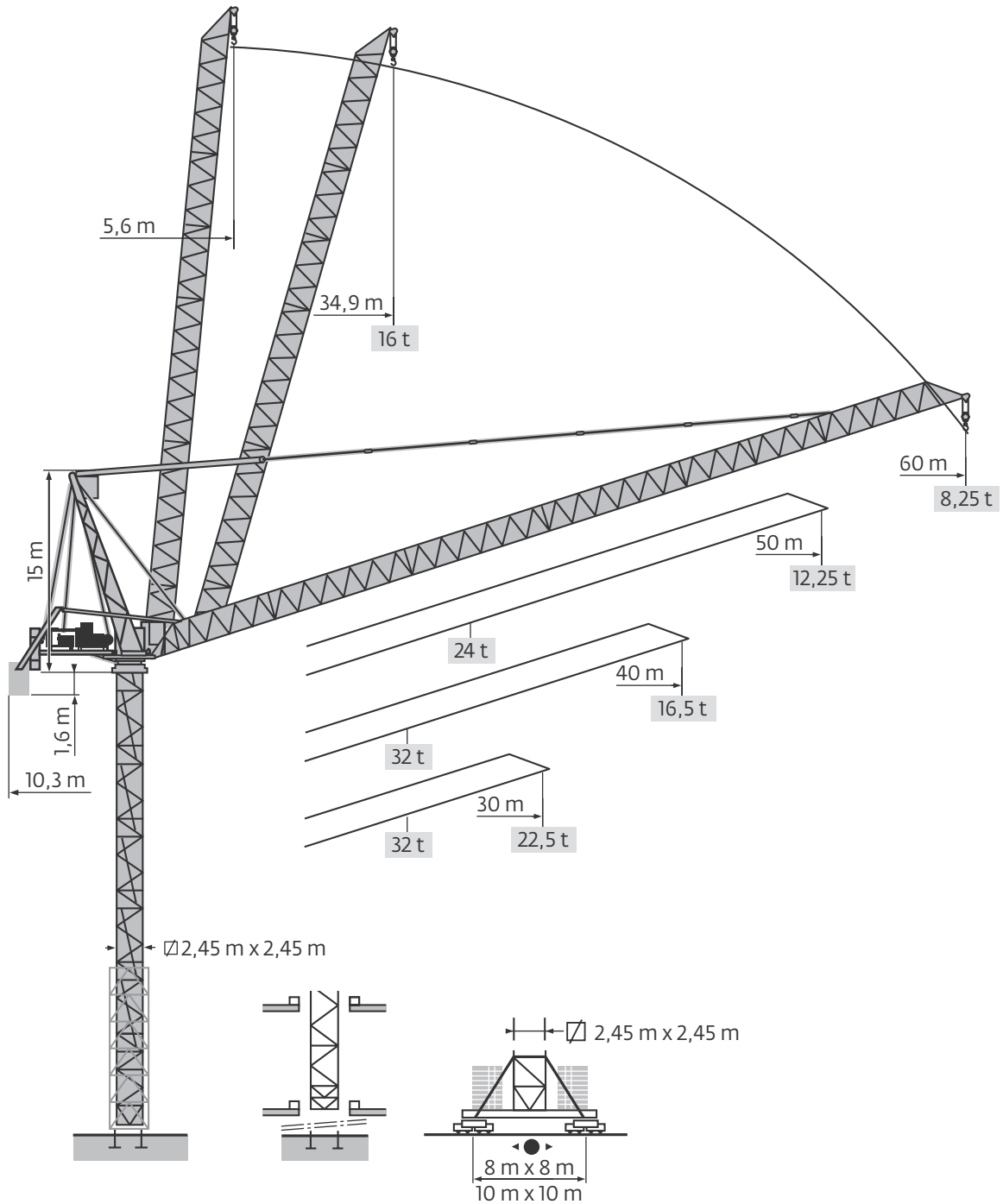

THIS CHART IS ONLY A GUIDE AND SHOULD NOT BE USED TO OPERATE THE CRANE.

The individual crane's load chart, operating instructions and other instructional plates must be read and understood prior to operating the crane.

Metric load charts and mast

60 m	5,6					34,9	35	37	40	42	45	47	50	52	55	57	60	m					
		16																t					
50 m	4,9		28,4	30	32	35	37	40	42	45	47	50	m										
		24												22,5	20,9	18,9	17,7	16,1	15,2	14	13,2	12,25	t
		16																15,5	14,25	13,45	12	t	
40 m	4,2		22,4	25	27	30	32	35	37	40	m												
		32			28,3	26	23,1	21,4	19,3	18,1	16,5	t											
		16																t					
30 m	3,4		21,9	22	25	27	30	m															
		32		31,8	27,6	25,4	22,5	t															
		16																t					

K800 Mast

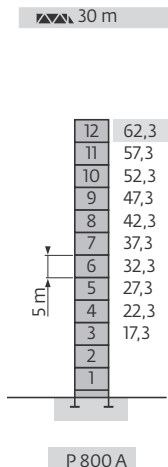

	H (m)	5 m	3.33 m
40 m	59	10	2
50 m - 60 m	57,3	11	—

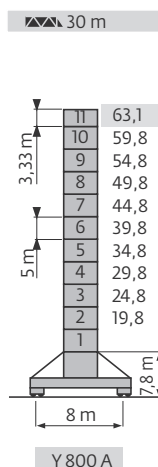



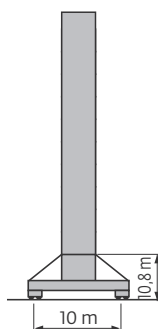
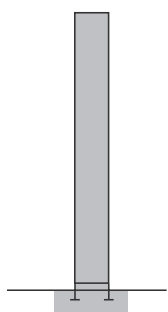
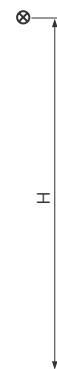



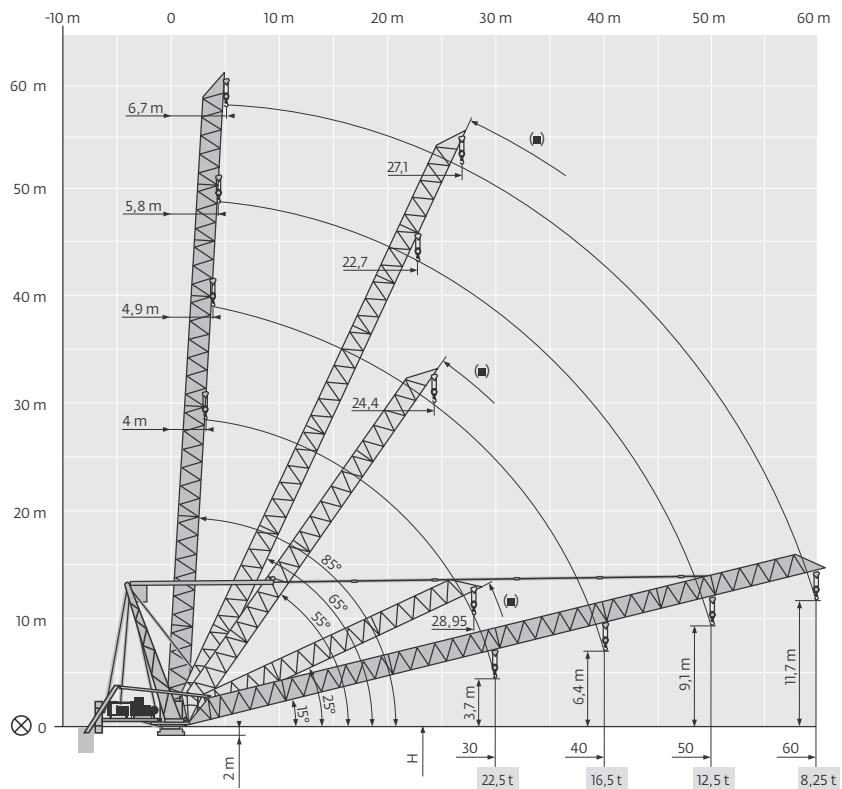



	H (m)	5 m	3.33 m
40 m	58,1	9	1
50 m	56,4	8	2
60 m	58,1	9	1



Metric luffing jib chart and mechanisms



























MR 615 B H32 60 Hz										hp	kW				
	245 LBR 160	m/min	5,7/57	9,2/92	14,4/144	24/240	2,85/28,5	4,6/46	7,2/72	12/120	245	180	670 m		
		t	16	9	5	2	32	18	10	4					
	215 VBR		1 min 30 s									215	158		
	RVF183 Optima +	rpm	0 → 1									3 x 12	3 x 9		
	RT 584 A1-2V	m/min	16 - 32									8 x 8,4	8 x 6,2		
	J 850 A	m/min													
CEI 38 		IEC 38		kVA											
480 V (+6% -10%) 60 Hz		245 LBR 160 : 445 kVA													

THIS CHART IS ONLY A GUIDE AND SHOULD NOT BE USED TO OPERATE THE CRANE.

The individual crane's load chart, operating instructions and other instructional plates must be read and understood prior to operating the crane.

Symbols glossary

 Anchor stools	 Counter jib	 jib	 Traveling
 Anemometer	 Cross-shaped base	 jib extension	 Traversing trolley
 Ballast	 Curve track traveling equipment	 Mast	 Traversing trolley and load diagrams
 Cab	 Electrical requirement	 Reeving 2-part	 Trolley
 Chassis	 Hoist	 Reeving 4-part	
 Climbing equipment	 Hoisting mechanism	 Straight track traveling equipment	
 Controls	 Hydraulic equipment	 Swing	

Notes

Regional headquarters

Manitowoc - Americas

Manitowoc, Wisconsin, USA

Tel: +1 920 684 6621

Fax: +1 920 683 6278

Shady Grove, Pennsylvania, USA

Tel: +1 717 597 8121

Fax: +1 717 597 4062

Manitowoc - Europe, Middle East & Africa

Ecully, France

Tel: +33 (0)4 72 18 20 20

Fax: +33 (0)4 72 18 20 00

Manitowoc - Asia Pacific

Shanghai, China

Tel: +86 21 6457 0066

Fax: +86 21 6457 4955

Regional offices

Americas

Brazil

Alphaville

Mexico

Monterrey

Chile

Santiago

Europe, Middle East & Africa

Algeria

Hydra

Czech Republic

Netvorice

France

Baudemont

Cergy

Decines

Germany

Langenfeld

Hungary

Budapest

Italy

Parabiago

Netherlands

Breda

Poland

Warsaw

Portugal

Baltar

Lisbon

Russia

Moscow

U.A.E.

Dubai

U.K.

Buckingham

Asia - Pacific

Australia

Brisbane

Melbourne

Sydney

China

Beijing

Singapore

Xi'an

Korea

Seoul

India

Hyderabad

Pune

Philippines

Makati City

Factories

Brazil

Alphaville

China

TaiAn

Zhangjiagang

France

Charlieu

La Clayette

Moulins

Germany

Wilhelmshaven

India

Pune

Italy

Niella Tanaro

Portugal

Baltar

Fânzeres

Slovakia

Saris

USA

Manitowoc

Port Washington

Shady Grove

This document is non-contractual. Constant improvement and engineering progress make it necessary that we reserve the right to make specification, equipment, and price changes without notice. Illustrations shown may include optional equipment and accessories and may not include all standard equipment.