

## MDT 349 L16

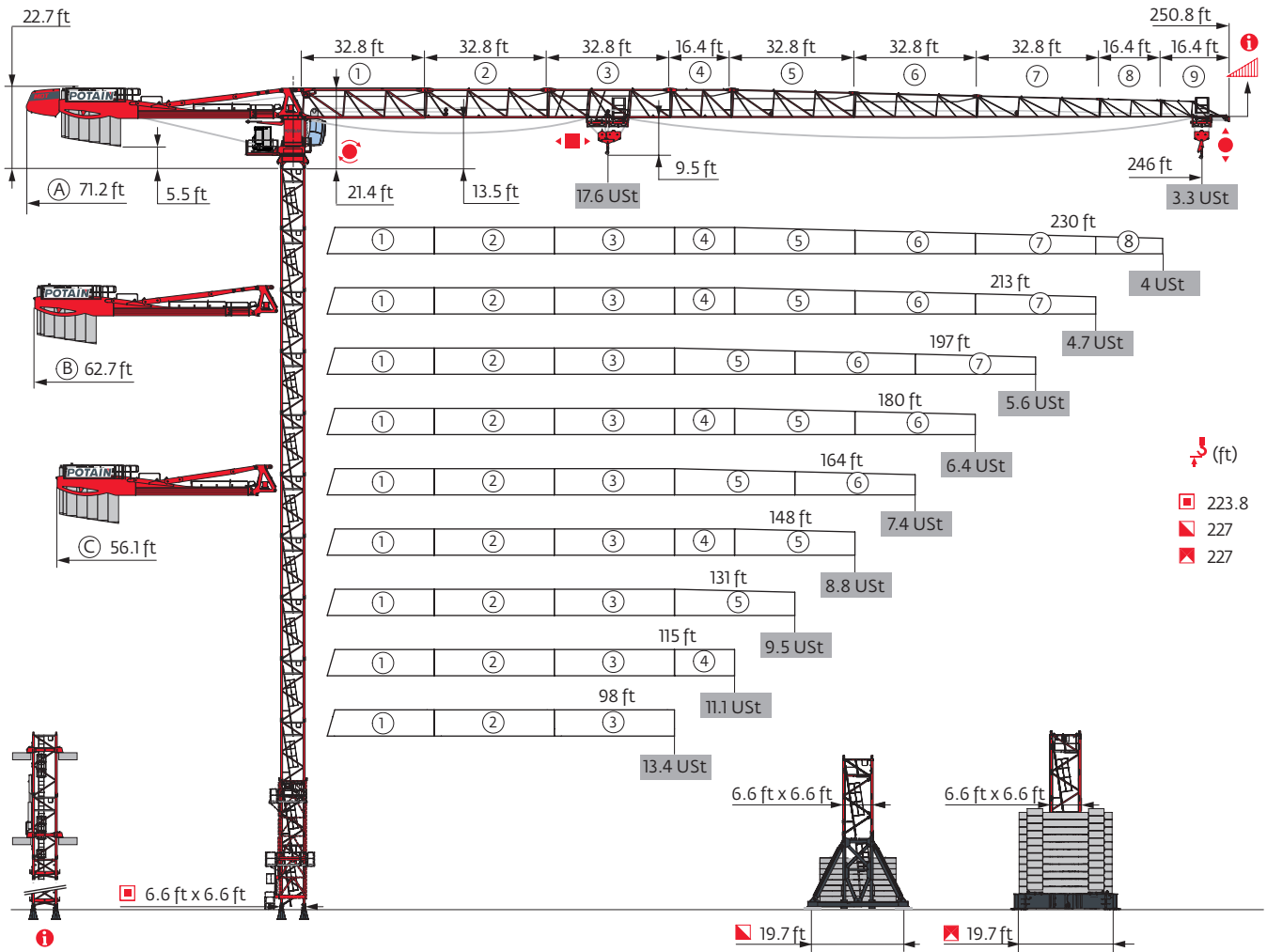

Potain Plus



Power Control

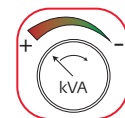

POTAIN CONNECT



Top Site

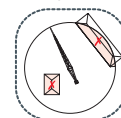

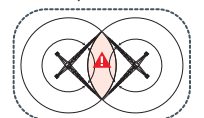

Anti-collision systems







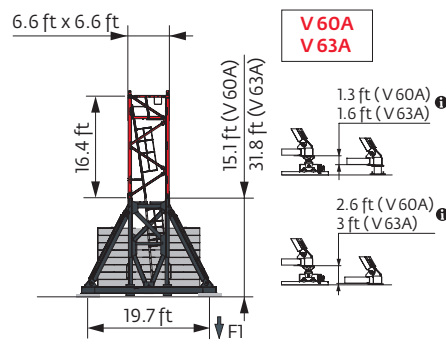
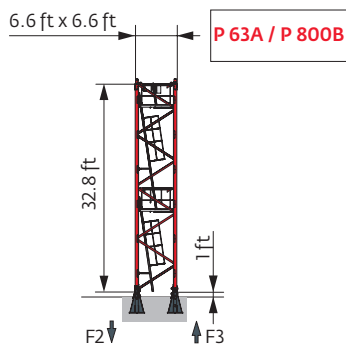

Mast - Reactions

6.6 ft - P 63A										
Height (ft)	98	115	131	148	164	180	197	213	230	246
Height (ft)	223.8	223.8	223.8	218.5	218.5	218.5	218.5	218.5	212.9	212.9
Height/P <sub>r</sub> (ft)	223.8	223.8	223.8	218.5	218.5	218.5	218.5	218.5	212.9	212.9
10.9 ft	2	2	2	0	0	0	0	0	1	1
16.4 ft	10	10	10	11	11	11	11	11	10	10
32.8 ft	1	1	1	1	1	1	1	1	1	1
F2 (USt)	● 229	231	231	225	227	224	224	225	227	229
	■ 287	292	293	273	281	282	286	294	288	296
F3 (USt)	● 161	162	161	154	156	153	153	152	155	156
	■ 228	232	231	211	219	220	224	231	225	233

6.6 ft - V 60A - 										
Height (ft)	98	115	131	148	164	180	197	213	230	246
Height (ft)	216.2	216.2	216.2	210.6	210.6	210.6	210.6	199.8	205.1	199.8
Height/P <sub>r</sub> (ft)	216.2	216.2	216.2	210.6	210.6	210.6	210.6	199.8	205.1	199.8
10.9 ft	0	0	0	1	1	1	1	0	2	0
16.4 ft	12	12	12	11	11	11	11	11	10	11
F1 (USt)	● 127	127	128	122	123	122	121	121	124	123
	■ 130	132	132	123	126	127	129	122	133	129

6.6 ft - V 63A - 										
Height (ft)	98	115	131	148	164	180	197	213	230	246
Height (ft)	227	227	227	221.8	221.8	221.8	221.8	210.6	216.2	216.2
Height/P <sub>r</sub> (ft)	227	227	227	221.8	221.8	221.8	221.8	210.6	216.2	216.2
10.9 ft	1	1	1	2	2	2	2	1	0	0
16.4 ft	11	11	11	10	10	10	10	10	11	11
F1 (USt)	● 134	135	136	130	130	129	129	129	132	132
	■ 150	152	151	140	145	146	148	137	150	155



6.6 ft - ZX 640 - 										
WIND (ft)	98	115	131	148	164	180	197	213	230	246
 (ft)	227	221.5	221.5	216.2	221.5	216.2	216.2	221.5	210.6	216.2
 / P <sub>w</sub> (ft)	227	221.5	221.5	216.2	221.5	216.2	216.2	221.5	210.6	216.2
	10.9 ft	2	0	0	1	0	1	1	0	2
	16.4 ft	10	11	11	10	11	10	10	11	9
	32.8 ft	1	1	1	1	1	1	1	1	1
FI (Ust)	 137	133	134	132	135	130	130	135	134	136
	 146	140	140	135	142	135	137	149	141	151

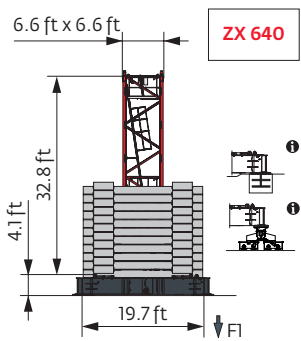

Note: When "ASCE" is noted in this data sheet it is referring to 115 mph Wind Zone, Exposure B, Design Wind Speed = 98 mph. See back cover for design wind speed calculations.

 Motorized accesses: adapted mast compositions, base ballast and reactions.

Other mast compositions - Please consult us

Anchorage



Base ballast

(USt) / 6.6 ft - V 60A -										
Δh (ft)	98	115	131	148	164	180	197	213	230	246
216.2	132.3	132.3	132.3							
210.6	132.3	119.1	119.1	119.1	119.1	119.1	119.1			
205.1	119.1	119.1	119.1	119.1	119.1	105.8	105.8		119.1	
199.8	119.1	119.1	105.8	105.8	105.8	105.8	105.8	119.1	119.1	119.1
183.4	105.8	92.6	92.6	92.6	92.6	92.6	92.6	92.6	92.6	92.6
(ft)	167	79.4	79.4	79.4	79.4	79.4	66.1	79.4	79.4	79.4
	150.6	66.1	66.1	66.1	66.1	66.1	52.9	52.9	66.1	66.1
	134.2	66.1	66.1	66.1	52.9	52.9	52.9	52.9	52.9	66.1
	117.8	66.1	66.1	66.1	52.9	52.9	52.9	52.9	52.9	66.1
	101.4	66.1	66.1	66.1	52.9	52.9	39.7	39.7	52.9	66.1
	85	66.1	66.1	66.1	52.9	52.9	39.7	39.7	39.7	52.9
	68.6	66.1	66.1	66.1	52.9	52.9	39.7	39.7	39.7	52.9

(USt) / 6.6 ft - V 63A -										
Δh (ft)	98	115	131	148	164	180	197	213	230	246
227	145.5	145.5	145.5							
221.8	145.5	132.3	132.3	132.3	132.3	132.3	132.3			
216.2	132.3	132.3	132.3	132.3	132.3	119.1	119.1		132.3	132.3
210.6	132.3	132.3	119.1	119.1	119.1	119.1	119.1	132.3	132.3	132.3
194.2	119.1	105.8	105.8	105.8	105.8	105.8	105.8	105.8	105.8	105.8
(ft)	177.8	92.6	92.6	92.6	92.6	79.4	79.4	92.6	92.6	92.6
	161.4	79.4	79.4	79.4	79.4	66.1	66.1	66.1	79.4	79.4
	145	66.1	66.1	66.1	66.1	52.9	52.9	52.9	66.1	66.1
	128.6	66.1	66.1	66.1	52.9	52.9	52.9	52.9	52.9	66.1
	112.2	66.1	66.1	66.1	52.9	52.9	39.7	39.7	52.9	66.1
	95.8	66.1	66.1	66.1	52.9	52.9	39.7	39.7	39.7	52.9
	79.4	66.1	66.1	66.1	52.9	52.9	39.7	39.7	39.7	52.9
	63	66.1	66.1	66.1	52.9	52.9	39.7	39.7	39.7	52.9

(USt) / 6.6 ft - ZX 640 -										
Δh (ft)	98	115	131	148	164	180	197	213	230	246
227	154.3									
221.5	143.3	143.3	143.3		143.3			143.3		
216.2	143.3	132.3	132.3	143.3	143.3	132.3	132.3	132.3		143.3
210.6	132.3	132.3	132.3	132.3	132.3	132.3	132.3	132.3	143.3	143.3
194.2	110.2	110.2	110.2	110.2	110.2	110.2	110.2	110.2	121.3	121.3
(ft)	177.8	99.2	99.2	88.2	99.2	88.2	88.2	88.2	99.2	99.2
	161.4	77.2	77.2	77.2	77.2	77.2	77.2	66.1	77.2	77.2
	145	66.1	66.1	66.1	66.1	55.1	55.1	55.1	55.1	55.1
	128.6	66.1	66.1	55.1	55.1	44.1	44.1	44.1	44.1	55.1
	112.2	66.1	66.1	55.1	55.1	44.1	44.1	33.1	44.1	55.1
	95.8	66.1	66.1	55.1	55.1	44.1	44.1	33.1	44.1	55.1
	79.4	66.1	66.1	55.1	55.1	44.1	44.1	33.1	44.1	55.1
	63	66.1	66.1	55.1	55.1	44.1	44.1	33.1	44.1	55.1

Load curves



		ft																								ft
		56	66	82	89	98	105	115	121	131	138	148	154	164	180	187	197	213	220	230	236	246	ft			
		17.6 USt												8.8 USt												
246	10.8 → 56.8	101.7 - 110.1	17.6	14.9	11.4	10.4	9.2	8.8	8.4	7.8	7.1	6.7	6.2	5.8	5.4	4.8	4.6	4.3	3.8	3.6	3.3	3.1	2.9	USt		
	10.8 → 58.5	104 - 112.6	17.6	15.4	11.8	10.8	9.4	8.8	8.6	8.1	7.4	7	6.4	6.1	5.6	5	4.8	4.5	4	3.9	3.7	3.5	3.3	USt P+		
230	10.8 → 60.6	108.1 - 117.2	17.6	16.1	12.3	11.2	9.9	9.1	8.8	8.4	7.7	7.2	6.7	6.3	5.8	5.1	4.8	4.5	4	3.9	3.8			USt		
	10.8 → 62.1	110.6 - 119.5	17.6	16.5	12.7	11.6	10.2	9.4	8.8	8.7	7.9	7.5	6.9	6.5	6.1	5.4	5.2	4.8	4.4	4.2	4			USt P+		
213	10.8 → 63.5	114.1 - 123	17.6	17	13.2	12	10.6	9.8	8.8	8.8	8.2	7.7	7	6.7	6.2	5.5	5.2	4.9	4.4					USt		
	10.8 → 65.4	117 - 126.2	17.6	17.5	13.5	12.4	10.9	10.1	9	8.8	8.4	8	7.4	7	6.5	5.8	5.5	5.2	4.7					USt P+		
197	10.8 → 66.7	118.6 - 128	17.6	17.6	13.9	12.6	11.1	10.2	9.2	8.8	8.5	8	7.3	6.9	6.5	5.8	5.6	5.3						USt		
	10.8 → 68.7	123.4 - 132.8	17.6	17.6	14.4	13.1	11.6	10.7	9.6	9	8.8	8.5	7.8	7.4	6.9	6.2	5.9	5.6						USt P+		
180	10.8 → 69.1	124.3 - 133.8	17.6	17.6	14.5	13.2	11.7	10.8	9.7	9.1	8.8	8.5	7.9	7.5	7	6.2								USt		
	10.8 → 71.1	127.9 - 137.8	17.6	17.6	15	13.7	12.1	11.2	10.1	9.4	8.8	8.8	8.1	7.7	7.2	6.4								USt P+		
164	10.8 → 71.6	128.4 - 136.3	17.6	17.6	15.1	13.7	12.1	11.2	10.1	9.5	8.8	8.8	8.1	7.7	7.2									USt		
	10.8 → 73	131.4 - 141.5	17.6	17.6	15.4	14.1	12.5	11.6	10.4	9.7	8.8	8.8	8.4	8	7.4									USt P+		
148	10.8 → 73.6	133.5 - 143.1	17.6	17.6	15.6	14.2	12.6	11.7	10.5	9.9	9	8.8	8.4											USt		
	10.8 → 75.7	136.4 - 147.6	17.6	17.6	16.1	14.7	13	12.1	10.9	10.2	9.2	8.8	8.8											USt P+		
131	10.8 → 73.6		17.6	17.6	15.6	14.1	12.4	11.5	10.4	9.8	8.9													USt		
	10.8 → 76.3		17.6	17.6	16.2	14.9	13.1	12.2	11	10.2	9.3													USt P+		
115	10.8 → 72.9		17.6	17.6	15.5	14.2	12.6	11.7	10.5															USt		
	10.8 → 75.8		17.6	17.6	16.1	14.8	13.1	12.2	11															USt P+		
98	10.8 → 73.9		17.6	17.6	15.3	14.1	12.7																	USt		
	10.8 → 76.7		17.6	17.6	16.3	15	13.3																	USt P+		

$U_{p+} = U - 0.85 U_{St} \text{ max.}$



		ft																								ft
		56	66	82	89	98	105	115	121	131	138	148	154	164	180	187	197	213	220	230	236	246	ft			
		17.6 USt												8.8 USt												
246	8.2 → 57.3	103.2 - 105.3	17.6	15.1	11.6	10.6	9.3	8.8	7.9	7.4	6.7	6.3	5.7	5.4	4.9	4.3	4.1	3.8	3.3	3.1	2.85	2.65	2.45	USt		
	8.2 → 59.1	105.4 - 107.7	17.6	15.6	12	10.9	9.6	8.9	8.2	7.6	6.9	6.5	5.9	5.6	5.2	4.5	4.3	4	3.6	3.4	3.2	3.1	2.85	USt P+		
230	8.2 → 61	109.6 - 112.2	17.6	16.2	12.5	11.4	10	9.3	8.6	8	7.2	6.8	6.2	5.8	5.3	4.6	4.4	4	3.6	3.5	3.3			USt		
	8.2 → 62.5	112 - 114.8	17.6	16.7	12.8	11.7	10.3	9.6	8.8	8.2	7.5	7	6.4	6.1	5.6	4.9	4.7	4.4	3.9	3.8	3.5			USt P+		
213	8.2 → 64	115.7 - 118.1	17.6	17.2	13.3	12.1	10.7	9.9	8.9	8.5	7.7	7.3	6.6	6.2	5.7	5	4.8	4.5	4					USt		
	8.2 → 65.8	118.6 - 121.4	17.6	17.6	13.7	12.5	11	10.2	9.2	8.8	8	7.5	6.9	6.6	6.1	5.4	5.1	4.8	4.3					USt P+		
197	8.2 → 67.3	120.2 - 122.7	17.6	17.6	14	12.8	11.2	10.4	9.3	8.8	8.1	7.6	6.9	6.5	6.1	5.5	5.2	5						USt		
	8.2 → 69.2	125.2 - 128	17.6	17.6	14.5	13.3	11.7	10.9	9.8	9.2	8.6	8.1	7.4	7	6.5	5.8	5.5	5.2						USt P+		
180	8.2 → 69.7	126 - 128.8	17.6	17.6	14.6	13.4	11.8	11	9.9	9.2	8.6	8.1	7.5	7.1	6.6	5.8								USt		
	8.2 → 71.7	129.8 - 132.6	17.6	17.6	15.1	13.8	12.2	11.4	10.2	9.6	8.8	8.4	7.8	7.4	6.8	6.1								USt P+		
164	8.2 → 72.2	129.9 - 131.2	17.6	17.6	15.2	13.9	12.3	11.4	10.3	9.6	8.8	8.4	7.7	7.3	6.8									USt		
	8.2 → 73.6	133.3 - 136.3	17.6	17.6	15.6	14.3	12.6	11.7	10.5	9.9	9	8.7	8	7.6	7.1									USt P+		
148	8.2 → 74.1	135.2 - 137.8	17.6	17.6	15.8	14.4	12.7	11.8	10.7	10	9.2	8.8	8											USt		
	8.2 → 76.3	138.3 - 141.4	17.6	17.6	16.3	14.9	13.2	12.2	11	10.3	9.4	8.9	8.4											USt P+		
131	8.2 → 74.1		17.6	17.6	15.7	14.3	12.6	11.7	10.6	9.9	9													USt		
	8.2 → 76.9		17.6	17.6	16.4	15	13.3	12.3	11.1	10.4	9.5													USt P+		
115	8.2 → 73.5		17.6	17.6	15.6	14.3	12.7	11.8	10.7															USt		
	8.2 → 76.4		17.6	17.6	16.3	15	13.3	12.3	11.1															USt P+		
98	8.2 → 74.5		17.6	17.6	15.5	14.3	12.9																	USt		
	8.2 → 77.3		17.6	17.6	16.5	15.1	13.4																	USt P+		

$W_{p+} = W - 0.25 U_{St} \text{ max.}$

Jib weight & counter-jib ballast

TAVAN	TAVAN (lb) (+/- 5%)								
				10,141 lb	3,373 lb	W (lb)	6,768 lb	3,373 lb	W (lb)
246 ft	40,347	39,256	40,677	5	2	57,452	8	1	57,519
230 ft	39,760	38,702	40,069	5	2	57,452	8	1	57,519
213 ft	38,909	37,917	39,284	5	2	57,452	8	1	57,519
197 ft	36,870	35,944	37,201	5	1	54,079	8	0	54,146
180 ft	36,894	35,968	37,225	5	1	54,079	8	0	54,146
164 ft	35,102	34,176	35,433	5	2	57,452	8	1	57,519
148 ft	34,520	33,594	34,851	5	2	57,452	8	1	57,519
131 ft	32,728	31,802	33,058	5	0	50,706	7	1	50,750
115 ft	31,559	30,633	31,890	4	2	47,311	7	0	47,377
98 ft	29,709	28,784	30,040	4	1	43,938	6	1	43,982

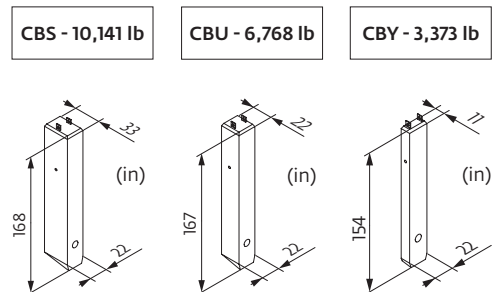





Dimensions and weight

Slewing crane part:  246 ft -  -  90 HPL™

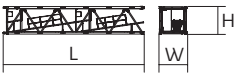
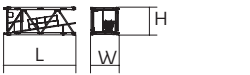
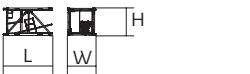
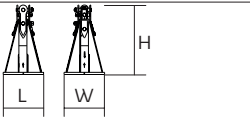

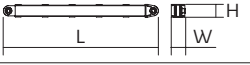
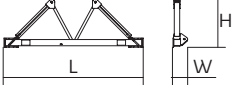
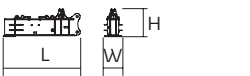
Slewing crane part			L (ft)	W (ft)	H (ft)	lb (+/- 5%)
Counter-jib		Ⓐ	39.4	4.1	8.2	31,107
		Ⓑ	39.4	4.1	8.2	29,983
		Ⓒ	39.4	4.1	8.2	25,441
Cab mast + cab		Ultra View	16.5	7.3	8.2	14,815
Towerhead		□ 6.6 ft	9.7	8.1	8.2	16,799
Hoisting winch (+ rope)		90 HPL™	14	7.5	7.6	9,017
		132 HPL™	15.9	7.5	8.3	15,146
Jib section		① 6 DVF	35.3	5.9	9	12,015
Jib section		②	33.5	3.9	8.2	6,934
		③	33.8	3.9	7.9	5,335
		⑤	33.5	3.9	7.8	3,439
		⑥	33.6	3.9	6.9	2,723
		⑦	33.4	3.9	6	2,094
Jib section		④	17.3	3.9	7.8	2,116
		⑧	16.7	3.9	5	683
		⑨	16.7	3.9	4.6	485
Trolley		 17.6 USt	6.7	5	3.6	1,063
Pulley block		 17.6 USt	4.6	1.5	7.3	1,301
Trolley		 17.6 USt	5.8	5	3.4	551
Trolley		 17.6 USt	5.8	5	3.4	668
		 8.8 USt	6	5	3.4	668
Pulley block		 17.6 USt	6	0.9	6.2	1,863
		 8.8 USt	3.8	0.7	5.2	816

Crane tower		L (ft)	W (ft)	H (ft)	lb (+/- 5%)	
Telescopic cage T 61		6.6 ft	35.5	13.6	14.7	21,385
K 649B KM 649E KRM 6410B		6.6 ft	33.6 33.8 33.6	6.8 6.7 6.9	6.7 6.7 6.8	11,663 10,692 15,653
K 649A KMT 649A KR 649A KRMT 649A		6.6 ft	17.2 17.2 17.2 17.2	6.8 6.8 6.9 6.9	6.7 6.7 6.8 6.8	6,184 5,666 7,165 6,724
K 649C KMT 649C KRMT 649C		6.6 ft	11.7 11.7 11.7	6.8 6.8 6.9	6.7 6.7 6.8	4,559 4,542 5,401
Fixing angles		P 63A / P 800B	2.5	2.5	4.2	1,025
Basic mast unit		V 60A V 63A	16.4 32.9	7.9 7.9	7.9 7.9	10,494 16,887
Struts		V 60A V 63A	14.8 14.8	1 1.1	1 1.1	1,036 1,235
Half-bearer		V 60A V 63A	22 22	2.3 2.3	7.6 7.6	4,057 4,101
1/2 Cross girder		ZX 640	14.3	3.3	5.1	7,319
Cross girder		ZX 640	30	3.9	5.1	15,168

Mechanisms

480 V - 60 Hz													hp	kW	
	90 HPL™ 40	fpm	133	174	249	366	548	69	90	130	190	274	90	66	1,768 ft
		USt	8.8	6.6	4.4	2.2	0.6	17.6	13.2	8.8	4.4	1.5			
	132 HPL™ 40	fpm	198	259	363	525	671	102	135	189	269	336	132	98	3,740 ft
		USt	8.8	6.6	4.4	2.2	0.8	17.6	13.2	8.8	4.4	2			
	6 DVF 6 Optima	fpm	0 → 138 (17.6 USt) 0 → 276 (8.8 USt) 0 → 328 (4.4 USt)									5.5	4		
	RVF 172 Optima+	rpm	0 → 0.9									2 x 10	2 x 7.5		

480 V (+6% -10%) 60 Hz	90 HPL™: 96 → 60 kVA	
	132 HPL™: 130 → 77 kVA	

These mast combinations meet the EN 14439 and ASME B30.3-2016 specifications for “out of service” wind conditions, provided the illustrated wind speed matches required design wind speed for the location of the tower crane. The “out of service” design wind speed was determined in accordance with ASCE 7-10, Figure 26.5-1A. The wind velocity, used for this configuration was 98 mph (158 kph), which represents a nominal design 3-second wind gust at 33 ft (10 m) above ground for Exposure B category. A factor of 0.85 was applied to the 700-year ultimate design wind speed of 115 mph (185 kph), per ASCE 37-02, with the assumption that this crane is considered a temporary structure used during a construction period of 2 years or less.

- Jib elevation
- Standard equipment
- Options
- Potain Plus function: Plus load curves
- Hook heights with Plus load curves
- Reactions in service
- Reactions out of service
- Total ballast weight
- Jib weight
- Lorry 44 ft
- Container High Cube 40 ft, and/or Flat Rack 20 ft
- Hoisting
- Trolleying
- Slewing
- Travelling
- Required power
- Power Control Function: winch speeds adapted to the available power
- Consult us

This commercial document is not legally binding. For any technical information, please refer to the corresponding instructions.

