

MDT 269 J12

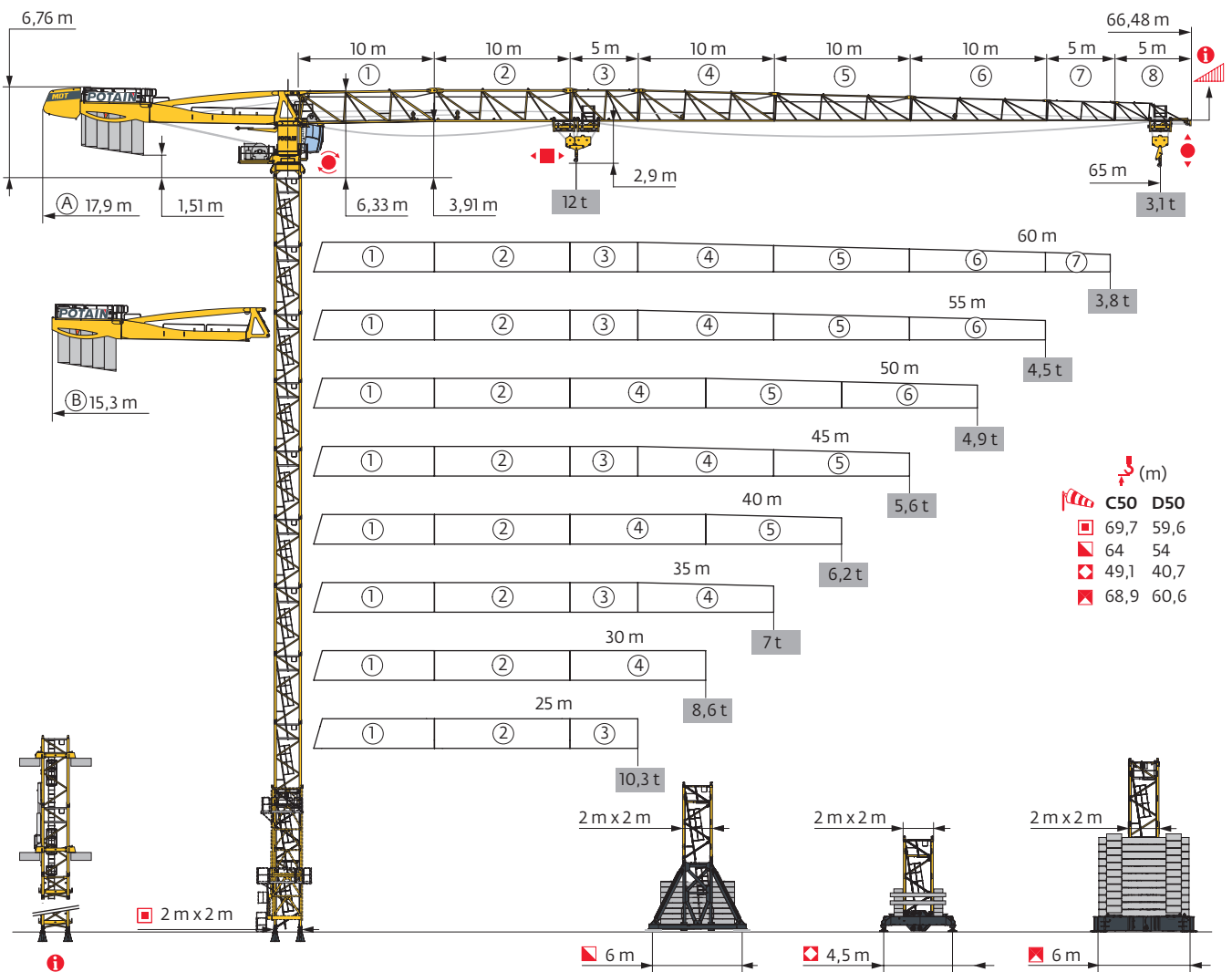

Potain Plus



Power Control

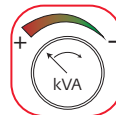



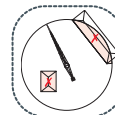

Top Site

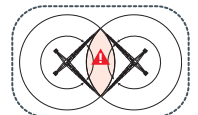











Anti-collision systems



Mât - Réactions / Mast - Reaktionskräfte / Mast - Reactions / Mástil - Reacciones / Torre - Reazioni
 Tramo - Reacções / Реакция опор мачты

2 m - P 63A - C50									
AVAN (m)	25	30	35	40	45	50	55	60	65
 (m)	69,7	69,7	68	68	68	68	68	68	68
 / P _r (m)	69,7	69,7	68	68	68	68	68	68	68
	3,33 m	1	1	2	2	2	2	2	2
	5 m	11	11	10	10	10	10	10	10
	10 m	1	1	1	1	1	1	1	1
F2 (t)	● 183	182	182	182	182	183	183	190	191
	■ 370	370	359	356	363	365	363	360	366
F3 (t)	● 131	130	128	127	127	127	125	131	132
	■ 324	323	311	308	314	315	311	307	313
 (m) D50	59,6	59,6	59,6	59,6	59,6	59,6	59,6	59,6	59,6
 / P _r (m) D50	59,6	59,6	59,6	59,6	59,6	59,6	59,6	59,6	59,6

2 m - V 60A - C50									
AVAN (m)	25	30	35	40	45	50	55	60	65
 (m)	57,3	57,3	57,3	57,3	57,3	57,3	57,3	58,9	57,3
 / P _r (m)	57,3	57,3	57,3	57,3	57,3	57,3	57,3	58,9	57,3
	3,33 m	2	2	2	2	2	2	1	2
	5 m	9	9	9	9	9	9	10	9
	F1 (t)	● 97	96	98	94	98	98	98	103
■ 128		127	130	128	132	132	130	141	133
 (m) D50	47,3	48,9	48,9	48,9	48,9	48,9	48,9	48,9	48,9
 / P _r (m) D50	47,3	48,9	48,9	48,9	48,9	48,9	48,9	48,9	48,9

2 m - V 63A - C50									
AVAN (m)	25	30	35	40	45	50	55	60	65
 (m)	62,3	62,3	62,3	64	62,3	62,3	64	64	62,3
 / P _r (m)	62,3	62,3	62,3	64	62,3	62,3	64	64	62,3
	3,33 m	2	2	2	1	2	2	1	2
	5 m	9	9	9	10	9	9	10	9
	F1 (t)	● 113	113	114	115	114	115	119	120
■ 161		160	163	169	165	165	172	171	166
 (m) D50	52,3	54	54	54	54	54	54	54	54
 / P _r (m) D50	52,3	54	54	54	54	54	54	54	54

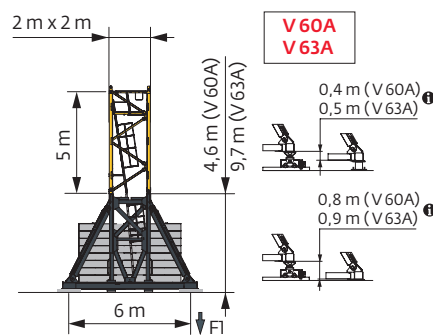
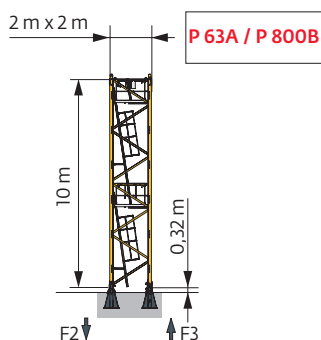

i Autres compositions de pylône - Nous consulter. / Andere Turmaufbauten - bitte kontaktieren Sie uns. / Other mast compositions - Please consult us. / Para otras composiciones de mástil - Por favor contáctenos. / Per altre composizioni torre, contattateci. / Para outras composições de coluna - Por favor, consulte-nos. / Для других композиций мачты пожалуйста консультируйтесь с нами.

Accès motorisés : compositions de mâture, de lest de base et réactions adaptées. / Motorisierter Zugang vom : Mastzusammensetzung, Grundballast und Reaktionskräfte sind angepasst. / Motorized accesses: adapted mast composition, base ballast and reactions. / Acceso a cabina con elevador: Adaptación de composición de mástil, lastre de base y reacciones. / Accessi motorizzati: composizioni elementi torre, zavorre di base e reazioni aggiornate. / Acessos motorizados: composições de coluna, lastro da base e reacções adaptadas. / Лифты : адаптированная композиция мачты, базовый балласт и нагрузки.

2 m - ZD 463 - C50										
ΔΔΔ (m)	25	30	35	40	45	50	55	60	65	
h (m)	47,4	49,1	47,4	49,1	47,4	47,4	47,4	45,7	45,7	
h/P+ (m)	47,4	49,1	47,4	49,1	47,4	47,4	47,4	45,7	45,7	
Z	3,33 m	0	2	0	2	0	0	0	1	1
	5 m	9	8	9	8	9	9	9	8	8
FI (t)	● 98	101	99	101	98	98	103	101	102	
	■ 115	124	117	125	119	119	118	108	113	
h (m) D50	40,7	40,7	40,7	40,7	40,7	40,7	40,7	40,7	40,7	
h/P+ (m) D50	40,7	40,7	40,7	40,7	40,7	40,7	40,7	40,7	40,7	

2 m - ZX 640 - C50										
ΔΔΔ (m)	25	30	35	40	45	50	55	60	65	
h (m)	68,9	68,9	68,9	68,9	68,9	68,9	68,9	68,9	67,3	
h/P+ (m)	68,9	68,9	68,9	68,9	68,9	68,9	68,9	68,9	67,3	
Z	3,33 m	2	2	2	2	2	2	2	0	
	5 m	10	10	10	10	10	10	10	11	
	10 m	1	1	1	1	1	1	1	1	
FI (t)	● 127	128	129	130	133	133	131	134	130	
	■ 191	191	193	192	196	196	195	193	185	
h (m) D50	58,9	58,9	58,9	58,9	58,9	58,9	58,9	60,6	58,9	
h/P+ (m) D50	58,9	58,9	58,9	58,9	58,9	58,9	58,9	60,6	58,9	

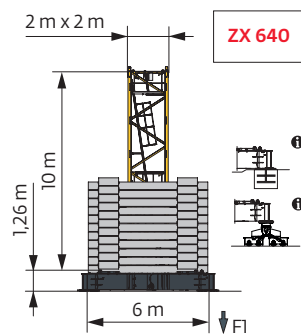
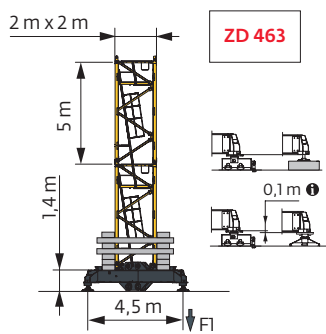



Ancrages / Verankerungen / Anchorages / Anclajes / Ancoraggi
 Ancoragem / крепления



Lest de base / Grundballast / Base ballast / Lastre de base / Zavorra di base
 Lastro da base / Базовый Балласт

 (t) / 2 m - V 60A - C50										
▲▼▲ (m)	25	30	35	40	45	50	55	60	65	
58,9										132
57,3	132	132	132	120	132	132	120	120	120	120
52,3	96	96	96	96	96	96	96	96	96	96
47,3	72	72	72	72	60	72	72	72	72	72
↓ (m)	42,3	60	60	60	60	48	48	60	60	60
	37,3	48	48	48	48	36	36	48	48	48
	32,3	48	48	48	48	36	36	36	36	36
	27,3	48	48	48	48	36	36	36	24	24
	22,3	48	48	48	48	36	36	36	24	24
	17,3	48	48	48	48	36	36	36	24	24

 (t) / 2 m - V 63A - C50										
▲▼▲ (m)	25	30	35	40	45	50	55	60	65	
64				180				180	180	
62,3	180	180	180	168	180	180	168	168	168	
57,3	132	132	132	132	132	132	132	120	132	
52,3	108	96	108	96	96	108	96	96	96	
↓ (m)	47,3	72	72	72	72	72	72	72	72	72
	42,3	60	60	60	60	48	48	60	60	60
	37,3	48	48	48	48	36	36	48	48	48
	32,3	36	36	36	36	36	36	36	36	36
	27,3	36	36	36	36	36	36	36	24	24
	22,3	36	36	36	36	36	36	36	24	24

 (t) / 2 m - ZD 463 - C50										
▲▼▲ (m)	25	30	35	40	45	50	55	60	65	
49,1			125			125				
47,4	120	120	120	115	115	115	125			
45,7	115	110	115	110	105	105	120	120	120	
↓ (m)	40,7	95	95	95	90	85	85	100	100	100
	35,7	80	80	75	75	75	75	80	80	80
	30,7	80	80	75	75	75	75	70	60	60
	25,7	80	80	75	75	75	75	70	60	55
	20,7	80	80	75	75	75	75	70	60	55

 (t) / 2 m - ZX 640 - C50										
▲▼▲ (m)	25	30	35	40	45	50	55	60	65	
68,9	210	210	210	210	220	220	210	210		
67,3	200	200	200	190	200	200	200	190	200	
62,3	160	150	150	150	160	160	150	150	150	
57,3	120	120	120	110	120	120	110	120	120	
↓ (m)	52,3	90	90	90	90	90	90	90	100	100
	47,3	80	70	70	80	70	70	70	80	80
	42,3	60	60	60	60	60	60	50	60	60
	37,3	50	50	50	50	40	40	40	50	50
	32,3	40	40	40	40	40	40	30	30	30
	27,3	40	40	40	40	40	40	30	20	20
	22,3	40	40	40	40	40	40	30	20	20

Courbes de charges / Lastkurven / Load curves / Curvas de cargas / Curve di carico / Curvas de carga / Кривые нагрузок



(m)		17	20	22	25	27	30	32	35	37	40	42	45	47	50	52	55	57	60	62	65	m	
12 t	6 t																						
65	3,1 → 18,9 3,1 → 20,1	12	11,3	10,2	8,8	8,1	7,2	6,6	6	6	5,5	5,2	4,8	4,5	4,1	3,9	3,6	3,5	3,3	3,1	2,95	t	
		12	12	10,9	9,4	8,6	7,6	7	6,2	6	5,8	5,4	5	4,7	4,4	4,2	3,9	3,7	3,5	3,3	3,1	t P+	
60	3,1 → 20,2 3,1 → 21,2	12	12	10,9	9,5	8,7	7,7	7,2	6,5	6	5,9	5,5	5,1	4,8	4,4	4,2	3,9	3,7	3,5			t	
		12	12	11,5	10	9,2	8,1	7,5	6,7	6,3	6	5,8	5,3	5,1	4,7	4,5	4,2	4	3,8			t P+	
55	3,1 → 20,1 3,1 → 21,1	12	12	10,8	9,4	8,6	7,6	7,1	6,4	6	6	5,6	5,2	5	4,6	4,4	4,2					t	
		12	12	11,5	10	9,2	8,2	7,7	6,9	6,5	6	6	5,7	5,4	5	4,8	4,5					t P+	
50	3,1 → 20 3,1 → 20,7	12	11,9	10,7	9,3	8,5	7,5	6,9	6,2	6	5,8	5,5	5,1	4,8	4,5							t	
		12	12	11,3	9,8	9	8	7,5	6,7	6,3	6	6	5,5	5,3	4,9							t P+	
45	3,1 → 20 3,1 → 20,9	12	12	10,8	9,3	8,5	7,5	6,9	6,2	6	5,8	5,5	5,1									t	
		12	12	11,4	9,9	9,1	8,1	7,5	6,8	6,4	6	6	5,6									t P+	
40	3,1 → 20,6 3,1 → 21,8	12	12	11,2	9,7	8,9	7,9	7,4	6,6	6,2	6											t	
		12	12	11,9	10,3	9,5	8,5	7,9	7,1	6,7	6,1											t P+	
35	3,1 → 20,1 3,1 → 21,2	12	12	10,9	9,4	8,7	7,7	7,1	6,4													t	
		12	12	11,5	10,1	9,3	8,3	7,7	6,9													t P+	
30	3,1 → 20,8 3,1 → 21,9	12	12	11,3	9,8	9	8															t	
		12	12	11,9	10,4	9,6	8,5															t P+	
25	3,1 → 20,5 3,1 → 21,6	12	12	11,1	9,7																	t	
		12	12	11,8	10,3																	t P+	

$U_{12} = U_6 - 0,53 \text{ t max.}$



(m)		17	20	22	25	27	30	32	35	37	40	42	45	47	50	52	55	57	60	62	65	m	
12 t	6 t																						
65	2,4 → 19 2,4 → 20,2	12	11,4	10,3	8,9	8,2	7,2	6,7	6	5,7	5,2	4,8	4,4	4,1	3,8	3,6	3,3	3,1	2,95	2,8	2,6	t	
		12	12	11	9,5	8,6	7,6	7	6,3	5,9	5,4	5,1	4,7	4,4	4	3,8	3,6	3,4	3,2	3	2,8	t P+	
60	2,4 → 20,3 2,4 → 21,3	12	12	11	9,6	8,8	7,8	7,2	6,5	6,1	5,6	5,2	4,8	4,5	4,1	3,9	3,6	3,4	3,2			t	
		12	12	11,6	10,1	9,2	8,2	7,5	6,8	6,3	5,8	5,5	5	4,8	4,4	4,2	3,9	3,7	3,5			t P+	
55	2,4 → 20,2 2,4 → 21,2	12	12	10,9	9,4	8,7	7,7	7,1	6,4	6	5,7	5,3	4,9	4,7	4,3	4,1	3,9					t	
		12	12	11,5	10,1	9,3	8,3	7,7	7	6,6	6	5,8	5,4	5,1	4,7	4,5	4,2					t P+	
50	2,4 → 20,1 2,4 → 20,8	12	12	10,8	9,3	8,5	7,5	7	6,3	6	5,5	5,2	4,8	4,5	4,2							t	
		12	12	11,3	9,9	9,1	8,1	7,5	6,8	6,4	5,9	5,7	5,2	5	4,6							t P+	
45	2,4 → 20,1 2,4 → 21	12	12	10,8	9,4	8,6	7,6	7	6,3	6	5,5	5,2	4,8									t	
		12	12	11,4	10	9,2	8,2	7,6	6,9	6,5	6	5,7	5,3									t P+	
40	2,4 → 20,7 2,4 → 21,8	12	12	11,3	9,8	9	8	7,4	6,7	6,3	5,9											t	
		12	12	11,9	10,4	9,6	8,5	8	7,2	6,8	6,2											t P+	
35	2,4 → 20,2 2,4 → 21,3	12	12	10,9	9,5	8,7	7,7	7,2	6,5													t	
		12	12	11,6	10,2	9,3	8,3	7,8	7													t P+	
30	2,4 → 20,9 2,4 → 22	12	12	11,3	9,9	9,1	8,1															t	
		12	12	12	10,5	9,6	8,6															t P+	
25	2,4 → 20,6 2,4 → 21,7	12	12	11,2	9,7																	t	
		12	12	11,8	10,3																	t P+	



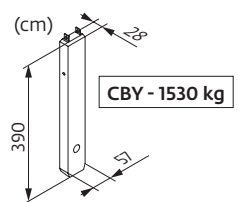
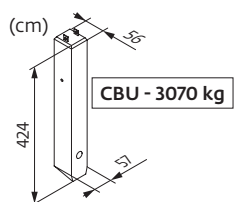
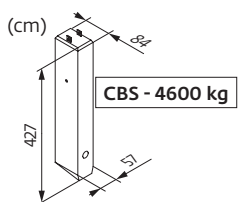

$W_{12} = W_6 - 0,17 \text{ t max.}$

Poids de flèche & lest de contre-flèche / Auslegergewicht & Gegenauslegerballast / Jib weight & counter-jib ballast / Peso de flecha y lastre de contra-flecha/Peso del braccio & zavorra di contro-braccio/Peso da lança & lastro da contra lança/Вес стрелы и балласт контр-стрелы









m	▲▲▲▲ (kg) (+/- 5%)			▨		▨			
	↔	↔	↔	4600 kg	1530 kg	▲ (kg)	3070 kg	1530 kg	▲ (kg)
65 m	12590	12240	12685	5	1	24530	7	2	24550
60 m	12290	11965	12360	5	1	24530	7	2	24550
55 m	11985	11660	12055	5	0	23000	7	1	23020
50 m	11140	10820	11210	4	1	19930	6	1	19950
45 m	11285	10960	11355	4	1	19930	6	1	19950
40 m	10475	10150	10545	4	0	18400	6	0	18420
35 m	10355	10030	10425	3	2	16860	5	1	16880
30 m	9400	9080	9470	3	1	15330	5	0	15350
25 m	8870	8550	8940	3	0	13800	4	1	13810

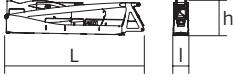

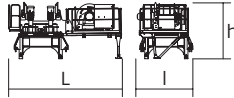
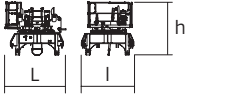
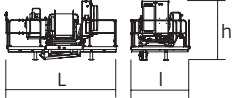



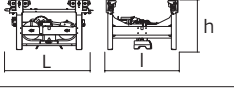

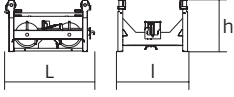
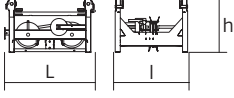
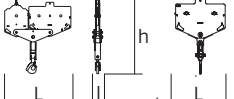
Encombrenment et poids / Abmessungen und Gewicht / Dimensions and weight / Dimensiones y peso / Ingombro e peso
 dimensões e pesos / габаритные размеры и вес

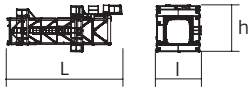
Partie tournante / Drehender Kranteil / Slewing crane part / Parte giratoria
 Parte rotante / Parte rotativa / Поворотная часть :  65 m -  -  -  50 LVF

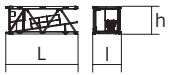

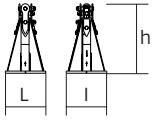
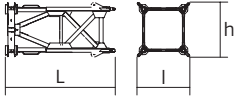
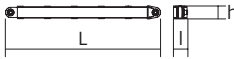
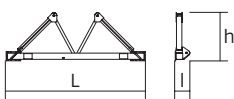
Partie tournante / Drehender Kranteil / Slewing crane part Parte giratoria / Parte rotante / Parte rotativa Поворотная часть		L (m)	I (m)	h (m)	kg (+/- 5%)
Contre-flèche / Gegenausleger Counter-jib / Contra-flecha Controbraccio / Contra-lança Контр-стрела		11 11	1,17 1,17	2,47 2,47	8715 8450
Mât-cabine + cabine / Kabinenmast + Kabine Cab mast + cab / Mástil-cabina + cabina Portaralla superiore + cabina / Tramo-cabina + cabina Секция мачты кабины + кабина		4,9	2,22	2,49	5300
Pivot + treuil de levage (+ câble) / Krankopf + Hubwerk (+ Seil) Towerhead + Hoisting winch (+ rope) Pivote + Mecanismo de elevación (+ cabo) Portaralla + Argano di sollevamento (+ fune) Pivot + Guincho de elevação (+ cabo) Секция поворотной части + Подъемная лебедка (+ канатом)		5,14	2,51	2,76	8475
Pivot / Krankopf Towerhead / Pivote Portaralla / Pivot Секция поворотной части		2,83	2,46	2,47	5300
Treuil de levage (+ câble) / Hubwerk (+ Seil) Hoisting winch (+ rope) / Mecanismo de elevación (+ cabo) Argano di sollevamento (+ fune) Guincho de elevação (+ cabo) Подъемная лебедка (+ канатом)		4,27	2,3	2,32	4500
Elément de flèche / Auslegerement Jib section / Elemento de flecha Elemento di braccio / Elemento de lança Секция стрелы		10,83	1,72	2,74	3610
Elément de flèche / Auslegerement Jib section / Elemento de flecha Elemento di braccio / Elemento de lança Секция стрелы		② ④ ⑤ ⑥	1,2 1,2 1,2 1,2	2,42 2,39 2,1 1,83	2420 1560 1235 795
Elément de flèche / Auslegerement jib section / Elemento de flecha Elemento di braccio / Elemento de lança Секция стрелы		③ ⑦ ⑧	1,2 1,2 1,2	2,39 1,53 1,39	960 310 220
Chariot / Laufkatze Trolley / Carrello Carro / Carro-distribuidor Тележка		1,87	1,51	1,05	400
Moufle / Hubflasche Pulley block / Aparejo Bozzello / Cadernal Полиспаст		1,19	0,43	2,31	455
Chariot / Laufkatze Trolley / Carrello Carro / Carro-distribuidor Тележка		1,57	1,51	0,98	210
Chariot / Laufkatze Trolley / Carrello Carro / Carro-distribuidor Тележка		1,7 1,86	1,51 1,51	1,03 0,98	245 236
Moufle / Hubflasche Pulley block / Aparejo Bozzello / Cadernal Полиспаст		1,65 1,09	0,22 0,27	1,78 1,62	450 265

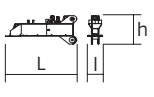
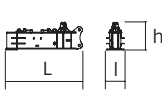
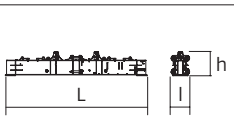
Рулоне / Kranturm / Crane tower Mástil / Torre / Torre Башня крана		L (m)	l (m)	h (m)	kg (+/- 5%)	
T 61		10,83	4,14	4,47	9700	
K 649B KM 649E KRM 6410B		10,23 10,29 10,23	2,07 2,03 2,1	2,03 2,03 2,08	5290 4850 7100	
KR 649A KRMT 649A K 649A KMT 649A		5,23 5,23 5,23 5,23	2,1 2,1 2,07 2,07	2,08 2,08 2,03 2,03	3250 3050 2805 2570	
K 649C KMT 649C KRMT 649C		3,57 3,57 3,57	2,07 2,07 2,1	2,03 2,03 2,08	2070 2060 2450	
Pieds de scellement / Verankerungsfüße Fixing angles / Pie de empotramiento Montante da annegare / Angulos fixadores анкера		P 63A / P 800B	0,75	0,75	1,28	465
Mât-châssis / Grundmasteinheit Basic mast unit / Tramo-chasis Elemento base / Tramo-chassis Мачта для крепления к шасси		V 60A V 63A	5,01 10,02	2,41 2,41	2,41 2,41	4760 7660
Haubans / Mastabstützungen Struts / Tornapuntas Puntoni / Escoras Растяжка		V 60A V 63A	4,51 4,51	0,29 0,33	0,29 0,33	470 560
Sommier / Unterwagenhälfte Half-bearer / Testero Testata / Estrutura base Траверса		V 60A V 63A	6,7 6,7	0,7 0,7	2,31 2,31	1840 1860
Bras de croix / Fundamentkruzträger Cross girder / Brazo en cruz Braccio croce / Braço da cruz Поперечная балка		ZD 463	7,65	1,17	1,36	3585
1/2 Bras de croix / 1/2 Fundamentkruzträger 1/2 Cross girder / 1/2 Brazo en cruz 1/2 Braccio croce / 1/2 Braço da cruz 1/2 Поперечная балка		ZD 463	3,41	0,7	1,35	1655
1/2 Bras de croix / 1/2 Fundamentkruzträger 1/2 Cross girder / 1/2 Brazo en cruz 1/2 Braccio croce / 1/2 Braço da cruz 1/2 Поперечная балка		ZX 640	4,35	1	1,56	3320
Bras de croix / Fundamentkruzträger Cross girder / Brazo en cruz / Braccio croce / Braço da cruz Поперечная балка		ZX 640	9,15	1,19	1,56	6880

Mécanismes / Triebwerke / Mechanisms / Mecanismos / Meccanismi
 Механизмы / Механизмы

400 V - 50 Hz												ch - PS	kW	
	50 LVF 30 Optima	m/min	32	41	56,5	81,5	16,5	21,5	29,5	41	50	37	337 m	
		t	6	4,5	3	1	12	9	6	2,3				
	75 HPL™ 30	m/min	44	57,5	82	140	220,5	23	30	43,5	74	110	845 m	
		t	6	4,5	3	1,5	0,2	12	9	6	3	0,8		
	6 DVF 4 Optima	m/min	0 → 50 (12 t) 0 → 100 (6 t) 0 → 120 (3 t)					5,5	4					
	RVF 162 Optima+	tr/min U/min rpm	0 → 0,8					2 x 7,5	2 x 5,5					

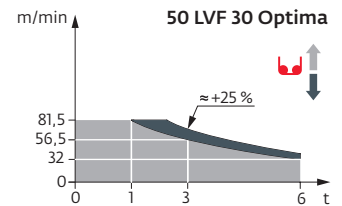

	IEC 60204-32		kVA
400 V (+10% -10%) 50 Hz		50 LVF : 58 → 38 kVA 75 HPL™ : 78 → 48 kVA	

	FR	DE	EN	ES	IT	PT	RU
	Profil de vent suivant EN 14439 C50-D50	Windbedingungen gemäss EN 14439 C50-D50	Wind conditions according to EN 14439 C50-D50	Conformidad de los condiciones de viento EN 14439 C50-D50	Condizioni del vento secondo EN 14439 C50-D50	Perfil de vento conforme EN 14439 C50-D50	Ветровой режим в соответствии с EN 14439 C50-D50
	Appel de flèche	Auslegerüberhöhung	Jib elevation	Elevación de la flecha	Inclinazione braccio	Desvio da lança	подъем стрелы
	Équipements standards	Standardausrüstungen	Standard equipment	Equipamiento de serie	Equipaggiamento standard	Equipamento de série	Стандартное оборудование
	Équipements optionnels	Sonderausrüstungen	Options	Equipamiento opcional	Equipaggiamento in opzione	Equipamento opcional	Дополнительное оборудование (опция)
	Fonction Potain Plus : Courbes de charges Plus	Funktion Potain Plus: Plus-Lastkurven	Potain Plus function: Plus load curves	Función Potain Plus: Diagrama de cargas Plus	Funzione Potain Plus: Curve di carico Plus	Função Potain Plus: Diagrama de cargas Plus	Функция контроля мощности Potain Plus: Диаграммы грузоподъемности Plus
	Hauteurs sous crochet associées aux courbes de charges Plus	Hakenhöhen mit Plus-Lastkurven	Hook heights with Plus load curves	Altura bajo gancho, usando el diagrama de cargas Plus	Altezze sotto gancio con curve di carico Plus	Altura livre, utilizando o diagrama de cargas Plus	Высота под крюком для диаграмм грузоподъемности Plus
	Réactions en service	Reaktionskräfte in Betrieb	Reactions in service	Reacciones en servicio	Reazioni in servizio	Reacções em serviço	Реакция при работе
	Réactions hors service	Reaktionskräfte außer Betrieb	Reactions out of service	Reacciones fuera de servicio	Reazioni fuori servizio	Reacções fora de serviço	Реакция в покое
	Poids total du lest	Ballast-Gesamtgewicht	Total ballast weight	Peso total del lastre	Peso totale della zavorra	Peso total do lastro	Общий вес балласта
	Poids de flèche	Auslegergewicht	Jib weight	Peso de flecha	Peso del braccio	Peso da lança	вес стрелы
	Camion 13,4 m	Lkw 13,4 m	Lorry 13,4 m	Camión 13,4 m	Camion 13,4 m	Camião 13,4 m	Рзровой автомобиль 13,4 м
	Conteneur High Cube 40', et/ou Flat Rack 20'	Container High Cube 40', und/oder Flat Rack 20'	Container High Cube 40', and/or Flat Rack 20'	Contenedor High Cube 40', y/o Flat Rack 20'	Contentor High Cube 40', e/o Flat Rack 20'	Contentor High Cube 40', e/ou Flat Rack 20'	40-футовый контейнер повышенной вместимости High Cube, и/или 20-футовая открытая платформа Flat Rack
	Levage	Heben	Hoisting	Elevación	Sollevamento	Elevação	Подъем
	Distribution	Katzfahren	Trolleying	Distribución	Ditribuzione	Distribuição	Перемещение по стреле
	Orientation	Schwenken	Slewing	Orientación	Rotazione	Rotação	Поворот
	Translation	Kranfahren	Travelling	Traslación	Traslazione	Translação	Перемещение крана
	Puissance requise	Erforderliche Leistung	Required power	Potencia Necesaria	Potenza richiesta	Potência Necessária	Потребляемая мощность
	Fonction Power Control : vitesses treuils adaptés à la puissance disponible	Funktion Power Control: Geschwindigkeiten der Triebwerke werden an die verfügbare Leistung angepasst	Power Control Function: winch speeds adapted to the available power	Función Power Control: marchas de los cabrestantes adaptadas a la potencia disponible	Funzione Power Control: velocità degli argani adattate alla potenza disponibile	Função Power Control: velocidades de guincho adaptadas à potência disponível	Функция контроля мощности Power Control: регулировка скорости лебедок в зависимости от доступной мощности
	Nous consulter	Auf Anfrage	Consult us	Consultarnos	Consultateci	Consultar-nos	Проконсультируйтесь у нас
	Document commercial non contractuel. Pour toute information technique se référer à la notice correspondante.	Unverbindliches Vertriebsdokument. Für technische Informationen, siehe die entsprechenden Anweisungen.	This commercial document is not legally binding. For any technical information, please refer to the corresponding instructions.	Documento comercial no contractual. Para cualquier información técnica, ver la noticia correspondiente.	Documento commerciale non vincolante, per tutte le informazioni tecniche fare riferimento al catalogo istruzioni.	Documento comercial não contratual. Para qualquer informação técnica complementar consultar as respectivas instruções.	Этот коммерческий документ не является юридически обязательным. Для получения технической информации, см. соответствующие инструкции.

