

MC 175C

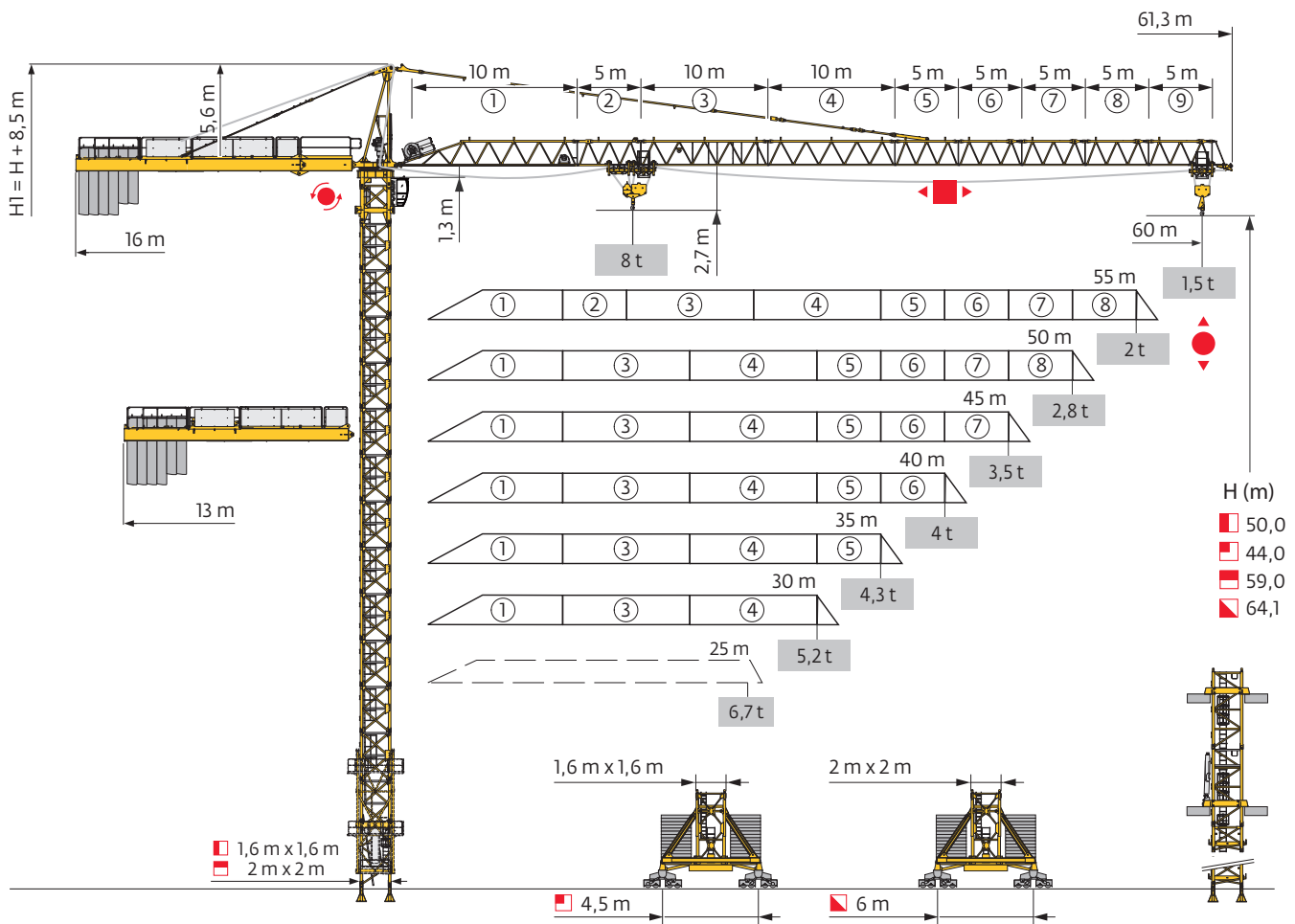

Mât - Réactions / Mast - Reaktionskräfte / Mast - Reactions / Mástil - Reacciones / Torre - Reazioni
 Tramo - Reações / Реакция опор мачты

1,6 m

30 m → 60 m

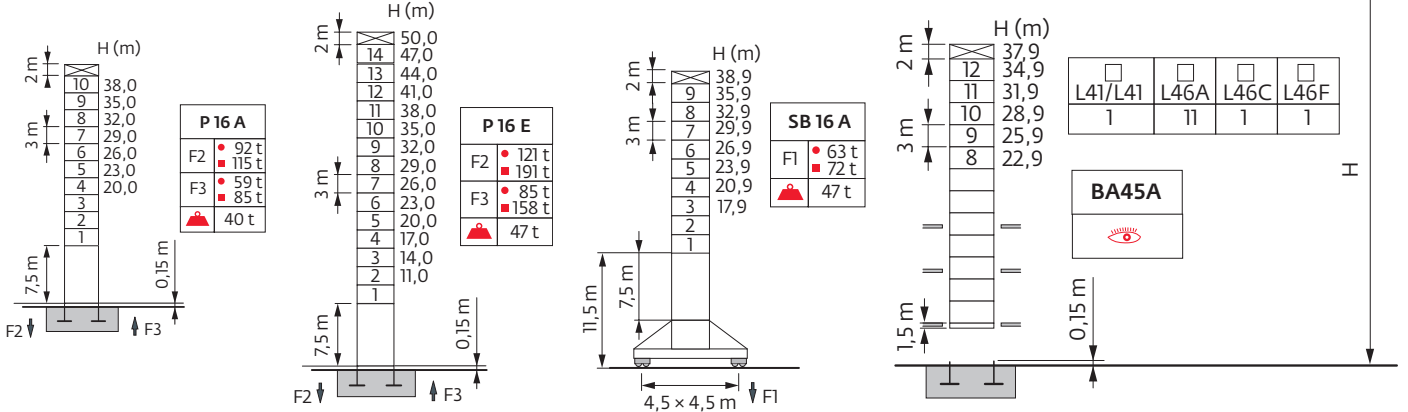

2 m

30 m → 60 m

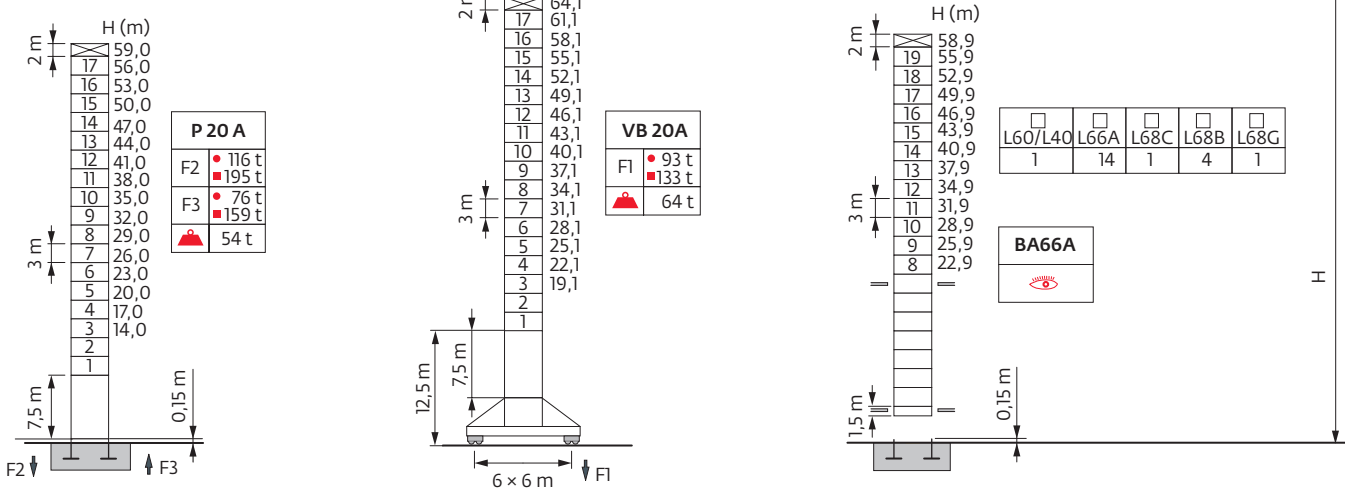

Télescopage sur dalles / Kletterkrane im Gebäude / Climbing Crane / Telescopage grua trepadora / Gru in cavedio
 Telescopagem sobre lajes / Кран, ползущий внутри здания

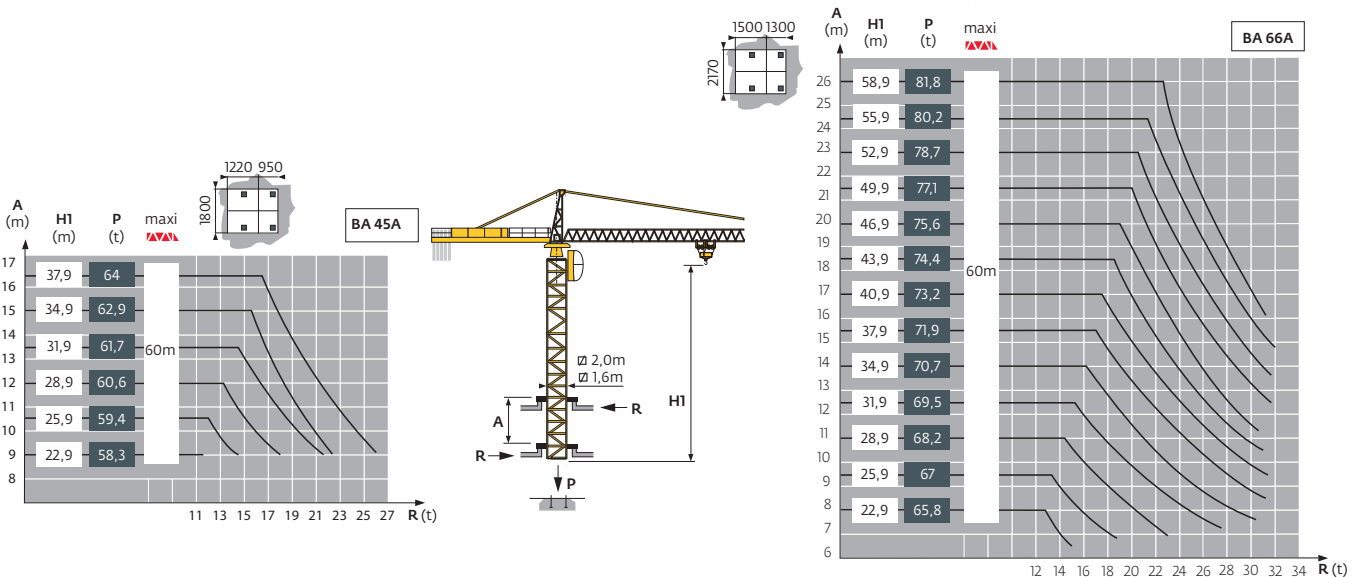

Ancrages / Verankerungen / Anchorages / Anclajes / Ancoraggi
 Ancoragem / Анкера

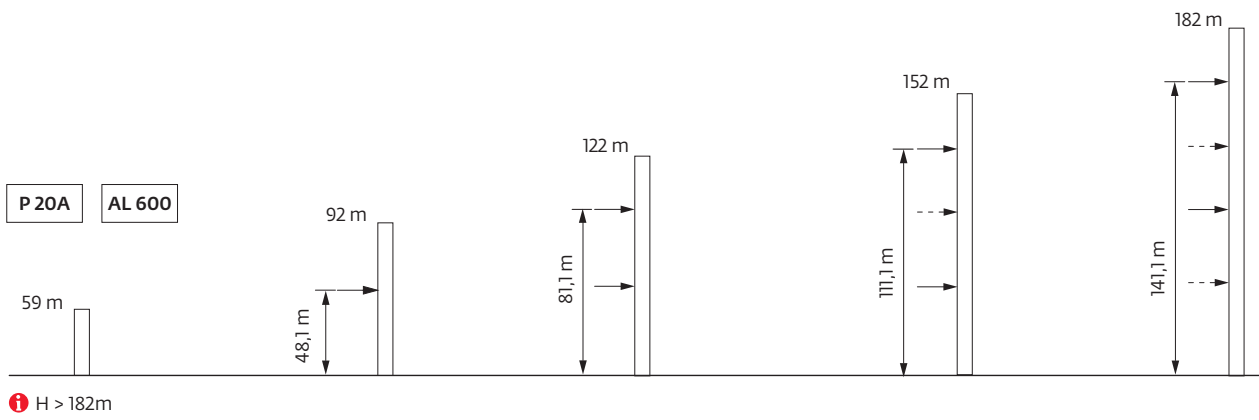
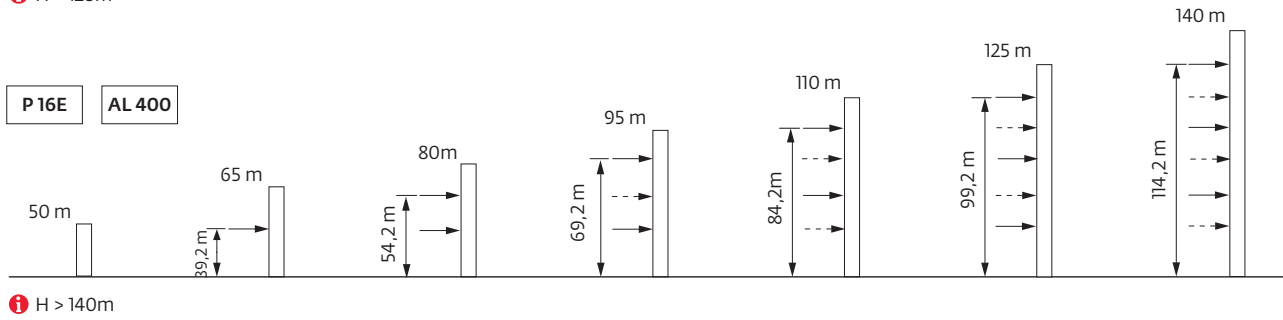
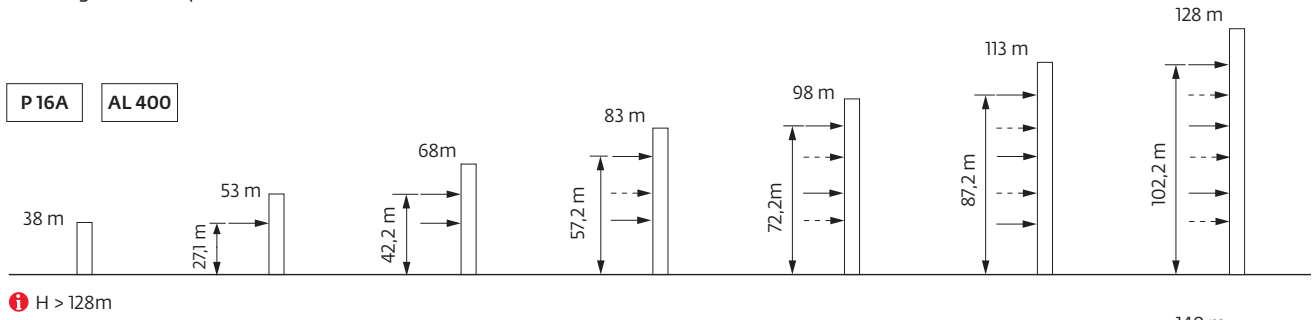

Courbes de charges / Lastkurven / Load curves / Curvas deargas / Curve di carico
 Curvas de carga / Кривые нагрузок





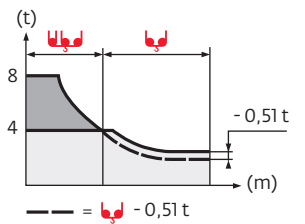



60 m	3,1	▶	14,4	15	17	20	22	25,3	27,5	30	32	35	37	40	42	45	47	50	52	55	57	60	m
▲▼▲▼	8	7,6	6,6	5,4	4,8	4	4	3,6	3,3	3	2,8	2,55	2,4	2,2	2,1	1,9	1,8	1,7	1,6	1,5			t
55 m	3,1	▶	16,3	17	20	22	25	27	28,7	31,2	35	37	40	42	45	47	50	52	55				m
▲▼▲▼	8	7,6	6,3	5,6	4,8	4,3	4	4	3,5	3,3	3	2,8	2,6	2,45	2,25	2,15	2						t
50 m	3,1	▶	19,3	20	22	25	27	30	32	34	34,1	37	40	42	45	47	50						m
▲▼▲▼	8	7,7	6,8	5,9	5,3	4,7	4,3	4	4	4	3,7	3,5	3,2	3	2,8								t
45 m	3,1	▶	20,9	22	25	27	30	32	35	37	40,1	42	45										m
▲▼▲▼	8	7,5	6,5	5,9	5,2	4,8	4,3	4	4	3,8	3,5												t
40 m	3,1	▶	20,8	22	25	27	30	32	35	36,8	40												m
▲▼▲▼	8	7,5	6,4	5,9	5,2	4,8	4,3	4	4														t
35 m	3,1	▶	20,9	22	25	27	30	32	35														m
▲▼▲▼	8	7,5	6,5	5,9	5,2	4,8	4,3																t
30 m	3,1	▶	20,9	22	25	27	30																m
▲▼▲▼	8	7,5	6,5	5,9	5,2																		t
25 m	3,1	▶	21,5	22	25																		m
▲▼▲▼	8	7,8	6,7																				t



Lest de base / Grundballast / Base ballast / Lastre de base / Zavorra di base
 Lastro da base / Базовый Балласт

1,6 m	SB 16A	H (m)	38,9	35,9	32,9	29,9	26,9	23,9	20,9	17,9								
			66	60	60	54	54	54	54	54								
2 m	VB 20A	H (m)	64,1	61,1	58,1	55,1	52,1	49,1	46,1	43,1	40,1	37,1	34,1	31,1	28,1	25,1	22,1	19,1
			132	120	108	84	72	60	48	36	36	36	36	36	36	36	36	36

Poids de flèche & lest de contre-flèche / Auslegergewicht & Gegenauslegerballast / Jib weight & counter-jib ballast / Peso de flecha y lastre de contra-flecha / Peso del braccio & zavorra di contro-braccio / Peso da lança & lastro da contra lança
 Вес стрелы и балласт контр-стрелы

			50 LVF / 60 LVF 		
			3450 kg	2250 kg	 (kg)
60 m	9315	9705	4	2	18 300
55 m	9055	9445	3	3	17 100
50 m	8305	8695	3	2	14 850
45 m	8045	8435	5	1	19 500
40 m	7730	8120	4	2	18 300
35 m	7335	7725	3	3	17 100
30 m	6815	7205	3	2	14 850
25 m	6240	6630	3	2	12 600

CD - 3450 kg

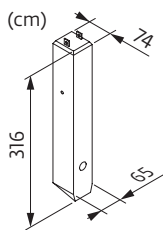

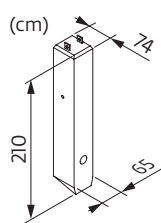

CE - 2250 kg











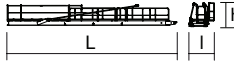

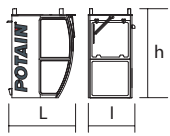
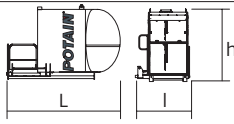
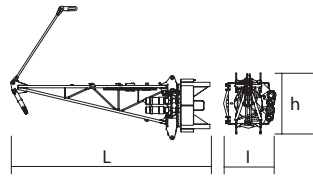
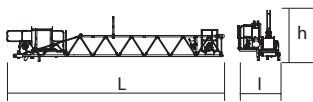
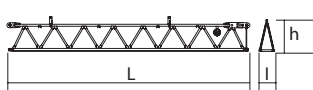
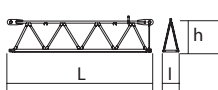
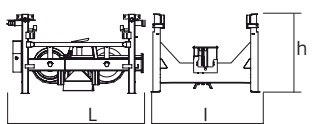
Encombrement et poids / Abmessungen und Gewicht / Dimensions and weight / Dimensiones y peso / Ingombro e peso
dimensões e pesos / габаритные размеры и вес

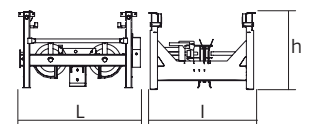
Partie tournante / Drehender Kranteil / Slewing crane part / Parte giratoria

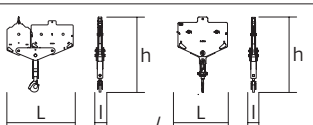





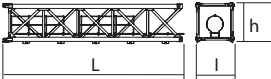
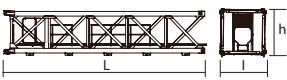
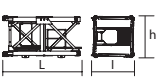
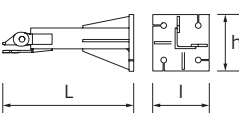
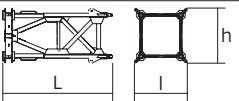
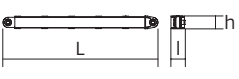
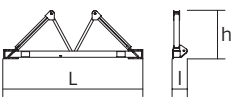

Parte rotante / Parte rotativa / Поворотная часть :  60 m -  50LVF / 60LVF













Partie tournante / Drehender Kranteil / Slewing crane part Parte giratoria / Parte rotante / Parte rotativa Поворотная часть	L (m)	l (m)	h (m)	kg (+/- 5%)		
Contre-flèche / Gegenausleger Counter-jib / Contra-flecha Controbraccio / Contra-lança Контр-стрела		11,94	1,02	0,46	1610	
		3,43	1,02	0,34	530	
Cabine / Kabine Cab / Cabina Cabina / Cabina Кабина		Smartview	1,68	1,18	2,31	385
Cabine / Kabine Cab / Cabina Cabina / Cabina Кабина		V140S	3,4	1,9	2,57	1130
Porte-flèche / Auslegerträger Cathead / Porta-flecha Cuspide / Suporte de lança Оголовок		6,64	2,2	1,68	5530	
Elément de flèche / Auslegerement Jib section / Elemento de flecha Elemento di braccio / Elemento de lança Секция стрелы		① 60 LVF 50 LVF	10,2 10,2	2,05 2,05	1,17 1,17	3900 3410
Elément de flèche / Auslegerement Jib section / Elemento de flecha Elemento di braccio / Elemento de lança Секция стрелы		③ ④	10,2	1,05	1,42	1325
Elément de flèche / Auslegerement Jib section / Elemento de flecha Elemento di braccio / Elemento de lança Секция стрелы		② ⑤ ⑥ ⑦ ⑧ ⑨	5,14 5,18 5,18 5,18 5,18 5,18	1,05 1,05 1,05 1,05 1,05 1,05	1,42 1,17 1,17 1,17 1,17 1,17	750 520 395 315 260 260
Chariot / Laufkatze Trolley / Carrello Carro / Carro-distribuidor Тележка		 8 t  4 t	1,42	1,3	0,96	240
Chariot / Laufkatze Trolley / Carrello Carro / Carro-distribuidor Тележка		 8 t	1,48	1,3	0,96	235
Moufle / Hubflasche Pulley block / Aparejo Bozzello / Cadernal Полиспаст		 8 t  4 t	1,26 0,78	0,2	1,52 1,29	270 115









Equipement de télescope / Teleskopierausrüstung / Telescoping equipment Equipo de telescopaje / Equipaggiamento di telescopaggio / Equipamento de telescopagem Оборудование для телескопирования			L (m)	l (m)	h (m)	kg (+/- 5%)
Cage de télescope / Teleskopwagen Telescopic cage / Jaula de telescopaje Gabbia di telescopaggio / Gaiola de telescopagem для телескопирования крана		□1,6m	6,8	3,65	3,6	3610
		□2m	8,6	4,44	4,36	6205
Mât / Mastwerk / Masts Mástil / Torre / Coluna Мачты						
S 46 J SR 48 JR		□1,6m	7,8	1,8	1,7	2630
		□1,6m	7,8	1,7	1,7	3186
S 68 J		□2 m	7,74	2,1	2,1	4170
L 46 A3 L 66 A3 L 68 B3		□1,6m	3,24	1,67	1,73	1180
		□2 m	3,26	2,12	2,12	1410
		□2 m	3,26	2,12	2,12	1530
Bases / Kranbasen / Crane bases Bases / Basi / Bases фундамент под кран						
Pieds de scellement / VerankerungsfüÙe Fixing angles / Pie de empotramiento Montante da annegare / Angulos fixadores анкера		P 16 A	0,49	0,49	1,14	185
		R 16 A	0,5	0,5	0,69	145
		P 16 E	1,31	0,8	0,8	500
		R 16 E	0,8	0,6	0,6	200
		P 20 A	1,4	0,6	0,6	300
		R 20 A	0,81	0,6	0,6	225
Mât-châssis / Grundmasteinheit Basic mast unit / Tramo-chasis Elemento base / Tramo-chassis Мачта для крепления к шасси		SB 16 A	3,61	1,96	1,96	2645
		VB 20A	5,07	2,39	2,39	4360
Haubans / Mastabstützungen Struts / Tornapuntas Puntoni / Escoras Растяжка		SB 16 A	3,18	0,25	0,24	230
		VB 20A	4,51	0,26	0,27	390
Sommier / Unterwagenhälfte Half-bearer / Testero Testata / Estrutura base Траверса		SB 16 A	5,08	0,61	1,79	1115
		VB 20A	6,7	0,7	2,31	1600









Mécanismes / Triebwerke / Mechanisms / Mecanismos / Meccanismi
Mecanismos / Механизмы



400 V - 50 Hz													hp	kW	
	60 LVF 20	m/min	5	15	47	70,5	94	2,5	7,5	23,5	35,3	47	60	45	445 m
		t	4	4	4	3	2	8	8	8	6	4			
	5 D3 V4	m/min	15 - 30 - 58										5	3,7	
	RCV 145	rpm	0 → 0,8										2 x 6	2 x 4,4	
															

400 V - 50 Hz													hp	kW			
	50 LVF 20 Optima	m/min	3,8	14,8	46	58	84	112	1,9	7,4	23	29	42	56	50	37	363 m
		t	4	4	4	3	2	1	8	8	8	6	4	2			
	7 DVF 4	m/min	0 → 76										6,5	4,8			
	RCV 145	rpm	0 → 0,8										2 x 6	2 x 4,4			
																	

 IEC 60204-32	 kVA
400 V (+10% -10%) 50 Hz	60 LVF : 62 kVA 50 LVF : 54 kVA

480 V - 60 Hz													hp	kW	
	60 LVF 20	m/min	5	15	47	70,5	94	2,5	7,5	23,5	35,3	47	60	45	445 m
		t	4	4	4	3	2	8	8	8	6	4			
	5 D3 V4	m/min	18 - 36 - 70										6	4,4	
	RCV 145	rpm	0 → 0,96										2 x 7,2	2 x 5,3	
															

480 V - 60 Hz													hp	kW			
	50 LVF 20 Optima	m/min	3,8	14,8	46	58	84	112	1,9	7,4	23	29	42	56	50	37	363 m
		t	4	4	4	3	2	1	8	8	8	6	4	2			
	7 DVF 4	m/min	0 → 76										6,5	4,8			
	RCV 145	rpm	0 → 0,96										2 x 7,2	2 x 5,3			
																	

 IEC 60204-32	 kVA
480 V (+6% -10%) 60 Hz	60 LVF : 64 kVA 50 LVF : 56 kVA

50 LVF 20 Optima

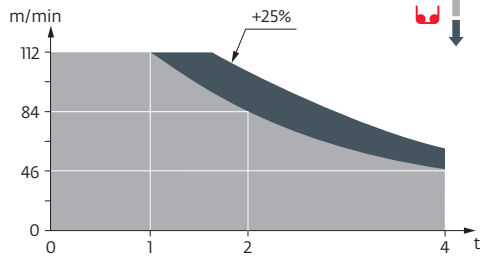

60 LVF 20

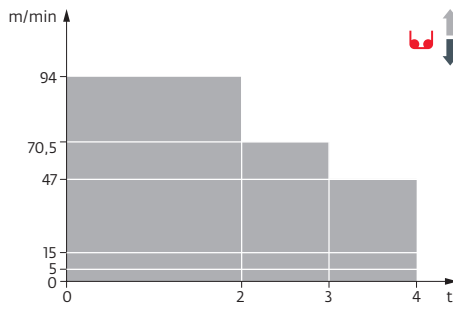

	FR	DE	EN	ES	IT	PT	RU
	Appel de flèche	Auslegerüberhöhung	Jib elevation	Elevación de la flecha	Inclinazione braccio	Desvio da lança	подъем стрелы
	Réactions en service	Reaktionskräfte in Betrieb	Reactions in service	Reacciones en servicio	Reazioni in servizio	Reacções em serviço	Реакция при работе
	Réactions hors service	Reaktionskräfte außer Betrieb	Reactions out of service	Reacciones fuera de servicio	Reazioni fuori servizio	Reacções fora de serviço	Реакция в покое
	A vide sans lest avec flèche et hauteur maximum	Gewicht ohne Last, ohne Ballast, mit Ausleger und max. Höhe	Weight without load, without ballast, with jib and max. height	Peso en vacío sin lastre, con flecha y altura máxima	Peso a vuoto, senza zavorra, con braccio e altezza massimi.	Peso em vazio sem lastro com lança e altura máxima.	Вес пустого, без балласта, со стрелой, максимальной высоты.
	Poids total du lest	Ballast-Gesamtgewicht	Total ballast weight	Peso total del lastre	Peso totale della zavorra	Peso total do lastro	Общий вес балласта
	Camion 13,4 m	Lkw 13,4 m	Lorry 13,4 m	Camión 13,4 m	Camion 13,4 m	Camião 13,4 m	Ррузовой автомобиль 13,4 м
	Conteneur High Cube 40"	Container High Cube 40"	Container High Cube 40"	Contenedor High cube 40"	Container High Cube 40"	Contentor 40"	Контейнер повышенной вместимости длиной 40"
	Cadre d'ancrage serré	Fester Verankerungsrahmen	Tightened anchorage frame	Marco de anclaje de apriete	Quadro di ancoraggio stretto	Quadro de amarração apertado	Прикрепленная анкерная рама
	Cadre d'ancrage desserré	Losser Verankerungsrahmen	Loosened anchorage frame	Marco de anclaje de desapriete	Quadro di ancoraggio allentato	Quadro de amarração solto	Отсоединенная анкерная рама
	Levage	Heben	Hoisting	Elevación	Sollevamento	Elevação	Подъем
	Distribution	Katzfahren	Trolleying	Distribución	Distribuzione	Distribuição	Перемещение по стреле
	Orientation	Schwenken	Slewing	Orientación	Rotazione	Rotação	Поворот
	Translation	Kranfahren	Travelling	Traslación	Traslazione	Translação	Перемещение крана
	Puissance nominale	Nennleistung	Rated power	Potencia nominal	Potenza nominale	Potência nominal	Номинальная мощность
	Voir télescopage sur dalles	Siehe Kletterkrane im Gebäude	See climbing crane	Veja grua trepadora	Consultare gru in cavedio	Ver telescopagem sobre lages	См. кран, ползущий внутри здания
	Nous consulter	Auf Anfrage	Consult us	Consultarnos	Consultateci	Consultar-nos	Проконсультируйтесь у нас
	Document commercial non contractuel. Pour toute information technique se référer à la notice correspondante.	Unverbindliches Vertriebsdokument. Für technische Informationen, siehe die entsprechenden Anweisungen.	This commercial document is not legally binding. For any technical information, please refer to the corresponding instructions.	Documento comercial no contractual. Para cualquier información técnica, ver la noticia correspondiente.	Documento commerciale non vincolante, per tutte le informazioni tecniche fare riferimento al catalogo Istruzioni.	Documento comercial não contractual. Para qualquer informação técnica complementar consultar as respectivas instruções.	Этот коммерческий документ не является юридически обязательным. Для получения технической информации, см. соответствующие инструкции.

