

Manitowoc 10000E-1

Product Guide

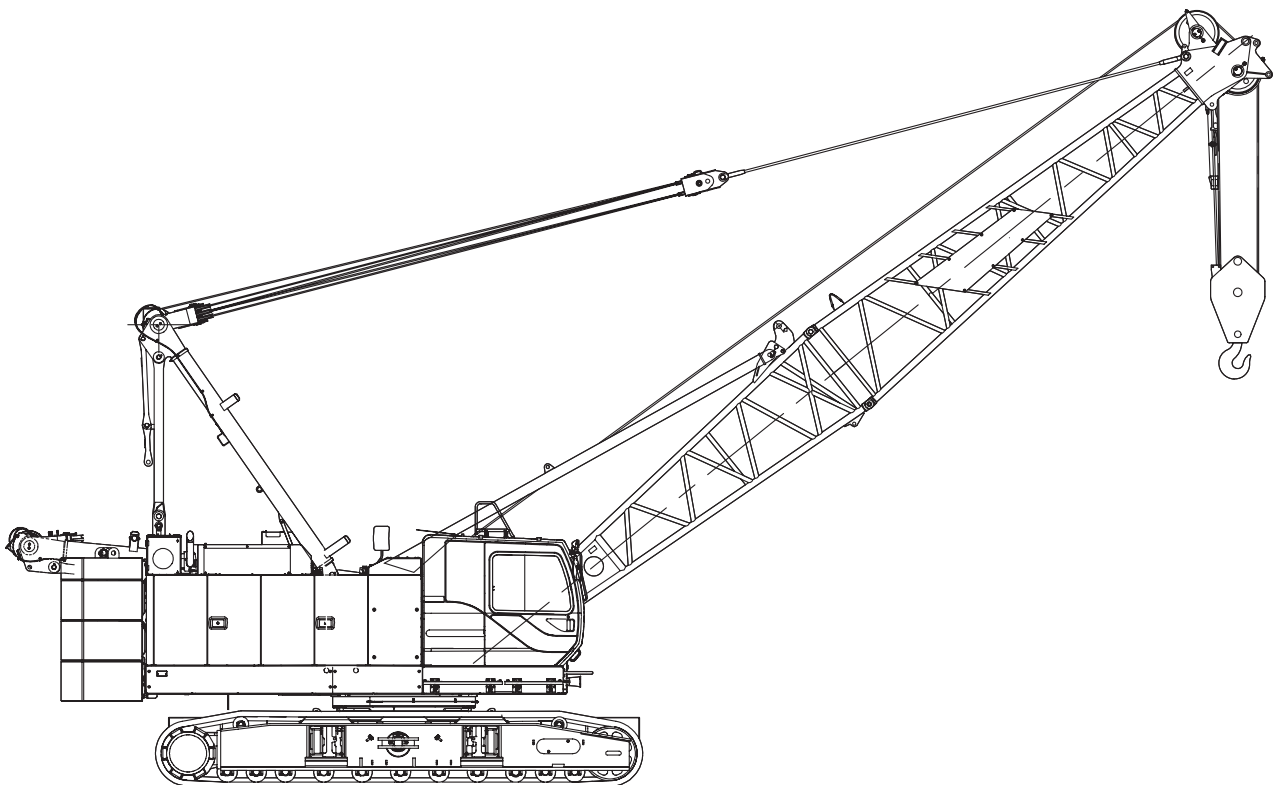

Features

- 90 t capacity
- 61,0 m heavy-lift boom
- Max boom + jib combination:
51,8 m + 18,3 m
- 213 kW engine
- 160 m/min maximum line speed
- 112 kN rated line pull

Contents

Specifications	4
Outline dimensions	7
Winch performance data	13
Load chart notes	14
Boom combinations	15
Heavy-lift boom range / charts	16
Fixed jib boom range / load charts	18
Clamshell	21
Manitowoc Crane Care	22

Specifications

Upperworks



Engine

Hino J08E-UV, 6 cylinder, water-cooled diesel, direct fuel injection with turbocharger, 213 kW at 2100 high-idle RPM. Maximum torque 1017 N•m net at 1,600 rpm.

Emission standard: Interim Tier 4/Stage IIIB.

One diesel fuel tank, 400 liters capacity.

Two 12 volt 136 AH capacity batteries, 24 volt system and 90 amp alternator.

All wiring harnesses and connectors are numbered for easier servicing. Machine is equipped with individual fused branch circuits.

Relief valve pressures:

Load hoist, boom hoist, propel system. 31.9 MPa

Swing system: 27.5 MPa

Control system: 7.0 MPa



Controls

Full-flow hydraulic control system for constant variable pressure to front and rear drums, boom hoist brakes and clutches. Controls respond instantly to the touch, delivering smooth function operation.



Hydraulic system

All three variable displacement piston-type pumps are driven by a heavy-duty pump drive. One of these pumps is used in the left propel circuit and hook hoist circuit, and can accommodate an optional third circuit. Another is used in the right propel circuit, boom hoist circuit and hook hoist circuit. The third variable displacement pump is used in the swing circuit. In addition, two gear pumps are used in the control system and auxiliary equipment, and two gear pumps serve the brake cooling system.

Maximum pressure rating: 31.9 MPa

Load hoist, boom hoist and propel: 2 Piston pumps

Swing 1 Piston pump

Control system and auxiliary: 2 Gear pumps

Brake cooling system 2 Gear pumps

Reservoir capacity: 440 liter

Cooling: oil-to-air heat exchanger

Filtration: full-flow and bypass type with replaceable paper elements.



Drums

Front and rear drums for load hoist powered by variable displacement piston-type motors, driven through planetary reducers. Powered hoisting/lowering and free-fall operation is standard. Drum turn indicators for front and rear drums are optional.

Drums: (front and rear) 614 mm P.C.D. x 617 mm wide drums, grooved for 26.0 mm wire rope.

Brakes: Counterbalance valve and spring set hydraulically released multiple disk brake mounted on hoist motor. External ratchet is fitted for locking drum.

Wire rope capacity:

Front drum 240 m working length

Rear drum 165 m working length

Line speed: Single line on the first drum layer

Hoisting: 120m/min

Lowering: 120m/min

➤ **Optional third drum:** grooved for 22 mm wire rope; free-fall is optional.

Wire rope working length 145m.



Swing system

Swing unit: Powered by a hydraulic piston-type motor driving spur gears through planetary reducers, the swing system provides 360° rotation.

Swing brake: A spring-set, hydraulically released multiple-disc brake is mounted on swing motor.

Swing lock: 4-Position lock for transportation.

Rotating bed turntable: Single-row ball bearing with an integral internally cut swing gear.

Swing speed: 4.0 rpm



Boom support system

Single drum powered by a hydraulic axial piston motor through a planetary reducer.

Brake: A spring-set, hydraulically released multiple-disc brake is mounted on the boom hoist motor. An external ratchet is fitted for locking the drum.

Drum: Single drum, grooved for 16 mm diameter wire rope. Boom hoist reeving is 12-part line.

Wire Rope Capacity:

Drum 150 m working length.

Line speed: Single line on first drum layer.

Hoisting 70m/min

Lowering 70m/min

Specifications



Gantry

This high folding type gantry is fitted with a sheave frame for boom hoist reeving. It provides full up, full down positions.



Counterweight

Upper weight (5 pieces): 31,900 kg
Carbody weight (2 pieces): 14,400 kg



Operator's cab

Totally enclosed, full vision cab fitted with tinted safety glass and opening front window. A fully adjustable, highbacked seat with arm rests. Short handle control levers; electronic twist grip hand throttle. Joystick controls are optional. An air conditioner, a signal horn and windshield wiper are standard.

Lights:

- 2 - Front flood lights
- 1 - Cab inside light

Safety device

- New, easy to read at a glance, LMI and maintenance display
- Function lock lever
- Boom over hoist limit
- Signal horn
- Front and rear hoist drum lock
- Swing alarm
- Auto return control levers
- Fire extinguisher
- External lamp for overload alarm
- Anti two-block
- Boom angle indicator
- Boom hoist drum lock
- Swing lock
- Boom backstops
- 1-2 drum select switch
- Cab top guard
- Rope over-payout prevention device

Lowerworks



Carbody

The durable carbody features steel welded construction with extendible axles.



Crawlers

Crawler assemblies can be hydraulically extended for wide-track operation or retracted for transportation.

Crawler belt tension adjusted with hydraulic jack and maintained by shims between idler block and frame.

The independent hydraulic propel drive is built into each crawler side frame. Each drive consists of a hydraulic motor propelling a driving tumbler through a planetary gearbox. Hydraulic motor and gear box are built into the crawler side frame within the shoe width. The track rollers are sealed for maintenance-free operation.

Crawler brakes: multiple disk type, spring set hydraulically released parking brakes are built into each propel drive.

Crawler shoes

800 mm wide crawler.

Travel speed

(High/Low) 1.73/1.2 km/h

Attachments



Boom

Welded lattice construction using tubular, high-tensile steel chords with pin connections between sections.

Two idler sheaves and three point sheaves are standard.

Basic boom length 12,2 m. Basic boom consists of the boom butt 5,8 m and boom top 6,39 m.

Optional boom inserts are welded lattice construction with tubular, high-tensile steel chords and pin connections on each one of 3,0 m, 6,1 m and 12,2 m inserts.

Maximum total length of boom 61,0 m.



Fixed jib

The optional fixed jib employs welded lattice construction with tubular, high-tensile steel chords with pin connections between sections.

Basic jib length 9,14 m. Basic jib length consists of jib butt section 4,57 m and jib top 4,57 m.

Optional jib boom inserts of 3,0 m, 6,1 m are available for extension capabilities up to 18,3 m.

Maximum total length of boom and jib 51,8 m + 18,3 m is 70,1 m.

Specifications

Tool and accessories

A set of tools and accessories are furnished.

Optional Equipment

- ▶ Optional: Blocks and hooks each with roller bearing sheaves grooved for 26.0 mm diameter wire rope, and roller bearing swivel with hook latch.
- ▶ 11,0 t ball hook, 460 kg, for 26 mm wire rope.
- ▶ 35 t hook block, 700 kg with one 617 mm Nominal O.D. roller bearing sheave.
- ▶ 70 t hook block, 900 kg, three 617 mm Nominal O.D. roller bearing bearing sheaves.
- ▶ 90 t hook block, 1 300 kg, with four 617 mm Nominal O.D. roller bearing sheaves.
- ▶ Optional: Detachable upper boom point with one 575 mm Nominal outer diameter roller bearing steel sheave grooved for 26mm rope for liftcrane.
- ▶ Machine inclination sensor.
- ▶ Swing angle detection and angle limiter.
- ▶ Handrail for upper guard.
- ▶ Anti-dust netting.

Working weight

Approximately 90,100 kg including upperworks and lowerworks, full upper counterweights, full carbody counterweights, 12,2 m basic boom and 90 t hook block.

Ground pressure

Approximately 101 kPa with basic boom and no load.

Gradeability

With basic boom: 40%.

Outline dimensions

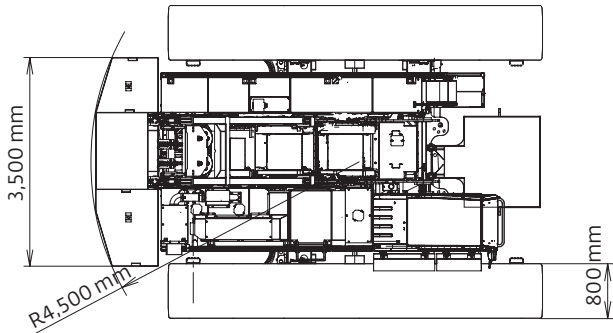
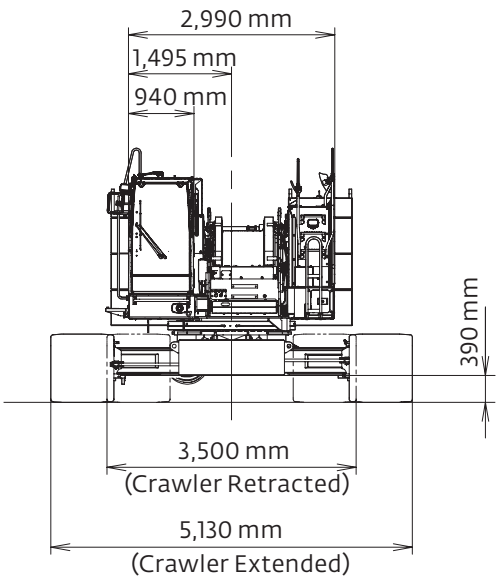
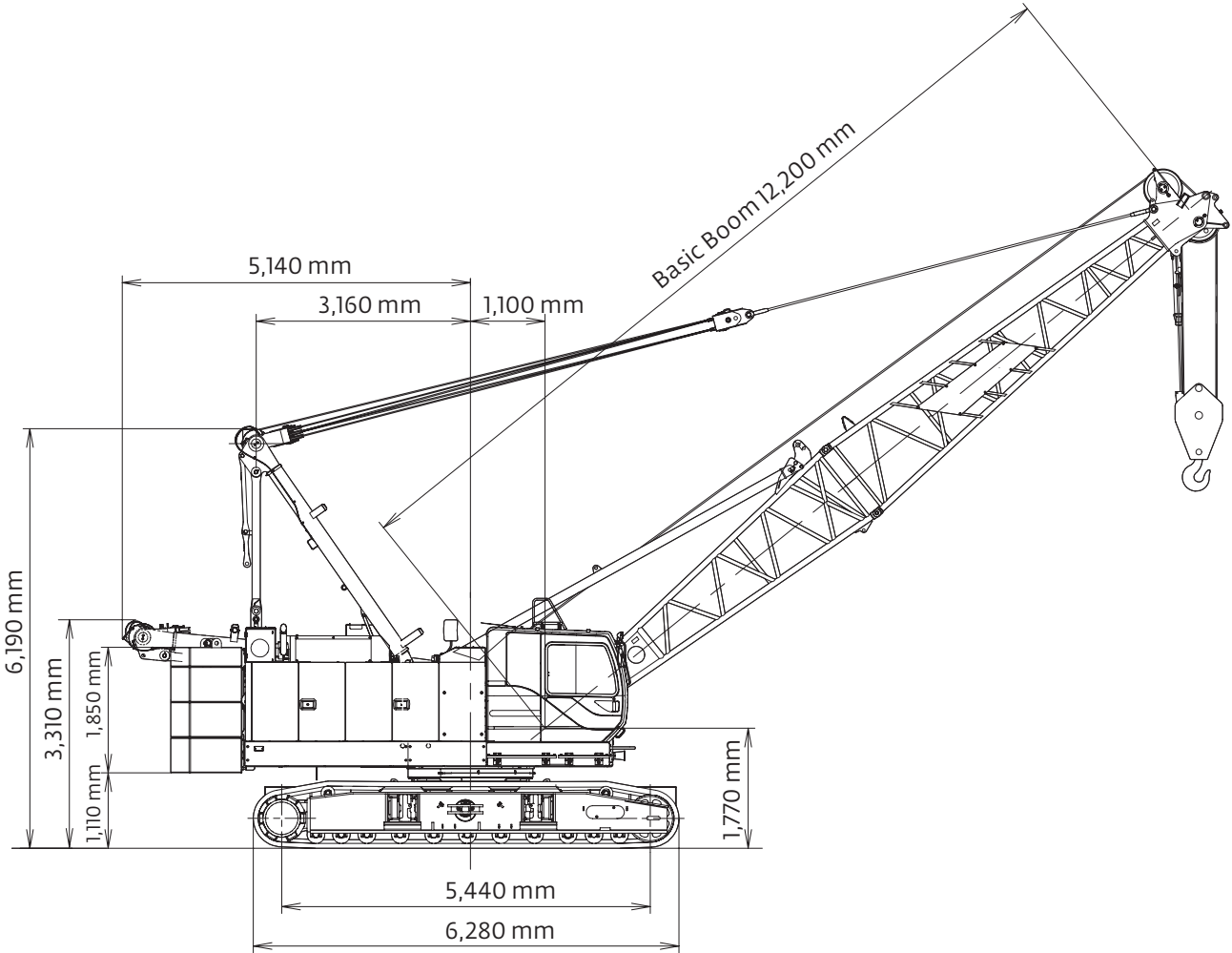

Outline dimensions

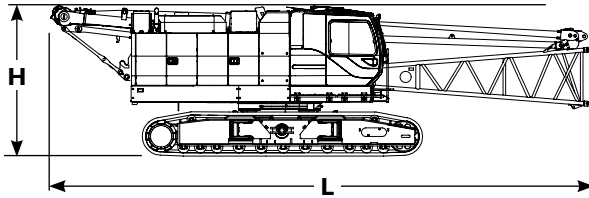

Upperworks x 1

Length	12,09 m
Width	3,50 m
Height	3,32 m
Weight	41 360 kg

Note: Weight includes base machine, crawler, gantry, maximum hoist and whip lines on drums, boom butt, full hydraulic fluid reservoir, and one third tank of fuel.

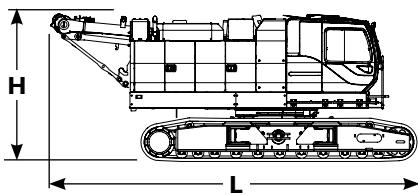

Upperworks x 1

Length	8,21 m
Width	3,55 m
Height	3,32 m
Weight	39 300 kg

Note: Weight includes base machine, crawler, gantry, maximum hoist and whip lines on drums, full hydraulic fluid reservoir, and one third tank of fuel.

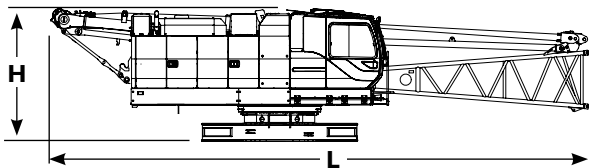

Upperworks without crawlers x 1

Length	12,09 m
Width	2,99 m
Height	2,92 m
Weight	27 000 kg

Note: Weight includes base machine, gantry, maximum hoist and whip lines on drums, boom butt, full hydraulic fluid reservoir, and one third tank of fuel.

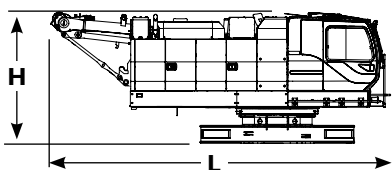

Upperworks without crawlers x 1

Length	7,70 m
Width	2,99 m
Height	2,87 m
Weight	24 940 kg

Note: Weight includes base machine, gantry, maximum hoist and whip lines on drums, full hydraulic fluid reservoir, and one third tank of fuel.

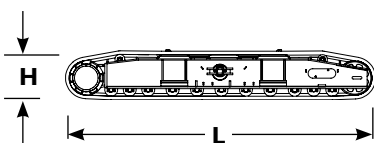

Crawlers x 2

Length	6,28 m
Width	1,04 m
Height	0,98 m
Weight	7 180 kg

Option

Outline dimensions

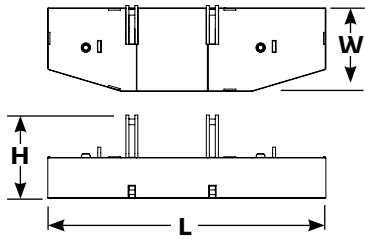

Upper counterweight No. 1 x 1

Length	3,50 m
Width	1,08 m
Height	1,05 m
Weight	10 540 kg

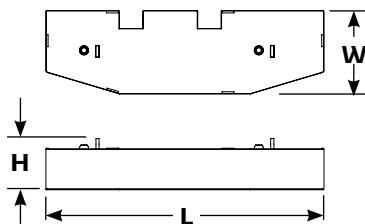

Upper counterweight No. 2 x 1

Length	3,50 m
Width	1,05 m
Height	0,65 m
Weight	9 930 kg

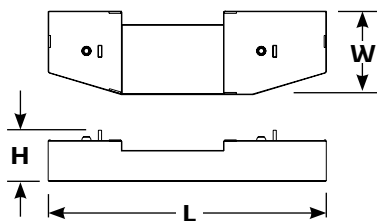

Upper counterweight No. 3 x 1

Length	3,50 m
Width	1,05 m
Height	0,64 m
Weight	8 250 kg

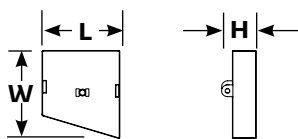

Upper counterweight No. 4 (L) x 2

Length	0,93 m
Width	1,05 m
Height	0,41 m
Weight	1 280 kg

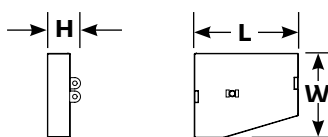

Upper counterweight No. 4 (R) x 2

Length	1,30 m
Width	1,05 m
Height	0,41 m
Weight	1 900 kg

► Option

Outline dimensions

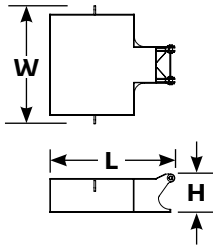

Carbody counterweight x 2

Length	1,90 m
Width	1,79 m
Height	0,59 m
Weight	7 200 kg

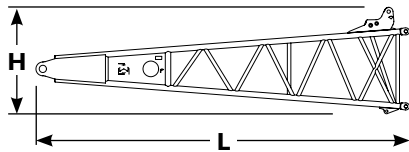

Boom butt x 1

Length	5,97 m
Width	1,49 m
Height	1,70 m
Weight	1 120 kg

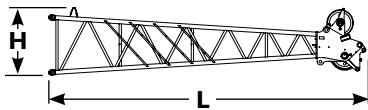

Boom top x 1

Length	6,91 m
Width	1,51 m
Height	1,48 m
Weight	1 220 kg

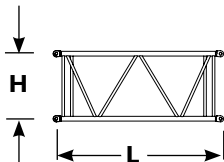

Boom insert 3,0 m x 1,2

Length	3,16 m
Width	1,49 m
Height	1,32 m
Weight	300 kg

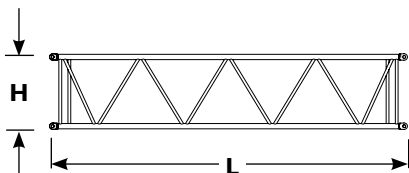

Boom insert 6,10 m x 1,2

Length	6,21 m
Width	1,49 m
Height	1,32 m
Weight	510 kg

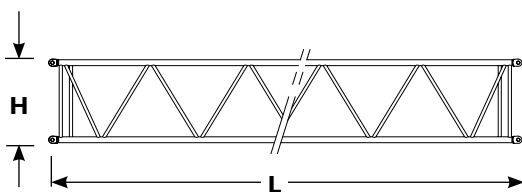

Boom insert 12,2 m x 1,2,3

Length	12,31 m
Width	1,49 m
Height	1,32 m
Weight	950 kg

Note: Use one "A" type insert with lug required for any boom combinations that require a 12,2 m insert.

Option

Outline dimensions

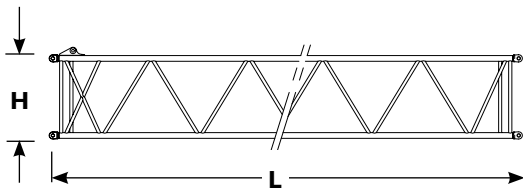

Boom insert with lug 12,2 m	x 1
Length	12,31 m
Width	1,49 m
Height	1,32 m
Weight	1 220 kg

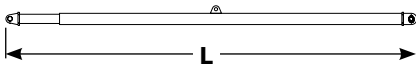

Backstop	x 1,2
Length	5,13 m
Weight	270 kg

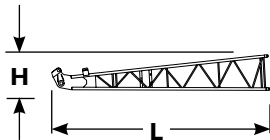

Fixed jib butt	x 1
Length	4,81 m
Width	0,80 m
Height	0,80 m
Weight	200 kg

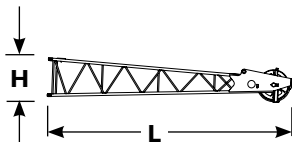

Fixed jib top	x 1
Length	5,00 m
Width	0,80 m
Height	0,80 m
Weight	180 kg

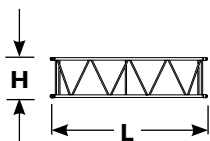

Fixed jib insert 3,0	x 1
Length	3,11 m
Width	0,80 m
Height	0,80 m
Weight	100 kg

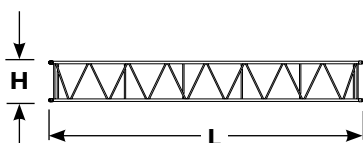

Fixed jib insert 6,1 m	x 1
Length	6,16 m
Width	0,80 m
Height	0,80 m
Weight	180 kg

▶ Option

Outline dimensions

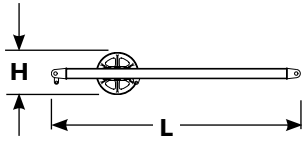

Fixed jib strut	x 1
Length	3,62 m
Width	0,84 m
Height	0,62 m
Weight	250 kg

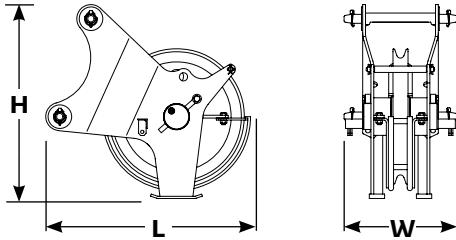

Auxiliary sheave (upper boom point)	x 1
Length	0,87 m
Width	0,48 m
Height	1,10 m
Weight	195 kg

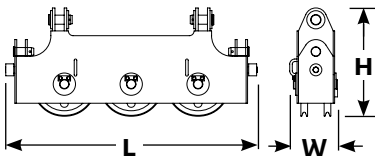

Upper spreader	x 1
Length	1,58 m
Width	0,30 m
Height	0,68 m
Weight	280 kg

Option

Winch performance data

Line pull

	Rated line pull kg	*Maximum line pull kg
Front drum	11 420	21,200
Rear drum	11 420	21,200
Optional 3rd drum	7 700	15,600

* Maximum line pull is not based on wire rope strength.

Wire rope specifications

Use	Specs	Diameter mm	Working length m	Breaking strength kN
Front drum	U3 x SeS (48)	26,0	240	601
Rear drum	U3 x SeS (48)	26,0	165	601
Boom hoist drum	IWRC 6 X P.ws (31)	16,0	150	210
Optional 3rd drum	IWRC 6 X Fi (29)	22,0	145	363

Front and rear winch

Layer	Single line pull kg	Line speed m/min				
		1	2	3	4	5
Rated line pull	0	125	133	142	151	160
	2 268	124	132	141	150	159
	4 536	108	108	108	108	108
	6 804	72	72	72	72	72
	9 072	54	54	54	54	54
	11 340	43	43	43	43	43
	13 608	36	36	36	38	41
	15 876	32	34	36	38	
	18 144	32	34			

NOTE: Line speeds and line pull based on single line.
Line pulls are not based on wire rope strength.

Load chart notes

1. Rated loads included in the charts are the maximum allowable freely suspended loads at a given boom length, boom angle and load radius, and have been determined for the machine standing level on firm supporting surface under ideal operating conditions. The user must limit or de-rate rated loads to allow for adverse conditions (such as soft or uneven ground, out-of-level conditions, wind side loads, pendulum action, jerking or sudden stopping of loads, inexperience of personnel, multiple machine lifts, and traveling with a load).
2. Ratings are according to EN 13000. Capacities based on factors other than machine stability such as structural competence are shown by asterisk * in the charts located in the operator's crane cab.
3. The machine must be reeved and set-up as stated in the operation manual and all the instruction manuals. If these manuals are missing, obtain replacements. Boom backstops are required for all boom lengths. Gantry must be in the fully raised position for all operations. Crawlers must be fully extended and be locked in position. The crane must be leveled to within 1% on a firm supporting surface.
4. Do not attempt to lift where no radius or load is listed as crane may tip or collapse.
5. Attempting to lift more than rated loads may cause machine to tip or collapse. Do not tip machine to determine capacity.
6. Weight of hooks, hook blocks, slings and other lifting devices are a part of the total load. Their total weight must be subtracted from the rated load to obtain the weight that can be lifted.
7. The total load that can be lifted by the fixed jib is limited by rated jib loads. The total load that can be lifted with the upper boom point is limited by rated upper boom point loads.
8. Boom lengths for fixed jib mounting are 24,4 m to 51,8 m.
9. The upper boom point rated load should not exceed 11 000 kg.
10. An upper boom point cannot be used on a 61 m boom length.
11. The boom should be erected over the front of the crawlers, not laterally. When erecting and lowering the boom with a length of 51,8 m with jib, blocking must be placed at the end of the crawlers. See operator's manual for details.

12. Least stable position is over the side.
13. Maximum hoist load for number of reeving parts of line for hoist rope.

Maximum load for main boom

No. of parts of line	1	2	3	4	5
Maximum loads kg	11 400	22 800	34 200	45 600	57 000

No. of parts of line	6	7	8
Maximum loads kg	68 400	79 400	90 000

Maximum load for fixed jib

No. of parts of line	1
Maximum loads kg	10 900

Maximum load for upper boom point

No. of parts of line	1
Maximum loads kg	11 000

14. Lifting capacities listed apply only to the machine as originally manufactured for and supplied by Manitowoc Cranes, Inc. Modifications to this machine or use of equipment other than that specified can reduce operating capacity.
15. Designed and rated to comply with EN 13000.

Operation of this equipment in excess of rated loads or disregard of instruction voids the warranty.

Boom combinations

No. 10000E-1 heavy-lift boom combinations

Boom length m	Boom inserts		
	3,1m	6,1m	12,2m
12,2	–	–	–
15,2	1	–	–
18,3	2	–	–
21,3	1	1	–
24,4	2	1	–
27,4	1	2	–
30,5	2	2	–
33,5	1	1	1*
36,6	2	1	1*
39,6	1	2	1*
42,7	2	2	1*
45,7	1	1	2*
48,8	2	1	2*
51,8	1	2	2*
54,9	2	2	2
57,9	1	1	3
61,0	2	1	3

* NOTE: One 12,20 m boom insert with lug is required for fixed jib. When no jib is installed a 12,20 m boom without lug can be used instead.

No. 10000E-1 fixed jib combinations

Fixed jib length m	Fixed jib inserts	
	3,1m	6,1m
9,1	–	–
12,2	1	–
15,2	–	1
18,3	1	1

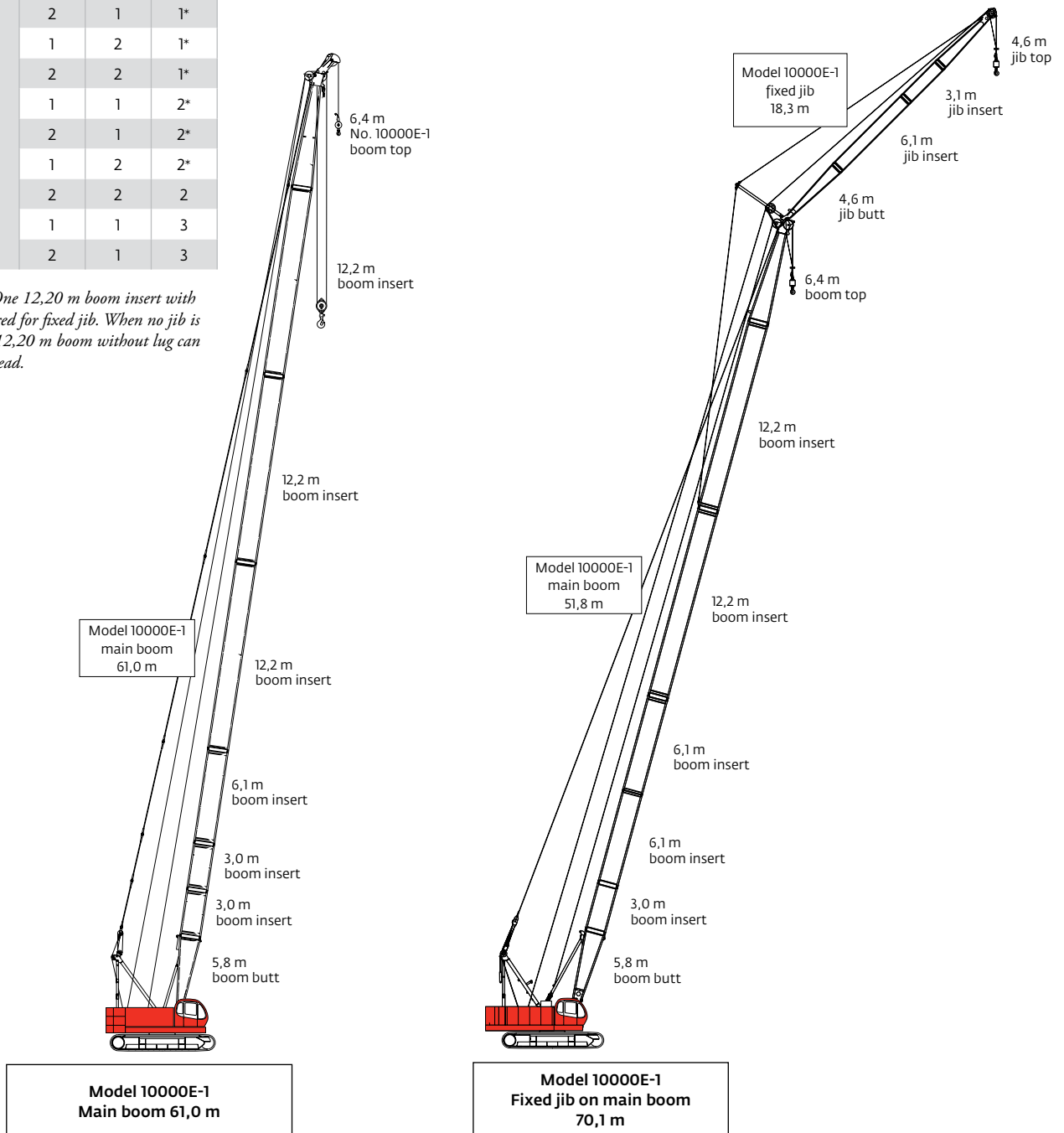

Heavy-lift boom range diagram

No. 10000E-1 main boom

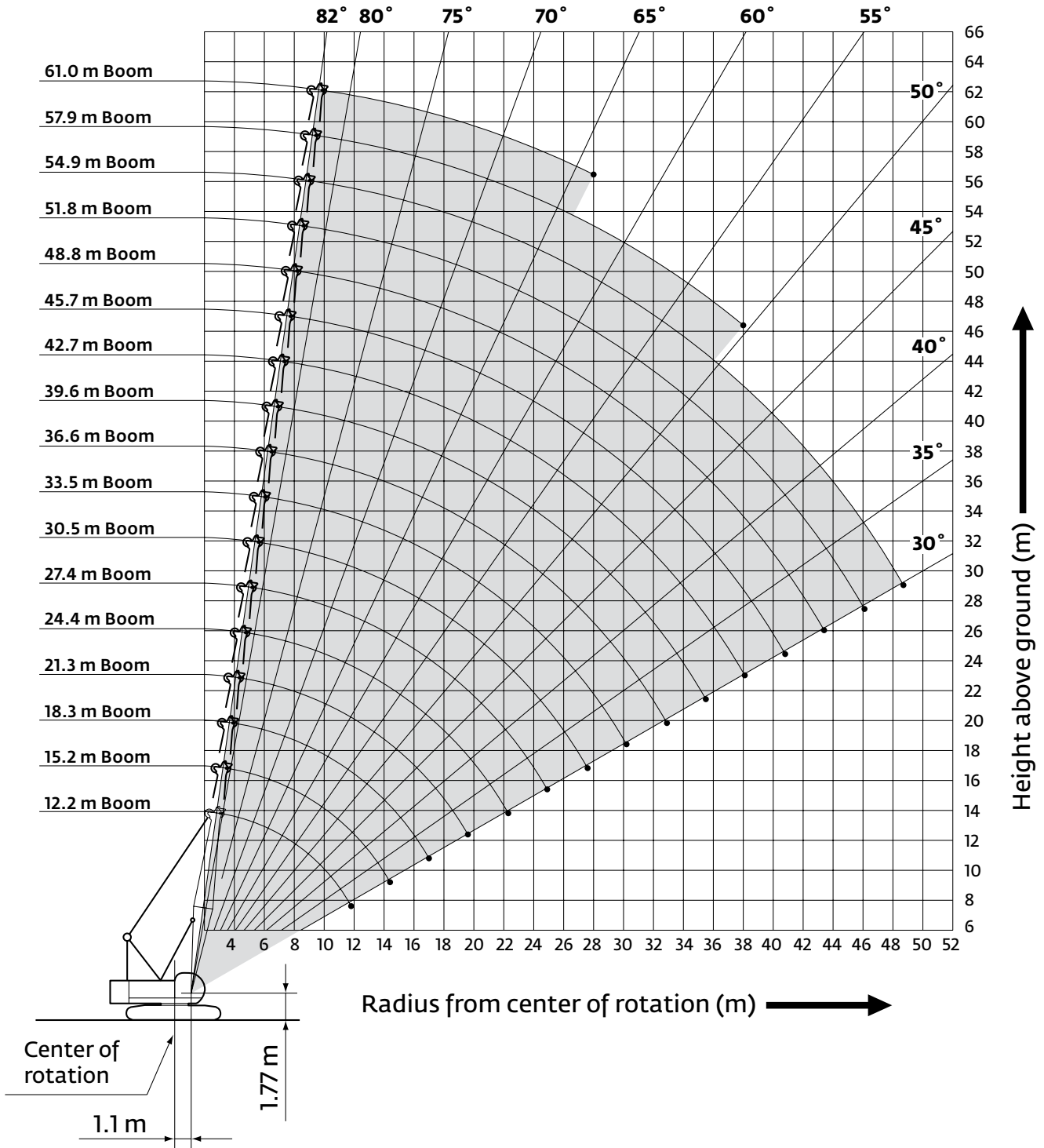

Heavy-lift boom load charts

Model 10000E-1 liftcrane boom capacities - 10000E-1 main boom

31,9 t upper counterweight + 14,4 t carbody counterweight

360° Rating

kg x 1 000

Boom m	12,2	15,2	18,3	21,3	24,4	27,4	30,5	33,5	36,6	39,6	42,7	45,7	48,8	51,8	54,9	57,9	61,0
Radius																	
3,9	90,0*	89,9*	89,7*														
4,0	89,9*	88,9*	88,7*														
4,5	79,6*	79,5*	79,4*	68,4*													
5,0	72,1*	71,9*	71,8*	68,4*	67,6	57,0*											
5,5	65,8*	65,7*	65,5*	63,6	60,6	57,0*	54,0*										
6,0	60,5*	60,3*	59,9	57,5	54,9	52,7	50,5	45,6*									
7,0	48,6	48,5	48,4	48,1	46,2	44,5	42,9	41,5	40,0	34,2*	31,9*						
8,0	39,9	39,8	39,7	39,9	39,8	38,5	37,2	36,9	35,0	33,9	31,4*	27,8*	22,1*				
10,0	29,3	29,2	29,1	29,2	29,1	29,0	28,9	28,5	27,7	27,0	26,2	24,5*	19,5*	17,4*	15,2*	13,4*	11,7*
12,0	22,9*	22,9	22,8	22,9	22,8	22,7	22,6	22,6	22,5	22,3	21,7	21,2	17,3*	15,4*	13,3*	11,7*	10,2*
14,0		18,8	18,6	18,8	18,6	18,5	18,4	18,4	18,3	18,3	18,1	18,0	15,5*	13,8*	11,9*	10,4*	9,0*
16,0			15,7	15,8	15,7	15,6	15,5	15,4	15,3	15,3	15,2	15,1	14,1*	12,4*	10,7*	9,3*	8,0*
22,0					10,5	10,4	10,2	10,2	10,0	10,0	9,9	9,8	9,8	9,6*	8,1*	7,0*	5,9*
28,0								7,4	7,2	7,2	7,0	7,0	6,9	6,8	6,4*	5,4*	4,5*
32,0									6,0	6,0	5,8	5,7	5,7	5,6	5,4	4,6*	3,8*
36,0										5,1	4,8	4,8	4,7	4,6	4,4	4,0*	3,2*
38,0											4,4	4,4	4,2	4,1	4,0	3,6*	2,9*
40,0												4,0	3,9	3,8	3,6	3,3*	2,6*
44,0													3,3	3,1	3,0	2,8*	2,1*
48,0															2,5	2,2*	1,7*
52,0																1,8*	

Meets EN13000 Requirements.

Notice: This capacity chart is for reference only and must not be used for lifting purposes.

For complete chart, refer to www.cranelibrary.com.

Fixed jib range diagram

No. 10000E-1 fixed jib on main boom

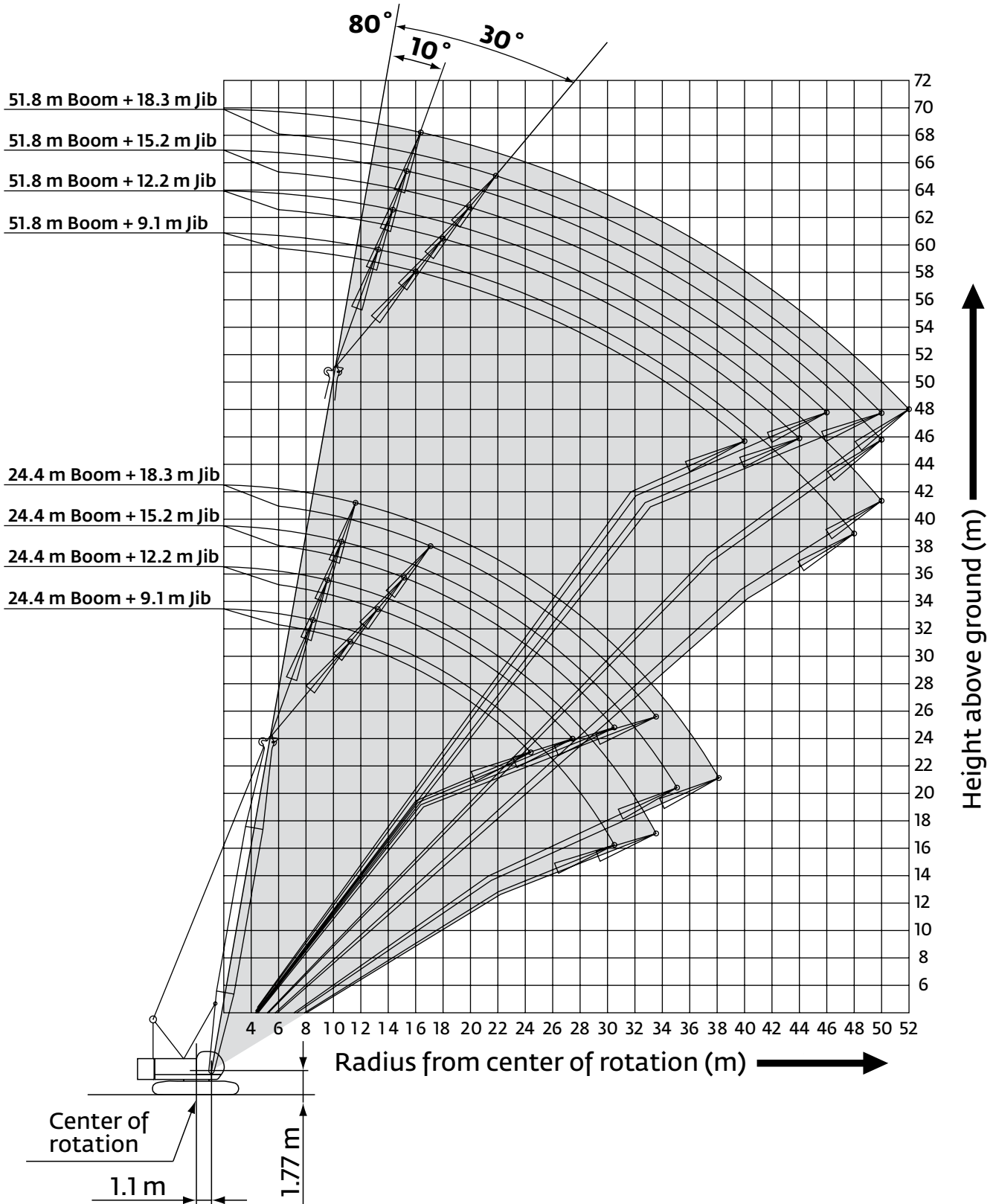

Fixed jib load charts

Model 10000E-1 liftcrane jib capacities No. 10000E-1 fixed jib on main boom

31 900 kg upper counterweight, 14 400 kg carbody counterweight crawler extended

360° Rating

kg x 1 000

10° offset

30° offset

Boom m	24,4	30,5	39,6	48,8	51,8
Radius					
10,0	10,9*				
12,0	10,9*	10,9*	10,9*		
14,0	10,9*	10,9*	10,9*	10,9*	
18,0	10,9*	10,9*	10,9*	10,8*	10,7
24,0	8,0	7,8	7,4	7,2	7,1
30,0	5,9	5,7	5,4	5,1	5,0
36,0			4,0	3,7	3,6
42,0			3,0	2,8	2,7
44,0				2,5*	2,3*
48,0				1,8*	1,7*
52,0					

Boom m	24,4	30,5	39,6	48,8	51,8
Radius					
10,0					
12,0	9,5*				
14,0	9,3*	9,5*			
18,0	8,0*	8,6*	9,2*		9,5*
24,0	6,8*	7,3*	7,7	7,5	7,5
30,0			5,5	5,2	5,2
36,0				3,9	3,7
42,0					
44,0					
48,0					
52,0					

Boom m	24,4	30,5	39,6	48,8	51,8
Radius					
12,0	10,9*	10,9*			
14,0	10,9*	10,9*	10,9*		
18,0	9,5*	10,6*	10,9*	10,9*	10,8
24,0	7,2*	8,0	7,6	7,3	8,3
30,0	5,8*	5,8	5,4	5,2	5,1
36,0		4,4	4,1	3,8	3,6
42,0			3,1	2,8	2,7
44,0			2,7	2,5	2,4*
48,0				1,9*	1,8*
52,0					

Boom m	24,4	30,5	39,6	48,8	51,8
Radius					
10,0					
12,0					
14,0	6,9*				
18,0	5,9*	6,2*	6,6*		
24,0	5,0*	5,3*	5,7*	6,0*	6,1*
30,0		4,7*	5,1*	5,4	5,4
36,0			4,1	3,9	3,8
42,0				2,9	2,9
44,0					2,6
48,0					
52,0					

Meets EN13000 Requirements.

Notice: This capacity chart is for reference only and must not be used for lifting purposes.

For complete chart, refer to www.cranelibrary.com.

Fixed jib load charts

Model 10000E-1 liftcrane jib capacities No. 10000E-1 fixed jib on main boom

31 900 kg upper counterweight, 14 400 kg carbody counterweight crawler extended

360° Rating

kg x 1 000

10° offset

30° offset

		Boom m	24,4	30,5	39,6	48,8	51,8
Jib 15,2 m	Radius						
	10,0						
	12,0	9,0*					
	14,0	9,0*	9,0*	9,0*			
	18,0	7,8*	8,7*	9,0*	9,0*	9,0*	
	24,0	5,9*	6,6*	7,7	7,4	7,3	
	30,0	4,8*	5,4*	5,6	5,2	5,1	
	36,0		4,5*	4,1	3,8	3,7	
	42,0			3,2	2,9	2,8	
	44,0			2,9	2,6	2,5	
	48,0			2,2	2,1*	1,9*	
	52,0				1,5*		

		Boom m	24,4	30,5	39,6	48,8	51,8
Jib 15,2 m	Radius						
	10,0						
	12,0						
	14,0						
	18,0	4,8*	5,0*				
	24,0	4,0*	4,2*	4,5*	4,7*	4,8*	
	30,0	3,5*	3,7*	3,9*	4,1*	4,2*	
	36,0			3,6*	3,8*	3,9	
	42,0				3,0	3,0	
	44,0				2,7	2,7	
	48,0						
	52,0						

		Boom m	24,4	30,5	39,6	48,8	51,8
Jib 18,3 m	Radius						
	10,0						
	12,0						
	14,0	8,1*	8,1*				
	18,0	6,8*	7,5*	8,1*	8,1*	8,1*	
	24,0	5,1*	5,7*	6,5*	7,2*	8,0*	
	30,0	4,1*	4,6*	5,2*	5,3*	5,2	
	36,0	3,4*	3,8*	4,2	3,9	3,8	
	42,0		3,3*	3,2	2,9	2,8	
	44,0		3,1*	2,9	2,6	2,5	
	48,0			2,4*	2,1*	2,0*	
	52,0				1,6*	1,5*	

		Boom m	24,4	30,5	39,6	48,8	51,8
Jib 18,3 m	Radius						
	10,0						
	12,0						
	14,0						
	18,0						
	24,0	3,4*	3,5*	3,7*	3,9*	3,9*	
	30,0	2,9*	3,0*	3,2*	3,4*	3,5*	
	36,0		2,7*	2,9*	3,1*	3,2*	
	42,0			2,6*	2,8*	2,9*	
	44,0				2,7*	2,6*	
	48,0				2,3	2,2*	
	52,0						

Meets EN13000 Requirements.

Notice: This capacity chart is for reference only and must not be used for lifting purposes.

For complete chart, refer to www.cranelibrary.com.

Clamshell

Main hoist loads

No. of parts of line	1
Maximum loads	98 kN
Maximum loads	10,0 t

1. Operating radius is the horizontal distance from centerline of rotation to a vertical line through the center of gravity of the load.
2. Deduct weight of bucket, slings and all other load handling accessories from main boom ratings shown.
3. Ratings shown are based on freely suspended loads and make no allowance for such factors as wind effect on lifted load, ground conditions, out-of-level, operating speeds or any other condition that could be detrimental to the safe operation of this equipment. The operator, therefore, has the responsibility to judge the existing conditions and reduce lifted loads and operating speeds accordingly.
4. Rated loads do not exceed 66% of minimum tipping loads.
5. Ratings are for operation on a firm and level surface, up to 1% gradient.
6. At radii and boom lengths where no ratings are shown on chart, operation is not intended nor approved.
7. Boom inserts and guy lines must be arranged as shown in the "operator's manual".
8. Boom hoist reeving is 12 part line.
9. Gantry must be in raised position for all conditions.
10. Boom backstops are required for all boom lengths.
11. The boom should be erected over the front of the crawlers, not laterally.
12. Crawler frames must be fully extended for all crane operations.

Clamshell bucket lifting

1. The total load that can be lifted is the value for weight of bucket, slings, and all other load handling accessories deducted from main boom ratings shown.
2. The weight of bucket and materials must not exceed rated load.
3. Optimum bucket should be required according to material. Bucket capacity (m³) x specified gravity of material (ton/m³) + bucket weight (ton) = rated load.
4. Bucket weight must also be decreased according to operating cycle and bucket lowering height.
5. Rated loads are determined by stability and boom strength. During simultaneous operations of boom and swing, rapid acceleration or deceleration must be avoided.
6. Do not attempt to cast the bucket while swinging or diagonal draw-cutting.

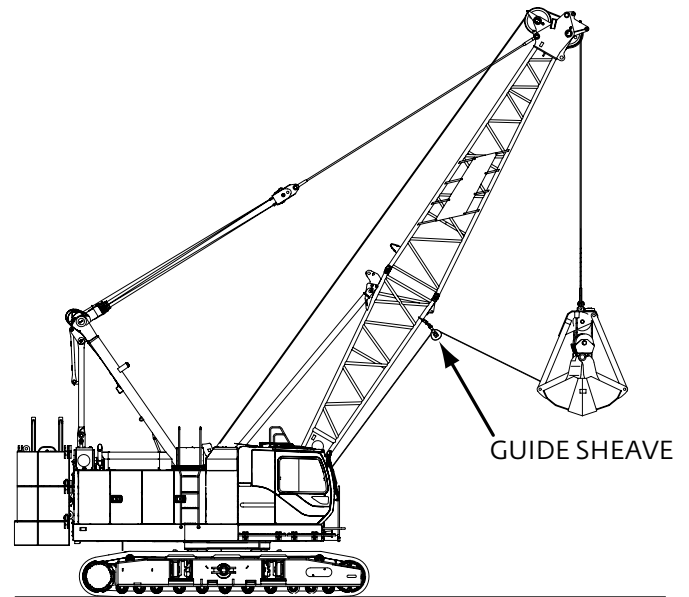

Clamshell Capacities

20,5 t counterweight
(crawlers extended)

Boom m	kg x 1 000				
	12,2	15,2	18,3	21,3	24,4
Radius					
5,0	10,0				
6,0	10,0	10,0			
7,0	10,0	10,0	10,0		
8,0	10,0	10,0	10,0	9,5	
9,0	10,0	10,0	10,0	9,5	8,7
10,0	9,8	9,7	9,6	9,5	8,7
11,0	9,1	9,0	8,9	8,8	8,7
12,0		8,3	8,2	8,1	8,0
13,0		7,7	7,6	7,5	7,4
14,0		7,1	7,0	6,9	6,8
15,0			6,5	6,4	6,3
16,0			6,1	6,0	5,9
17,0				5,7	5,6
18,0				5,4	5,3
19,0				5,2	5,1
20,0					4,9
21,0					4,7

Manitowoc Crane Care

Crane Care is Manitowoc's comprehensive service and support program. It includes classroom and on-site training, prompt parts availability, expert field service, technical support and documentation.

That's commitment you won't find anywhere else.

That's Crane Care.

Service training

Manitowoc specialists work with you in our training centers and in the field to make sure you know how to get maximum performance, reliability and life from your cranes.

Manitowoc Cranes Technical Training Centers provide valuable multi-level training, which is available for all models and attachments, in the following format:

- **Intro to Canbus and Canbus 1, 2, 3**
- **Intro to EPIC and EPIC 1, 2, 3**
- **Small Crawler 1**
- **Canbus 1 and 2 assembly, operation and maintenance**
- **EPIC 1 and 2 assembly, operation and maintenance**

Refer to www.manitowoc.com for course descriptions.

Parts availability

Genuine Manitowoc replacement parts are accessible through your distributor 24 hours a day, 7 days a week, 365 days a year.

Service interval kits

200 hour kit

1,000 hour kit

2,000 hour kit

Hydraulic test kit

U.S. standard tools kit

Field service

Factory-trained service experts are always ready to help maintain your crane's peak performance.

For a worldwide listing of dealer locations, please consult our website at: www.manitowoc.com

Technical support

Manitowoc's dealer network and factory personnel are available 24 hours a day, 7 days a week, 365 days a year to answer your technical questions and more, with the help of computerized programs that simplify

crane selection, lift planning, and ground-bearing calculations.

For a worldwide listing of dealer locations, please consult our website at: www.manitowoc.com

Technical documentation

Manitowoc has the industry's most extensive documentation; available in major languages and formats that include print, videotape, and DVD/CD.

Additional copies available through your Authorized Manitowoc Distributor.

- Crane operator's manual
- Crane parts manual
- Crane capacity manual
- Crane vendor manual
- Crane service manual
- Luffing jib operator's/parts manual
- Capacity chart manual - attachments

Available from your Authorized Manitowoc Cranes Distributor, these videos are available in NTSC, PAL, SECAM, and DVD formats.

- Your Capacity Chart Video
- Respect the Limits Video
- Crane Safety Video
- Boom Inspection/Repair Video

Crane Care Package

Manitowoc has assembled all of the available literature, CD's and videos listed above plus several Manitowoc premiums into one complete Crane Care Package, which is supplied to the owner of each new crane.

Manitowoc Cranes

Regional headquarters

Americas

Manitowoc, Wisconsin, USA

Tel: +1 920 684 6621

Fax: +1 920 683 6277

Shady Grove, Pennsylvania, USA

Tel: +1 717 597 8121

Fax: +1 717 597 4062

Europe, Middle East, Africa

Ecully, France

Tel: +33 (0)4 72 18 20 20

Fax: +33 (0)4 72 18 20 00

China

Shanghai, China

Tel: +86 21 6457 0066

Fax: +86 21 6457 4955

Greater Asia-Pacific

Singapore

Tel: +65 6264 1188

Fax: +65 6862 4040

Regional offices

Americas

Brazil

Alphaville

Mexico

Monterrey

Chile

Santiago

Europe, Middle East, Africa

Czech Republic

Netvorice

France

Baudemont

Cergy

Decines

Germany

Langenfeld

Hungary

Budapest

Italy

Lainate

Netherlands

Breda

Poland

Warsaw

Portugal

Baltar

Russia

Moscow

South Africa

Johannesburg

U.A.E.

Dubai

U.K.

Buckingham

China

Beijing

Chengdu

Guangzhou

Xian

Greater Asia-Pacific

Australia

Brisbane

Melbourne

Sydney

India

Chennai

Delhi

Hyderabad

Pune

Korea

Seoul

Philippines

Makati City

Singapore

Factories

Brazil

Passo Fundo

China

TaiAn

Zhangjiagang

France

Charlieu

Moulins

Germany

Wilhelmshaven

India

Pune

Italy

Niella Tanaro

Portugal

Baltar

Fânzeres

Slovakia

Saris

USA

Manitowoc

Port Washington

Shady Grove

This document is non-contractual. Constant improvement and engineering progress make it necessary that we reserve the right to make specification, equipment, and price changes without notice. Illustrations shown may include optional equipment and accessories and may not include all standard equipment.