

Potain Plus

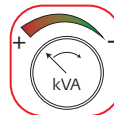

Power Control



Top Site

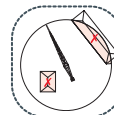

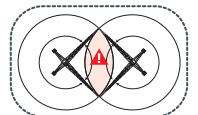

Anti-collision systems



Mât - Réactions / Mast - Reaktionskräfte / Mast - Reactions / Mástil - Reacciones / Torre - Reazioni  
 Tramo - Reacções / Реакция опор мачты

2,45 m - P 800B - C25											
ΔΔΔΔΔ (m)	35	40	45	50	55	60	65	70	75	80	
↕ (m)	68,6	68,6	68,6	70,2	68,6	68,6	68,6	66,9	65,2	65,2	
↕/P+ (m)	68,6	68,6	68,6	70,2	68,6	68,6	68,6	66,9	65,2	65,2	
	3,33 m	1	1	1	1	1	1	1	1	1	
	2 m	1	1	1	1	1	1	1	1	1	
	3,33 m	0	0	0	2	0	0	0	1	2	
	5 m	13	13	13	12	13	13	13	12	11	11
F2 (t)	●	232	231	230	232	229	233	239	236	232	231
	■	320	323	319	349	326	327	323	312	302	305
F3 (t)	●	156	153	160	149	153	154	159	154	150	147
	■	253	255	248	276	250	248	243	230	219	221
↕ (m) D25	63,6	63,6	63,6	63,6	63,6	63,6	63,6	63,6	63,6	63,6	
↕/P+ (m) D25	63,6	63,6	63,6	63,6	63,6	63,6	63,6	63,6	63,6	63,6	

2,45 m - ZY 800 -  - C25											
ΔΔΔΔΔ (m)	35	40	45	50	55	60	65	70	75	80	
↕ (m)	66,6	66,6	64,9	68,3	66,6	66,6	66,6	64,9	63,3	63,3	
↕/P+ (m)	59,9	59,9	56,6	59,9	58,3	59,9	59,9	61,6	63,3	63,3	
	3,33 m	1	1	1	1	1	1	1	1	1	
	2 m	1	1	1	1	1	1	1	1	1	
	3,33 m	2	2	0	1	2	2	0	1	1	
	5 m	11	11	12	12	11	11	11	12	11	11
F1 (t)	●	128	126	124	128	129	130	131	133	133	132
	■	141	143	127	152	144	144	141	134	131	133
↕ (m) D25	63,3	63,3	63,3	63,3	63,3	63,3	63,3	63,3	63,3	63,3	
↕/P+ (m) D25	59,9	59,9	56,6	59,9	58,3	59,9	59,9	61,6	63,3	63,3	

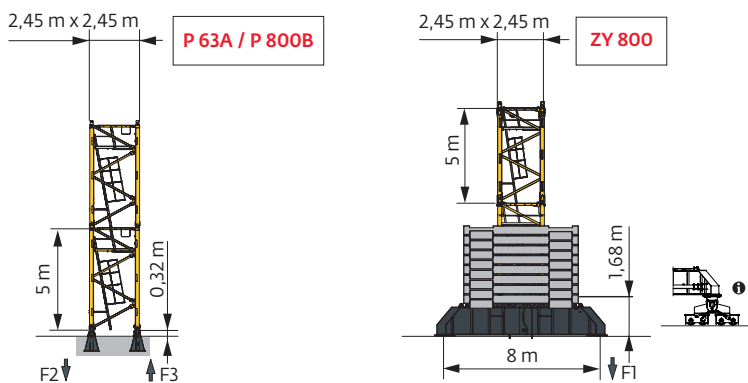



**i** Autres compositions de pylône - Nous consulter. / Andere Turmaufbauten - bitte kontaktieren Sie uns. / Other mast compositions - Please consult us. / Para otras composiciones de mástil - Por favor contactémos. / Per altre composizioni torre, contattateci. / Para outras composições de coluna - Por favor, consulte-nos. / Для других композиций мачты пожалуйста консультируйтесь с нами.

Accès motorisés : compositions de mât, de lest de base et réactions adaptées. / Motorisierter Zugang vom : Mastzusammensetzung, Grundballast und Reaktionskräfte sind angepasst. / Motorized accesses: adapted mast composition, base ballast and reactions. / Acceso a cabina con elevador: Adaptación de composición de mástil, lastre de base y reacciones. / Accessi motorizzati: composizioni elementi torre, zavorre di base e reazioni aggiornate. / Acessos motorizados: composições de coluna, lastro da base e reacções adaptadas. / Лифты : адаптированная композиция мачты, базовый балласт и нагрузки.

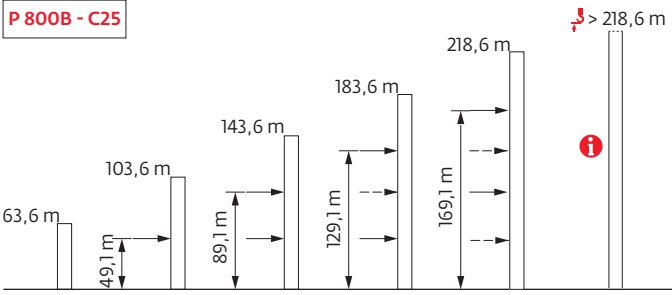
Ancrages / Verankerungen / Anchorages / Anclajes / Ancoraggi  
 Ancoragem / якоря



Lest de base / Grundballast / Base ballast / Lastre de base / Zavorra di base  
 Lastro da base / Базовый Балласт

 (t) /  2,45 m - ZY 800 -  - C25										
▲▼▲▲ (m)	35	40	45	50	55	60	65	70	75	80
68,3	84									
66,6	96	84		84	84	84	84			
64,9	84	84	84	84	84	84	84	96		
63,3	84	84	84	84	84	84	84	96	96	96
58,3	84	84	84	84	84	84	84	84	96	96
53,3	84	84	84	84	84	84	84	84	84	96
48,3	84	84	84	84	84	84	84	84	84	84
43,3	84	84	84	84	84	84	84	84	84	84
38,3	84	84	84	84	84	84	84	84	84	84
33,3	84	84	84	84	84	84	84	84	84	84
28,3	84	84	84	84	84	84	84	84	84	84
23,3	84	84	84	84	84	84	84	84	84	84

Courbes de charges / Lastkurven / Load curves / Curvas de cargas / Curve di carico  
 Curvas de carga / Кривые нагрузок



▼▲▲▲ (m)		22	25	27	30	32	35	37	40	42	45	47	50	52	55	57	60	62	65	67	70	72	75	77	80	m
▼▲▲▲	↵ 20 t	↵																								
80	2,9 → 25,5	20	20	18,7	16,5	15,3	13,7	12,8	11,6	10,9	10,1	9,6	8,8	8,4	7,9	7,5	7	6,7	6,3	6,1	5,7	5,4	5	4,8	4,4	t
	2,9 → 26,3	20	20	19,4	17,1	15,9	14,3	13,3	12,1	11,4	10,5	10	9,3	8,8	8,2	7,9	7,4	7,1	6,7	6,4	6	5,7	5,3	5,1	4,7	t P+
75	2,9 → 27,4	20	20	20	18	16,7	15,1	14,1	12,9	12,1	11,1	10,6	9,8	9,3	8,7	8,3	7,7	7,4	6,9	6,7	6,3	6	5,7	t		
	2,9 → 27,9	20	20	20	18,4	17,1	15,4	14,5	13,2	12,5	11,5	10,9	10,1	9,6	9	8,6	8,1	7,7	7,3	7	6,6	6,3	6	t P+		
70	2,9 → 28,4	20	20	20	18,8	17,4	15,7	14,7	13,4	12,7	11,7	11,1	10,3	9,8	9,1	8,7	8,2	7,9	7,4	7,1	6,7	t				
	2,9 → 28,8	20	20	20	19,1	17,8	16,1	15,1	13,8	13	12	11,4	10,6	10,1	9,5	9,1	8,5	8,2	7,7	7,4	7	t P+				
65	2,9 → 29	20	20	20	19,2	17,9	16,1	15,1	13,8	13	12	11,4	10,6	10,1	9,4	9	8,4	8,1	7,6	t						
	2,9 → 29,4	20	20	20	19,6	18,2	16,4	15,4	14,1	13,4	12,3	11,7	10,9	10,4	9,7	9,3	8,7	8,4	7,9	t P+						
60	2,9 → 28,7	20	20	20	19	17,6	15,9	14,9	13,6	12,8	11,8	11,2	10,4	9,9	9,3	8,9	8,3	t								
	2,9 → 29,1	20	20	20	19,3	18	16,2	15,2	13,9	13,2	12,2	11,5	10,7	10,2	9,6	9,2	8,6	t P+								
55	2,9 → 28,8	20	20	20	19,1	17,7	16	15	13,7	12,9	11,9	11,3	10,5	10	9,3	t										
	2,9 → 29,1	20	20	20	19,4	18	16,3	15,3	14	13,2	12,2	11,6	10,8	10,3	9,6	t P+										
50	2,9 → 28,6	20	20	20	19	17,6	15,9	14,9	13,6	12,8	11,8	11,2	10,4	t												
	2,9 → 29	20	20	20	19,2	17,9	16,2	15,2	13,9	13,1	12,1	11,5	10,7	t P+												
45	2,9 → 29,8	20	20	20	19,8	18,4	16,6	15,6	14,3	13,5	12,4	t														
	2,9 → 30,2	20	20	20	20	18,7	16,9	15,9	14,5	13,8	12,7	t P+														
40	2,9 → 29,2	20	20	20	19,4	18	16,2	15,2	13,9	t																
	2,9 → 29,5	20	20	20	19,7	18,3	16,5	15,5	14,2	t P+																
35	2,9 → 29,6	20	20	20	19,7	18,3	16,5	t																		
	2,9 → 30	20	20	20	20	18,6	16,8	t P+																		

Poids de flèche & lest de contre-flèche / Auslegergewicht & Gegenauslegerballast / Jib weight & counter-jib ballast / Peso de flecha y lastre de contra-flecha/Peso del braccio & zavorra di contro-braccio/Peso da lança & lastro da contra lança/Вес стрелы и балласт контр-стрелы



▼▲▲▲	▼▲▲▲ (kg) (+/- 5%)	▮		▲ (kg)
	↵	6000 kg	4000 kg	
80 m	26190	6	0	36000
75 m	25690	5	1	34000
70 m	24940	4	2	32000
65 m	23855	4	1	28000
60 m	23545	3	2	26000
55 m	22460	3	1	22000
50 m	20775	2	1	16000
45 m	19690	1	2	14000
40 m	17765	1	1	10000
35 m	16685	0	2	8000

CBC - 6000 kg

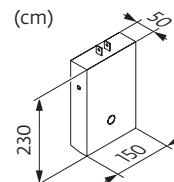
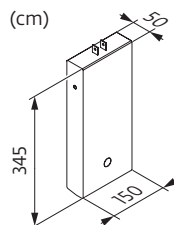



CBD - 4000 kg



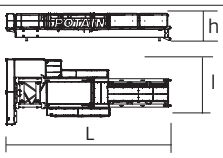
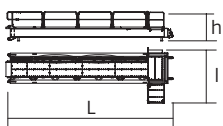
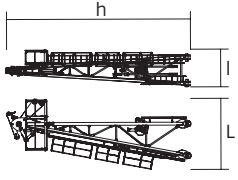
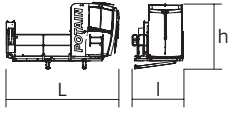
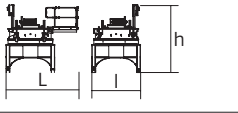
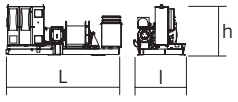
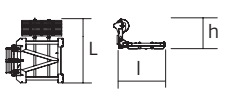
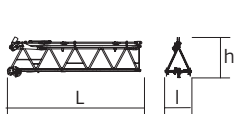
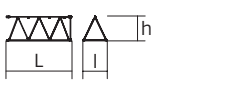
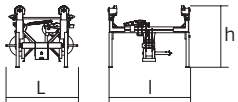

Encombrenment et poids / Abmessungen und Gewicht / Dimensions and weight / Dimensiones y peso / Ingombro e peso  
 dimensões e pesos / габаритные размеры и вес

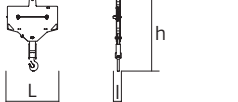



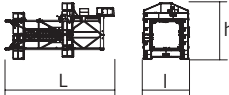
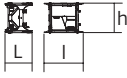
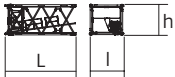
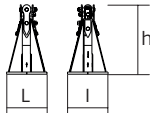
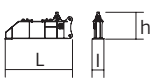

Partie tournante / Drehender Kranteil / Slewing crane part / Parte giratoria  
 Parte rotante / Parte rotativa / Поворотная часть :  80 m -  270 LVF





Partie tournante / Drehender Kranteil / Slewing crane part Parte giratoria / Parte rotante / Parte rotativa Поворотная часть	L (m)	l (m)	h (m)	kg (+/- 5%)		
Contre-flèche / Gegenausleger Counter-jib / Contra-flecha Controbraccio / Contra-lança Контр-стрела		11,7	4,7	1,96	6600	
		11,04	3,74	2,07	4925	
Porte-flèche / Auslegerträger Cathead / Porta-flecha Cuspide / Suporte de lança Оголовок		3,54	1,99	9,86	8265	
Cabine / Kabine Cab / Cabina Cabina / Cabina Кабина		Ultra View 5	2,5	2,77	1875	
Pivot / Krankopf Towerhead / Pivote Portaralla / Pivot Секция поворотной части		∇ 2,45 m 3,7	2,9	3,87	11190	
Treuil de levage (+ câble) / Hubwerk (+ Seil) Hoisting winch (+ rope) / Mecanismo de elevación (+ cabo) Argano di sollevamento (+ fune) Guincho de elevação (+ cabo) Подъемная лебедка (+ канатом)		270 LVF 5,09	2,3	2,24	9885	
Châssis intermédiaire de treuil / Zwischenrahmen des Triebwerks Intermediate winch frame / Chassis intermedio del mecanismo Chassis intermedio / Chassis intermédio do guincho средняя часть рамы лебедки		3,26	2,89	1,66	5663	
Élément de flèche / Auslegerement Jib section / Elemento de flecha Elemento di braccio / Elemento de lança Секция стрелы		①	10,36	1,9	2,54	5100
		② 15 DVF	10,33	1,9	2,34	5190
		③	10,23	1,9	2,4	3010
		④	10,23	1,9	2,33	2770
		⑤	10,23	1,9	2,32	2835
Élément de flèche / Auslegerement Jib section / Elemento de flecha Elemento di braccio / Elemento de lança Секция стрелы		⑥	5,32	1,9	2,25	1725
		⑦	5,24	1,9	2,04	1080
		⑨	5,18	1,9	1,97	550
		⑩	5,08	1,9	1,97	500
		⑧	10,21	1,9	2,02	1395
Chariot / Laufkatze Trolley / Carrello Carro / Carro-distribuidor Тележка			1,95	2,23	1,67	785
Moufle / Hubflasche Pulley block / Aparejo Bozzello / Cadernal Полиспаст			1,68	0,28	2,45	570

Рулоне / Kranturm / Crane tower Mástil / Torre / Torre Башня крана		L (m)	I (m)	h (m)	kg (+/- 5%)	
T 851		√2,45 m	11,18	4,84	5,8	15750
K 84/K 84-2 Mât de télescopiaje / Teleskopiermast Telescoping mast / Tramo de telescopaje Elemento di telescopaggio / Tramo de Telescopagem Мачта для телескопирования		√2,45 m	2,24	3,24	2,5	3050
KRM 849B KMT 849A KR 849A KRMT 849A KRMT 849C		√2,45 m	10,24 5,23 5,23 5,23 3,57	2,55 2,55 2,53 2,55 2,55	2,53 2,53 2,5 2,53 2,53	7800 3150 4290 4090 3205
Pieds de scellement / VerankerungsfüÙe Fixing angles / Pie de empotramiento Montante da annegare / Angulos fixadores анкера		P 63A / P 800B	0,75	0,75	1,28	465
1/2 Bras de croix / 1/2 Fundamentkruzträger 1/2 Cross girder / 1/2 Brazo en cruz 1/2 Braccio croce / 1/2 Braço da cruz 1/2 Поперечная балка		ZY 800	5,68	0,98	1,92	4720
Bras de croix / Fundamentkruzträger Cross girder / Brazo en cruz Braccio croce / Braço da cruz Поперечная балка		ZY 800	11,96	1,39	1,92	10075

Mécanismes / Triebwerke / Mechanisms / Mecanismos / Meccanismi  
 Mecanismos / Механизмы

400 V - 50 Hz								ch - PS hp	kW	
	<b>270 LVF 100 Optima</b>	m/min t	51 20	66,5 15	96 10	139 5	162 3,5	270	200	532 m
	<b>15 DVF 16 Optima</b>	m/min	0 → 50 (20 t) 0 → 67 (10 t) 0 → 100 (2,5 t)					15	11	
	<b>RVF 173 Optima+</b>	tr/min U/min rpm	0 → 0,7					3 x 10	3 x 7,5	
										

 IEC 60204-32		
400 V (+10% -10%) 50 Hz	257 → 149 kVA	

	FR	DE	EN	ES	IT	PT	RU
	Profil de vent suivant EN 14439 C25-D25	Windbedingungen gemäss EN 14439 C25-D25	Wind conditions according to EN 14439 C25-D25	Conformidad de los condiciones de viento EN 14439 C25-D25	Condizioni del vento secondo EN 14439 C25-D25	Perfil de vento conforme EN 14439 C25-D25	Ветровой режим в соответствии с EN 14439 C25-D25
	Équipements standards	Standardausrüstungen	Standard equipment	Equipamiento de serie	Equipaggiamento standard	Equipamento de série	Стандартное оборудование
	Équipements optionnels	Sonderausrüstungen	Options	Equipamiento opcional	Equipaggiamento in opzione	Equipamento opcional	Дополнительное оборудование (опция)
	Fonction Potain Plus : Courbes de charges Plus	Funktion Potain Plus: Plus-Lastkurven	Potain Plus function: Plus load curves	Función Potain Plus: Diagrama de cargas Plus	Funzione Potain Plus: Curve di carico Plus	Função Potain Plus: Diagrama de cargas Plus	Функция контроля мощности Potain Plus: Диаграммы грузоподъемности Plus
	Hauteurs sous crochet associées aux courbes de charges Plus	Hakenhöhen mit Plus-Lastkurven	Hook heights with Plus load curves	Altura bajo gancho, usando el diagrama de cargas Plus	Altezze sotto gancio con curve di carico Plus	Altura livre, utilizando o diagrama de cargas Plus	Высота под крюком для диаграмм грузоподъемности Plus
	Réactions en service	Reaktionskräfte in Betrieb	Reactions in service	Reacciones en servicio	Reazioni in servizio	Reações em serviço	Реакция при работе
	Réactions hors service	Reaktionskräfte außer Betrieb	Reactions out of service	Reacciones fuera de servicio	Reazioni fuori servizio	Reações fora de serviço	Реакция в покое
	Poids total du lest	Ballast-Gesamtgewicht	Total ballast weight	Peso total del lastre	Peso totale della zavorra	Peso total do lastro	Общий вес балласта
	Cadre d'ancrage serré	Fester Verankerungsrahmen	Tightened anchorage frame	Marco de anclaje de apriete	Quadro di ancoraggio stretto	Quadro de amarração apertado	Прикрепленная анкерная рама
	Cadre d'ancrage desserré	Loser Verankerungsrahmen	Loosened anchorage frame	Marco de anclaje de desapriete	Quadro di ancoraggio allentato	Quadro de amarração solto	Отсоединенная анкерная рама
	Poids de flèche	Auslegergewicht	Jib weight	Peso de flecha	Peso del braccio	Peso da lança	вес стрелы
	Camion 13,4 m	Lkw 13,4 m	Lorry 13,4 m	Camión 13,4 m	Camion 13,4 m	Camião 13,4 m	Ррузовой автомобиль 13,4 м
	Conteneur High Cube 40', et/ou Flat Rack 20'	Container High Cube 40', und/oder Flat Rack 20'	Container High Cube 40', and/or Flat Rack 20'	Contenedor High Cube 40', y/o Flat Rack 20'	Container High Cube 40', e/o Flat Rack 20'	Contentor High Cube 40', e/ou Flat Rack 20'	40-футовый контейнер повышенной вместимости High Cube, и/или 20-футовая открытая платформа Flat Rack
	Levage	Heben	Hoisting	Elevación	Sollevamento	Elevação	Подъем
	Distribution	Katzfahren	Trolleying	Distribución	Distribuzione	Distribuição	Перемещение по стреле
	Orientation	Schwenken	Slewing	Orientación	Rotazione	Rotação	Поворот
	Translation	Kranfahren	Travelling	Traslación	Traslazione	Translação	Перемещение крана
	Puissance requise	Erforderliche Leistung	Required power	Potencia Necesaria	Potenza richiesta	Potência Necessária	Потребляемая мощность
	Fonction Power Control : vitesses treuils adaptées à la puissance disponible	Funktion Power Control: Geschwindigkeiten der Triebwerke werden an die verfügbare Leistung angepasst	Power Control Function: winch speeds adapted to the available power	Función Power Control: marchas de los cabrestantes adaptadas a la potencia disponible	Funzione Power Control: velocità degli argani adattate alla potenza disponibile	Função Power Control: velocidades de guincho adaptadas à potência disponível	Функция контроля мощности Power Control: регулировка скорости лебедок в зависимости от доступной мощности
	Nous consulter	Auf Anfrage	Consult us	Consultarnos	Consultateci	Consultar-nos	Проконсультируйтесь у нас
	Document commercial non contractuel. Pour toute information technique se référer à la notice correspondante.	Unverbindliches Vertriebsdokument. Für technische Informationen, siehe die entsprechenden Anweisungen.	This commercial document is not legally binding. For any technical information, please refer to the corresponding instructions.	Documento comercial no contractual. Para cualquier información técnica, ver la noticia correspondiente.	Documento commerciale non vincolante, per tutte le informazioni tecniche fare riferimento al catalogo istruzioni.	Documento comercial não contractual. Para qualquer informação técnica complementar consultar as respectivas instruções.	Этот коммерческий документ не является юридически обязательным. Для получения технической информации, см. соответствующие инструкции.

