

MDT 249 J10

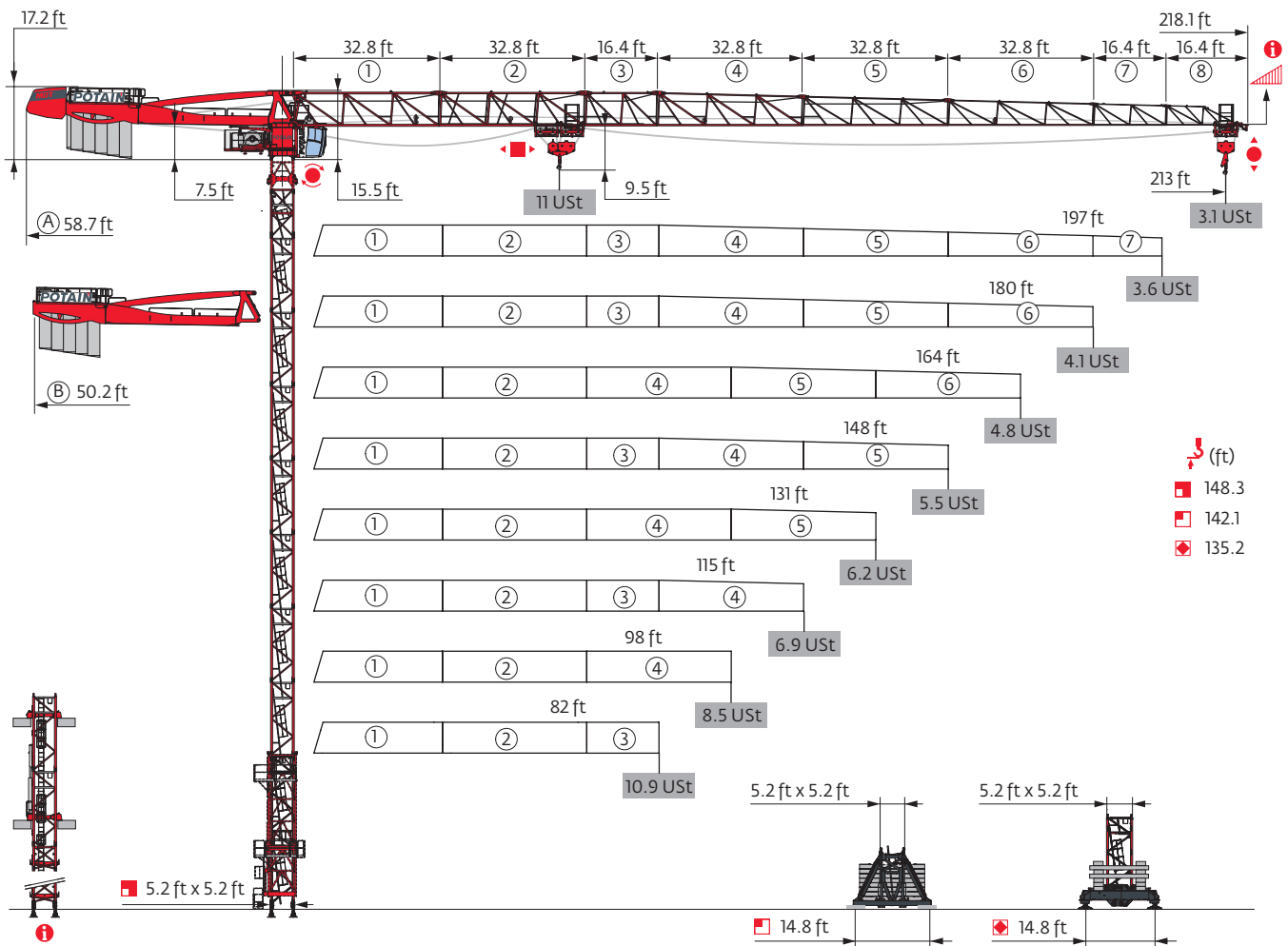

Potain Plus Power Control Top Site Anti-collision systems

The image shows four logos in a row:

- Potain Plus:** A red circle containing the text "P+".
- Power Control:** A red circle containing a gauge with "kVA" and a red needle.
- Top Site:** A red circle containing a diagram of a crane hook and a red "X" mark.
- Anti-collision systems:** A red circle containing a diagram of two overlapping circles with a red "X" mark.

Mast - Reactions

5.2 ft City - P 42A									
Height (ft)	82	98	115	131	148	164	180	197	213
Height (ft)	147	147	147	141.7	147	147	147	136.2	136.2
Height + P+ (ft)	147	147	147	141.7	147	147	147	136.2	136.2
10.9 ft	0	0	0	1	0	0	0	2	2
16.4 ft	7	7	7	6	7	7	7	5	5
32.8 ft	1	1	1	1	1	1	1	1	1
F2 (Ust)	● 153	152	149	148	146	145	146	142	143
	■ 118	117	123	111	128	130	138	116	124
F3 (Ust)	● 119	117	112	111	102	101	100	101	97
	■ 84	82	87	74	89	91	98	75	83

5.2 ft City - S 41A									
Height (ft)	82	98	115	131	148	164	180	197	213
Height (ft)	141.1	141.1	141.1	141.1	141.1	141.1	135.5	130.2	135.5
Height + P+ (ft)	141.1	141.1	141.1	141.1	141.1	141.1	135.5	130.2	135.5
10.9 ft	0	0	0	0	0	0	1	2	1
16.4 ft	8	8	8	8	8	8	7	6	7
F1 (Ust)	● 86	86	87	87	85	85	88	86	88
	■ 71	71	73	72	73	74	74	71	77

5.2 ft City - ZD 463									
Height (ft)	82	98	115	131	148	164	180	197	213
Height (ft)	134.2	134.2	134.2	134.2	134.2	134.2	128.6	123.4	128.6
Height + P+ (ft)	134.2	134.2	134.2	134.2	134.2	134.2	128.6	123.4	128.6
10.9 ft	0	0	0	0	0	0	1	2	1
16.4 ft	8	8	8	8	8	8	7	6	7
F1 (Ust)	● 84	83	83	83	82	82	84	82	85
	■ 67	67	68	68	68	69	69	65	72

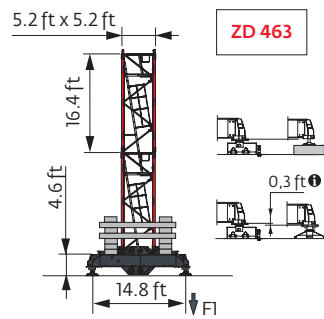
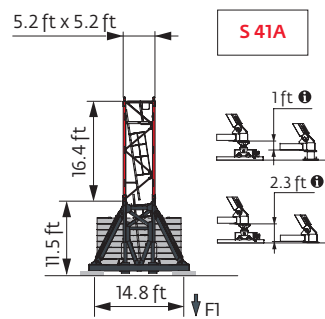
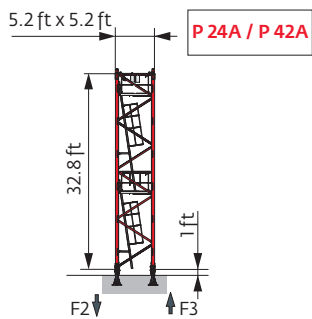

Note: When "ASCE" is noted in this data sheet it is referring to 115 mph Wind Zone, Exposure B, Design Wind Speed = 98 mph. See back cover for design wind speed calculations.

Motorized accesses: adapted mast compositions, base ballast and reactions.

Other mast compositions - Please consult us

5.2 ft - P 42A

Height (ft)	82	98	115	131	148	164	180	197	213
\bar{z} (ft)	148.3	142.7	142.7	142.7	142.7	142.7	142.7	131.9	131.9
\bar{z}/P_z (ft)	148.3	142.7	142.7	142.7	142.7	142.7	142.7	131.9	131.9
	6.6 ft	1	1	1	1	1	1	1	1
	10.9 ft	1	2	2	2	2	2	1	1
	16.4 ft	6	5	5	5	5	5	5	5
	32.8 ft	1	1	1	1	1	1	1	1
F2 (Ust)	● 158	152	149	152	147	145	147	141	143
	■ 137	127	133	129	138	140	147	120	129
F3 (Ust)	● 123	117	113	114	102	101	101	101	97
	■ 102	92	97	92	99	101	107	80	88

5.2 ft - S 41A -

Height (ft)	82	98	115	131	148	164	180	197	213
\bar{z} (ft)	142.1	136.8	136.8	136.8	142.1	142.1	131.2	125.7	131.2
\bar{z}/P_z (ft)	142.1	136.8	136.8	136.8	142.1	142.1	131.2	125.7	131.2
	6.6 ft	1	1	1	1	1	1	1	1
	10.9 ft	1	2	2	2	1	1	0	0
	16.4 ft	7	6	6	6	7	7	7	6
FI (Ust)	● 90	86	87	87	89	89	87	85	88
	■ 78	73	76	75	81	81	75	71	78

5.2 ft - ZD 463 -

Height (ft)	82	98	115	131	148	164	180	197	213
\bar{z} (ft)	135.2	135.2	129.9	129.9	135.2	135.2	129.9	124.3	124.3
\bar{z}/P_z (ft)	135.2	135.2	129.9	129.9	135.2	135.2	129.9	124.3	124.3
	6.6 ft	1	1	1	1	1	1	1	1
	10.9 ft	1	1	2	2	1	1	2	0
	16.4 ft	7	7	6	6	7	7	6	7
FI (Ust)	● 87	85	83	83	85	85	87	84	85
	■ 73	72	70	69	75	75	75	70	72

Anchorage



Base ballast

(Ust) / 5.2 ft City - S 41A -

Δ (ft)	82	98	115	131	148	164	180	197	213
141.1	99.2	99.2	99.2	99.2	92.6	92.6			
135.5	99.2	92.6	92.6	92.6	86	86	92.6		92.6
130.2	92.6	92.6	92.6	86	79.4	79.4	86	92.6	86
113.8	79.4	72.8	72.8	72.8	66.1	66.1	72.8	72.8	72.8
97.4	72.8	66.1	59.5	66.1	59.5	52.9	52.9	59.5	66.1
81	72.8	59.5	59.5	59.5	59.5	52.9	46.3	52.9	66.1
64.6	72.8	59.5	59.5	59.5	59.5	52.9	46.3	52.9	59.5

(Ust) / 5.2 ft City - ZD 463 -

Δ (ft)	82	98	115	131	148	164	180	197	213
134.2	93.7	88.2	88.2	88.2	82.7	82.7			
128.6	88.2	88.2	82.7	82.7	77.2	77.2	82.7		82.7
123.4	82.7	82.7	82.7	77.2	71.7	71.7	77.2	77.2	77.2
107	71.7	66.1	66.1	66.1	55.1	55.1	60.6	60.6	66.1
90.6	66.1	60.6	55.1	55.1	55.1	49.6	44.1	55.1	60.6
74.2	66.1	55.1	55.1	55.1	55.1	49.6	44.1	49.6	60.6
57.7	66.1	55.1	55.1	55.1	55.1	49.6	44.1	49.6	60.6

(Ust) / 5.2 ft - S 41A -

Δ (ft)	82	98	115	131	148	164	180	197	213
142.1	105.8				99.2	99.2			
136.8	105.8	99.2	99.2	99.2	92.6	92.6			
131.2	99.2	92.6	92.6	92.6	86	86	92.6		92.6
125.7	92.6	92.6	86	86	79.4	79.4	86	86	86
109.3	79.4	72.8	72.8	72.8	66.1	66.1	72.8	72.8	66.1
93.2	66.1	66.1	59.5	66.1	59.5	59.5	52.9	59.5	66.1
76.8	66.1	59.5	52.9	59.5	59.5	52.9	46.3	52.9	66.1
60.4	66.1	59.5	52.9	59.5	59.5	52.9	46.3	52.9	66.1

(Ust) / 5.2 ft - ZD 463 -

Δ (ft)	82	98	115	131	148	164	180	197	213
135.2	99.2	93.7			88.2	88.2			
129.9	93.7	88.2	88.2	88.2	82.7	82.7	88.2		
124.3	88.2	82.7	82.7	82.7	77.2	77.2	82.7	82.7	82.7
107.9	71.7	71.7	66.1	66.1	60.6	60.6	66.1	66.1	66.1
91.5	66.1	60.6	55.1	60.6	55.1	55.1	49.6	55.1	60.6
75.1	66.1	55.1	55.1	55.1	55.1	49.6	44.1	49.6	60.6
58.7	66.1	55.1	55.1	55.1	55.1	49.6	44.1	49.6	60.6

Load curves



▽ (ft)		56	66	72	82	89	98	105	115	121	131	138	148	154	164	171	180	187	197	203	213	ft
▽	USt	▽										▽										
▽	5.5 USt	▽										▽										
213	10 → 64	11	10.6	9.5	8.2	7.5	6.6	6.1	5.5	5.5	5.1	4.8	4.5	4.2	3.9	3.7	3.5	3.4	3.1	3	2.85	USt
	10 → 66	11	11	9.9	8.5	7.8	6.9	6.4	5.7	5.5	5.4	5.1	4.7	4.5	4.2	4	3.7	3.6	3.4	3.2	3.1	USt P+
197	10 → 67	11	11	10.1	8.7	7.9	7	6.4	5.8	5.5	5.4	5.1	4.7	4.5	4.2	4	3.7	3.6	3.3	3	2.85	USt
	10 → 69	11	11	10.5	9.1	8.3	7.3	6.8	6.1	5.7	5.5	5.4	5	4.8	4.4	4.2	4	3.8	3.6	3.4	3.1	USt P+
180	10 → 68	11	11	10.2	8.8	8.1	7.1	6.6	5.9	5.5	5.5	5.2	4.8	4.6	4.2	4	3.8	3.6	3.4	3.1	2.85	USt
	10 → 70	11	11	10.7	9.3	8.5	7.5	7	6.3	5.9	5.5	5.5	5.1	4.9	4.5	4.3	4.1	3.8	3.6	3.4	3.1	USt P+
164	10 → 70	11	11	10.7	9.3	8.5	7.5	6.9	6.2	5.8	5.5	5.4	5	4.8	4.4	4.1	3.8	3.6	3.4	3.1	2.85	USt
	10 → 74	11	11	11	9.8	9	7.9	7.4	6.6	6.2	5.7	5.5	5.4	5.1	4.8	4.5	4.2	4	3.7	3.6	3.4	USt P+
148	10 → 73	11	11	11	9.6	8.8	7.8	7.2	6.5	6.1	5.5	5.5	5.2	4.8	4.4	4.1	3.8	3.6	3.4	3.1	2.85	USt
	10 → 77	11	11	11	10.2	9.3	8.3	7.7	6.9	6.5	5.9	5.6	5.5	5.2	4.8	4.5	4.2	4	3.7	3.6	3.4	USt P+
131	10 → 74	11	11	11	9.9	9	8	7.4	6.6	6.2	5.7	5.5	5.4	5.1	4.8	4.5	4.2	4	3.7	3.6	3.4	USt
	10 → 78	11	11	11	10.5	9.6	8.5	7.9	7.1	6.7	6.1	5.8	5.5	5.2	4.8	4.5	4.2	4	3.7	3.6	3.4	USt P+
115	10 → 71	11	11	10.9	9.4	8.6	7.6	7	6.3	5.9	5.5	5.5	5.2	4.8	4.5	4.2	4	3.7	3.6	3.4	3.1	USt
	10 → 75	11	11	11	10	9.2	8.2	7.6	6.8	6.4	5.8	5.5	5.4	5.1	4.8	4.5	4.2	4	3.7	3.6	3.4	USt P+
98	10 → 73	11	11	11	9.6	8.8	7.7	7.1	6.4	6.0	5.5	5.5	5.2	4.8	4.5	4.2	4	3.7	3.6	3.4	3.1	USt
	10 → 77	11	11	11	10.3	9.4	8.4	7.8	7.1	6.7	6.1	5.6	5.5	5.2	4.8	4.5	4.2	4	3.7	3.6	3.4	USt P+
82	10 → 75	11	11	11	10	9.2	8.2	7.6	6.8	6.4	5.8	5.5	5.4	5.1	4.8	4.5	4.2	4	3.7	3.6	3.4	USt
	10 → 81	11	11	11	10.8	9.9	8.9	8.3	7.6	7.2	6.6	6.1	5.6	5.5	5.2	4.8	4.5	4.2	4	3.7	3.6	USt P+

$W = U - 0.53 \text{ USt max.}$



▽ (ft)		56	66	72	82	89	98	105	115	121	131	138	148	154	164	171	180	187	197	203	213	ft
▽	USt	▽										▽										
▽	5.5 USt	▽										▽										
213	8 → 64	11	10.7	9.6	8.3	7.5	6.6	6.1	5.5	5.3	4.8	4.5	4.1	3.9	3.6	3.4	3.2	3	2.85	2.7	2.55	USt
	8 → 66	11	11	9.9	8.6	7.9	7	6.5	5.8	5.5	5.1	4.8	4.4	4.2	3.9	3.7	3.4	3.3	3	2.9	2.75	USt P+
197	8 → 67	11	11	10.1	8.7	8	7	6.5	5.8	5.5	5.1	4.8	4.4	4.2	3.9	3.7	3.4	3.2	3	2.85	2.7	USt
	8 → 70	11	11	10.6	9.1	8.4	7.4	6.9	6.2	5.8	5.4	5.1	4.7	4.5	4.1	3.9	3.7	3.5	3.3	3	2.85	USt P+
180	8 → 68	11	11	10.3	8.9	8.1	7.2	6.7	6	5.6	5.2	4.9	4.5	4.3	4	3.8	3.5	3.3	3	2.85	2.7	USt
	8 → 71	11	11	10.8	9.4	8.6	7.6	7.1	6.4	6	5.5	5.3	4.9	4.6	4.3	4.1	3.8	3.6	3.4	3.1	2.85	USt P+
164	8 → 71	11	11	10.8	9.3	8.5	7.6	7	6.3	5.9	5.5	5.2	4.8	4.5	4.2	4	3.8	3.6	3.4	3.1	2.85	USt
	8 → 74	11	11	11	9.9	9	8	7.5	6.7	6.3	5.7	5.5	5.1	4.9	4.5	4.2	4	3.7	3.6	3.4	3.1	USt P+
148	8 → 73	11	11	11	9.7	8.9	7.8	7.3	6.5	6.1	5.6	5.4	5	4.8	4.4	4.1	3.8	3.6	3.4	3.1	2.85	USt
	8 → 77	11	11	11	10.3	9.4	8.4	7.8	7	6.6	6	5.7	5.4	5	4.6	4.3	4	3.7	3.6	3.4	3.1	USt P+
131	8 → 75	11	11	11	9.9	9.1	8.1	7.5	6.7	6.3	5.7	5.5	5.1	4.8	4.5	4.2	4	3.7	3.6	3.4	3.1	USt
	8 → 79	11	11	11	10.6	9.7	8.6	8	7.2	6.8	6.2	5.7	5.4	5	4.6	4.3	4	3.7	3.6	3.4	3.1	USt P+
115	8 → 72	11	11	11	9.5	8.7	7.7	7.1	6.4	6	5.5	5.5	5.2	4.8	4.5	4.2	4	3.7	3.6	3.4	3.1	USt
	8 → 76	11	11	11	10.1	9.3	8.2	7.7	6.9	6.5	5.9	5.6	5.3	4.9	4.6	4.3	4	3.7	3.6	3.4	3.1	USt P+
98	8 → 73	11	11	11	9.7	8.8	7.8	7.2	6.5	6.1	5.5	5.5	5.2	4.8	4.5	4.2	4	3.7	3.6	3.4	3.1	USt
	8 → 78	11	11	11	10.4	9.5	8.5	7.9	7.2	6.8	6.2	5.7	5.4	5	4.6	4.3	4	3.7	3.6	3.4	3.1	USt P+
82	8 → 76	11	11	11	10.1	9.2	8.2	7.6	6.8	6.4	5.8	5.5	5.4	5.1	4.8	4.5	4.2	4	3.7	3.6	3.4	USt
	8 → 81	11	11	11	10.9	10	9	8.4	7.7	7.3	6.7	6.2	5.7	5.5	5.2	4.8	4.5	4.2	4	3.7	3.6	USt P+

$W = U - 0.14 \text{ USt max.}$

Jib weight & counter-jib ballast



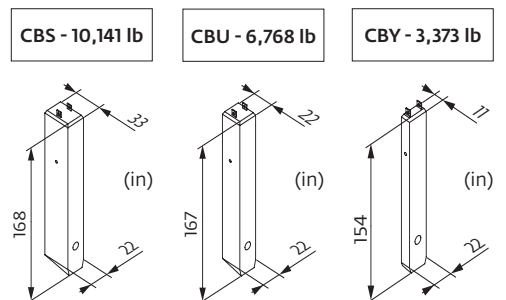

ft	Jib Weight (lb) (+/- 5%)			CBS-10,141 lb			CBU-6,768 lb			CBY-3,373 lb		
	USt	USt	USt	10,141 lb	3,373 lb	(lb)	6,768 lb	3,373 lb	(lb)	3,373 lb	(lb)	
213 ft	27,472	26,863	27,672	5	1	54,079	7	2	54,123			
197 ft	26,978	26,369	27,179	5	1	54,079	7	2	54,123			
180 ft	26,131	25,589	26,288	5	0	50,706	7	1	50,750			
164 ft	24,273	23,731	24,429	4	2	47,311	6	2	47,355			
148 ft	24,588	24,046	24,745	4	2	47,311	6	2	47,355			
131 ft	22,800	22,258	22,957	4	1	43,938	6	1	43,982			
115 ft	22,536	21,993	22,692	4	0	40,565	5	2	40,587			
98 ft	20,435	19,892	20,591	3	2	37,170	5	1	37,214			
82 ft	19,268	18,726	19,425	3	1	33,797	4	2	33,819			



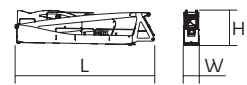
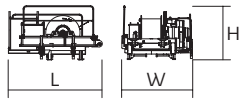

Dimensions and weight

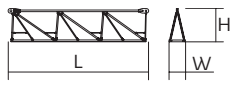
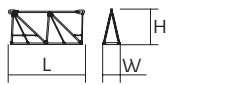
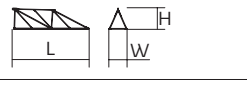
Slewing crane part:  213 ft -  50 LVF

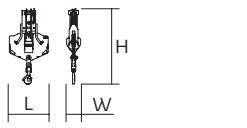
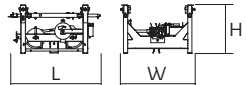
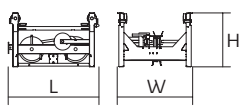
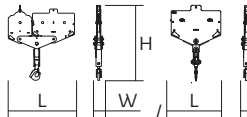

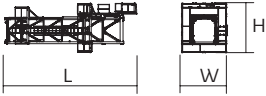
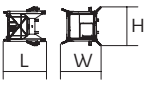
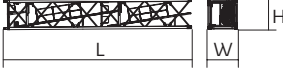
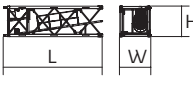
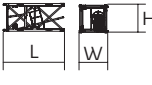
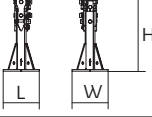
Slewing crane part		L (ft)	W (ft)	H (ft)	lb (+/- 5%)
Counter-jib	 (A) (B)	36.1 36.1	3.8 3.8	8.1 8.1	19,213 18,629
Towerhead + cab	 5.2 ft	15.6	7.5	8.3	17,372
Hoisting winch (+ rope)	 50 LVF 90 HPL™	10.6 10.6	8.1 10.8	6.2 5.8	7,319 9,092
Jib section	 ① 6 DVF	35.5	5.6	9	7,959
Jib section	 ② ④ ⑤ ⑥	33.8 33.5 33.6 33.4	3.9 3.9 3.9 3.9	7.9 7.8 6.9 6	5,335 3,439 2,723 1,753
Jib section	 ③ ⑦	17.3 16.7	3.9 3.9	7.8 5	2,116 683
Jib section	 ⑧	16.7	3.9	4.6	485
Trolley	 11 USt	6.1	5	3.4	882
Pulley block	 11 USt	3.3	1.4	6.6	694
Trolley	 11 USt	5.2	5	3.2	463
Trolley	 11 USt 5.5 USt	5.6 6.1	5 5	3.4 3.2	540 520
Pulley block	 11 USt 5.5 USt	5.4 3.6	0.7 0.5	5.6 4.9	717 430

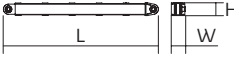
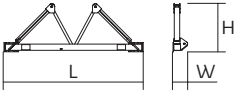
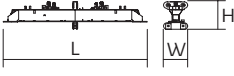
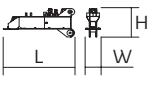
Crane tower			L (ft)	W (ft)	H (ft)	lb (+/- 5%)
Telescopic cage T 41		□ 5.2 ft	35.6	12.3	13.5	15,653
K40/K40-2		□ 5.2 ft	7.3	6.9	6.8	2,932
K 447E KM 447E KM 449E		□ 5.2 ft	33.5 33.5 33.5	5.3 5.3 5.3	5.3 5.3 5.3	7,474 7,088 8,830
K 447A KMT 447A K 449A KMT 449A		□ 5.2 ft	17.1 17.1 17.1 17.1	5.5 5.5 5.5 5.5	5.3 5.3 5.3 5.3	4,079 3,847 4,916 4,696
K 447C KMT 447C		□ 5.2 ft	11.3 11.6	5.5 5.5	5.3 5.3	2,998 2,976
Fixing angles		P 24A / P 42A	1.8	1.8	3.8	529
Basic mast unit		S 41A	11.9	6.4	6.8	7,132
Struts		S 41A	10.4	0.9	0.8	816
Half-bearer		S 41A	16.7	2	5.8	2,315
Cross girder		ZD 463	25.1	3.8	4.5	7,904
1/2 Cross girder		ZD 463	11.2	2.3	4.4	3,649

Mechanisms

480 V - 60 Hz											hp	kW			
	50 LVF 25 Optima	fpm	126	166	221	313	66	85	115	157	50	37	1,827 ft		
		USt	5.5	4.1	2.8	1.1	11	8.3	5.5	2.5					
	90 HPL™ 25	fpm	213	279	392	518	707	110	146	203	271	353	90	66	2,736 ft
		USt	5.5	4.1	2.8	1.4	0.4	11	8.3	5.5	2.8	1.3			
	6 DVF 4 Optima	fpm	0 → 164 (11 USt) 0 → 328 (6.6 USt) 0 → 394 (3.3 USt)									5.5	4		
	RVF 162 Optima+	rpm	0 → 0.9									2 x 7.5	2 x 5.5		

480 V (+6% -10%) 60 Hz	50 LVF: 58 → 38 kVA	
	90 HPL™: 90 → 54 kVA	

50 LVF 25 Optima

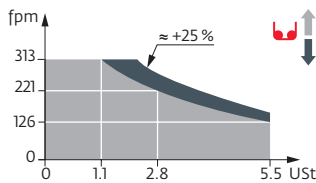

These mast combinations meet the EN 14439 and ASME B30.3-2016 specifications for “out of service” wind conditions, provided the illustrated wind speed matches required design wind speed for the location of the tower crane. The “out of service” design wind speed was determined in accordance with ASCE 7-10, Figure 26.5-1A. The wind velocity, used for this configuration was 98 mph (158 kph), which represents a nominal design 3-second wind gust at 33 ft (10 m) above ground for Exposure B category. A factor of 0.85 was applied to the 700-year ultimate design wind speed of 115 mph (185 kph), per ASCE 37-02, with the assumption that this crane is considered a temporary structure used during a construction period of 2 years or less.

- Jib elevation
- Standard equipment
- Options
- Potain Plus function: Plus load curves
- Hook heights with Plus load curves
- Reactions in service
- Reactions out of service
- Total ballast weight
- Jib weight
- Lorry 44 ft
- Container High Cube 40 ft, and/or Flat Rack 20 ft
- Hoisting
- Trolleying
- Slewing
- Travelling
- Required power
- Power Control Function: wind speeds adapted to the available power
- Consult us

This commercial document is not legally binding. For any technical information, please refer to the corresponding instructions.

