

Grove GMK5225 Tier III

Product Guide

ASME B30.5
Imperial 85%



Features

- 170 t (225 USt) capacity
- 13,7 m - 64 m (45 ft - 210 ft) six-section full power MEGAFORM™ boom with TWIN-LOCK™ pinning
- Chassis engine: Cummins QSX 15, six-cylinder, 399 kW (535 hp), torque 1873 ft/lb (1400 rpm). * Alternate engine: Mercedes-Benz OM 502 LA, eight-cylinder, 420 kW (563 hp)
- Superstructure engine: Cummins QSB 6.7, six-cylinder 164 kW (220 hp), torque 700 ft/lb (1500 rpm). *Alternate engine: Mercedes Benz OM 906 LA, six-cylinder, 170 kW (228 hp)
- Allison 4000 SP transmission

Features

MEGATRAK™

The MEGATRAK™ suspension system is the best off road driveline available on the market today. The system's versatility and performance allows the GMK5225 to operate as a true all-terrain crane. The MEGATRAK™ independent suspension and all-wheel steer system allows wheels to remain on the ground at all times so stresses and weight are not continually transferred between axles. MEGATRAK™ provides true ground clearance where others just raise the chassis.

Other benefits of the MEGATRAK™ system are:

- A reliable suspension system
- Excellent job site maneuverability with all-wheel steering
- Commonality among almost all models
- A driveline that remains aligned at all times
- A steering linkage system that is protected against damage
- Constant tire contact for equal tire wear
- Reduced maintenance



TWIN-LOCK™

Boom pinning mechanism automatically pins the sections in position using two horizontal pins.

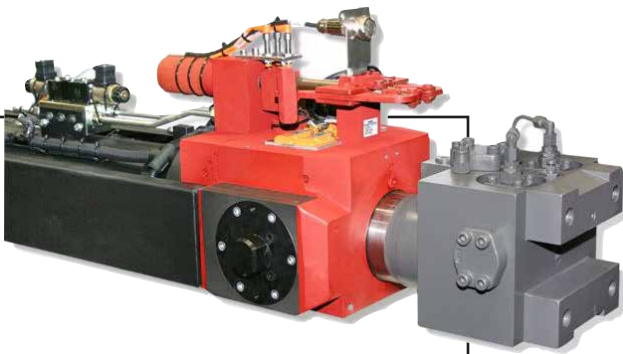

CraneSTAR

CraneSTAR is an exclusive and innovative crane asset management system that helps improve your profitability and reduce costs by remotely monitoring critical crane data. Visit www.cranestar.com for more information.

EKS 5

The EKS 5 monitors the lifting conditions of the crane at all times and provides a full graphic display, rear lighting, graphic of boom telescoping percentage, and load charts.

ECOS

Electronic Crane Operating System - ECOS enables control of the entire crane's principle operations. Simple programming eases lift planning and a supply of essential information allows full concentration on the lift itself.



Contents

Specifications	4
Dimensions	7
Weight proposals	8
Counterweight	10
Working range (main boom)	11
Load charts (main boom)	12
Working range (swingaway and inserts)	15
Load charts (hydraulically offsettable swingaway)	16
Load charts (manual offsettable swingaway)	19
Working range (heavy duty jib)	20
Load charts (heavy duty jib)	21
Symbols glossary	24
Notes	25

Specifications

Superstructure



Boom

13,7 m - 64 m (45 ft - 210 ft) six-section, full power MEGAFORM™ boom with patented TWIN-LOCK™ boom pinning system.

Maximum tip height: 67 m (220 ft).



Boom nose

Seven nylatron sheaves, mounted on heavy duty tapered roller bearings with removable pin-type rope guards. Quick reeve boom nose. Removable auxiliary boom nose with removable pin type rope guard.



Boom elevation

Single lift cylinder with safety valve provides boom angle from -1.5° to +83°.



Hydraulic offsettable lattice extension

11 m - 18 m (36 ft - 59 ft) bi-fold lattice swingaway extension hydraulically offsettable and luffing under load: 0° - 40°.

Controlled from the crane cab.

Maximum tip height: 85 m (279 ft)



*Manual offsettable lattice extension

11 m - 18 m (36 ft - 59 ft) bi-fold lattice swingaway extension manually offsettable 0°, 20° or 40°. Maximum tip height: 85 m (279 ft)



Lattice inserts

2 x 8 m (26 ft) inserts for use with lattice swingaway extension to increase length to 26 m (85 ft) or 34 m (112 ft).

Maximum tip height: 101 m (331 ft)



Load moment and anti-two block system

Load moment and anti-two block system with audio/visual warning and control lever lockout provides electronic display of boom angle, length, radius, tip height, relative load moment, maximum permissible load, load indication and warning of impending two-block condition.



Cab

All aluminum constructed cab with acoustical lining, hydraulic tilted to 20°. Includes tinted safety glass, adjustable operator's seat, opening windows at side and rear, hinged windshield with wiper, sun visor and window shade. Other features include, engine-dependent hot water heater/defroster, armrest integrated crane controls, and ergonomically arranged instrumentation.



Swing

Three planetary gear boxes with fixed displacement axial piston motors. Infinitely variable to 1.3 rpm. Free swing or hydrostatically engaged brake controlled by swing lever. Swing brake selected by foot operated switch.



Counterweight

53,1 t (117,000 lb) consisting of various sections with hydraulic installation/removal system. Controlled from the superstructure cab.



Engine - Cummins

Cummins QSB 6.7, six-cylinder

Horsepower: 164 kW (220 bhp) at 2200 rpm

Torque: 949 Nm (700 ft/lb) at 1500 rpm

Engine Emissions: EPA/CARB/EUROMOT Tier III (non-road).



*Engine - Mercedes-Benz

*Alternate engine: Mercedes-Benz OM 906 LA, six-cylinder

Horsepower: 170 kW (228 bhp) at 2200 rpm

Torque: 810 Nm (597 ft/lb) at 1200 rpm

Engine Emissions: EPA/CARB/EUROMOT Tier III (non-road).



Fuel tank capacity

240 L (63 gal)



Electrical system

3 phase alternator: 28V/80A

2 batteries: 12V/170Ah



Hydraulic system

2 separate circuits, 1 axial piston variable displacement pump (load sensing) with electronic power limiting control and 1 double gear pump for slewing. Thermostatically controlled oil coolers keep oil at optimum operating temperature. Hydraulic tank capacity: 915 L (242 gal)

Specifications

Superstructure continued



Hoist

Main and auxiliary hoists are powered by axial piston motor with planetary gear and brake. "Thumb-thumper" hoist drum rotation indicator alerts operator of hoist movement.

	Main	Auxiliary
Rope length:	290 m (951 ft)	290 m (951 ft)
Rope diameter:	22 mm	22 mm
Line speed:	125m/min (410 fpm)	125 m/min (410 fpm)
Line pull:	93.0 kN (20,907 lb)	93.0 kN (20,907 lb)

*Optional hook blocks

Lifting capacity	Sheaves	Weight	Parts of line	Possible load with the crane
200 t (220 USt)	9	2400 kg (5291 lb)	2-16	140 t* (154 USt*)
160 t (176 USt)	7	1750 kg (3858 lb)	2-15	135 t (182 USt)
125 t (138 USt)	5	1650 kg (3638 lb)	2-11	100 t (110 USt)
80 t (88 USt)	3	950 kg (2094 lb)	1-7	65 t (72 USt)
32 t** (35 USt)	1	600 kg (1323 lb)	1-3	28 t (31 USt)
12 t*** (13.2 USt)	H/B	300 kg (661 lb)	1	9,5 t (10.5 USt)

* Requires additional boom nose sheave

** Required for overhaul of single part line with boom/jib lengths in excess of 64 m (210 ft)

*** Overhaul weight designed for a maximum of 64 m (210 ft) boom/jib lengths

*Optional equipment

- ▶ 3,6 m (11.8 ft) side-stowed 3-sheave integrated heavy duty jib
- ▶ Work lights, mounted on boom base section
- ▶ Radio/CD player for superstructure cab
- ▶ Stainless steel exhaust system with spark arrestor
- ▶ Air conditioning
- ▶ Hook blocks/headache ball
- ▶ Engine independent diesel cab heater, with engine pre-heater including 24-hour timer
- ▶ Engine independent propane gas cab heater
- ▶ Additional cab mounted work light
- ▶ Strobe light
- ▶ Working range limiter
- ▶ Data logger
- ▶ Camera system for boom head
- ▶ Camera system for hoists
- ▶ EKS5 Light with semi-graphic display

Carrier



Chassis

Box type, torsion resistant frame is fabricated from high strength steel.



Outrigger system

Four hydraulic two-stage outrigger beams with vertical cylinders and outrigger pads, 600 mm (23.6 in) square. Outriggers can be set in four positions:

Full	7,8 m (25.6 ft)
Partial	6,0 m (19.6 ft)
	4,4 m (14.3 ft)
Retracted	2,8 m (9.1 ft)

Independent horizontal and vertical movement controlled from each side of carrier and from the operator's cab. Electronic crane level indicator with automatic leveling system. Includes outrigger monitoring system.



Transmission

Allison 4000 SP. 6 speeds forward, 1 reverse
2 speed transfer case



Drive/steer

10x6x10



Tires

10 tires, 445/95 R 25 (16.00 R25)
(vehicle width - 3,0 m [9.8 ft])

Specifications

Carrier continued

Axles

1st axle line – steer
2nd axle line – steer (optional drive)
3rd axle line – drive/steer (permanent drive with 10x6, disconnects for highway with 10x8)
4th axle line – drive/steer (connects for all wheel steer)
5th axle line – drive/steer
Drive axles with planetary hub reduction and center mounted differential-gearing. Inter-axle and cross axle differential locks.

Suspension

Grove exclusive MEGATRAK™ suspension. Independent hydro-pneumatic system acting on all wheels with hydraulic lockout. Suspension can be raised 160 mm (6.3 in) or lowered 120 mm (4.7 in) both longitudinally and transversely. Features an automatic leveling system for highway travel.

Steering

Dual circuit, hydraulic power assisted steering system. Transfer case mounted, ground driven emergency steering pump. Axles 1, 2, 3 and 5 steer on highway (steer by wire). Separate steering of the 4th and 5th axles for all wheel and crab steering, controlled by an electronic rocker switch.

Engine - Cummins

Cummins QSX 15, six-cylinder
Horsepower: 399 kW (535 bhp) at 2100 rpm
Torque: 2539 Nm (1873 ft/lb) at 1400 rpm: EPA/Engine
Emissions: EPA/CARB/EUROMOT Tier III (non-road).

*Engine - Mercedes-Benz

*Alternate engine: Mercedes-Benz OM 502 LA, eight-cylinder
Horsepower: 420 kW (563 bhp) at 1800 rpm
Torque: 2700 Nm (1991 ft/lb) at 1300 rpm
Engine Emissions: EPA/CARB/EUROMOT Tier III (non-road).

Fuel tank capacity

360 L (95 gal)

Brakes

Service brakes: pneumatic dual circuit acting on all wheels air dryer. Parking brake: pneumatically operated spring loaded brake acting on axle lines 2, 3, 4 and 5.

Cab

Two-man aluminum construction with the following features: safety glass, driver seat with pneumatic suspension, engine-dependent hot water heater, heated rear view mirrors, complete instrumentation and driving controls.

Electrical system

24V system with three phase alternator, 28V/100A
2 batteries, 12V/170 Ah

Maximum speed

85 km/h (53 mph)

Gradeability (theoretical)

50% - 14.00 tires
45% - 16.00 / 20.5 tires

Miscellaneous standard equipment

Work light, tool kit; fire extinguishers; auxiliary boom nose, radio/CD player in carrier cab, heated rear view mirrors, wind speed indicator, working light for each outrigger beam, CraneSTAR asset management system.

*Optional equipment

- ▶ Stainless steel exhaust system with spark arrestor
- ▶ Air conditioning
- ▶ 385/95 R25 tires (14.00 R25) (vehicle width 3,0 m [9.8 ft])
- ▶ 525/80 R25 tires (20.5 R25) (vehicle width 3,1 m [10.2 ft])
- ▶ 10x8x10 drive/steer
- ▶ Transmission retarder (in lieu of engine compression brake)
- ▶ Engine independent diesel cab heater, with engine pre-heater, including 24 hour timer
- ▶ Engine independent propane gas cab heater
- ▶ Engine shutdown valve (for both engines)
- ▶ Reversing camera system
- ▶ Wireless remote control
- ▶ Rear mounted stowage box
- ▶ Outrigger pad load indicator
- ▶ Trailer hitch
- ▶ Steel outrigger pads
- ▶ Strobe light
- ▶ Spare tire

Dimensions

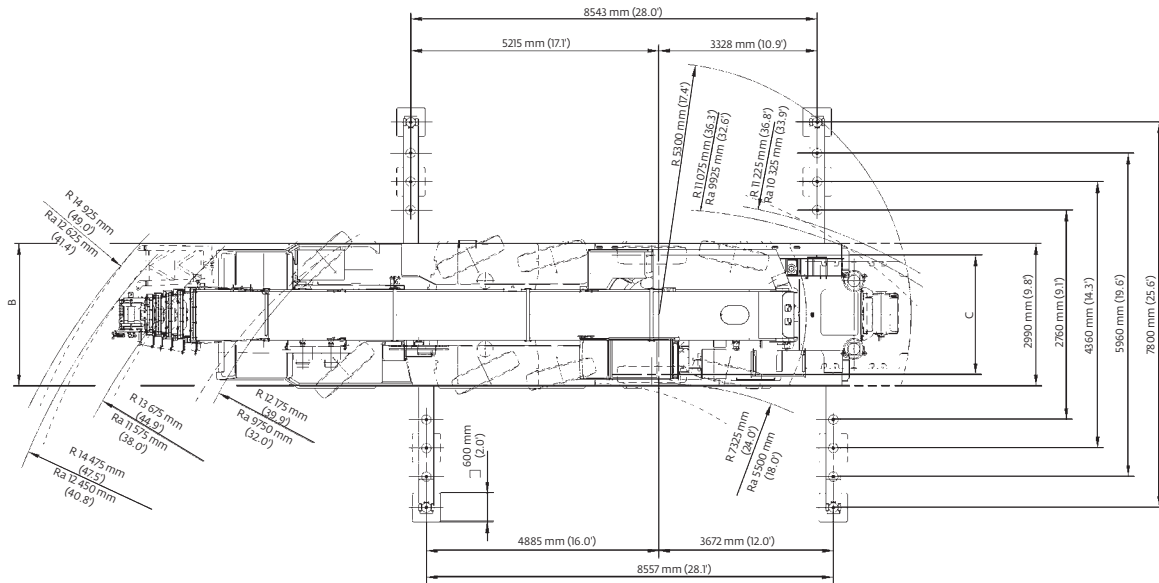
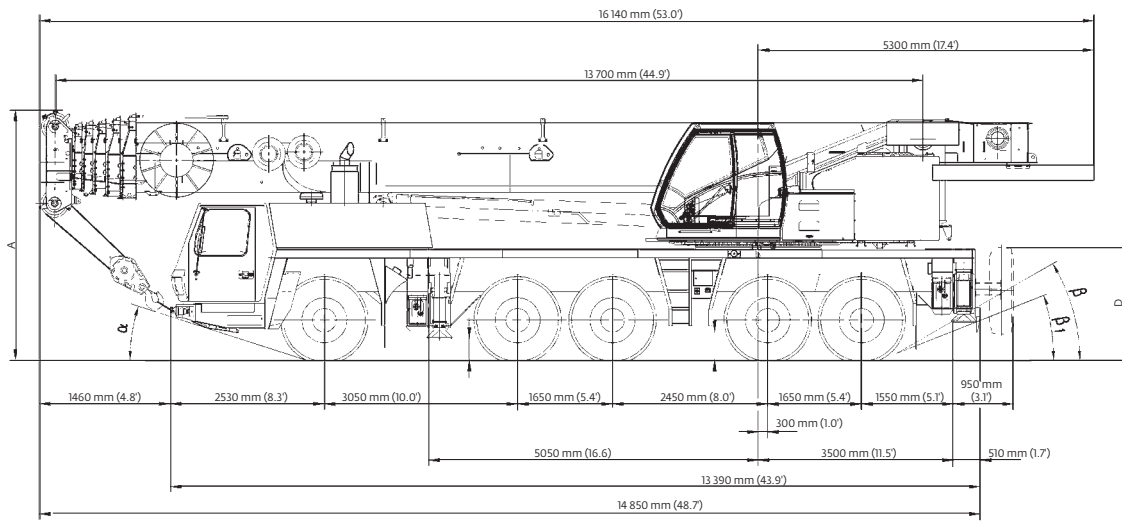

	A	A 130 mm (5.4")*	B	C	D	E	F	α	β	β1
14.00 R25	3950 mm (13.0')	3820 mm (12.5')	3000 mm (9.8')	2548 mm (8.4')	1760 mm (5.8')	400 mm (1.3')	244 mm (.08')	18°	23°	17°
16.00 R25	4000 mm (13.1')	3870 mm (12.7')	3000 mm (9.8')	2486 mm (8.2')	1810 mm (5.9')	450 mm (1.5')	295 mm (1.0')	20°	25°	19°
20.5 R25	4000 mm (13.1')	3870 mm (12.7')	3100 mm (10.2')	2507 mm (8.2')	1810 mm (5.9')	450 mm (1.5')	295 mm (1.0')	20°	25°	19°

Ra = Radius all wheels steered
*Lowered

Weight proposals Cummins

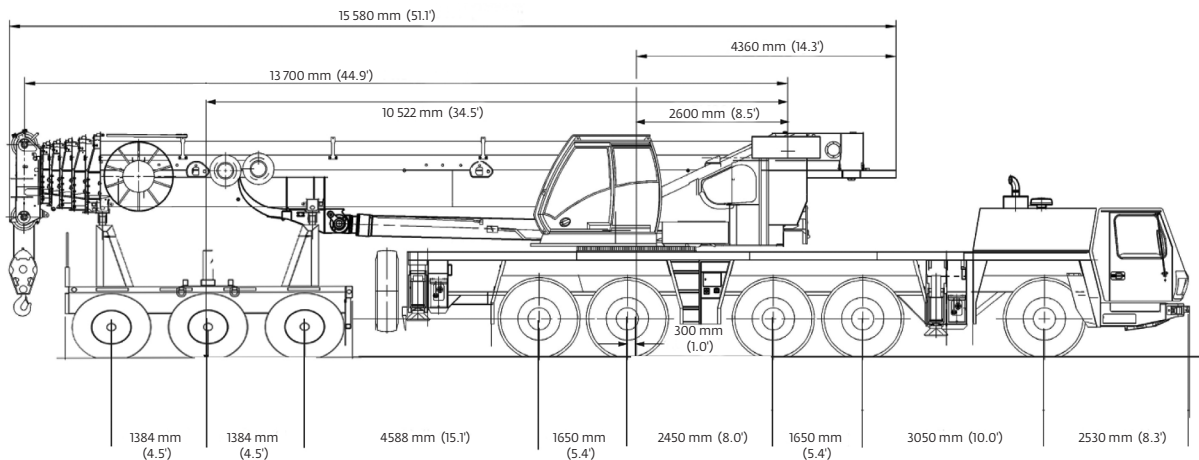

Basic weights - kg (lb)	Axles 1 - 3		Axles 4 and 5		3 Dolly axles		Total	
GMK 5225 Cummins Tier III power with: 20.50 R25 tires, 10x8x10 drive/steer, 36 ft - 59 ft hydraulic luffing swingaway, 2nd oil cooler, outrigger pads, auxiliary hoist, driver and tanks filled, 3 axle boom dolly 4128 kg (9100 lb).	30 787	(67,874)	17 521	(38,627)	17 554	(38,700)	65 862	(145,201)
Additions:								
5000 kg (11,000 lb) section pinned to superstructure (special counterweight version)	4845	(10,681)	155	(342)	0	(0)	5000	(11,023)
11 000 kg (24,250 lb) base section stowed on carrier	10 659	(23,499)	341	(752)	0	(0)	11 000	(24,251)
Removals:								
Brackets for hydraulic swingaway	-15	(-33)	-7	(-15)	-64	(-141)	-86	(-190)
Hose reel + parts for hydraulic swingaway	-56	(-123)	-25	(-55)	-129	(-284)	-210	(-463)
11 m - 18 m (36 ft - 59 ft) hydraulic swingaway	-206	(-454)	-92	(-203)	-1185	(-2612)	-1483	(-3269)
Front outriggers	-2016	(-4445)	256	(564)	0	(0)	-1760	(-3880)
Rear outriggers	926	(2041)	-3029	(-6678)	0	(0)	-2103	(-4636)
Front and rear outrigger floats	-70	(-154)	-130	(-287)	0	(0)	-200	(-441)
Substitutions:								
10x6x10 drive/steer	-337	(-743)	-38	(-84)	0	(0)	-375	(-827)
14.00R25 tires	-730	(-1609)	-300	(-661)	0	(0)	-1030	(-2271)
16.00R25 tires	-305	(-672)	-125	(-276)	0	(0)	-430	(-948)

Boom over front (Cummins)								
Basic weights - kg (lb)	Axles 1 - 3		Axles 4 and 5		Total			
Cummins Tier III power, 16.00 R25 tires, 10x6x10 drive/steer, 2nd oil cooler, outrigger pads, auxiliary hoist, driver and tanks filled	34 422	(75,888)	24 731	(54,523)	59 153	(130,410)		
Additions:								
10x8x10 drive/steer	337	(743)	38	(84)	375	(827)		
Transmission integrated retarder	52	(115)	-12	(-26)	40	(88)		
Spare wheel 14.00 R25 XGC steel rim with stowage	-134	(-295)	373	(822)	239	(527)		
Spare wheel 16.00 R25 XGC steel rim with stowage	-166	(-366)	461	(1016)	295	(650)		
Spare wheel 20.5 R25 XGC steel rim with stowage	-192	(-423)	534	(1177)	342	(754)		
Brackets for hydraulic swingaway	101	(223)	-15	(-33)	86	(190)		
Hose reel + parts for hydraulic swingaway	195	(430)	15	(33)	210	(463)		
11 m - 18 m (36 ft - 59 ft) hydraulic swingaway	1906	(4202)	-423	(-933)	1483	(3269)		
11 000 kg (24,250 lb) base plate stowed on carrier	10 660	(23,501)	340	(750)	11 000	(24,251)		
5000 kg (11,000 lb) slab fixed to turntable (special counterweight version)	-2759	(-6083)	7759	(17,106)	5000	(11,023)		
Substitutions:								
14.00R25 tires	-361	(-796)	-241	(-531)	-602	(-1327)		
20.5R25 tires	257	(567)	172	(379)	429	(946)		
Removals:								
Boom assembly w/o lift cylinder	-17 659	(-38,931)	-964	(-2125)	-18 622	(-41,054)		
Front outriggers	-2016	(-4445)	256	(564)	-1760	(-3880)		
Rear outriggers	926	(2041)	-3029	(-6678)	-2103	(-4636)		
Front and rear outrigger floats	70	(154)	130	(287)	200	(441)		

Weight proposals Mercedes-Benz

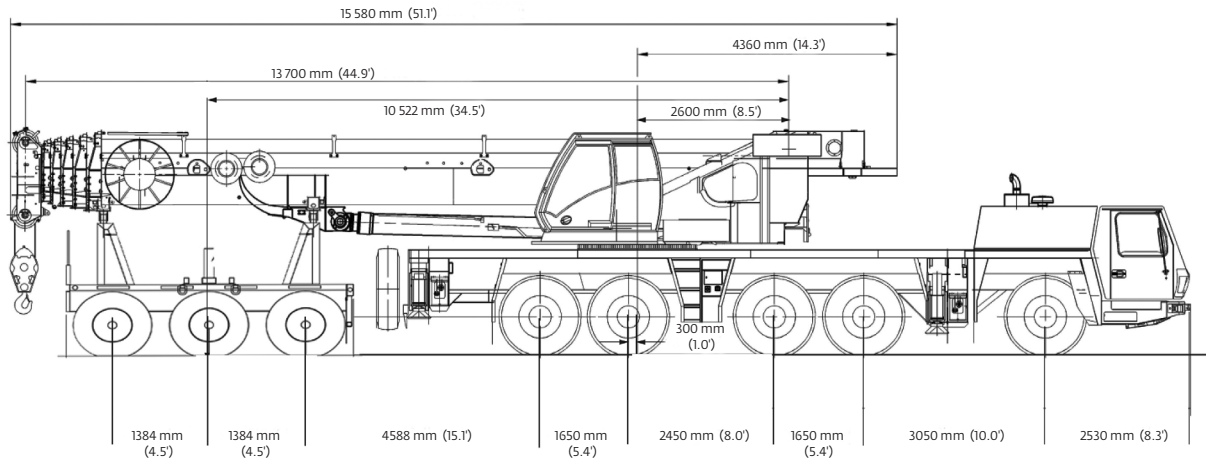

Basic weights - kg (lb)	Axles 1 - 3		Axles 4 and 5		3 Dolly axles		Total	
GMK 5225 Mercedes-Benz Tier III power with: 20.50 R25 tires, 10x8x10 drive/steer, 36 ft - 59 ft hydraulic luffing swingaway, 2nd oil cooler, outrigger pads, auxiliary hoist, driver and tanks filled, 3 axle boom dolly 4128 kg (9100 lb)	29 954	(66,037)	17 751	(39,134)	17 554	(38,700)	65 260	(143,874)
Additions:								
5000 kg (11 000 lb) section pinned to superstructure (special counterweight version)	4845	(10,681)	155	(342)	0	(0)	5000	(11,023)
11 000 kg (24,250 lb) base section stowed on carrier	10 659	(23,499)	341	(752)	0	(0)	11 000	(24,251)
Removals:								
Brackets for hydraulic swingaway	- 15	(-33)	- 7	(-15)	- 64	(-141)	- 86	(-190)
Hose reel + parts for hydraulic swingaway	- 56	(-123)	- 25	(-55)	- 129	(-284)	- 210	(-463)
11 m - 18 m (36 ft - 59 ft) hydraulic swingaway	- 206	(-454)	- 92	(-203)	- 1185	(-2612)	- 1483	(-3269)
Front outriggers	- 2016	(-4445)	256	(564)	0	(0)	- 1760	(-3880)
Rear outriggers	926	(2041)	- 3029	(-6678)	0	(0)	- 2103	(-4636)
Front and rear outrigger floats	- 70	(-154)	- 130	(-287)	0	(0)	- 200	(-441)
Substitutions:								
10x6x10 drive/steer	- 337	(-743)	- 38	(-84)	0	(0)	- 375	(-827)
14.00R25 tires	- 730	(-1609)	- 300	(-661)	0	(0)	- 1030	(-2271)
16.00R25 tires	- 305	(-672)	- 125	(-276)	0	(0)	- 430	(-948)

Boom over front (Mercedes)								
Basic weights-kg (lb)	Axles 1 - 3		Axles 4 and 5		Total			
Mercedes-Benz Tier III power, 16.00 R25 tires, 10x6x10 drive/steer, 2nd oil cooler, outrigger pads, auxiliary hoist, driver and tanks filled	33 330	(73,480)	25 220	(55,601)	58 551	(129,083)		
Additions:								
10x8x10 drive/steer	337	(743)	38	(84)	375	(827)		
Transmission integrated retarder	52	(115)	- 12	(-26)	40	(88)		
Spare wheel 14.00 R25 XGC steel rim with stowage	- 134	(-295)	373	(822)	239	(527)		
Spare wheel 16.00 R25 XGC steel rim with stowage	- 166	(-366)	461	(1016)	295	(650)		
Spare wheel 20.5 R25 XGC steel rim with stowage	- 192	(-423)	534	(1177)	342	(754)		
Brackets for hydraulic swingaway	101	(223)	- 15	(-33)	86	(190)		
Hose reel + parts for hydraulic swingaway	195	(430)	15	(33)	210	(463)		
11 m-18 m (36 ft - 59 ft) hydraulic swingaway	1906	(4202)	- 423	(-933)	1483	(3269)		
11 000 kg (24,250 lb) base plate stowed on carrier	10 660	(23,501)	340	(750)	11 000	(24,251)		
5000 kg (11,000 lb) slab fixed to turntable (special counterweight version)	- 2759	(-6083)	7759	(17,106)	5000	(11,023)		
Substitutions:								
14.00R25 tires	- 361	(-796)	- 241	(-531)	- 602	(-1327)		
20.5R25 tires	257	(567)	172	(379)	429	(946)		
Removals:								
Boom assembly w/o lift cylinder	- 17 659	(-38,931)	- 964	(-2125)	- 18 622	(-41,054)		
Front outriggers	- 2016	(-4445)	256	(564)	- 1760	(-3880)		
Rear outriggers	926	(2041)	- 3029	(-6678)	- 2103	(-4636)		
Front and rear outrigger floats	70	(154)	130	(287)	200	(441)		

Counterweight

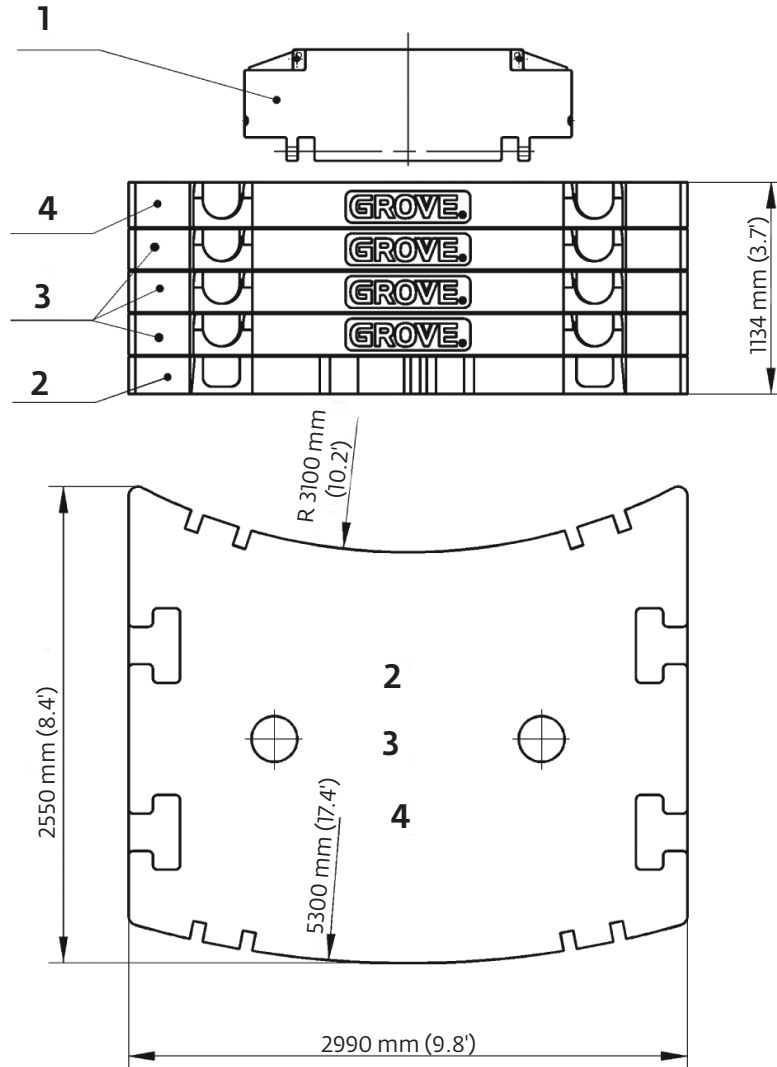

1. 2000 kg (4409 lb) Bolted (Auxiliary Hoist or IPO)
2. 11 000 kg (24,251 lb) Baseplate
3. 10 000 kg (22,046 lb) Stacking
4. 10 000 kg (22,046 lb) Stacking

	1	2	3	4
Counterweight Configuration kg (lb)				
2100 (4600)	●			
13 100 (28,800)	●	●		
23 100 (50,900)	●	●	●	
33 100 (72,900)	●	●	2●	
43 100 (95,000)	●	●	3●	
53 100 (117,000)	●	●	3●	●

Working range

13,7 m - 64 m (45 ft - 210 ft) main boom

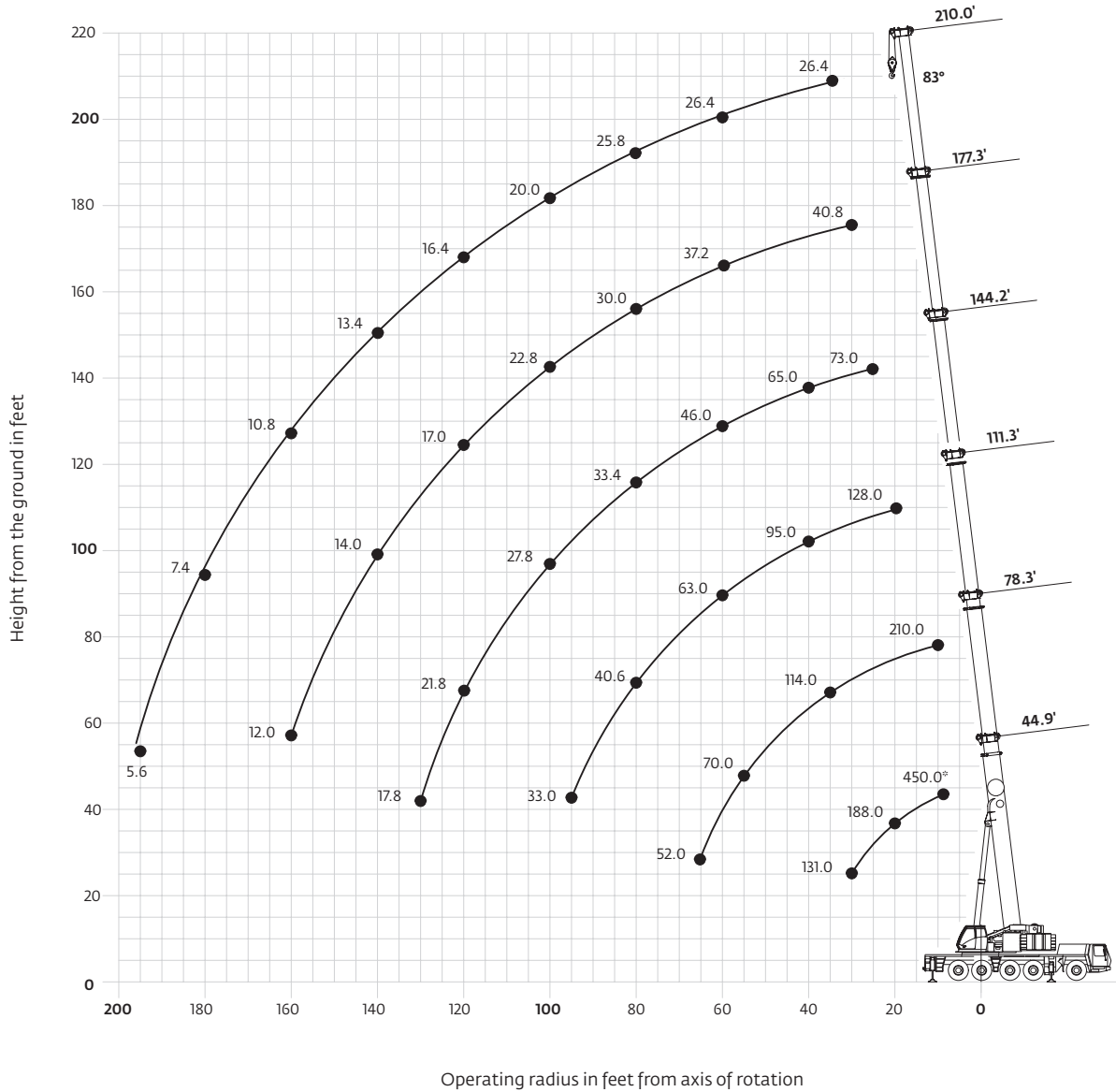

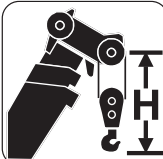
	Hook block (UST)	H
	200D	3650 mm (12.0 ft)
160D	3650 mm (12.0 ft)	
125D	3300 mm (10.8 ft)	
80D	3300 mm (10.8 ft)	
32E	3200 mm (10.5 ft)	
12 H/B	2450 mm (8.0 ft)	

*Over rear







Hook heights shown in the working range diagram do not consider loaded boom deflection.

THIS CHART IS ONLY A GUIDE AND SHOULD NOT BE USED TO OPERATE THE CRANE.







The individual crane's load chart, operating instructions and other instructional plates must be read and understood prior to operating the crane

Load charts

Main boom

    											
13,7 m - 64 m (44.9 ft - 210 ft) 53 100 kg (117,000 lb) 28.1 ft x 25.6 ft spread (100%) 360°											
  Pounds x 1000											
Feet	44.9	61.7	78.3	94.8	111.3	127.5	144.2	160.8	177.3	193.8	210.0
8.0	450.0*										
9.0	310.0*										
10.0	286.0	236.0	210.0	172.0							
15.0	234.0	217.0	189.0	169.0	128.0						
20.0	188.0	188.0	171.0	153.0	128.0	97.0	73.0				
25.0	157.0	159.0	153.0	142.0	126.0	97.0	73.0	55.0			
30.0	131.0	135.0	132.0	131.0	115.0	93.0	73.0	55.0	40.8	32.2	
35.0		117.0	114.0	115.0	105.0	87.0	71.0	54.0	40.8	32.2	26.4
40.0		103.0	100.0	101.0	95.0	80.0	65.0	53.0	40.8	32.2	26.4
45.0		88.0	90.0	89.0	88.0	75.0	59.0	51.0	40.8	32.2	26.4
50.0			79.0	78.0	80.0	70.0	54.0	48.0	40.2	32.2	26.4
55.0			70.0	68.0	70.0	66.0	50.0	45.0	39.0	32.2	26.4
60.0			62.0	60.0	63.0	61.0	46.0	42.0	37.2	32.2	26.4
65.0			52.0	55.0	56.0	57.0	41.6	39.4	35.4	31.2	26.4
70.0				51.0	49.0	51.0	38.8	36.8	33.8	30.0	26.4
75.0				46.0	44.0	46.0	36.0	34.2	32.0	28.8	26.4
80.0					40.6	41.8	33.4	32.0	30.0	27.6	25.8
85.0					38.4	37.8	31.6	29.8	28.0	26.6	24.4
90.0					36.2	34.4	30.2	28.0	26.2	25.2	23.0
95.0					33.0	31.2	29.0	26.2	24.6	23.8	21.4
100.0						28.4	27.8	24.6	22.8	22.0	20.0
105.0						26.0	26.6	23.2	20.4	19.8	19.0
110.0						23.8	25.6	21.4	19.2	18.6	18.2
115.0							23.6	19.8	18.2	17.6	17.2
120.0							21.8	18.2	17.0	16.6	16.4
125.0							20.0	16.8	16.2	15.6	15.6
130.0							17.8	16.2	15.2	14.8	14.8
135.0								15.6	14.6	14.0	14.0
140.0								15.2	14.0	13.2	13.4
145.0									13.4	12.6	12.6
150.0									13.0	11.6	12.0
155.0									12.6	11.0	11.4
160.0									12.0	10.4	10.8
165.0										10.0	9.8
170.0										9.6	9.0
175.0										9.2	8.2
180.0											7.4
185.0											6.8
190.0											6.2
195.0											5.6

* Over the rear with special equipment





    											
13,7 m - 64 m (44.9 ft - 210 ft) 43 100 kg (95,000 lb) 28.1 ft x 25.6 ft spread (100%) 360°											
  Pounds x 1000											
Feet	44.9	61.7	78.3	94.8	111.3	127.5	144.2	160.8	177.3	193.8	210.0
10.0	286.0	236.0	210.0	172.0							
15.0	230.0	217.0	189.0	169.0	128.0						
20.0	185.0	186.0	171.0	153.0	128.0	97.0	73.0				
25.0	154.0	155.0	152.0	142.0	126.0	97.0	73.0	55.0			
30.0	131.0	132.0	129.0	131.0	115.0	93.0	73.0	55.0	40.8	32.2	
35.0	157.0	114.0	111.0	112.0	105.0	87.0	71.0	54.0	40.8	32.2	26.4
40.0	131.0	97.0	97.0	94.0	93.0	80.0	65.0	53.0	40.8	32.2	26.4
45.0		83.0	83.0	80.0	79.0	75.0	59.0	51.0	40.8	32.2	26.4
50.0			71.0	70.0	68.0	68.0	54.0	48.0	40.2	32.2	26.4
55.0			63.0	63.0	59.0	60.0	50.0	45.0	39.0	32.2	26.4
60.0			56.0	55.0	54.0	53.0	46.0	42.0	37.2	32.2	26.4
65.0			49.0	48.0	50.0	48.0	41.6	39.4	35.4	31.2	26.4
70.0				43.2	45.0	42.8	38.8	36.8	33.8	30.0	26.4
75.0				40.4	40.4	38.6	35.6	34.2	32.0	28.8	26.4
80.0					36.4	34.6	33.2	31.2	30.0	27.6	25.8
85.0					32.8	31.0	31.6	28.2	28.0	26.6	24.4
90.0					29.8	28.0	29.6	25.6	25.6	25.2	23.0
95.0					27.0	26.2	27.0	23.2	23.4	23.6	21.4
100.0						25.2	24.6	21.4	21.2	21.6	20.0
105.0						24.0	22.4	19.6	19.4	19.8	19.0
110.0						22.2	20.4	18.8	18.0	18.0	18.2
115.0							18.6	18.2	17.2	16.6	17.2
120.0							17.0	17.4	16.6	15.4	15.8
125.0							15.6	16.4	15.8	14.6	14.6
130.0							14.6	15.2	15.2	13.8	13.4
135.0								14.0	14.0	13.2	12.2
140.0								12.8	13.0	12.4	11.2
145.0									11.8	11.4	10.0
150.0									11.0	10.4	9.0
155.0									10.0	9.4	8.2
160.0									9.2	8.6	7.4
165.0										7.8	6.6
170.0										7.0	5.8
175.0										6.4	5.0
180.0											4.4
185.0											3.8
190.0											3.2
195.0											2.8



THIS CHART IS ONLY A GUIDE AND SHOULD NOT BE USED TO OPERATE THE CRANE.

The individual crane's load chart, operating instructions and other instructional plates must be read and understood prior to operating the crane





Load charts



Main boom

 13.7 m - 64 m
(44.9 ft - 210 ft)
 
 33 100 kg
(72,900 lb)
 
 28.1 ft x 25.6 ft spread
(100%)
 
 360°



 Pounds x 1000

Feet	44.9	61.7	78.3	94.8	111.3	127.5	144.2	160.8	177.3	193.8	210.0
10.0	286.0	236.0	210.0	172.0							
15.0	224.0	217.0	189.0	169.0	128.0						
20.0	181.0	182.0	171.0	153.0	128.0	97.0	73.0				
25.0	151.0	152.0	149.0	142.0	126.0	97.0	73.0	55.0			
30.0	125.0	127.0	125.0	117.0	114.0	93.0	73.0	55.0	40.8	32.2	
35.0		105.0	102.0	94.0	92.0	87.0	71.0	54.0	40.8	32.2	26.4
40.0		84.0	84.0	82.0	76.0	76.0	65.0	53.0	40.8	32.2	26.4
45.0		69.0	73.0	70.0	70.0	65.0	59.0	51.0	40.8	32.2	26.4
50.0			61.0	60.0	60.0	56.0	52.0	48.0	40.2	32.2	26.4
55.0			53.0	54.0	53.0	49.0	45.0	43.8	39.0	32.2	26.4
60.0			45.0	48.0	47.0	43.0	41.8	38.6	37.2	32.2	26.4
65.0			39.6	42.6	41.6	38.2	38.8	34.0	33.8	31.2	26.4
70.0				37.6	36.6	34.0	34.8	30.2	30.0	30.0	26.4
75.0				33.6	32.6	32.0	31.4	27.8	27.6	27.0	26.4
80.0					29.0	30.2	28.4	26.4	26.0	25.4	24.8
85.0					26.0	27.8	25.6	25.0	24.6	23.6	22.4
90.0					23.8	25.2	23.2	23.6	23.2	22.0	20.2
95.0					22.8	22.8	20.8	21.6	21.2	20.2	18.2
100.0						20.6	18.8	19.8	19.4	18.4	16.6
105.0							18.8	17.8	17.8	16.8	15.0
110.0							17.2	17.2	16.4	15.4	13.6
115.0								16.2	15.6	14.8	12.2
120.0								15.0	14.8	13.8	11.2
125.0								13.6	13.6	12.8	11.6
130.0								12.6	12.4	11.6	10.4
135.0									11.4	10.6	9.4
140.0									10.4	9.6	8.4
145.0										8.6	7.6
150.0										7.8	6.6
155.0										7.0	5.8
160.0										6.2	5.2
165.0											4.4
170.0											3.8
175.0											3.2
											2.0

 13.7 m - 64 m
(44.9 ft - 210 ft)
 
 23 100 kg
(50,900 lb)
 
 28.1 ft x 25.6 ft spread
(100%)
 
 360°



 Pounds x 1000

Feet	44.9	61.7	78.3	94.8	111.3	127.5	144.2	160.8	177.3	193.8	210.0
10.0	284.0	236.0	210.0	172.0							
15.0	220.0	217.0	189.0	169.0	128.0						
20.0	177.0	178.0	171.0	153.0	128.0	97.0	73.0				
25.0	142.0	144.0	137.0	124.0	119.0	97.0	73.0	55.0			
30.0	109.0	111.0	103.0	100.0	91.0	90.0	73.0	55.0	40.8	32.2	
35.0		88.0	86.0	80.0	79.0	73.0	67.0	54.0	40.8	32.2	26.4
40.0		70.0	70.0	69.0	66.0	60.0	56.0	53.0	40.8	32.2	26.4
45.0		59.0	58.0	59.0	56.0	51.0	51.0	45.0	40.8	32.2	26.4
50.0			50.0	51.0	48.0	44.0	44.0	38.6	38.0	32.2	26.4
55.0			44.0	44.0	41.4	40.8	38.4	35.2	35.2	32.2	26.4
60.0			37.8	38.2	36.2	37.0	33.6	33.0	33.0	31.4	26.4
65.0			33.0	33.2	31.8	32.8	29.6	29.8	29.2	27.8	25.6
70.0				29.0	29.4	29.4	27.2	27.4	26.8	24.6	22.6
75.0				25.6	27.6	26.2	25.6	25.4	24.0	22.0	20.0
80.0					24.6	23.6	23.8	23.0	21.6	19.6	17.8
85.0					22.0	21.0	21.4	20.8	19.4	17.6	15.8
90.0					19.8	18.6	19.4	18.8	17.4	15.8	14.0
95.0					17.8	17.6	17.6	17.0	15.8	14.2	12.4
100.0						16.8	16.2	15.4	14.2	12.6	11.0
105.0						15.0	14.6	14.0	12.8	11.4	9.6
110.0							13.6	13.2	12.6	11.6	10.2
115.0								11.8	11.2	10.4	9.0
120.0								10.8	10.2	9.4	8.0
125.0								9.6	9.0	8.2	7.0
130.0								8.8	8.0	7.2	6.2
135.0									7.2	6.4	5.2
140.0									6.4	5.6	4.4
145.0										4.8	3.6
150.0										4.0	3.0
155.0										3.4	2.4
160.0										2.8	

Load charts

Main boom

13.7 m - 64 m
(44.9 ft - 210 ft)

13 100 kg
(28,800 lb)

28.1 ft x 25.6 ft spread
(100%)

360°



Pounds x 1000

Feet	44.9	61.7	78.3	94.8	111.3	127.5	144.2	160.8	177.3	193.8	210.0
10.0	278.0	236.0	210.0	172.0							
15.0	216.0	215.0	189.0	169.0	128.0						
20.0	168.0	170.0	153.0	136.0	126.0	97.0	73.0				
25.0	120.0	120.0	111.0	101.0	98.0	89.0	73.0	55.0			
30.0	83.0	88.0	83.0	82.0	75.0	69.0	64.0	55.0	40.8	32.2	
35.0		69.0	66.0	65.0	60.0	57.0	55.0	48.0	40.8	32.2	26.4
40.0		54.0	56.0	53.0	50.0	50.0	45.0	43.8	38.6	32.2	26.4
45.0		44.0	47.0	45.0	41.8	42.0	38.2	38.6	37.0	31.6	26.4
50.0			38.8	38.0	38.6	35.8	35.4	34.0	32.0	29.6	26.4
55.0			32.6	32.6	33.4	31.0	30.8	29.6	27.8	25.4	23.2
60.0			28.4	29.2	29.2	28.4	26.8	25.8	24.2	22.0	19.8
65.0			24.2	26.2	25.6	25.6	23.6	22.6	21.2	19.2	17.2
70.0				22.8	22.6	22.8	20.8	20.0	18.6	16.8	14.8
75.0				20.0	19.8	20.2	18.4	17.6	16.4	14.6	12.6
80.0					18.0	18.0	16.4	15.6	14.4	14.6	10.8
85.0					15.8	16.0	14.6	13.8	12.6	11.0	9.2
90.0					14.0	14.2	13.0	12.4	11.2	9.6	7.8
95.0					12.4	12.4	11.4	11.0	9.8	8.2	6.6
100.0						11.0	10.0	9.6	8.6	7.0	5.4
105.0							9.8	8.8	8.6	7.4	6.0
110.0							8.6	7.6	7.4	6.4	5.0
115.0								6.6	6.4	5.4	4.0
120.0								5.6	5.4	4.6	3.2
125.0								4.8	4.6	3.8	2.4
130.0								4.0	3.8	3.0	
135.0									3.2	2.4	
140.0										2.4	

13.7 m - 64 m
(44.9 ft - 210 ft)

2100 kg
(4600 lb)

28.1 ft x 25.6 ft spread
(100%)

360°



Pounds x 1000

Feet	44.9	61.7	78.3	94.8	111.3	127.5	144.2	160.8	177.3	193.8	210.0
10.0	272.0	236.0	210.0	172.0							
15.0	206.0	206.0	185.0	156.0	128.0						
20.0	134.0	124.0	112.0	105.0	95.0	84.0	73.0				
25.0	83.0	85.0	81.0	75.0	68.0	66.0	59.0	51.0			
30.0	56.0	61.0	60.0	56.0	56.0	51.0	49.0	44.0	38.6	32.2	
35.0		47.0	47.0	46.0	44.0	43.0	40.2	37.4	34.8	31.6	26.4
40.0		36.0	38.0	38.0	35.8	35.2	33.0	30.8	28.4	25.8	23.0
45.0		28.2	31.0	31.4	30.4	29.4	27.6	25.6	23.6	21.2	18.6
50.0			25.6	26.2	25.6	24.8	23.2	21.4	19.8	17.6	15.2
55.0			21.0	22.2	21.8	21.0	19.6	18.0	16.6	14.6	12.4
60.0			17.2	18.8	18.6	18.0	16.8	15.4	13.8	12.0	10.0
65.0			14.2	16.0	16.0	15.4	14.4	13.0	11.6	9.8	8.0
70.0				13.4	13.6	13.2	12.2	11.0	9.8	8.0	6.2
75.0				11.4	11.8	11.4	10.4	9.2	8.0	6.4	4.6
80.0					10.0	9.8	8.8	7.8	6.6	5.0	3.4
85.0					8.4	8.4	7.4	6.4	5.4	3.8	2.2
90.0					7.0	7.2	6.4	5.2	4.2	2.8	
95.0					5.8	6.0	5.2	4.2	3.2		
100.0						4.8	4.2	3.2	2.2		
105.0						3.8	3.4	2.4			
110.0						3.0	2.6				

THIS CHART IS ONLY A GUIDE AND SHOULD NOT BE USED TO OPERATE THE CRANE.

The individual crane's load chart, operating instructions and other instructional plates must be read and understood prior to operating the crane

Working range

64 m (210 ft) main boom, 11 m - 18 m (36 ft - 59 ft) swingaway and 2 X 8 m (26 ft) inserts

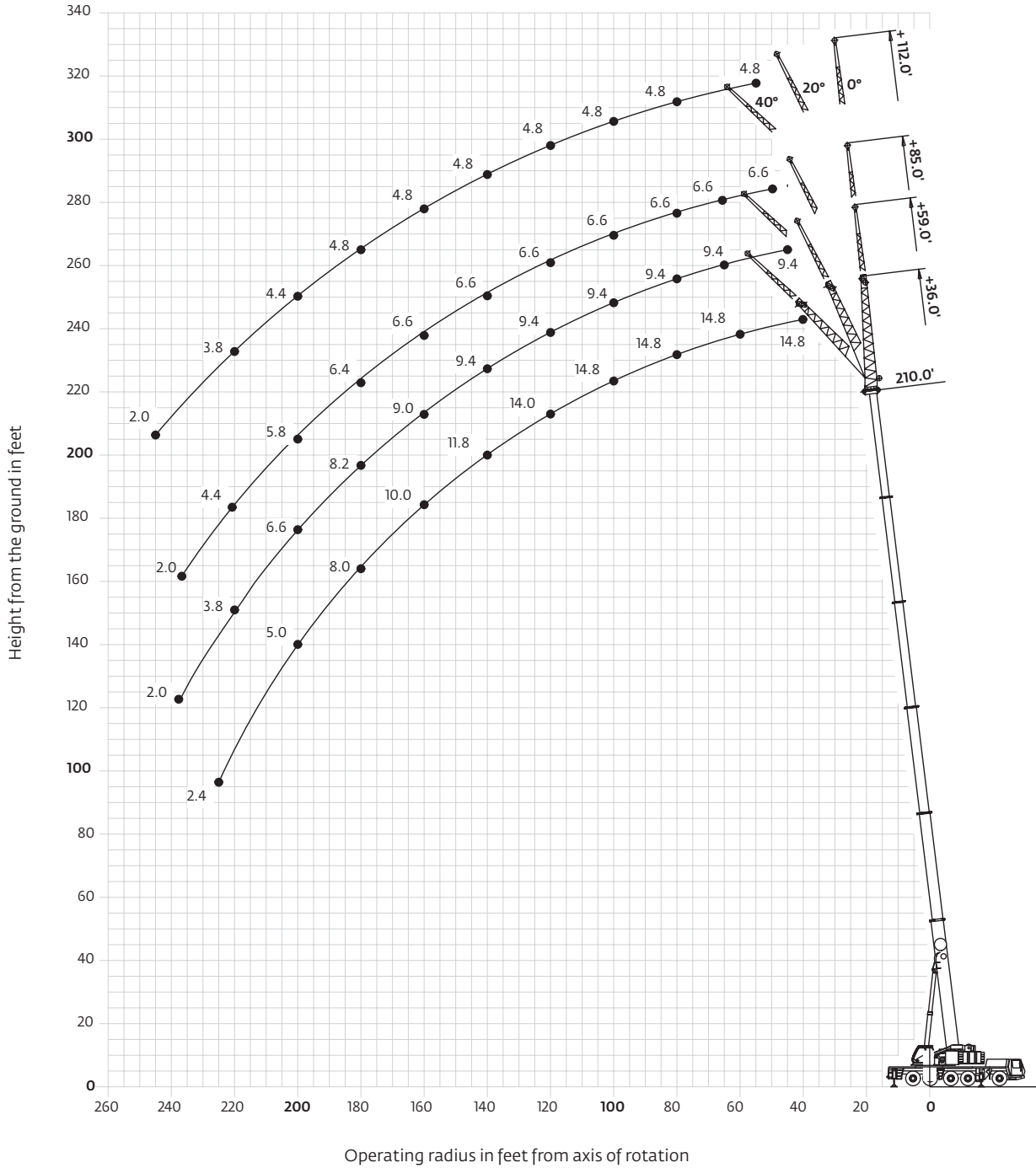

Hook heights shown in the working range diagram do not consider loaded boom deflection.

THIS CHART IS ONLY A GUIDE AND SHOULD NOT BE USED TO OPERATE THE CRANE.

Load charts

Hydraulic offsettable swingaway

Intermediate angle



64 m
(210 ft)



11-18-26-34 m
(36-59-85-112 ft)



53 100 kg
(117,000 lb)



28.1 ft x 25.6 ft spread
(100%)



360°



Pounds x 1000

Feet	210' + 36'			210' + 59'			210' + 85'			210' + 112'		
	0°	0° - 20°	20° - 40°	0°	0° - 20°	20° - 40°	0°	0° - 20°	20° - 40°	0°	0° - 20°	20° - 40°
40.0	14.8			9.4								
45.0	14.8			9.4								
50.0	14.8	14.8		9.4			6.6					
55.0	14.8	14.8	14.8	9.4	9.4		6.6			4.8		
60.0	14.8	14.8	14.8	9.4	9.4		6.6			4.8		
65.0	14.8	14.8	14.8	9.4	9.4		6.6			4.8		
70.0	14.8	14.8	14.8	9.4	9.4		6.6	6.6		4.8		
75.0	14.8	14.8	14.8	9.4	9.4	9.4	6.6	6.6		4.8	4.8	
80.0	14.8	14.8	14.8	9.4	9.4	9.4	6.6	6.6	6.2	4.8	4.8	
85.0	14.8	14.8	14.8	9.4	9.4	9.4	6.6	6.6	6.2	4.8	4.8	
90.0	14.8	14.8	14.8	9.4	9.4	9.4	6.6	6.6	6.2	4.8	4.8	3.6
95.0	14.8	14.8	14.8	9.4	9.4	9.4	6.6	6.6	6.2	4.8	4.8	3.6
100.0	14.8	14.8	14.8	9.4	9.4	9.2	6.6	6.6	6.2	4.8	4.8	3.6
105.0	14.8	14.8	14.8	9.4	9.4	9.2	6.6	6.6	6.2	4.8	4.8	3.6
110.0	14.8	14.4	14.2	9.4	9.4	9.2	6.6	6.6	6.2	4.8	4.8	3.4
115.0	14.6	14.0	13.8	9.4	9.4	9.2	6.6	6.6	6.2	4.8	4.8	3.4
120.0	14.0	13.6	13.4	9.4	9.4	9.2	6.6	6.6	6.2	4.8	4.8	3.4
125.0	13.2	13.2	13.0	9.4	9.4	9.0	6.6	6.6	6.2	4.8	4.8	3.4
130.0	12.6	12.6	12.6	9.4	9.4	9.0	6.6	6.6	6.2	4.8	4.8	3.4
135.0	12.0	12.2	12.2	9.4	9.4	9.0	6.6	6.6	6.2	4.8	4.8	3.4
140.0	11.6	11.8	11.8	9.4	9.2	8.8	6.6	6.6	6.2	4.8	4.8	3.4
145.0	11.0	11.2	11.4	9.4	9.2	8.8	6.6	6.6	6.2	4.8	4.8	3.4
150.0	10.6	10.8	11.0	9.4	9.2	8.8	6.6	6.6	6.2	4.8	4.8	3.4
155.0	10.0	10.2	10.6	9.4	9.0	8.8	6.6	6.6	6.2	4.8	4.8	3.4
160.0	9.6	9.8	10.0	9.0	8.8	8.8	6.6	6.6	6.2	4.8	4.8	3.4
165.0	9.2	9.4	9.6	8.8	8.6	8.6	6.6	6.6	6.2	4.8	4.8	3.4
170.0	8.8	9.0	9.2	8.4	8.4	8.4	6.6	6.6	6.2	4.8	4.8	3.4
175.0	8.2	8.4	8.8	8.0	8.2	8.4	6.6	6.6	6.2	4.8	4.8	3.4
180.0	7.6	7.6	8.0	7.6	8.0	8.2	6.4	6.4	6.2	4.8	4.8	3.4
185.0	6.8	6.8		7.4	7.6	8.0	6.2	6.2	6.2	4.8	4.8	3.4
190.0	6.2	6.2		7.0	7.2	7.6	6.0	6.0	6.2	4.8	4.8	3.4
195.0	5.6	5.6		6.4	6.4	7.4	5.8	5.8	6.0	4.6	4.6	3.4
200.0	5.0	5.0		5.8	5.8	6.6	5.6	5.8	5.8	4.4	4.4	3.4
205.0	4.4	4.4		5.2	5.2		5.4	5.4	5.8	4.2	4.4	3.4
210.0	3.8	3.8		4.8	4.8		4.8	4.8	5.6	4.0	4.2	3.4
215.0	3.4	3.4		4.2	4.2		4.2	4.2	5.0	4.0	4.0	3.4
220.0	2.8	2.8		3.8	3.8		3.8	3.8	4.4	3.8	3.8	3.4
225.0	2.4			3.2	3.2		3.4	3.4		3.2	3.2	3.4
230.0				2.8	2.8		2.8	2.8		2.8	2.8	3.4
235.0				2.4	2.4		2.4	2.4		2.4	2.4	3.0
240.0				2.0	2.0		2.0	2.0		2.0	2.0	2.6

THIS CHART IS ONLY A GUIDE AND SHOULD NOT BE USED TO OPERATE THE CRANE.

The individual crane's load chart, operating instructions and other instructional plates must be read and understood prior to operating the crane.

Load charts

Hydraulic offsettable swingaway

Loads for luffing



64 m
(210 ft)



11-18-26-34 m
(36-59-85-112 ft)



53 100 kg
(117,000 lb)



28.1 ft x 25.6 ft spread
(100%)



360°



Pounds x 1000

Feet	210' + 36'		210' + 59'		210' + 85'		210' + 112'	
	0° - 20°	20° - 40°	0° - 20°	20° - 40°	0° - 20°	20° - 40°	0° - 20°	20° - 40°
50.0	14.8							
55.0	14.8	14.6	9.4					
60.0	14.8	14.6	9.4					
65.0	14.8	14.6	9.4					
70.0	14.8	14.6	9.4					
75.0	14.8	14.6	9.4		6.6			
80.0	14.8	14.6	9.2	9.0	6.6		4.8	
85.0	14.8	14.6	9.2	9.0	6.6	5.8	4.8	
90.0	14.8	14.6	9.2	9.0	6.6	5.8	4.8	3.4
95.0	14.8	14.6	9.2	8.8	6.6	5.8	4.8	3.4
100.0	14.6	14.4	9.2	8.8	6.6	5.8	4.8	3.4
105.0	14.2	14.0	9.2	8.8	6.6	5.8	4.8	3.4
110.0	13.8	13.6	9.2	8.8	6.6	5.8	4.8	3.4
115.0	13.2	13.2	9.0	8.8	6.6	5.8	4.8	3.4
120.0	12.8	12.8	9.0	8.6	6.6	5.8	4.8	3.4
125.0	12.4	12.4	9.0	8.6	6.6	5.8	4.8	3.4
130.0	12.0	12.0	9.0	8.6	6.6	5.8	4.8	3.4
135.0	11.6	11.6	8.8	8.6	6.6	5.8	4.8	3.4
140.0	11.2	11.2	8.8	8.4	6.6	5.8	4.8	3.4
145.0	10.6	11.0	8.8	8.4	6.6	5.8	4.8	3.4
150.0	10.2	10.6	8.6	8.4	6.6	5.8	4.8	3.4
155.0	9.8	10.0	8.6	8.2	6.6	5.8	4.8	3.4
160.0	9.4	9.6	8.4	8.2	6.6	5.8	4.8	3.4
165.0	9.0	9.2	8.2	8.2	6.6	5.8	4.8	3.4
170.0	8.4	8.8	8.0	8.0	6.6	5.8	4.8	3.4
175.0	7.6	8.2	7.8	8.0	6.4	5.8	4.8	3.4
180.0	7.0	7.4	7.6	7.8	6.2	5.8	4.8	3.4
185.0	6.4		7.2	7.6	6.0	5.8	4.8	3.4
190.0	5.8		6.6	7.2	5.8	5.8	4.6	3.4
195.0	5.2		6.0	6.8	5.6	5.8	4.4	3.4
200.0	4.6		5.4	6.2	5.4	5.6	4.2	3.4
205.0	4.2		5.0		5.0	5.4	4.2	3.4
210.0	3.6		4.4		4.6	5.2	4.0	3.4
215.0	3.2		4.0		4.0	4.8	3.8	3.4
220.0	2.8		3.6		3.6	4.2	3.6	3.4
225.0			3.2		3.2		3.2	3.4
230.0			2.8		2.8		2.8	3.4
235.0			2.4		2.4		2.4	3.0
240.0			2.0		2.0		2.0	2.6



THIS CHART IS ONLY A GUIDE AND SHOULD NOT BE USED TO OPERATE THE CRANE.

Load charts

Hydraulic offsettable swingaway

Intermediate angle



 **64 m**
(210 ft)
  **11-18-26-34 m**
(36-59-85-112 ft)
  **23 100 kg**
(50,900 lb)
  **28.1 ft x 25.6 ft spread**
(100%)
  **360°**

 **Pounds x 1000**

Feet	210' + 36'		210' + 59'		210' + 85'		210' + 112'	
	0°	20° - 40°	0°	20° - 40°	0°	20° - 40°	0°	20° - 40°
40.0	14.8		9.4					
45.0	14.8		9.4					
50.0	14.8	14.8	9.4		6.6			
55.0	14.8	14.8	9.4	9.4	6.6		4.8	
60.0	14.8	14.8	9.4	9.4	6.6		4.8	
65.0	14.8	14.8	9.4	9.4	6.6		4.8	
70.0	14.8	14.8	9.4	9.4	6.6	6.6	4.8	
75.0	14.8	14.8	9.4	9.4	6.6	6.6	4.8	4.8
80.0	14.8	14.8	9.4	9.4	6.6	6.6	4.8	4.8
85.0	14.8	14.8	9.4	9.4	6.6	6.6	4.8	4.8
90.0	13.4	13.4	9.4	9.4	6.6	6.6	4.8	3.6
95.0	11.8	11.8	9.4	9.4	6.6	6.6	4.8	3.6
100.0	10.4	10.4	9.4	9.4	6.6	6.6	4.8	3.6
105.0	9.2	9.2	9.4	9.4	6.6	6.6	4.8	3.6
110.0	8.0	8.0	8.6	8.6	6.6	6.6	4.8	3.4
115.0	7.0	7.0	7.6	7.6	6.6	6.6	4.8	3.4
120.0	6.0	6.0	6.6	6.6	6.4	6.4	4.8	3.4
125.0	5.2	5.2	5.8	5.8	5.6	5.6	4.8	3.4
130.0	4.4	4.4	5.0	5.0	4.8	4.8	4.6	3.4
135.0	3.6	3.6	4.4	4.2	4.0	4.0	3.8	3.4
140.0	2.8	2.8	3.6	3.6	3.4	3.4	3.2	3.4
145.0	2.2	2.2	3.0	3.0	2.8	2.8	2.4	3.4
150.0			2.4	2.4	2.2	2.2	2.0	3.4
155.0								2.6
160.0								2.0

Loads for luffing

 **64 m**
(210 ft)
  **11-18-26-34 m**
(36-59-85-112 ft)
  **23 100 kg**
(50,900 lb)
  **28.1 ft x 25.6 ft spread**
(100%)
  **360°**

 **Pounds x 1000**

Feet	210' + 36'		210' + 59'		210' + 85'		210' + 112'	
	0° - 20°	20° - 40°	0° - 20°	20° - 40°	0° - 20°	20° - 40°	0° - 20°	20° - 40°
50.0	14.8		9.4					
55.0	14.8	14.6	9.4					
60.0	14.8	14.6	9.4					
65.0	14.8	14.6	9.4					
70.0	14.8	14.6	9.4		6.6			
75.0	14.8	14.6	9.4	9.0	6.6		4.8	
80.0	14.8	14.6	9.2	9.0	6.6	5.8	4.8	
85.0	14.8	14.6	9.2	9.0	6.6	5.8	4.8	
90.0	13.4	14.6	9.2	9.0	6.6	5.8	4.8	3.4
95.0	11.8	13.2	9.2	8.8	6.6	5.8	4.8	3.4
100.0	10.4	11.8	9.2	8.8	6.6	5.8	4.8	3.4
105.0	9.2	10.4	9.2	8.8	6.6	5.8	4.8	3.4
110.0	8.0	9.2	8.6	8.8	6.6	5.8	4.8	3.4
115.0	7.0	8.0	7.6	8.8	6.6	5.8	4.8	3.4
120.0	6.0	7.0	6.6	8.4	6.4	5.8	4.8	3.4
125.0	5.2	6.0	5.8	7.6	5.6	5.8	4.8	3.4
130.0	4.4	5.2	5.0	6.6	4.8	5.8	4.6	3.4
135.0	3.6	4.4	4.2	5.8	4.0	5.6	3.8	3.4
140.0	2.8	3.6	3.6	5.0	3.4	4.8	3.2	3.4
145.0	2.2	3.0	3.0	4.2	2.8	4.2	2.4	3.4
150.0		2.2	2.4	3.6	2.2	3.4	2.0	3.4
155.0				3.0		2.8		2.6
160.0				2.4		2.2		2.0

THIS CHART IS ONLY A GUIDE AND SHOULD NOT BE USED TO OPERATE THE CRANE.

The individual crane's load chart, operating instructions and other instructional plates must be read and understood prior to operating the crane.

Load charts

Manual offsettable swingaway



64 m
(210 ft)



11-18-26-34 m
(36-59-85-112 ft)



53 100 kg
(117,000 lb)



28.1 ft x 25.6 ft spread
(100%)



360°



Pounds x 1000

Feet	210' + 36'			210' + 59'			210' + 85'			210' + 112'		
	0°	20°	40°	0°	20°	40°	0°	20°	40°	0°	20°	40°
40.0	14.8											
45.0	14.8			9.4								
50.0	14.8	14.8		9.4			6.6					
55.0	14.8	14.8	14.8	9.4			6.6			4.8		
60.0	14.8	14.8	14.8	9.4	9.4		6.6			4.8		
65.0	14.8	14.8	14.8	9.4	9.4		6.6			4.8		
70.0	14.8	14.8	14.8	9.4	9.4		6.6	6.6		4.8		
75.0	14.8	14.8	14.8	9.4	9.4	9.4	6.6	6.6		4.8	4.8	
80.0	14.8	14.8	14.8	9.4	9.4	9.4	6.6	6.6	6.2	4.8	4.8	
85.0	14.8	14.8	14.8	9.4	9.4	9.4	6.6	6.6	6.2	4.8	4.8	
90.0	14.8	14.8	14.8	9.4	9.4	9.4	6.6	6.6	6.2	4.8	4.8	3.6
95.0	14.8	14.8	14.8	9.4	9.4	9.4	6.6	6.6	6.2	4.8	4.8	3.6
100.0	14.8	14.8	14.8	9.4	9.4	9.2	6.6	6.6	6.2	4.8	4.8	3.6
105.0	14.8	14.8	14.8	9.4	9.4	9.2	6.6	6.6	6.2	4.8	4.8	3.6
110.0	14.8	14.4	14.2	9.4	9.4	9.2	6.6	6.6	6.2	4.8	4.8	3.4
115.0	14.6	14.0	13.8	9.4	9.4	9.2	6.6	6.6	6.2	4.8	4.8	3.4
120.0	14.0	13.6	13.4	9.4	9.4	9.2	6.6	6.6	6.2	4.8	4.8	3.4
125.0	13.2	13.2	13.0	9.4	9.4	9.0	6.6	6.6	6.2	4.8	4.8	3.4
130.0	12.6	12.6	12.6	9.4	9.4	9.0	6.6	6.6	6.2	4.8	4.8	3.4
135.0	12.0	12.2	12.2	9.4	9.4	9.0	6.6	6.6	6.2	4.8	4.8	3.4
140.0	11.6	11.8	11.8	9.4	9.2	8.8	6.6	6.6	6.2	4.8	4.8	3.4
145.0	11.0	11.2	11.4	9.4	9.2	8.8	6.6	6.6	6.2	4.8	4.8	3.4
150.0	10.6	10.8	11.0	9.4	9.2	8.8	6.6	6.6	6.2	4.8	4.8	3.4
155.0	10.0	10.2	10.6	9.4	9.0	8.8	6.6	6.6	6.2	4.8	4.8	3.4
160.0	9.6	9.8	10.0	9.0	8.8	8.8	6.6	6.6	6.2	4.8	4.8	3.4
165.0	9.2	9.4	9.6	8.8	8.6	8.6	6.6	6.6	6.2	4.8	4.8	3.4
170.0	8.8	9.0	9.2	8.4	8.4	8.4	6.6	6.6	6.2	4.8	4.8	3.4
175.0	8.2	8.6	8.8	8.0	8.2	8.4	6.6	6.6	6.2	4.8	4.8	3.4
180.0	7.6	8.0	8.2	7.6	8.0	8.2	6.4	6.4	6.2	4.8	4.8	3.4
185.0	6.8	7.2		7.4	7.6	8.0	6.2	6.2	6.2	4.8	4.8	3.4
190.0	6.2	6.6		7.0	7.4	7.6	6.0	6.0	6.2	4.8	4.8	3.4
195.0	5.6	5.8		6.4	7.0	7.4	5.8	5.8	6.0	4.6	4.6	3.4
200.0	5.0	5.2		5.8	6.6	7.0	5.6	5.8	5.8	4.4	4.4	3.4
205.0	4.4	4.6		5.2	6.0		5.4	5.6	5.8	4.2	4.4	3.4
210.0	3.8	4.0		4.8	5.4		4.8	5.4	5.6	4.0	4.2	3.4
215.0	3.4	3.6		4.2	4.8		4.2	5.0	5.4	4.0	4.0	3.4
220.0	2.8	3.0		3.8	4.2		3.8	4.4	4.8	3.8	3.8	3.4
225.0	2.4			3.2	3.8		3.4	3.4		3.2	3.8	3.4
230.0				2.8	3.2		2.8	3.0		2.8	3.6	3.4
235.0				2.4	2.8		2.4	2.6		2.4	3.0	3.4
240.0				2.0	2.4		2.0	2.2		2.0	2.6	2.8
245.0												2.2



64 m
(210 ft)



11-18-26-34 m
(36-59-85-112 ft)



23 100 kg
(50,900 lb)



28.1 ft x 25.6 ft spread
(100%)



360°



Pounds x 1000

Feet	210' + 36'			210' + 59'			210' + 85'			210' + 112'		
	0°	20°	40°	0°	20°	40°	0°	20°	40°	0°	20°	40°
40.0	14.8											
45.0	14.8			9.4								
50.0	14.8	14.8		9.4			6.6					
55.0	14.8	14.8	14.8	9.4	9.4		6.6			4.8		
60.0	14.8	14.8	14.8	9.4	9.4		6.6			4.8		
65.0	14.8	14.8	14.8	9.4	9.4		6.6			4.8		
70.0	14.8	14.8	14.8	9.4	9.4		6.6	6.6		4.8		
75.0	14.8	14.8	14.8	9.4	9.4	9.4	6.6	6.6		4.8	4.8	
80.0	14.8	14.8	14.8	9.4	9.4	9.4	6.6	6.6	6.2	4.8	4.8	
85.0	14.8	14.8	14.8	9.4	9.4	9.4	6.6	6.6	6.2	4.8	4.8	
90.0	13.4	14.8	14.8	9.4	9.4	9.4	6.6	6.6	6.2	4.8	4.8	3.6
95.0	11.8	13.2	14.4	9.4	9.4	9.4	6.6	6.6	6.2	4.8	4.8	3.6
100.0	10.4	11.8	12.8	9.4	9.4	9.2	6.6	6.6	6.2	4.8	4.8	3.6
105.0	9.2	10.4	11.4	9.4	9.4	9.2	6.6	6.6	6.2	4.8	4.8	3.6
110.0	8.0	9.2	10.0	8.6	9.4	9.2	6.6	6.6	6.2	4.8	4.8	3.4
115.0	7.0	8.0	8.8	7.6	9.4	9.2	6.6	6.6	6.2	4.8	4.8	3.4
120.0	6.0	7.0	7.8	6.6	8.4	9.2	6.4	6.6	6.2	4.8	4.8	3.4
125.0	5.2	6.0	6.8	5.8	7.6	8.8	5.6	6.6	6.2	4.8	4.8	3.4
130.0	4.4	5.2	5.8	5.0	6.6	7.8	4.8	6.4	6.2	4.6	4.8	3.4
135.0	3.6	4.4	5.0	4.2	5.8	7.0	4.0	5.6	6.2	3.8	4.8	3.4
140.0	2.8	3.6	4.2	3.6	5.0	6.0	3.4	4.8	6.0	3.2	4.6	3.4
145.0	2.2	3.0	3.4	3.0	4.2	5.2	2.8	4.2	5.2	2.4	4.0	3.4
150.0		2.2	2.6	2.4	3.6	4.6	2.2	3.4	4.6	2.0	3.4	3.4
155.0			2.0		3.0	3.8		2.8	3.8		2.6	3.4
160.0					2.4	3.2		2.2	3.2		2.0	3.0
165.0						2.6			2.6			2.4
170.0						2.0			2.0			

THIS CHART IS ONLY A GUIDE AND SHOULD NOT BE USED TO OPERATE THE CRANE.

The individual crane's load chart, operating instructions and other instructional plates must be read and understood prior to operating the crane.

Working range

13,7 m - 64 m (45 ft - 210 ft) main boom with 3,6 m (11.8 ft) heavy duty jib

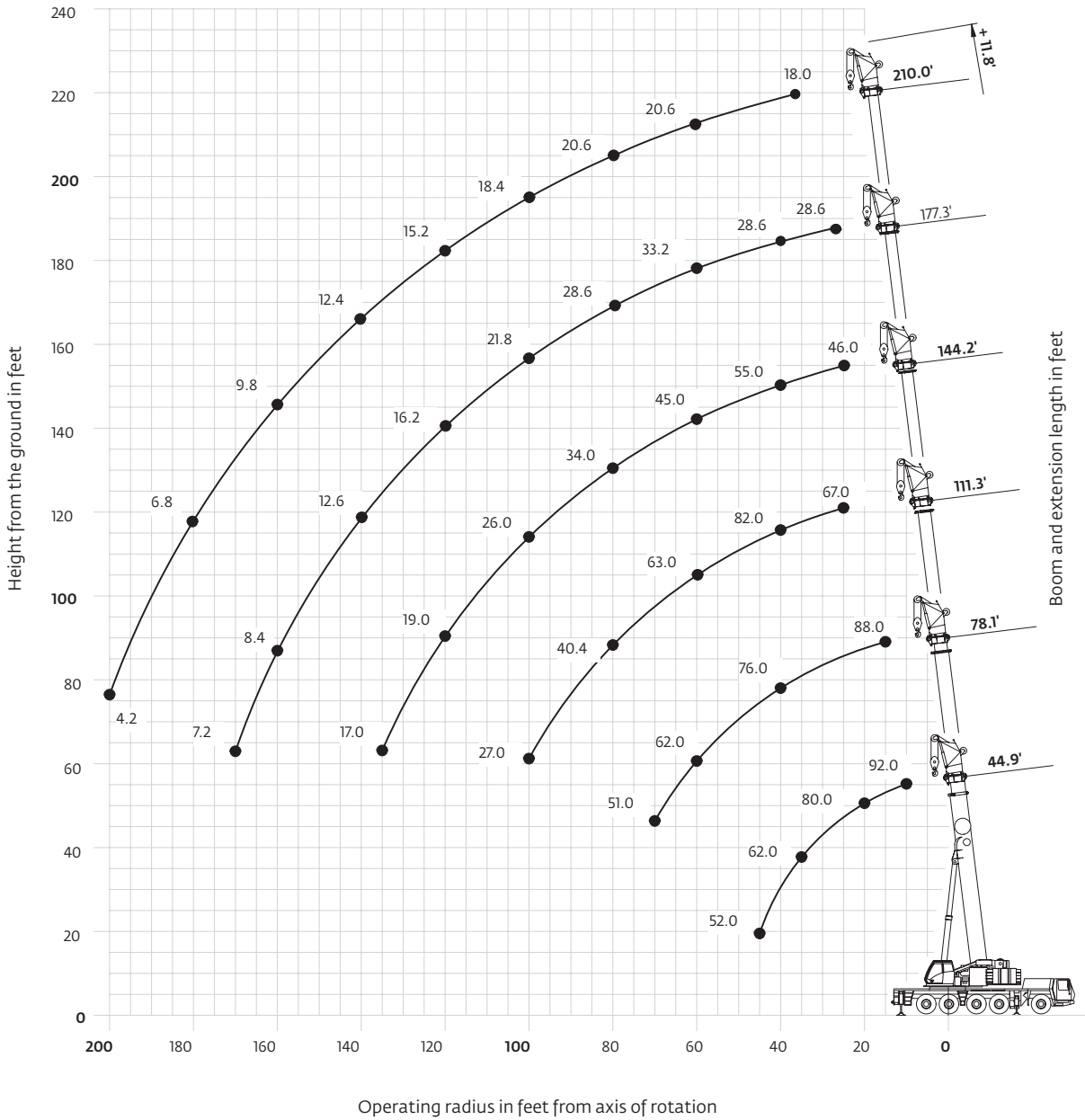

Hook heights shown in the working range diagram do not consider loaded boom deflection.

THIS CHART IS ONLY A GUIDE AND SHOULD NOT BE USED TO OPERATE THE CRANE.

The individual crane's load chart, operating instructions and other instructional plates must be read and understood prior to operating the crane.

Load charts

Integrated heavy duty jib

Intermediate angle

13,7 m - 64 m
(44.9 ft - 210 ft)

3,6 m
(11.8 ft)

53 100 kg
(117,000 lb)

28.1 ft x 25.6 ft spread
(100%)

360°

Feet	44.9' + 11.8'			78.1' + 11.8'			111.3' + 11.8'			144.2' + 11.8'			177.3' + 11.8'			210.0' + 11.8'		
	0°	20°	40°	0°	20°	40°	0°	20°	40°	0°	20°	40°	0°	20°	40°	0°	20°	40°
10.0	92.0	88.0	88.0															
15.0	85.0	85.0	85.0			88.0												
20.0	80.0	79.0	80.0	91.0	87.0	87.0			67.0									
25.0	72.0	73.0	75.0	87.0	85.0	85.0			67.0			46.0						
30.0	64.0	67.0	71.0	83.0	83.0	82.0	86.0	70.0	67.0			46.0				28.6		
35.0	59.0	62.0		79.0	78.0	79.0	84.0	70.0	67.0			46.0				28.6		
40.0	55.0	61.0		74.0	74.0	76.0	82.0	70.0	67.0	55.0	46.0	46.0				28.6		18.0
45.0	52.0			69.0	70.0	73.0	79.0	70.0	67.0	54.0	46.0	46.0	33.2	28.6	28.6			18.0
50.0				64.0	67.0	71.0	73.0	70.0	67.0	51.0	46.0	46.0	33.2	28.6	28.6			18.0
55.0				61.0	64.0	69.0	68.0	68.0	67.0	48.0	46.0	46.0	33.2	28.6	28.6	20.6	18.0	18.0
60.0				57.0	62.0		62.0	63.0	63.0	45.0	45.0	45.0	33.2	28.6	28.6	20.6	18.0	18.0
65.0				55.0	57.0		56.0	56.0	56.0	41.2	41.4	42.2	31.8	28.6	28.6	20.6	18.0	18.0
70.0				51.0	51.0		50.0	50.0	51.0	38.6	38.6	39.2	30.6	28.6	28.6	20.6	18.0	18.0
75.0							45.0	45.0	46.0	35.8	36.0	36.4	29.2	28.6	28.6	20.6	18.0	18.0
80.0							40.2	40.4	40.4	33.4	33.6	34.0	28.0	27.8	28.6	20.6	18.0	18.0
85.0							36.2	36.4	36.4	31.4	31.4	31.8	26.6	26.6	27.2	20.6	18.0	18.0
90.0							32.6	32.8		29.4	29.4	29.8	25.0	25.0	25.4	20.6	18.0	18.0
95.0							29.6	29.8		27.4	27.6	27.8	23.4	23.4	23.0	19.4	18.0	18.0
100.0							26.8	27.0		25.8	26.0	26.0	21.8	21.8	20.8	18.4	18.0	18.0
105.0										24.4	24.4	24.0	20.0	20.0	19.6	17.4	17.4	17.8
110.0										22.2	22.2	22.0	18.2	18.4	18.4	16.6	16.6	16.8
115.0										20.2	20.2		17.0	17.0	17.2	15.6	15.8	16.0
120.0										18.8	19.0		16.0	16.0	16.2	15.0	15.0	15.2
125.0										18.0	18.4		15.0	15.0	15.2	14.2	14.2	14.4
130.0										17.4	17.8		14.2	14.2	14.4	13.6	13.6	13.8
135.0										17.0	13.8		13.4	13.4		12.8	13.0	13.0
140.0													12.6	12.6		12.2	12.2	12.4
145.0													11.4	11.4		11.6	11.6	11.8
150.0													10.4	10.4		11.0	11.0	11.0
155.0													9.4	9.4		10.4	10.4	10.4
160.0													8.4	8.4		9.8	9.8	
165.0													7.6			9.2	9.2	
170.0													7.2			8.4	8.4	
175.0																7.6	7.6	
180.0																6.8	6.8	
185.0																6.2	6.2	
190.0																5.6	5.6	
195.0																4.8	4.8	
200.0																4.2		

THIS CHART IS ONLY A GUIDE AND SHOULD NOT BE USED TO OPERATE THE CRANE.

Load charts

Integrated heavy duty jib

Loads for luffing



13,7 m - 64 m
(44.9 ft - 210 ft)



3,6 m
(11.8 ft)



53 100 kg
(117,000 lb)



28.1 ft x 25.6 ft spread
(100%)



360°



Pounds x 1000

Feet	44.9' + 11.8'		78.1' + 11.8'		111.3' + 11.8'		144.2' + 11.8'		177.3' + 11.8'		210.0' + 11.8'	
	0°-20°	20°-40°	0°-20°	20°-40°	0°-20°	20°-40°	0°-20°	20°-40°	0°-20°	20°-40°	0°-20°	20°-40°
10.0	65.0	65.0										
15.0	63.0	63.0		66.0								
20.0	59.0	61.0	64.0	64.0		64.0						
25.0	56.0	61.0	63.0	63.0		64.0		43.6				
30.0	54.0	61.0	61.0	62.0	64.0	64.0		43.6		27.4		
35.0	53.0		59.0	61.0	63.0	63.0		43.6		27.4		
40.0	52.0		57.0	61.0	62.0	62.0	44.0	43.6		27.4		17.4
45.0			56.0	60.0	61.0	62.0	44.0	43.6	27.4	27.4		17.4
50.0			54.0	60.0	59.0	61.0	44.0	43.6	27.4	27.4		17.4
55.0			53.0	61.0	58.0	61.0	44.0	43.6	27.4	27.4	18.0	17.4
60.0			52.0		56.0	60.0	42.8	43.2	27.4	27.4	18.0	17.4
65.0			52.0		53.0	53.0	39.4	40.2	27.4	27.4	18.0	17.4
70.0			47.0		47.0	47.0	36.8	37.4	27.4	27.4	18.0	17.4
75.0					41.6	41.6	34.2	34.8	27.4	27.4	18.0	17.4
80.0					37.2	37.2	32.0	32.2	26.6	27.2	18.0	17.4
85.0					33.4	33.4	30.0	30.2	25.2	26.0	18.0	17.4
90.0					30.2		28.0	28.2	23.8	24.2	18.0	17.4
95.0					27.4		26.2	26.6	22.4	22.0	18.0	17.4
100.0					24.8		24.8	24.8	20.8	19.8	17.4	17.4
105.0							22.4	22.4	19.2	18.6	16.6	17.0
110.0							20.4	20.4	17.4	17.4	15.8	16.0
115.0							18.8		16.2	16.4	15.0	15.2
120.0							18.2		15.4	15.4	14.4	14.6
125.0							17.4		14.4	14.4	13.6	13.8
130.0							16.6		13.6	13.6	13.0	13.2
135.0									12.8		12.4	12.4
140.0									11.6		11.6	11.8
145.0									10.6		11.0	11.2
150.0									9.6		10.4	10.6
155.0									8.6		9.8	10.0
160.0									7.8		9.4	
165.0											8.6	
170.0											7.8	
175.0											7.2	
180.0											6.4	
185.0											5.8	
190.0											5.2	
195.0											4.6	

Load charts

Integrated heavy duty jib

Intermediate angle

 13,7 m - 64 m (44.9 ft - 210 ft)
  3,6 m (11.8 ft)
  23 100 kg (50,900 lb)
  28.1 ft x 25.6 ft spread (100%)
  360°

Feet	Pounds x 1000																	
	44.9' + 11.8'			78.1' + 11.8'			111.3' + 11.8'			144.2' + 11.8'			177.3' + 11.8'			210.0' + 11.8'		
	0°	20°	40°	0°	20°	40°	0°	20°	40°	0°	20°	40°	0°	20°	40°	0°	20°	40°
10.0	92.0	88.0	88.0															
15.0	85.0	85.0	85.0															
20.0	80.0	79.0	80.0	91.0	87.0	87.0			67.0									
25.0	72.0	73.0	75.0	87.0	85.0	85.0			67.0			46.0						
30.0	64.0	67.0	71.0	83.0	83.0	82.0	86.0	70.0	67.0			46.0				28.6		
35.0	59.0	62.0		79.0	78.0	79.0	72.0	70.0	67.0			46.0				28.6		
40.0	55.0	61.0		66.0	66.0	67.0	60.0	60.0	60.0	55.0	46.0	46.0				28.6		18.0
45.0	52.0			56.0	56.0	56.0	50.0	50.0	51.0	46.0	46.0	46.0	33.2	28.6	28.6			18.0
50.0				47.0	47.0	48.0	42.4	42.6	43.2	40.8	40.4	41.2	33.2	28.6	28.6			18.0
55.0				40.0	40.0	40.6	36.4	36.6	37.0	37.6	37.6	38.2	31.8	28.6	28.6	20.6	18.0	18.0
60.0				36.6	37.2		31.6	31.8	32.0	33.0	33.0	33.4	28.4	27.6	28.0	20.6	18.0	18.0
65.0				34.0	34.0		27.4	27.6	27.8	29.0	29.0	29.6	27.0	24.0	24.4	20.6	18.0	18.0
70.0				30.0	30.0		24.0	24.0	24.2	25.6	25.6	26.2	25.4	22.6	22.6	20.6	18.0	18.0
75.0							21.0	21.0	21.2	22.8	22.8	23.2	22.8	22.6	22.6	19.2	18.0	18.0
80.0							18.2	18.2	18.4	20.4	20.4	20.6	20.4	20.4	20.6	17.0	17.0	17.2
85.0							15.6	15.8	15.8	18.2	18.2	18.4	18.4	18.4	18.6	15.0	15.0	15.2
90.0							14.2	14.4		16.2	16.2	16.4	16.6	16.6	16.6	13.2	13.2	13.4
95.0							13.2	13.6		14.4	14.4	14.6	14.8	14.8	15.0	11.8	11.8	11.8
100.0							12.6	12.8		12.8	12.8	13.2	13.4	13.4	13.4	10.2	10.2	10.4
105.0										11.4	11.4	8.2	12.0	12.0	12.0	9.0	9.0	9.2
110.0										9.8	9.8	6.8	10.8	10.8	10.8	7.8	7.8	8.0
115.0										8.6	8.6		9.6	9.6	9.6	6.8	6.8	6.8
120.0										7.4	7.4		8.6	8.6	8.6	5.8	5.8	5.8
125.0										6.4	6.4		7.6	7.6	7.6	4.8	4.8	4.8
130.0										5.4	5.4		6.6	6.6	6.6	4.0	4.0	4.0
135.0										4.6			5.8	5.8		3.2	3.2	3.2
140.0													4.8	4.8		2.4	2.4	2.6
145.0													4.2	4.2				
150.0													3.4	3.4				
155.0													2.8	2.8				
160.0													2.2	2.2				

Loads for luffing

 13,7 m - 64 m (44.9 ft - 210 ft)
  3,6 m (11.8 ft)
  23 100 kg (50,900 lb)
  28.1 ft x 25.6 ft spread (100%)
  360°

Feet	Pounds x 1000											
	44.9' + 11.8'		78.1' + 11.8'		111.3' + 11.8'		144.2' + 11.8'		177.3' + 11.8'		210.0' + 11.8'	
	0°-20°	20°-40°	0°-20°	20°-40°	0°-20°	20°-40°	0°-20°	20°-40°	0°-20°	20°-40°	0°-20°	20°-40°
10.0	65.0	65.0										
15.0	63.0	63.0		66.0								
20.0	59.0	61.0	64.0	64.0		64.0						
25.0	56.0	61.0	63.0	63.0		64.0		43.6				
30.0	54.0	61.0	61.0	62.0	64.0	64.0		43.6		27.4		
35.0	53.0		59.0	61.0	63.0	63.0		43.6		27.4		
40.0	52.0		57.0	61.0	60.0	60.0	44.0	43.6		27.4		17.4
45.0			55.0	55.0	50.0	51.0	44.0	43.6	27.4	27.4		17.4
50.0			45.0	45.0	42.6	43.2	39.4	40.0	27.4	27.4		17.4
55.0			38.2	38.6	36.6	37.0	36.2	36.8	27.4	27.4	18.0	17.4
60.0			35.6		31.6	31.8	33.0	33.4	27.4	27.4	18.0	17.4
65.0			31.6		26.8	27.0	29.0	29.6	24.0	24.4	18.0	17.4
70.0			27.6		23.0	23.0	25.6	26.2	21.6	21.6	18.0	17.4
75.0					19.8	19.8	22.6	23.0	21.6	21.6	18.0	17.4
80.0					17.0		19.8	20.2	20.4	20.4	17.0	17.2
85.0					14.6		17.4	17.6	18.4	18.6	15.0	15.2
90.0					13.6		15.4	15.6	16.6	16.6	13.2	13.4
95.0					12.8		13.4	13.6	14.6	14.8	11.8	11.8
100.0					12.2		11.8	12.0	13.0	13.2	10.2	10.4
105.0							10.4	7.6	11.6	11.6	9.0	9.2
110.0							9.0	6.4	10.2	10.2	7.8	8.0
115.0							8.0		9.0	9.0	6.8	6.8
120.0							6.8		8.0	8.0	5.8	5.8
125.0							6.0		7.0	7.0	4.8	4.8
130.0							5.0		6.2	6.2	4.0	4.0
135.0									5.2		3.2	3.2
140.0									4.6		2.4	2.6
145.0									3.8			
150.0									3.2			
155.0									2.6			
160.0									2.0			

THIS CHART IS ONLY A GUIDE AND SHOULD NOT BE USED TO OPERATE THE CRANE.

Symbols glossary



Axles



Counterweight



Grade



Radius



Boom



Drive



Hoist



Rotation



Boom elevation



Electrical system



Hookblock



Speed



Boom extension



Engine



Hydraulic system



Steering



Boom length



Extension



Lights



Suspension



Boom nose



Frame



Oil



Swing



Brakes



Fuel tank capacity



Outrigger controls



Tires



Cab



Gear



Outriggers



Transmission

Notes

Notes

Manitowoc Cranes

Regional headquarters

Americas

Manitowoc, Wisconsin, USA

Tel: +1 920 684 6621

Fax: +1 920 683 6277

Shady Grove, Pennsylvania, USA

Tel: +1 717 597 8121

Fax: +1 717 597 4062

Europe, Middle East, Africa

Dardilly, France

Tel: +33 (0)4 72 18 20 20

Fax: +33 (0)4 72 18 20 00

China

Shanghai, China

Tel: +86 21 6457 0066

Fax: +86 21 6457 4955

Greater Asia-Pacific

Singapore

Tel: +65 6264 1188

Fax: +65 6862 4040

Regional offices

Americas

Brazil

Alphaville

Mexico

Monterrey

Chile

Santiago

Europe, Middle East,

Africa

France

Dardilly

Saint Pierre de Chandieu

Germany

Langenfeld

Italy

Lainate

Netherlands

Breda

Poland

Warsaw

Portugal

Baltar

Russia

Moscow

South Africa

Johannesburg

U.A.E.

Dubai

U.K.

Buckingham

China

Beijing

Chengdu

Guangzhou

Xian

Greater Asia-Pacific

Australia

Brisbane

Sydney

India

Ahmedabad

Bengaluru

Chennai

Gurgaon

Hyderabad

Kolkata

Mumbai

Noida

Pune

Korea

Seoul

Philippines

Makati City

Singapore

Factories

Brazil

Passo Fundo

China

Zhangjiagang

France

Charlieu

Moulines

Germany

Wilhelmshaven

India

Pune

Italy

Niella Tanaro

Portugal

Baltar

Fânzeres

USA

Manitowoc

Port Washington

Shady Grove

This document is non-contractual. Constant improvement and engineering progress make it necessary that we reserve the right to make specification, equipment, and price changes without notice. Illustrations shown may include optional equipment and accessories and may not include all standard equipment.