

Liftcrane Boom Capacities With Luffing Jib Attached

MLC650 SERIES 3

Boom No. B10:680
Luffing Jib No. LJ10:681-682
881,800 lb VPC (Variable Position Counterweight)
360 Degree Rating

 **LIFTING CAPACITIES:** Lifting capacities for various boom lengths, luffing jib lengths, boom-to-luffing jib angles, and boom operating radii are for freely suspended loads and may be based on percent of static tipping or strength of structural components. Capacities must be reduced by applicable deducts.

Weight of all load blocks, hooks, weight ball, slings, hoist lines, etc., beneath boom point sheaves, is considered part of load. Weight of luffing jib and 35,000 lb suspended beneath luffing jib point sheaves have been included in capacity determination. Boom is not to be lowered beyond radii where combined weights are greater than rated capacity. Where no capacity is shown, operation is not intended or approved.

OPERATING CONDITIONS: Machine to operate on a firm, level, and uniformly supporting surface. Supporting surface and bearing turntable are to be level within a tolerance of 1/2 in. in 10 ft. During operation, luffing jib must be maintained at proper boom-to-luffing jib angle shown in table. Refer to Luffing Jib Rigging **No. 81018143**, Wire Rope Specifications chart **No. 9855-A**, Counterweight Arrangements chart **No. 9349-A**, Luffing Jib Raising Procedure chart **No. 9521-A**, and Wind Conditions chart **No. 9523-A**. Crane operator judgment must be used to allow for dynamic load effects of swinging, hoisting or lowering, travel, wind conditions, as well as adverse operating conditions and physical machine depreciation. Refer to the Operator Manual for operating guidelines.

MACHINE TRAVEL: Machine to travel on a firm, level, and uniformly supporting surface. Boom and luffing jib must be within angle range shown in capacity chart. Refer to Maximum Allowable Travel Specifications chart **No. 9522-A**.

 **OPERATING RADIUS:** Operating radius is horizontal distance from axis of rotation to center of vertical hoist line or load block.

 **BOOM ANGLE:** Boom angle in degrees (°) is angle between horizontal and centerline of boom butt and inserts, and is an indication of operating radius. In all cases, operating radius shall govern capacity.

 **BOOM POINT ELEVATION:** Boom point elevation is vertical distance from ground level to centerline of boom point shaft.

MACHINE EQUIPMENT: Machine equipped with 36 ft 6 in. crawlers, 60 in. or 80 in. treads, 36 ft 1 in. live mast, 30 part boom hoist reeving, boom support straps, 20 part luffing jib hoist reeving, luffing jib and backstay support straps, and 881,800 lb VPC.

Consult chart **No. 9393-A** for luffing jib capacities.

Luffing Jib Position During Operation	
Luffing Jib Length Feet	Boom-to-Luffing Jib Angle Degrees
85.3 - 95.1	140
105.0 - 144.4	155
154.2 - 331.4	169

Explanation of Symbols

- 

LJ10 Luffing Jib No. LJ10:681-682
+
B10 Boom No. B10:680
- 

VPC (Variable Position Counterweight)
- 

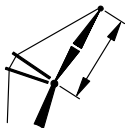
360 Degree Rating
- 

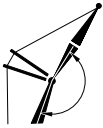
Luffing Jib Length
- 

Boom-to-Luffing Jib Angle
- 

Boom Length
- 

Operating Radius
(see page 1)
- 

Boom Angle
(see page 1)
- 

Boom Point Elevation
(see page 1)
- 

Lifting Capacities
(see page 1)

REFERENCE ONLY!

MLC650 S-3

ASME B30.5

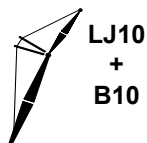

881,800 lb



360°

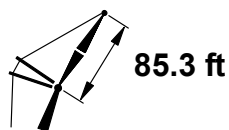

85.3 ft



140°

124.7 ft			
ft	°	ft	lb
22	84.3	133.8	773,600
24	83.4	133.5	773,600
26	82.4	133.2	773,600
28	81.5	132.8	773,600
30	80.6	132.4	773,600
32	79.6	132.0	773,600
34	78.7	131.6	773,600
36	77.8	131.1	773,600
38	76.8	130.5	750,200
40	75.8	130.0	712,500
45	73.4	128.4	629,300
50	71.0	126.6	535,200
55	68.5	124.5	457,500
60	66.0	122.2	393,500
65	63.4	119.6	340,000
70	60.7	116.7	294,400
75	58.0	113.5	255,000
80	55.2	109.9	220,500
85	52.3	106.0	190,100
90	49.2	101.5	162,900
95	46.0	96.6	138,400
100	42.5	91.1	116,100

144.4 ft			
ft	°	ft	lb
24	84.3	153.4	773,600
26	83.5	153.1	773,600
28	82.7	152.8	773,600
30	81.9	152.5	773,600
32	81.1	152.1	773,600
34	80.3	151.7	773,600
36	79.5	151.3	773,600
38	78.6	150.8	741,300
40	77.8	150.3	708,900
45	75.8	149.0	631,200
50	73.7	147.5	535,000
55	71.6	145.7	457,700
60	69.5	143.8	394,400
65	67.3	141.6	341,400
70	65.1	139.2	296,300
75	62.9	136.6	257,500
80	60.6	133.7	223,700
85	58.2	130.5	193,900
90	55.8	127.0	167,400
95	53.3	123.2	143,700
100	50.7	119.0	122,200
105	48.0	114.4	102,700
110	45.2	109.4	84,800
115	42.2	103.8	68,300

164.0 ft			
ft	°	ft	lb
24	85.0	173.2	773,600
26	84.3	173.0	773,600
28	83.6	172.7	773,600
30	82.9	172.4	773,600
32	82.2	172.1	773,600
34	81.4	171.7	773,600
36	80.7	171.4	767,100
38	80.0	171.0	732,800
40	79.3	170.6	701,300
45	77.5	169.4	627,700
50	75.7	168.0	531,900
55	73.9	166.5	455,000
60	72.0	164.8	392,000
65	70.2	163.0	339,300
70	68.3	160.9	294,600
75	66.4	158.6	256,200
80	64.4	156.2	222,700
85	62.5	153.5	193,300
90	60.4	150.6	167,200
95	58.4	147.4	143,900
100	56.3	144.0	122,900
105	54.1	140.3	103,900
110	51.8	136.3	86,500
115	49.5	132.0	70,600
120	47.1	127.3	55,900
125	44.6	122.2	42,300
130	42.0	116.6	29,500

MLC650 S-3

ASME B30.5

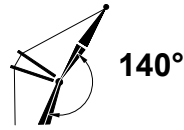
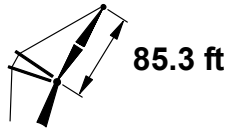
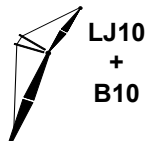

183.7 ft

ft	o	ft	lb
26	84.9	192.8	773,600
28	84.3	192.6	773,600
30	83.6	192.3	773,600
32	83.0	192.0	773,600
34	82.4	191.7	773,600
36	81.7	191.4	757,300
38	81.1	191.0	724,100
40	80.5	190.6	693,500
45	78.9	189.6	622,900
50	77.3	188.4	527,300
55	75.7	187.1	450,700
60	74.0	185.6	387,900
65	72.4	183.9	335,500
70	70.7	182.1	291,000
75	69.1	180.2	252,800
80	67.4	178.0	219,600
85	65.6	175.7	190,400
90	63.9	173.2	164,600
95	62.1	170.5	141,500
100	60.3	167.5	120,800
105	58.5	164.4	102,100
110	56.6	161.1	85,000
115	54.7	157.5	69,400
120	52.7	153.6	55,100
125	50.7	149.4	41,800
130	48.6	145.0	29,500
135	46.4	140.1	18,000

203.4 ft

ft	o	ft	lb
28	84.8	212.4	773,600
30	84.3	212.1	773,600
32	83.7	211.9	773,600
34	83.1	211.6	773,600
36	82.5	211.3	745,500
38	82.0	211.0	713,500
40	81.4	210.7	684,100
45	80.0	209.7	618,200
50	78.5	208.6	522,700
55	77.1	207.4	446,300
60	75.6	206.1	383,600
65	74.2	204.6	331,300
70	72.7	203.0	287,000
75	71.2	201.3	248,900
80	69.7	199.4	215,900
85	68.2	197.3	186,900
90	66.6	195.1	161,200
95	65.1	192.7	138,300
100	63.5	190.1	117,700
105	61.9	187.4	99,200
110	60.2	184.5	82,300
115	58.6	181.4	66,900
120	56.9	178.1	52,800
125	55.2	174.5	39,700
130	53.4	170.8	27,700

223.1 ft

ft	o	ft	lb
30	84.8	232.0	728,800
32	84.2	231.7	728,800
34	83.7	231.5	728,800
36	83.2	231.2	728,800
38	82.7	230.9	698,700
40	82.2	230.6	670,700
45	80.9	229.8	609,000
50	79.6	228.8	520,900
55	78.2	227.7	444,600
60	76.9	226.5	382,100
65	75.6	225.1	330,000
70	74.3	223.7	285,800
75	72.9	222.1	247,800
80	71.6	220.4	214,900
85	70.2	218.5	186,000
90	68.8	216.5	160,500
95	67.4	214.4	137,700
100	66.0	212.1	117,300
105	64.6	209.7	98,900
110	63.1	207.1	82,100
115	61.7	204.4	66,900
120	60.2	201.5	52,900
125	58.7	198.4	40,000
130	57.1	195.1	28,100
135	55.6	191.6	17,100

MLC650 S-3

ASME B30.5

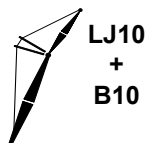

881,800 lb

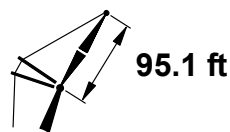

95.1 ft

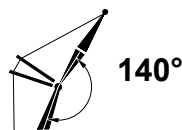

140°

124.7 ft

ft	o	ft	lb
22	84.3	133.8	773,600
24	83.4	133.5	773,600
26	82.4	133.2	773,600
28	81.5	132.8	773,600
30	80.6	132.4	773,600
32	79.6	132.0	773,600
34	78.7	131.6	773,600
36	77.8	131.1	773,600
38	76.8	130.5	744,300
40	75.8	130.0	705,500
45	73.4	128.4	607,800
50	71.0	126.6	512,600
55	68.5	124.5	436,200
60	66.0	122.2	373,400
65	63.4	119.6	320,800
70	60.7	116.7	276,000
75	58.0	113.5	237,300
80	55.2	109.9	203,600
85	52.3	106.0	173,700
90	49.2	101.5	147,100
95	46.0	96.6	123,100
100	42.5	91.1	101,200

144.4 ft

ft	o	ft	lb
24	84.3	153.4	773,600
26	83.5	153.1	773,600
28	82.7	152.8	773,600
30	81.9	152.5	773,600
32	81.1	152.1	773,600
34	80.3	151.7	773,600
36	79.5	151.3	773,600
38	78.6	150.8	741,300
40	77.8	150.3	708,000
45	75.8	149.0	607,500
50	73.7	147.5	512,900
55	71.6	145.7	437,000
60	69.5	143.8	374,700
65	67.3	141.6	322,700
70	65.1	139.2	278,400
75	62.9	136.6	240,300
80	60.6	133.7	207,100
85	58.2	130.5	177,900
90	55.8	127.0	151,900
95	53.3	123.2	128,600
100	50.7	119.0	107,600
105	48.0	114.4	88,500
110	45.2	109.4	71,000
115	42.2	103.8	54,800

164.0 ft

ft	o	ft	lb
24	85.0	173.2	773,600
26	84.3	173.0	773,600
28	83.6	172.7	773,600
30	82.9	172.4	773,600
32	82.2	172.1	773,600
34	81.4	171.7	773,600
36	80.7	171.4	767,100
38	80.0	171.0	732,800
40	79.3	170.6	701,300
45	77.5	169.4	604,500
50	75.7	168.0	510,300
55	73.9	166.5	434,700
60	72.0	164.8	372,800
65	70.2	163.0	321,000
70	68.3	160.9	277,100
75	66.4	158.6	239,400
80	64.4	156.2	206,500
85	62.5	153.5	177,600
90	60.4	150.6	152,000
95	58.4	147.4	129,100
100	56.3	144.0	108,500
105	54.1	140.3	89,900
110	51.8	136.3	72,900
115	49.5	132.0	57,300
120	47.1	127.3	42,900
125	44.6	122.2	29,500
130	42.0	116.6	17,100

MLC650 S-3

ASME B30.5

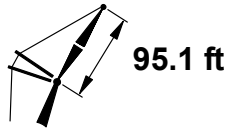
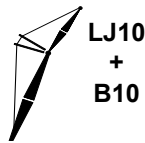

183.7 ft

ft	o	ft	lb
26	84.9	192.8	773,600
28	84.3	192.6	773,600
30	83.6	192.3	773,600
32	83.0	192.0	773,600
34	82.4	191.7	773,600
36	81.7	191.4	757,300
38	81.1	191.0	724,100
40	80.5	190.6	693,500
45	78.9	189.6	600,000
50	77.3	188.4	506,000
55	75.7	187.1	430,800
60	74.0	185.6	369,000
65	72.4	183.9	317,500
70	70.7	182.1	273,800
75	69.1	180.2	236,300
80	67.4	178.0	203,700
85	65.6	175.7	175,000
90	63.9	173.2	149,700
95	62.1	170.5	127,000
100	60.3	167.5	106,700
105	58.5	164.4	88,300
110	56.6	161.1	71,600
115	54.7	157.5	56,300
120	52.7	153.6	42,200
125	50.7	149.4	29,200
130	48.6	145.0	17,200

203.4 ft

ft	o	ft	lb
28	84.8	212.4	773,600
30	84.3	212.1	773,600
32	83.7	211.9	773,600
34	83.1	211.6	773,600
36	82.5	211.3	745,500
38	82.0	211.0	713,500
40	81.4	210.7	684,100
45	80.0	209.7	595,600
50	78.5	208.6	501,800
55	77.1	207.4	426,600
60	75.6	206.1	365,100
65	74.2	204.6	313,700
70	72.7	203.0	270,100
75	71.2	201.3	232,700
80	69.7	199.4	200,200
85	68.2	197.3	171,700
90	66.6	195.1	146,500
95	65.1	192.7	124,000
100	63.5	190.1	103,800
105	61.9	187.4	85,600
110	60.2	184.5	69,100
115	58.6	181.4	53,900
120	56.9	178.1	40,100
125	55.2	174.5	27,300

223.1 ft

ft	o	ft	lb
30	84.8	232.0	728,800
32	84.2	231.7	728,800
34	83.7	231.5	728,800
36	83.2	231.2	728,800
38	82.7	230.9	698,700
40	82.2	230.6	670,700
45	80.9	229.8	593,800
50	79.6	228.8	500,200
55	78.2	227.7	425,200
60	76.9	226.5	363,800
65	75.6	225.1	312,500
70	74.3	223.7	269,100
75	72.9	222.1	231,800
80	71.6	220.4	199,500
85	70.2	218.5	171,100
90	68.8	216.5	146,000
95	67.4	214.4	123,700
100	66.0	212.1	103,600
105	64.6	209.7	85,500
110	63.1	207.1	69,100
115	61.7	204.4	54,100
120	60.2	201.5	40,400
125	58.7	198.4	27,700

MLC650 S-3

ASME B30.5

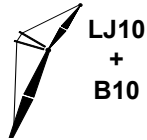

881,800 lb

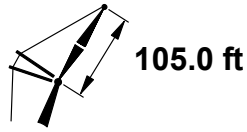

105.0 ft

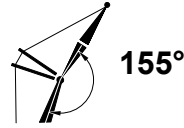

155°

124.7 ft

ft	o	ft	lb
22	84.3	133.8	773,600
24	83.4	133.5	773,600
26	82.4	133.2	773,600
28	81.5	132.8	773,600
30	80.6	132.4	773,600
32	79.6	132.0	773,600
34	78.7	131.6	773,600
36	77.8	131.1	773,600
38	76.8	130.5	750,200
40	75.8	130.0	715,000
45	73.4	128.4	625,100
50	71.0	126.6	525,800
55	68.5	124.5	446,100
60	66.0	122.2	380,500
65	63.4	119.6	325,500
70	60.7	116.7	278,700
75	58.0	113.5	238,200
80	55.2	109.9	202,800
85	52.3	106.0	171,500
90	49.2	101.5	143,500
95	46.0	96.6	118,200
100	42.5	91.1	95,200
105	38.9	84.8	73,900
110	34.8	77.6	54,100
115	30.3	69.1	35,300

144.4 ft

ft	o	ft	lb
24	84.3	153.4	773,600
26	83.5	153.1	773,600
28	82.7	152.8	773,600
30	81.9	152.5	773,600
32	81.1	152.1	773,600
34	80.3	151.7	773,600
36	79.5	151.3	773,600
38	78.6	150.8	741,300
40	77.8	150.3	708,900
45	75.8	149.0	626,800
50	73.7	147.5	528,200
55	71.6	145.7	449,100
60	69.5	143.8	384,100
65	67.3	141.6	329,800
70	65.1	139.2	283,600
75	62.9	136.6	243,700
80	60.6	133.7	209,000
85	58.2	130.5	178,400
90	55.8	127.0	151,200
95	53.3	123.2	126,800
100	50.7	119.0	104,800
105	48.0	114.4	84,700
110	45.2	109.4	66,200
115	42.2	103.8	49,200
120	39.1	97.6	33,300
125	35.7	90.6	18,300

164.0 ft

ft	o	ft	lb
24	85.0	173.2	773,600
26	84.3	173.0	773,600
28	83.6	172.7	773,600
30	82.9	172.4	773,600
32	82.2	172.1	773,600
34	81.4	171.7	773,600
36	80.7	171.4	767,100
38	80.0	171.0	732,800
40	79.3	170.6	701,300
45	77.5	169.4	625,300
50	75.7	168.0	527,100
55	73.9	166.5	448,400
60	72.0	164.8	383,800
65	70.2	163.0	329,900
70	68.3	160.9	284,100
75	66.4	158.6	244,600
80	64.4	156.2	210,300
85	62.5	153.5	180,200
90	60.4	150.6	153,400
95	58.4	147.4	129,500
100	56.3	144.0	107,900
105	54.1	140.3	88,300
110	51.8	136.3	70,500
115	49.5	132.0	54,100
120	47.1	127.3	39,000
125	44.6	122.2	24,900

MLC650 S-3

ASME B30.5

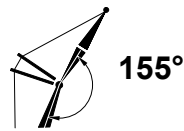
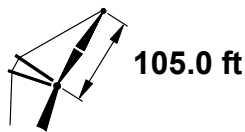
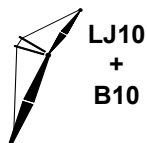

183.7 ft

ft	o	ft	lb
26	84.9	192.8	773,600
28	84.3	192.6	773,600
30	83.6	192.3	773,600
32	83.0	192.0	773,600
34	82.4	191.7	773,600
36	81.7	191.4	757,300
38	81.1	191.0	724,100
40	80.5	190.6	693,500
45	78.9	189.6	621,900
50	77.3	188.4	524,100
55	75.7	187.1	445,700
60	74.0	185.6	381,400
65	72.4	183.9	327,700
70	70.7	182.1	282,100
75	69.1	180.2	243,000
80	67.4	178.0	208,900
85	65.6	175.7	179,000
90	63.9	173.2	152,500
95	62.1	170.5	128,900
100	60.3	167.5	107,600
105	58.5	164.4	88,400
110	56.6	161.1	70,900
115	54.7	157.5	54,900
120	52.7	153.6	40,100
125	50.7	149.4	26,500

203.4 ft

ft	o	ft	lb
28	84.8	212.4	773,600
30	84.3	212.1	773,600
32	83.7	211.9	773,600
34	83.1	211.6	773,600
36	82.5	211.3	745,500
38	82.0	211.0	713,500
40	81.4	210.7	684,100
45	80.0	209.7	618,500
50	78.5	208.6	520,800
55	77.1	207.4	442,500
60	75.6	206.1	378,400
65	74.2	204.6	324,800
70	72.7	203.0	279,500
75	71.2	201.3	240,500
80	69.7	199.4	206,600
85	68.2	197.3	176,900
90	66.6	195.1	150,500
95	65.1	192.7	127,100
100	63.5	190.1	106,000
105	61.9	187.4	87,000
110	60.2	184.5	69,700
115	58.6	181.4	53,900
120	56.9	178.1	39,300
125	55.2	174.5	26,000

223.1 ft

ft	o	ft	lb
30	84.8	232.0	728,800
32	84.2	231.7	728,800
34	83.7	231.5	728,800
36	83.2	231.2	728,800
38	82.7	230.9	698,700
40	82.2	230.6	670,700
45	80.9	229.8	609,000
50	79.6	228.8	519,900
55	78.2	227.7	441,900
60	76.9	226.5	377,900
65	75.6	225.1	324,500
70	74.3	223.7	279,300
75	72.9	222.1	240,500
80	71.6	220.4	206,700
85	70.2	218.5	177,100
90	68.8	216.5	151,000
95	67.4	214.4	127,700
100	66.0	212.1	106,700
105	64.6	209.7	87,900
110	63.1	207.1	70,700
115	61.7	204.4	55,100
120	60.2	201.5	40,700
125	58.7	198.4	27,500

MLC650 S-3

ASME B30.5

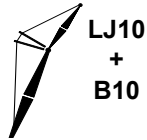

881,800 lb



360°

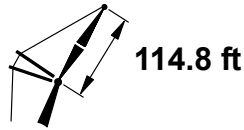

114.8 ft

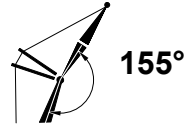

155°

124.7 ft

ft	o	ft	lb
22	84.3	133.8	773,600
24	83.4	133.5	773,600
26	82.4	133.2	773,600
28	81.5	132.8	773,600
30	80.6	132.4	773,600
32	79.6	132.0	773,600
34	78.7	131.6	773,600
36	77.8	131.1	773,600
38	76.8	130.5	749,200
40	75.8	130.0	709,600
45	73.4	128.4	603,600
50	71.0	126.6	505,400
55	68.5	124.5	426,600
60	66.0	122.2	361,700
65	63.4	119.6	307,400
70	60.7	116.7	261,100
75	58.0	113.5	221,100
80	55.2	109.9	186,200
85	52.3	106.0	155,300
90	49.2	101.5	127,600
95	46.0	96.6	102,700
100	42.5	91.1	80,000
105	38.9	84.8	59,100
110	34.8	77.6	39,600
115	30.3	69.1	21,100

144.4 ft

ft	o	ft	lb
24	84.3	153.4	773,600
26	83.5	153.1	773,600
28	82.7	152.8	773,600
30	81.9	152.5	773,600
32	81.1	152.1	773,600
34	80.3	151.7	773,600
36	79.5	151.3	773,600
38	78.6	150.8	741,300
40	77.8	150.3	708,900
45	75.8	149.0	606,100
50	73.7	147.5	508,600
55	71.6	145.7	430,400
60	69.5	143.8	366,200
65	67.3	141.6	312,400
70	65.1	139.2	266,800
75	62.9	136.6	227,400
80	60.6	133.7	193,100
85	58.2	130.5	162,900
90	55.8	127.0	136,100
95	53.3	123.2	112,000
100	50.7	119.0	90,200
105	48.0	114.4	70,400
110	45.2	109.4	52,200
115	42.2	103.8	35,400
120	39.1	97.6	19,700

164.0 ft

ft	o	ft	lb
24	85.0	173.2	773,600
26	84.3	173.0	773,600
28	83.6	172.7	773,600
30	82.9	172.4	773,600
32	82.2	172.1	773,600
34	81.4	171.7	773,600
36	80.7	171.4	767,100
38	80.0	171.0	732,800
40	79.3	170.6	701,300
45	77.5	169.4	605,200
50	75.7	168.0	508,200
55	73.9	166.5	430,300
60	72.0	164.8	366,500
65	70.2	163.0	313,200
70	68.3	160.9	267,900
75	66.4	158.6	228,900
80	64.4	156.2	195,000
85	62.5	153.5	165,200
90	60.4	150.6	138,800
95	58.4	147.4	115,100
100	56.3	144.0	93,800
105	54.1	140.3	74,500
110	51.8	136.3	56,900
115	49.5	132.0	40,800
120	47.1	127.3	25,800

MLC650 S-3

ASME B30.5

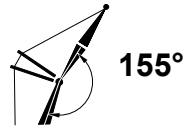
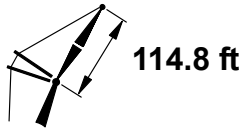
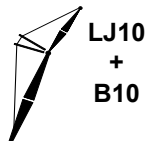

183.7 ft

ft	o	ft	lb
26	84.9	192.8	773,600
28	84.3	192.6	773,600
30	83.6	192.3	773,600
32	83.0	192.0	773,600
34	82.4	191.7	773,600
36	81.7	191.4	757,300
38	81.1	191.0	724,100
40	80.5	190.6	693,500
45	78.9	189.6	602,400
50	77.3	188.4	505,600
55	75.7	187.1	428,100
60	74.0	185.6	364,500
65	72.4	183.9	311,500
70	70.7	182.1	266,400
75	69.1	180.2	227,700
80	67.4	178.0	194,100
85	65.6	175.7	164,500
90	63.9	173.2	138,400
95	62.1	170.5	115,000
100	60.3	167.5	94,000
105	58.5	164.4	75,000
110	56.6	161.1	57,700
115	54.7	157.5	41,900
120	52.7	153.6	27,400

203.4 ft

ft	o	ft	lb
28	84.8	212.4	773,600
30	84.3	212.1	773,600
32	83.7	211.9	773,600
34	83.1	211.6	773,600
36	82.5	211.3	745,500
38	82.0	211.0	713,500
40	81.4	210.7	684,100
45	80.0	209.7	599,300
50	78.5	208.6	502,700
55	77.1	207.4	425,400
60	75.6	206.1	362,000
65	74.2	204.6	309,000
70	72.7	203.0	264,200
75	71.2	201.3	225,600
80	69.7	199.4	192,200
85	68.2	197.3	162,800
90	66.6	195.1	136,800
95	65.1	192.7	113,600
100	63.5	190.1	92,800
105	61.9	187.4	74,000
110	60.2	184.5	56,900
115	58.6	181.4	41,300
120	56.9	178.1	26,900

223.1 ft

ft	o	ft	lb
30	84.8	232.0	728,800
32	84.2	231.7	728,800
34	83.7	231.5	728,800
36	83.2	231.2	728,800
38	82.7	230.9	698,700
40	82.2	230.6	670,700
45	80.9	229.8	598,600
50	79.6	228.8	502,200
55	78.2	227.7	425,100
60	76.9	226.5	361,800
65	75.6	225.1	309,100
70	74.3	223.7	264,400
75	72.9	222.1	226,000
80	71.6	220.4	192,600
85	70.2	218.5	163,400
90	68.8	216.5	137,500
95	67.4	214.4	114,500
100	66.0	212.1	93,800
105	64.6	209.7	75,200
110	63.1	207.1	58,200
115	61.7	204.4	42,800
120	60.2	201.5	28,600

MLC650 S-3

ASME B30.5

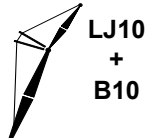

881,800 lb

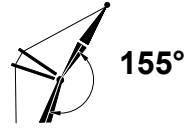
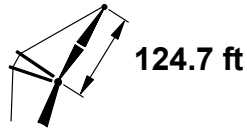

124.7 ft

ft	o	ft	lb
22	84.3	133.8	773,600
24	83.4	133.5	773,600
26	82.4	133.2	773,600
28	81.5	132.8	773,600
30	80.6	132.4	773,600
32	79.6	132.0	773,600
34	78.7	131.6	773,600
36	77.8	131.1	773,600
38	76.8	130.5	743,300
40	75.8	130.0	703,900
45	73.4	128.4	590,500
50	71.0	126.6	493,200
55	68.5	124.5	415,100
60	66.0	122.2	350,800
65	63.4	119.6	297,000
70	60.7	116.7	251,100
75	58.0	113.5	211,500
80	55.2	109.9	176,900
85	52.3	106.0	146,300
90	49.2	101.5	118,900
95	46.0	96.6	94,300
100	42.5	91.1	71,800
105	38.9	84.8	51,100
110	34.8	77.6	31,900

144.4 ft

ft	o	ft	lb
24	84.3	153.4	773,600
26	83.5	153.1	773,600
28	82.7	152.8	773,600
30	81.9	152.5	773,600
32	81.1	152.1	773,600
34	80.3	151.7	773,600
36	79.5	151.3	773,600
38	78.6	150.8	741,300
40	77.8	150.3	707,700
45	75.8	149.0	593,700
50	73.7	147.5	497,000
55	71.6	145.7	419,500
60	69.5	143.8	355,800
65	67.3	141.6	302,600
70	65.1	139.2	257,300
75	62.9	136.6	218,400
80	60.6	133.7	184,400
85	58.2	130.5	154,500
90	55.8	127.0	127,900
95	53.3	123.2	104,000
100	50.7	119.0	82,500
105	48.0	114.4	62,800
110	45.2	109.4	44,900
115	42.2	103.8	28,200

164.0 ft

ft	o	ft	lb
24	85.0	173.2	773,600
26	84.3	173.0	773,600
28	83.6	172.7	773,600
30	82.9	172.4	773,600
32	82.2	172.1	773,600
34	81.4	171.7	773,600
36	80.7	171.4	767,100
38	80.0	171.0	732,800
40	79.3	170.6	701,300
45	77.5	169.4	593,200
50	75.7	168.0	497,000
55	73.9	166.5	419,900
60	72.0	164.8	356,600
65	70.2	163.0	303,800
70	68.3	160.9	258,900
75	66.4	158.6	220,300
80	64.4	156.2	186,700
85	62.5	153.5	157,200
90	60.4	150.6	131,000
95	58.4	147.4	107,600
100	56.3	144.0	86,500
105	54.1	140.3	67,400
110	51.8	136.3	49,900
115	49.5	132.0	33,900
120	47.1	127.3	19,200

MLC650 S-3

ASME B30.5

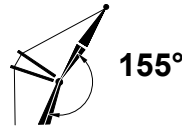
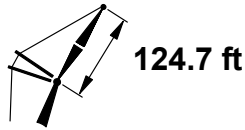
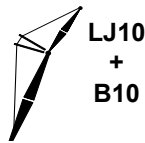

183.7 ft

ft	o	ft	lb
26	84.9	192.8	773,600
28	84.3	192.6	773,600
30	83.6	192.3	773,600
32	83.0	192.0	773,600
34	82.4	191.7	773,600
36	81.7	191.4	757,300
38	81.1	191.0	724,100
40	80.5	190.6	693,500
45	78.9	189.6	590,700
50	77.3	188.4	494,800
55	75.7	187.1	418,000
60	74.0	185.6	355,000
65	72.4	183.9	302,400
70	70.7	182.1	257,800
75	69.1	180.2	219,400
80	67.4	178.0	186,100
85	65.6	175.7	156,800
90	63.9	173.2	130,900
95	62.1	170.5	107,800
100	60.3	167.5	87,000
105	58.5	164.4	68,200
110	56.6	161.1	51,100
115	54.7	157.5	35,400
120	52.7	153.6	21,000

203.4 ft

ft	o	ft	lb
28	84.8	212.4	773,600
30	84.3	212.1	773,600
32	83.7	211.9	773,600
34	83.1	211.6	773,600
36	82.5	211.3	745,500
38	82.0	211.0	713,500
40	81.4	210.7	684,100
45	80.0	209.7	588,000
50	78.5	208.6	492,300
55	77.1	207.4	415,600
60	75.6	206.1	352,700
65	74.2	204.6	300,300
70	72.7	203.0	255,800
75	71.2	201.3	217,600
80	69.7	199.4	184,500
85	68.2	197.3	155,300
90	66.6	195.1	129,600
95	65.1	192.7	106,600
100	63.5	190.1	86,000
105	61.9	187.4	67,400
110	60.2	184.5	50,400
115	58.6	181.4	35,000
120	56.9	178.1	20,800

223.1 ft

ft	o	ft	lb
30	84.8	232.0	728,800
32	84.2	231.7	728,800
34	83.7	231.5	728,800
36	83.2	231.2	728,800
38	82.7	230.9	698,700
40	82.2	230.6	670,700
45	80.9	229.8	587,500
50	79.6	228.8	492,000
55	78.2	227.7	415,500
60	76.9	226.5	352,900
65	75.6	225.1	300,600
70	74.3	223.7	256,200
75	72.9	222.1	218,200
80	71.6	220.4	185,200
85	70.2	218.5	156,200
90	68.8	216.5	130,600
95	67.4	214.4	107,800
100	66.0	212.1	87,300
105	64.6	209.7	68,800
110	63.1	207.1	52,000
115	61.7	204.4	36,700
120	60.2	201.5	22,700

MLC650 S-3

ASME B30.5

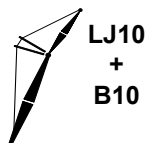

881,800 lb

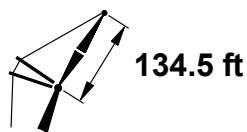

134.5 ft

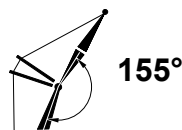

155°

124.7 ft

ft	o	ft	lb
22	84.3	133.8	773,600
24	83.4	133.5	773,600
26	82.4	133.2	773,600
28	81.5	132.8	773,600
30	80.6	132.4	773,600
32	79.6	132.0	773,600
34	78.7	131.6	773,600
36	77.8	131.1	773,600
38	76.8	130.5	737,700
40	75.8	130.0	691,200
45	73.4	128.4	568,000
50	71.0	126.6	471,900
55	68.5	124.5	394,700
60	66.0	122.2	331,300
65	63.4	119.6	278,100
70	60.7	116.7	232,800
75	58.0	113.5	193,700
80	55.2	109.9	159,600
85	52.3	106.0	129,400
90	49.2	101.5	102,400
95	46.0	96.6	78,100
100	42.5	91.1	56,000
105	38.9	84.8	35,700

144.4 ft

ft	o	ft	lb
24	84.3	153.4	773,600
26	83.5	153.1	773,600
28	82.7	152.8	773,600
30	81.9	152.5	773,600
32	81.1	152.1	773,600
34	80.3	151.7	773,600
36	79.5	151.3	773,600
38	78.6	150.8	741,300
40	77.8	150.3	694,500
45	75.8	149.0	572,100
50	73.7	147.5	476,600
55	71.6	145.7	400,000
60	69.5	143.8	337,100
65	67.3	141.6	284,500
70	65.1	139.2	239,900
75	62.9	136.6	201,400
80	60.6	133.7	167,800
85	58.2	130.5	138,300
90	55.8	127.0	112,100
95	53.3	123.2	88,600
100	50.7	119.0	67,300
105	48.0	114.4	48,000
110	45.2	109.4	30,300

164.0 ft

ft	o	ft	lb
24	85.0	173.2	773,600
26	84.3	173.0	773,600
28	83.6	172.7	773,600
30	82.9	172.4	773,600
32	82.2	172.1	773,600
34	81.4	171.7	773,600
36	80.7	171.4	767,100
38	80.0	171.0	732,800
40	79.3	170.6	694,300
45	77.5	169.4	572,300
50	75.7	168.0	477,300
55	73.9	166.5	401,100
60	72.0	164.8	338,600
65	70.2	163.0	286,400
70	68.3	160.9	242,100
75	66.4	158.6	203,900
80	64.4	156.2	170,800
85	62.5	153.5	141,600
90	60.4	150.6	115,800
95	58.4	147.4	92,700
100	56.3	144.0	71,900
105	54.1	140.3	53,100
110	51.8	136.3	35,900
115	49.5	132.0	20,100

MLC650 S-3

ASME B30.5

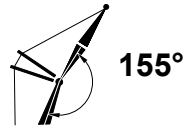
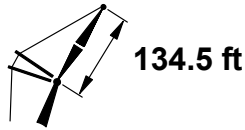
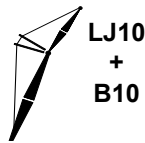

183.7 ft

ft	o	ft	lb
26	84.9	192.8	773,600
28	84.3	192.6	773,600
30	83.6	192.3	773,600
32	83.0	192.0	773,600
34	82.4	191.7	773,600
36	81.7	191.4	757,300
38	81.1	191.0	724,100
40	80.5	190.6	692,000
45	78.9	189.6	570,300
50	77.3	188.4	475,600
55	75.7	187.1	399,700
60	74.0	185.6	337,500
65	72.4	183.9	285,500
70	70.7	182.1	241,500
75	69.1	180.2	203,600
80	67.4	178.0	170,700
85	65.6	175.7	141,800
90	63.9	173.2	116,200
95	62.1	170.5	93,400
100	60.3	167.5	72,900
105	58.5	164.4	54,300
110	56.6	161.1	37,400
115	54.7	157.5	22,000

203.4 ft

ft	o	ft	lb
28	84.8	212.4	773,600
30	84.3	212.1	773,600
32	83.7	211.9	773,600
34	83.1	211.6	773,600
36	82.5	211.3	745,500
38	82.0	211.0	713,500
40	81.4	210.7	684,100
45	80.0	209.7	568,000
50	78.5	208.6	473,500
55	77.1	207.4	397,700
60	75.6	206.1	335,600
65	74.2	204.6	283,800
70	72.7	203.0	239,900
75	71.2	201.3	202,200
80	69.7	199.4	169,500
85	68.2	197.3	140,700
90	66.6	195.1	115,300
95	65.1	192.7	92,600
100	63.5	190.1	72,300
105	61.9	187.4	53,900
110	60.2	184.5	37,200
115	58.6	181.4	22,000

223.1 ft

ft	o	ft	lb
30	84.8	232.0	728,800
32	84.2	231.7	728,800
34	83.7	231.5	728,800
36	83.2	231.2	728,800
38	82.7	230.9	698,700
40	82.2	230.6	670,700
45	80.9	229.8	567,900
50	79.6	228.8	473,600
55	78.2	227.7	398,000
60	76.9	226.5	336,100
65	75.6	225.1	284,500
70	74.3	223.7	240,700
75	72.9	222.1	203,200
80	71.6	220.4	170,500
85	70.2	218.5	141,900
90	68.8	216.5	116,600
95	67.4	214.4	94,100
100	66.0	212.1	73,900
105	64.6	209.7	55,700
110	63.1	207.1	39,100
115	61.7	204.4	24,000

MLC650 S-3

ASME B30.5

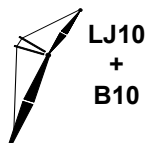

881,800 lb

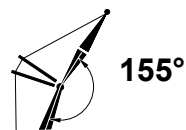
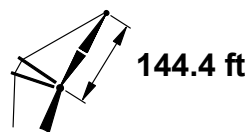

124.7 ft

ft	o	ft	lb
22	84.3	133.8	773,600
24	83.4	133.5	773,600
26	82.4	133.2	773,600
28	81.5	132.8	773,600
30	80.6	132.4	773,600
32	79.6	132.0	773,600
34	78.7	131.6	773,600
36	77.8	131.1	773,600
38	76.8	130.5	728,200
40	75.8	130.0	669,300
45	73.4	128.4	547,600
50	71.0	126.6	452,700
55	68.5	124.5	376,400
60	66.0	122.2	313,800
65	63.4	119.6	261,300
70	60.7	116.7	216,600
75	58.0	113.5	178,100
80	55.2	109.9	144,400
85	52.3	106.0	114,600
90	49.2	101.5	88,100
95	46.0	96.6	64,100
100	42.5	91.1	42,400
105	38.9	84.8	22,300

144.4 ft

ft	o	ft	lb
24	84.3	153.4	773,600
26	83.5	153.1	773,600
28	82.7	152.8	773,600
30	81.9	152.5	773,600
32	81.1	152.1	773,600
34	80.3	151.7	773,600
36	79.5	151.3	773,600
38	78.6	150.8	732,000
40	77.8	150.3	673,500
45	75.8	149.0	552,500
50	73.7	147.5	458,200
55	71.6	145.7	382,500
60	69.5	143.8	320,500
65	67.3	141.6	268,600
70	65.1	139.2	224,500
75	62.9	136.6	186,500
80	60.6	133.7	153,400
85	58.2	130.5	124,300
90	55.8	127.0	98,400
95	53.3	123.2	75,200
100	50.7	119.0	54,300
105	48.0	114.4	35,200
110	45.2	109.4	17,800

164.0 ft

ft	o	ft	lb
24	85.0	173.2	773,600
26	84.3	173.0	773,600
28	83.6	172.7	773,600
30	82.9	172.4	773,600
32	82.2	172.1	773,600
34	81.4	171.7	773,600
36	80.7	171.4	767,100
38	80.0	171.0	732,200
40	79.3	170.6	673,900
45	77.5	169.4	553,400
50	75.7	168.0	459,500
55	73.9	166.5	384,300
60	72.0	164.8	322,600
65	70.2	163.0	271,000
70	68.3	160.9	227,300
75	66.4	158.6	189,600
80	64.4	156.2	156,900
85	62.5	153.5	128,100
90	60.4	150.6	102,700
95	58.4	147.4	79,900
100	56.3	144.0	59,400
105	54.1	140.3	40,800
110	51.8	136.3	23,800

MLC650 S-3

ASME B30.5

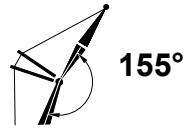
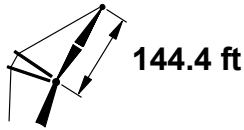
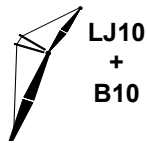

183.7 ft

ft	o	ft	lb
26	84.9	192.8	773,600
28	84.3	192.6	773,600
30	83.6	192.3	773,600
32	83.0	192.0	773,600
34	82.4	191.7	773,600
36	81.7	191.4	757,300
38	81.1	191.0	724,100
40	80.5	190.6	672,100
45	78.9	189.6	551,900
50	77.3	188.4	458,400
55	75.7	187.1	383,400
60	74.0	185.6	322,000
65	72.4	183.9	270,700
70	70.7	182.1	227,200
75	69.1	180.2	189,800
80	67.4	178.0	157,300
85	65.6	175.7	128,800
90	63.9	173.2	103,500
95	62.1	170.5	81,000
100	60.3	167.5	60,800
105	58.5	164.4	42,500
110	56.6	161.1	25,800

203.4 ft

ft	o	ft	lb
28	84.8	212.4	773,600
30	84.3	212.1	773,600
32	83.7	211.9	773,600
34	83.1	211.6	773,600
36	82.5	211.3	745,500
38	82.0	211.0	713,500
40	81.4	210.7	670,000
45	80.0	209.7	550,000
50	78.5	208.6	456,600
55	77.1	207.4	381,800
60	75.6	206.1	320,500
65	74.2	204.6	269,400
70	72.7	203.0	226,000
75	71.2	201.3	188,800
80	69.7	199.4	156,500
85	68.2	197.3	128,100
90	66.6	195.1	103,000
95	65.1	192.7	80,700
100	63.5	190.1	60,600
105	61.9	187.4	42,400
110	60.2	184.5	26,000

223.1 ft

ft	o	ft	lb
30	84.8	232.0	728,800
32	84.2	231.7	728,800
34	83.7	231.5	728,800
36	83.2	231.2	728,800
38	82.7	230.9	698,700
40	82.2	230.6	668,900
45	80.9	229.8	550,300
50	79.6	228.8	457,100
55	78.2	227.7	382,500
60	76.9	226.5	321,400
65	75.6	225.1	270,400
70	74.3	223.7	227,200
75	72.9	222.1	190,100
80	71.6	220.4	157,900
85	70.2	218.5	129,700
90	68.8	216.5	104,700
95	67.4	214.4	82,500
100	66.0	212.1	62,500
105	64.6	209.7	44,500
110	63.1	207.1	28,200

MLC650 S-3

ASME B30.5

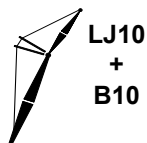

881,800 lb



360°

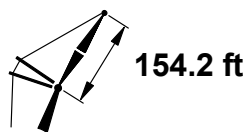

154.2 ft

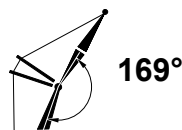

169°

124.7 ft

ft	o	ft	lb
22	84.3	133.8	773,600
24	83.4	133.5	773,600
26	82.4	133.2	773,600
28	81.5	132.8	773,600
30	80.6	132.4	773,600
32	79.6	132.0	773,600
34	78.7	131.6	773,600
36	77.8	131.1	773,600
38	76.8	130.5	750,200
40	75.8	130.0	716,400
45	73.4	128.4	593,100
50	71.0	126.6	490,100
55	68.5	124.5	407,300
60	66.0	122.2	339,200
65	63.4	119.6	282,100
70	60.7	116.7	233,400
75	58.0	113.5	191,300
80	55.2	109.9	154,500
85	52.3	106.0	121,800
90	49.2	101.5	92,600
95	46.0	96.6	66,200
100	42.5	91.1	42,100
105	38.9	84.8	19,800

144.4 ft

ft	o	ft	lb
24	84.3	153.4	773,600
26	83.5	153.1	773,600
28	82.7	152.8	773,600
30	81.9	152.5	773,600
32	81.1	152.1	773,600
34	80.3	151.7	773,600
36	79.5	151.3	773,600
38	78.6	150.8	741,300
40	77.8	150.3	708,900
45	75.8	149.0	600,500
50	73.7	147.5	498,300
55	71.6	145.7	416,300
60	69.5	143.8	349,000
65	67.3	141.6	292,600
70	65.1	139.2	244,700
75	62.9	136.6	203,300
80	60.6	133.7	167,300
85	58.2	130.5	135,500
90	55.8	127.0	107,200
95	53.3	123.2	81,800
100	50.7	119.0	58,800
105	48.0	114.4	37,800
110	45.2	109.4	18,500

164.0 ft

ft	o	ft	lb
24	85.0	173.2	773,600
26	84.3	173.0	773,600
28	83.6	172.7	773,600
30	82.9	172.4	773,600
32	82.2	172.1	773,600
34	81.4	171.7	773,600
36	80.7	171.4	767,100
38	80.0	171.0	732,800
40	79.3	170.6	701,300
45	77.5	169.4	603,300
50	75.7	168.0	501,700
55	73.9	166.5	420,200
60	72.0	164.8	353,300
65	70.2	163.0	297,400
70	68.3	160.9	249,900
75	66.4	158.6	209,000
80	64.4	156.2	173,400
85	62.5	153.5	142,100
90	60.4	150.6	114,300
95	58.4	147.4	89,500
100	56.3	144.0	67,000
105	54.1	140.3	46,700
110	51.8	136.3	28,100

MLC650 S-3

ASME B30.5

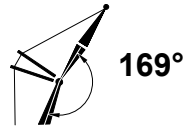
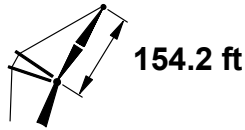
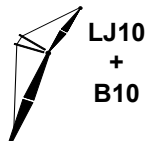

183.7 ft

ft	o	ft	lb
26	84.9	192.8	773,600
28	84.3	192.6	773,600
30	83.6	192.3	773,600
32	83.0	192.0	773,600
34	82.4	191.7	773,600
36	81.7	191.4	757,300
38	81.1	191.0	724,100
40	80.5	190.6	693,500
45	78.9	189.6	603,300
50	77.3	188.4	502,000
55	75.7	187.1	420,900
60	74.0	185.6	354,300
65	72.4	183.9	298,800
70	70.7	182.1	251,600
75	69.1	180.2	211,000
80	67.4	178.0	175,800
85	65.6	175.7	144,800
90	63.9	173.2	117,300
95	62.1	170.5	92,800
100	60.3	167.5	70,700
105	58.5	164.4	50,800
110	56.6	161.1	32,600

203.4 ft

ft	o	ft	lb
28	84.8	212.4	773,600
30	84.3	212.1	773,600
32	83.7	211.9	773,600
34	83.1	211.6	773,600
36	82.5	211.3	745,500
38	82.0	211.0	713,500
40	81.4	210.7	684,100
45	80.0	209.7	602,500
50	78.5	208.6	501,500
55	77.1	207.4	420,600
60	75.6	206.1	354,200
65	74.2	204.6	298,800
70	72.7	203.0	251,900
75	71.2	201.3	211,500
80	69.7	199.4	176,400
85	68.2	197.3	145,600
90	66.6	195.1	118,400
95	65.1	192.7	94,100
100	63.5	190.1	72,200
105	61.9	187.4	52,500
110	60.2	184.5	34,500
115	58.6	181.4	18,100

223.1 ft

ft	o	ft	lb
30	84.8	232.0	728,800
32	84.2	231.7	728,800
34	83.7	231.5	728,800
36	83.2	231.2	728,800
38	82.7	230.9	698,700
40	82.2	230.6	670,700
45	80.9	229.8	603,700
50	79.6	228.8	502,900
55	78.2	227.7	422,200
60	76.9	226.5	356,100
65	75.6	225.1	300,900
70	74.3	223.7	254,100
75	72.9	222.1	213,900
80	71.6	220.4	179,000
85	70.2	218.5	148,400
90	68.8	216.5	121,300
95	67.4	214.4	97,200
100	66.0	212.1	75,500
105	64.6	209.7	55,900
110	63.1	207.1	38,100
115	61.7	204.4	21,900

MLC650 S-3

ASME B30.5

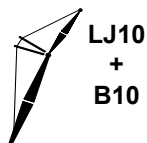

881,800 lb



360°

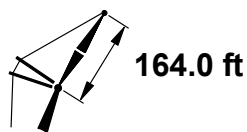

164.0 ft

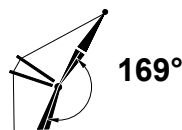

169°

124.7 ft

ft	o	ft	lb
22	84.3	133.8	773,600
24	83.4	133.5	773,600
26	82.4	133.2	773,600
28	81.5	132.8	773,600
30	80.6	132.4	773,600
32	79.6	132.0	773,600
34	78.7	131.6	773,600
36	77.8	131.1	773,600
38	76.8	130.5	750,200
40	75.8	130.0	712,000
45	73.4	128.4	580,600
50	71.0	126.6	478,000
55	68.5	124.5	395,600
60	66.0	122.2	327,700
65	63.4	119.6	270,800
70	60.7	116.7	222,300
75	58.0	113.5	180,400
80	55.2	109.9	143,700
85	52.3	106.0	111,200
90	49.2	101.5	82,100
95	46.0	96.6	55,800
100	42.5	91.1	31,700

144.4 ft

ft	o	ft	lb
24	84.3	153.4	773,600
26	83.5	153.1	773,600
28	82.7	152.8	773,600
30	81.9	152.5	773,600
32	81.1	152.1	773,600
34	80.3	151.7	773,600
36	79.5	151.3	773,600
38	78.6	150.8	741,300
40	77.8	150.3	708,900
45	75.8	149.0	588,900
50	73.7	147.5	487,200
55	71.6	145.7	405,500
60	69.5	143.8	338,400
65	67.3	141.6	282,200
70	65.1	139.2	234,500
75	62.9	136.6	193,300
80	60.6	133.7	157,400
85	58.2	130.5	125,700
90	55.8	127.0	97,500
95	53.3	123.2	72,200
100	50.7	119.0	49,300
105	48.0	114.4	28,400

164.0 ft

ft	o	ft	lb
24	85.0	173.2	773,600
26	84.3	173.0	773,600
28	83.6	172.7	773,600
30	82.9	172.4	773,600
32	82.2	172.1	773,600
34	81.4	171.7	773,600
36	80.7	171.4	767,100
38	80.0	171.0	732,800
40	79.3	170.6	701,300
45	77.5	169.4	592,400
50	75.7	168.0	491,100
55	73.9	166.5	410,000
60	72.0	164.8	343,300
65	70.2	163.0	287,600
70	68.3	160.9	240,300
75	66.4	158.6	199,600
80	64.4	156.2	164,200
85	62.5	153.5	133,000
90	60.4	150.6	105,300
95	58.4	147.4	80,600
100	56.3	144.0	58,300
105	54.1	140.3	38,000
110	51.8	136.3	19,500

MLC650 S-3

ASME B30.5

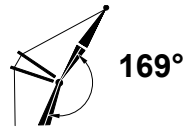
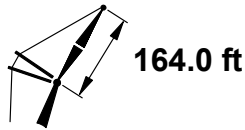
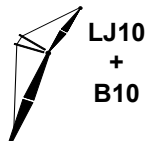

183.7 ft			
ft	o	ft	lb
26	84.9	192.8	773,600
28	84.3	192.6	773,600
30	83.6	192.3	773,600
32	83.0	192.0	773,600
34	82.4	191.7	773,600
36	81.7	191.4	757,300
38	81.1	191.0	724,100
40	80.5	190.6	693,500
45	78.9	189.6	592,900
50	77.3	188.4	492,000
55	75.7	187.1	411,200
60	74.0	185.6	344,900
65	72.4	183.9	289,600
70	70.7	182.1	242,600
75	69.1	180.2	202,200
80	67.4	178.0	167,100
85	65.6	175.7	136,200
90	63.9	173.2	108,800
95	62.1	170.5	84,400
100	60.3	167.5	62,500
105	58.5	164.4	42,600
110	56.6	161.1	24,500

203.4 ft			
ft	o	ft	lb
28	84.8	212.4	773,600
30	84.3	212.1	773,600
32	83.7	211.9	773,600
34	83.1	211.6	773,600
36	82.5	211.3	745,500
38	82.0	211.0	713,500
40	81.4	210.7	684,100
45	80.0	209.7	592,500
50	78.5	208.6	491,900
55	77.1	207.4	411,300
60	75.6	206.1	345,200
65	74.2	204.6	290,100
70	72.7	203.0	243,300
75	71.2	201.3	203,100
80	69.7	199.4	168,100
85	68.2	197.3	137,500
90	66.6	195.1	110,300
95	65.1	192.7	86,100
100	63.5	190.1	64,400
105	61.9	187.4	44,700
110	60.2	184.5	26,800

MLC650 S-3

ASME B30.5

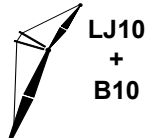

881,800 lb

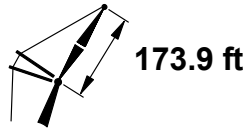

173.9 ft

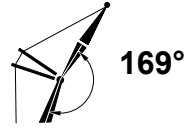

169°

124.7 ft

ft	o	ft	lb
22	84.3	133.8	773,600
24	83.4	133.5	773,600
26	82.4	133.2	773,600
28	81.5	132.8	773,600
30	80.6	132.4	773,600
32	79.6	132.0	773,600
34	78.7	131.6	773,600
36	77.8	131.1	773,600
38	76.8	130.5	749,800
40	75.8	130.0	692,800
45	73.4	128.4	562,000
50	71.0	126.6	459,900
55	68.5	124.5	377,800
60	66.0	122.2	310,300
65	63.4	119.6	253,700
70	60.7	116.7	205,400
75	58.0	113.5	163,700
80	55.2	109.9	127,100
85	52.3	106.0	94,800
90	49.2	101.5	65,900
95	46.0	96.6	39,700

144.4 ft

ft	o	ft	lb
24	84.3	153.4	773,600
26	83.5	153.1	773,600
28	82.7	152.8	773,600
30	81.9	152.5	773,600
32	81.1	152.1	773,600
34	80.3	151.7	773,600
36	79.5	151.3	773,600
38	78.6	150.8	741,300
40	77.8	150.3	701,300
45	75.8	149.0	571,500
50	73.7	147.5	470,200
55	71.6	145.7	388,900
60	69.5	143.8	322,100
65	67.3	141.6	266,200
70	65.1	139.2	218,700
75	62.9	136.6	177,700
80	60.6	133.7	142,000
85	58.2	130.5	110,500
90	55.8	127.0	82,400
95	53.3	123.2	57,300
100	50.7	119.0	34,500

164.0 ft

ft	o	ft	lb
24	85.0	173.2	773,600
26	84.3	173.0	773,600
28	83.6	172.7	773,600
30	82.9	172.4	773,600
32	82.2	172.1	773,600
34	81.4	171.7	773,600
36	80.7	171.4	767,100
38	80.0	171.0	732,800
40	79.3	170.6	701,300
45	77.5	169.4	575,800
50	75.7	168.0	475,000
55	73.9	166.5	394,200
60	72.0	164.8	327,900
65	70.2	163.0	272,500
70	68.3	160.9	225,500
75	66.4	158.6	185,000
80	64.4	156.2	149,700
85	62.5	153.5	118,700
90	60.4	150.6	91,200
95	58.4	147.4	66,500
100	56.3	144.0	44,300
105	54.1	140.3	24,200

MLC650 S-3

ASME B30.5

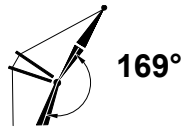
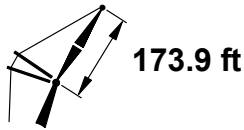
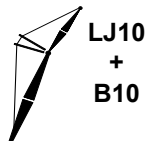

183.7 ft			
ft	o	ft	lb
26	84.9	192.8	773,600
28	84.3	192.6	773,600
30	83.6	192.3	773,600
32	83.0	192.0	773,600
34	82.4	191.7	773,600
36	81.7	191.4	757,300
38	81.1	191.0	724,100
40	80.5	190.6	693,500
45	78.9	189.6	577,000
50	77.3	188.4	476,600
55	75.7	187.1	396,200
60	74.0	185.6	330,200
65	72.4	183.9	275,200
70	70.7	182.1	228,400
75	69.1	180.2	188,200
80	67.4	178.0	153,300
85	65.6	175.7	122,600
90	63.9	173.2	95,400
95	62.1	170.5	71,100
100	60.3	167.5	49,200
105	58.5	164.4	29,500

203.4 ft			
ft	o	ft	lb
28	84.8	212.4	773,600
30	84.3	212.1	773,600
32	83.7	211.9	773,600
34	83.1	211.6	773,600
36	82.5	211.3	745,500
38	82.0	211.0	713,500
40	81.4	210.7	684,100
45	80.0	209.7	577,200
50	78.5	208.6	477,100
55	77.1	207.4	396,900
60	75.6	206.1	331,100
65	74.2	204.6	276,200
70	72.7	203.0	229,700
75	71.2	201.3	189,700
80	69.7	199.4	155,000
85	68.2	197.3	124,500
90	66.6	195.1	97,500
95	65.1	192.7	73,400
100	63.5	190.1	51,700
105	61.9	187.4	32,200

MLC650 S-3

ASME B30.5

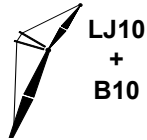

881,800 lb

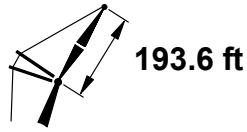

193.6 ft

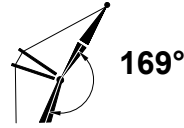

169°

124.7 ft

ft	o	ft	lb
22	84.3	133.8	773,600
24	83.4	133.5	773,600
26	82.4	133.2	773,600
28	81.5	132.8	773,600
30	80.6	132.4	773,600
32	79.6	132.0	773,600
34	78.7	131.6	773,600
36	77.8	131.1	773,600
38	76.8	130.5	721,600
40	75.8	130.0	658,900
45	73.4	128.4	529,300
50	71.0	126.6	428,100
55	68.5	124.5	346,800
60	66.0	122.2	279,800
65	63.4	119.6	223,700
70	60.7	116.7	175,900
75	58.0	113.5	134,600
80	55.2	109.9	98,400
85	52.3	106.0	66,400
90	49.2	101.5	37,800

144.4 ft

ft	o	ft	lb
24	84.3	153.4	773,600
26	83.5	153.1	773,600
28	82.7	152.8	773,600
30	81.9	152.5	773,600
32	81.1	152.1	773,600
34	80.3	151.7	773,600
36	79.5	151.3	773,600
38	78.6	150.8	731,900
40	77.8	150.3	669,600
45	75.8	149.0	540,900
50	73.7	147.5	440,500
55	71.6	145.7	360,000
60	69.5	143.8	293,800
65	67.3	141.6	238,500
70	65.1	139.2	191,400
75	62.9	136.6	150,800
80	60.6	133.7	115,400
85	58.2	130.5	84,200
90	55.8	127.0	56,500
95	53.3	123.2	31,600

164.0 ft

ft	o	ft	lb
24	85.0	173.2	773,600
26	84.3	173.0	773,600
28	83.6	172.7	773,600
30	82.9	172.4	773,600
32	82.2	172.1	773,600
34	81.4	171.7	773,600
36	80.7	171.4	767,100
38	80.0	171.0	732,800
40	79.3	170.6	674,900
45	77.5	169.4	546,900
50	75.7	168.0	447,100
55	73.9	166.5	367,000
60	72.0	164.8	301,400
65	70.2	163.0	246,500
70	68.3	160.9	199,900
75	66.4	158.6	159,700
80	64.4	156.2	124,800
85	62.5	153.5	94,100
90	60.4	150.6	66,900
95	58.4	147.4	42,500
100	56.3	144.0	20,500

MLC650 S-3

ASME B30.5

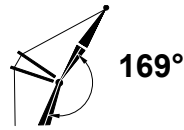
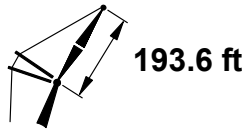
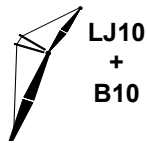

183.7 ft			
ft	o	ft	lb
26	84.9	192.8	773,600
28	84.3	192.6	773,600
30	83.6	192.3	773,600
32	83.0	192.0	773,600
34	82.4	191.7	773,600
36	81.7	191.4	757,300
38	81.1	191.0	724,100
40	80.5	190.6	676,900
45	78.9	189.6	549,300
50	77.3	188.4	449,900
55	75.7	187.1	370,300
60	74.0	185.6	305,000
65	72.4	183.9	250,400
70	70.7	182.1	204,100
75	69.1	180.2	164,300
80	67.4	178.0	129,700
85	65.6	175.7	99,300
90	63.9	173.2	72,400
95	62.1	170.5	48,400
100	60.3	167.5	26,700

203.4 ft			
ft	o	ft	lb
28	84.8	212.4	773,600
30	84.3	212.1	773,600
32	83.7	211.9	773,600
34	83.1	211.6	773,600
36	82.5	211.3	745,500
38	82.0	211.0	713,500
40	81.4	210.7	677,900
45	80.0	209.7	550,600
50	78.5	208.6	451,500
55	77.1	207.4	372,000
60	75.6	206.1	306,900
65	74.2	204.6	252,600
70	72.7	203.0	206,500
75	71.2	201.3	166,900
80	69.7	199.4	132,500
85	68.2	197.3	102,300
90	66.6	195.1	75,600
95	65.1	192.7	51,700
100	63.5	190.1	30,300

MLC650 S-3

ASME B30.5

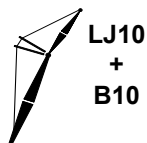

881,800 lb

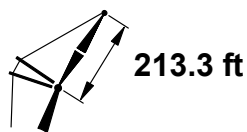

213.3 ft

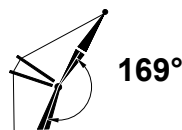

169°

124.7 ft

ft	o	ft	lb
22	84.3	133.8	773,600
24	83.4	133.5	773,600
26	82.4	133.2	773,600
28	81.5	132.8	773,600
30	80.6	132.4	773,600
32	79.6	132.0	773,600
34	78.7	131.6	773,600
36	77.8	131.1	756,000
38	76.8	130.5	685,900
40	75.8	130.0	623,800
45	73.4	128.4	495,300
50	71.0	126.6	395,100
55	68.5	124.5	314,500
60	66.0	122.2	248,200
65	63.4	119.6	192,700
70	60.7	116.7	145,300
75	58.0	113.5	104,400
80	55.2	109.9	68,600
85	52.3	106.0	36,900

144.4 ft

ft	o	ft	lb
24	84.3	153.4	773,600
26	83.5	153.1	773,600
28	82.7	152.8	773,600
30	81.9	152.5	773,600
32	81.1	152.1	773,600
34	80.3	151.7	773,600
36	79.5	151.3	768,000
38	78.6	150.8	698,400
40	77.8	150.3	636,700
45	75.8	149.0	509,200
50	73.7	147.5	409,800
55	71.6	145.7	330,000
60	69.5	143.8	264,500
65	67.3	141.6	209,700
70	65.1	139.2	163,100
75	62.9	136.6	122,900
80	60.6	133.7	87,900
85	58.2	130.5	57,100
90	55.8	127.0	29,600

164.0 ft

ft	o	ft	lb
24	85.0	173.2	773,600
26	84.3	173.0	773,600
28	83.6	172.7	773,600
30	82.9	172.4	773,600
32	82.2	172.1	773,600
34	81.4	171.7	773,600
36	80.7	171.4	767,100
38	80.0	171.0	705,100
40	79.3	170.6	643,700
45	77.5	169.4	516,900
50	75.7	168.0	418,100
55	73.9	166.5	338,800
60	72.0	164.8	273,800
65	70.2	163.0	219,500
70	68.3	160.9	173,300
75	66.4	158.6	133,600
80	64.4	156.2	99,100
85	62.5	153.5	68,700
90	60.4	150.6	41,700
95	58.4	147.4	17,600

REFERENCE ONLY

MLC650 S-3

ASME B30.5

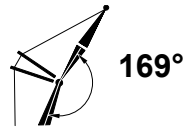
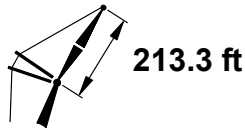
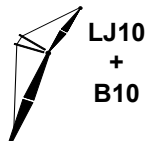

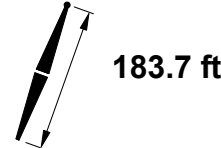
			
ft	°	ft	lb
26	84.9	192.8	773,600
28	84.3	192.6	773,600
30	83.6	192.3	773,600
32	83.0	192.0	773,600
34	82.4	191.7	773,600
36	81.7	191.4	757,300
38	81.1	191.0	708,200
40	80.5	190.6	647,100
45	78.9	189.6	520,700
50	77.3	188.4	422,300
55	75.7	187.1	343,500
60	74.0	185.6	278,800
65	72.4	183.9	224,800
70	70.7	182.1	179,000
75	69.1	180.2	139,600
80	67.4	178.0	105,400
85	65.6	175.7	75,300
90	63.9	173.2	48,700
95	62.1	170.5	24,900

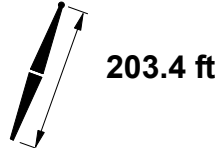
			
ft	°	ft	lb
28	84.8	212.4	773,600
30	84.3	212.1	773,600
32	83.7	211.9	773,600
34	83.1	211.6	773,600
36	82.5	211.3	745,500
38	82.0	211.0	710,200
40	81.4	210.7	649,100
45	80.0	209.7	523,100
50	78.5	208.6	424,900
55	77.1	207.4	346,300
60	75.6	206.1	281,900
65	74.2	204.6	228,100
70	72.7	203.0	182,500
75	71.2	201.3	143,300
80	69.7	199.4	109,200
85	68.2	197.3	79,400
90	66.6	195.1	52,900
95	65.1	192.7	29,400

REFERENCE ONLY!

MLC650 S-3

ASME B30.5

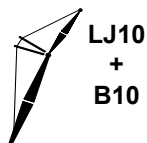

881,800 lb

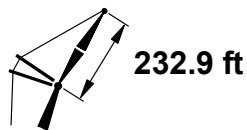

232.9 ft

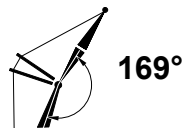

169°

124.7 ft

ft	o	ft	lb
22	84.3	133.8	773,600
24	83.4	133.5	773,600
26	82.4	133.2	773,600
28	81.5	132.8	773,600
30	80.6	132.4	773,600
32	79.6	132.0	773,600
34	78.7	131.6	773,600
36	77.8	131.1	722,300
38	76.8	130.5	652,800
40	75.8	130.0	591,300
45	73.4	128.4	464,000
50	71.0	126.6	364,700
55	68.5	124.5	284,800
60	66.0	122.2	219,200
65	63.4	119.6	164,200
70	60.7	116.7	117,300
75	58.0	113.5	76,800
80	55.2	109.9	41,300

144.4 ft

ft	o	ft	lb
24	84.3	153.4	773,600
26	83.5	153.1	773,600
28	82.7	152.8	773,600
30	81.9	152.5	773,600
32	81.1	152.1	773,600
34	80.3	151.7	773,600
36	79.5	151.3	736,400
38	78.6	150.8	667,400
40	77.8	150.3	606,300
45	75.8	149.0	480,000
50	73.7	147.5	381,600
55	71.6	145.7	302,600
60	69.5	143.8	237,700
65	67.3	141.6	183,400
70	65.1	139.2	137,300
75	62.9	136.6	97,500
80	60.6	133.7	62,800
85	58.2	130.5	32,300

164.0 ft

ft	o	ft	lb
24	85.0	173.2	773,600
26	84.3	173.0	773,600
28	83.6	172.7	773,600
30	82.9	172.4	773,600
32	82.2	172.1	773,600
34	81.4	171.7	773,600
36	80.7	171.4	744,400
38	80.0	171.0	675,800
40	79.3	170.6	614,900
45	77.5	169.4	489,400
50	75.7	168.0	391,500
55	73.9	166.5	313,000
60	72.0	164.8	248,600
65	70.2	163.0	194,800
70	68.3	160.9	149,200
75	66.4	158.6	109,900
80	64.4	156.2	75,700
85	62.5	153.5	45,600
90	60.4	150.6	18,900

REFER TO

MLC650 S-3

ASME B30.5

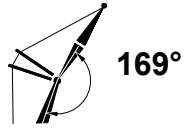
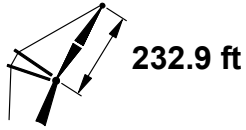
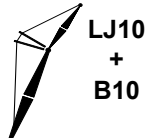

<p>183.7 ft</p>			
ft	°	ft	lb
26	84.9	192.8	773,600
28	84.3	192.6	773,600
30	83.6	192.3	773,600
32	83.0	192.0	773,600
34	82.4	191.7	773,600
36	81.7	191.4	748,500
38	81.1	191.0	680,200
40	80.5	190.6	619,600
45	78.9	189.6	494,500
50	77.3	188.4	397,100
55	75.7	187.1	319,000
60	74.0	185.6	255,000
65	72.4	183.9	201,500
70	70.7	182.1	156,200
75	69.1	180.2	117,200
80	67.4	178.0	83,300
85	65.6	175.7	53,500
90	63.9	173.2	27,200

REFERENCE ONLY!

MLC650 S-3

ASME B30.5

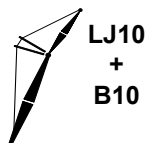

881,800 lb

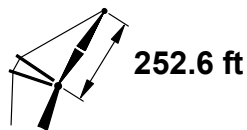

252.6 ft

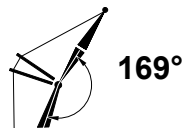

169°

124.7 ft

ft	o	ft	lb
22	84.3	133.8	773,600
24	83.4	133.5	773,600
26	82.4	133.2	773,600
28	81.5	132.8	773,600
30	80.6	132.4	773,600
32	79.6	132.0	773,600
34	78.7	131.6	759,700
36	77.8	131.1	681,700
38	76.8	130.5	613,000
40	75.8	130.0	552,100
45	73.4	128.4	426,300
50	71.0	126.6	328,100
55	68.5	124.5	249,200
60	66.0	122.2	184,300
65	63.4	119.6	129,900
70	60.7	116.7	83,600
75	58.0	113.5	43,600

144.4 ft

ft	o	ft	lb
24	84.3	153.4	773,600
26	83.5	153.1	773,600
28	82.7	152.8	773,600
30	81.9	152.5	773,600
32	81.1	152.1	773,600
34	80.3	151.7	773,600
36	79.5	151.3	698,200
38	78.6	150.8	630,100
40	77.8	150.3	569,600
45	75.8	149.0	444,800
50	73.7	147.5	347,500
55	71.6	145.7	269,500
60	69.5	143.8	205,400
65	67.3	141.6	151,700
70	65.1	139.2	106,100
75	62.9	136.6	66,900
80	60.6	133.7	32,700

164.0 ft

ft	o	ft	lb
24	85.0	173.2	773,600
26	84.3	173.0	773,600
28	83.6	172.7	773,600
30	82.9	172.4	773,600
32	82.2	172.1	773,600
34	81.4	171.7	773,600
36	80.7	171.4	708,100
38	80.0	171.0	640,300
40	79.3	170.6	580,200
45	77.5	169.4	456,100
50	75.7	168.0	359,400
55	73.9	166.5	281,900
60	72.0	164.8	218,300
65	70.2	163.0	165,100
70	68.3	160.9	120,000
75	66.4	158.6	81,200
80	64.4	156.2	47,400
85	62.5	153.5	17,700

REFER TO

MLC650 S-3

ASME B30.5

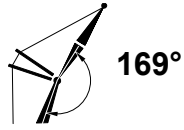
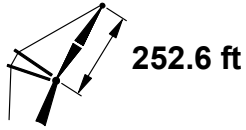
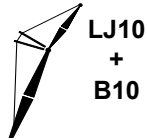

<p>183.7 ft</p>			
ft	°	ft	lb
26	84.9	192.8	773,600
28	84.3	192.6	773,600
30	83.6	192.3	773,600
32	83.0	192.0	773,600
34	82.4	191.7	773,600
36	81.7	191.4	713,700
38	81.1	191.0	646,200
40	80.5	190.6	586,300
45	78.9	189.6	462,700
50	77.3	188.4	366,500
55	75.7	187.1	289,400
60	74.0	185.6	226,100
65	72.4	183.9	173,300
70	70.7	182.1	128,600
75	69.1	180.2	90,100
80	67.4	178.0	56,600
85	65.6	175.7	27,200

REFERENCE ONLY!

MLC650 S-3

ASME B30.5

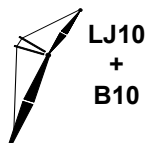

881,800 lb

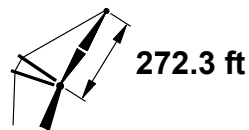

272.3 ft

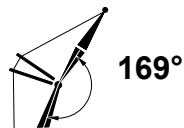

169°

124.7 ft

ft	o	ft	lb
22	84.3	133.8	773,600
24	83.4	133.5	773,600
26	82.4	133.2	773,600
28	81.5	132.8	773,600
30	80.6	132.4	773,600
32	79.6	132.0	773,600
34	78.7	131.6	722,300
36	77.8	131.1	645,100
38	76.8	130.5	577,200
40	75.8	130.0	517,000
45	73.4	128.4	392,500
50	71.0	126.6	295,400
55	68.5	124.5	217,400
60	66.0	122.2	153,200
65	63.4	119.6	99,500
70	60.7	116.7	53,700

144.4 ft

ft	o	ft	lb
24	84.3	153.4	773,600
26	83.5	153.1	773,600
28	82.7	152.8	773,600
30	81.9	152.5	773,600
32	81.1	152.1	773,600
34	80.3	151.7	740,500
36	79.5	151.3	663,900
38	78.6	150.8	596,500
40	77.8	150.3	536,700
45	75.8	149.0	413,300
50	73.7	147.5	317,100
55	71.6	145.7	239,900
60	69.5	143.8	176,600
65	67.3	141.6	123,600
70	65.1	139.2	78,600
75	62.9	136.6	39,800

164.0 ft

ft	o	ft	lb
24	85.0	173.2	773,600
26	84.3	173.0	773,600
28	83.6	172.7	773,600
30	82.9	172.4	773,600
32	82.2	172.1	773,600
34	81.4	171.7	751,700
36	80.7	171.4	675,400
38	80.0	171.0	608,400
40	79.3	170.6	549,000
45	77.5	169.4	426,300
50	75.7	168.0	330,700
55	73.9	166.5	254,100
60	72.0	164.8	191,300
65	70.2	163.0	138,800
70	68.3	160.9	94,200
75	66.4	158.6	55,900
80	64.4	156.2	22,500

REFER TO

MLC650 S-3

ASME B30.5

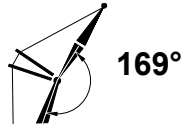
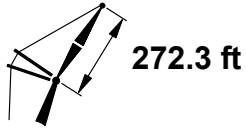
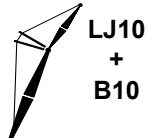

 183.7 ft			
ft	°	ft	lb
26	84.9	192.8	773,600
28	84.3	192.6	773,600
30	83.6	192.3	773,600
32	83.0	192.0	773,600
34	82.4	191.7	758,300
36	81.7	191.4	682,400
38	81.1	191.0	615,600
40	80.5	190.6	556,400
45	78.9	189.6	434,300
50	77.3	188.4	339,200
55	75.7	187.1	263,000
60	74.0	185.6	200,500
65	72.4	183.9	148,400
70	70.7	182.1	104,100
75	69.1	180.2	66,100
80	67.4	178.0	33,100

REFERENCE ONLY!

MLC650 S-3

ASME B30.5

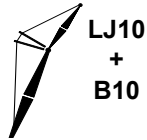

881,800 lb

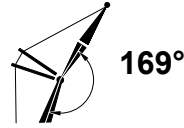
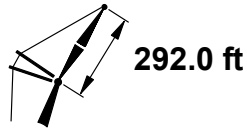

124.7 ft

ft	o	ft	lb
22	84.3	133.8	773,600
24	83.4	133.5	773,600
26	82.4	133.2	773,600
28	81.5	132.8	773,600
30	80.6	132.4	773,600
32	79.6	132.0	763,800
34	78.7	131.6	676,400
36	77.8	131.1	600,200
38	76.8	130.5	533,100
40	75.8	130.0	473,700
45	73.4	128.4	350,900
50	71.0	126.6	255,000
55	68.5	124.5	178,000
60	66.0	122.2	114,800
65	63.4	119.6	61,800

144.4 ft

ft	o	ft	lb
24	84.3	153.4	773,600
26	83.5	153.1	773,600
28	82.7	152.8	773,600
30	81.9	152.5	773,600
32	81.1	152.1	773,600
34	80.3	151.7	697,300
36	79.5	151.3	621,700
38	78.6	150.8	555,200
40	77.8	150.3	496,200
45	75.8	149.0	374,500
50	73.7	147.5	279,600
55	71.6	145.7	203,500
60	69.5	143.8	141,000
65	67.3	141.6	88,800
70	65.1	139.2	44,400

164.0 ft

ft	o	ft	lb
24	85.0	173.2	773,600
26	84.3	173.0	773,600
28	83.6	172.7	773,600
30	82.9	172.4	773,600
32	82.2	172.1	773,600
34	81.4	171.7	710,500
36	80.7	171.4	635,300
38	80.0	171.0	569,200
40	79.3	170.6	510,600
45	77.5	169.4	389,600
50	75.7	168.0	295,400
55	73.9	166.5	219,800
60	72.0	164.8	157,900
65	70.2	163.0	106,100
70	68.3	160.9	62,200
75	66.4	158.6	24,400

REFER TO THE MANITOWOC WEBSITE FOR THE COMPLETE LIFTING CAPACITY CHART.

MLC650 S-3

ASME B30.5

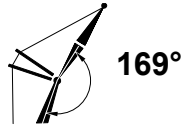
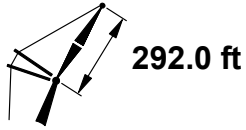
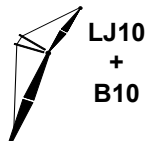

<p>183.7 ft</p>			
ft	°	ft	lb
26	84.9	192.8	773,600
28	84.3	192.6	773,600
30	83.6	192.3	773,600
32	83.0	192.0	773,600
34	82.4	191.7	718,800
36	81.7	191.4	643,900
38	81.1	191.0	578,100
40	80.5	190.6	519,800
45	78.9	189.6	399,400
50	77.3	188.4	305,600
55	75.7	187.1	230,500
60	74.0	185.6	168,900
65	72.4	183.9	117,500
70	70.7	182.1	73,900
75	69.1	180.2	36,400

REFERENCE ONLY!

MLC650 S-3

ASME B30.5

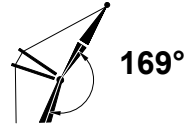
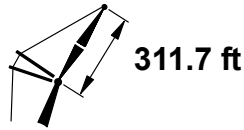
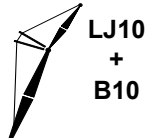

124.7 ft

ft	o	ft	lb
22	84.3	133.8	773,600
24	83.4	133.5	773,600
26	82.4	133.2	773,600
28	81.5	132.8	773,600
30	80.6	132.4	773,600
32	79.6	132.0	723,400
34	78.7	131.6	636,900
36	77.8	131.1	561,600
38	76.8	130.5	495,300
40	75.8	130.0	436,600
45	73.4	128.4	315,200
50	71.0	126.6	220,400
55	68.5	124.5	144,400
60	66.0	122.2	81,900
65	63.4	119.6	29,500

144.4 ft

ft	o	ft	lb
24	84.3	153.4	773,600
26	83.5	153.1	773,600
28	82.7	152.8	773,600
30	81.9	152.5	773,600
32	81.1	152.1	746,000
34	80.3	151.7	660,300
36	79.5	151.3	585,500
38	78.6	150.8	519,800
40	77.8	150.3	461,600
45	75.8	149.0	341,300
50	73.7	147.5	247,500
55	71.6	145.7	172,300
60	69.5	143.8	110,600
65	67.3	141.6	59,000

164.0 ft

ft	o	ft	lb
24	85.0	173.2	773,600
26	84.3	173.0	773,600
28	83.6	172.7	773,600
30	82.9	172.4	773,600
32	82.2	172.1	760,600
34	81.4	171.7	675,300
36	80.7	171.4	601,000
38	80.0	171.0	535,700
40	79.3	170.6	477,800
45	77.5	169.4	358,300
50	75.7	168.0	265,200
55	73.9	166.5	190,600
60	72.0	164.8	129,400
65	70.2	163.0	78,300
70	68.3	160.9	34,900

REFERENCE

MLC650 S-3

ASME B30.5

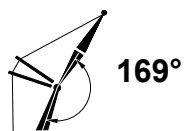
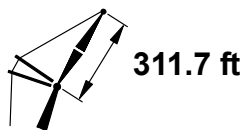
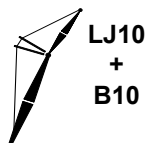

 183.7 ft			
ft	°	ft	lb
26	84.9	192.8	773,600
28	84.3	192.6	773,600
30	83.6	192.3	773,600
32	83.0	192.0	769,600
34	82.4	191.7	685,000
36	81.7	191.4	611,000
38	81.1	191.0	546,000
40	80.5	190.6	488,400
45	78.9	189.6	369,500
50	77.3	188.4	276,900
55	75.7	187.1	202,700
60	74.0	185.6	141,900
65	72.4	183.9	91,200
70	70.7	182.1	48,100

REFERENCE ONLY!

MLC650 S-3

ASME B30.5

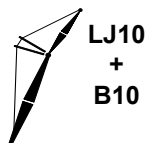

881,800 lb

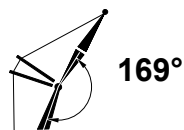
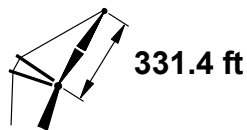

124.7 ft

ft	o	ft	lb
22	84.3	133.8	773,600
24	83.4	133.5	773,600
26	82.4	133.2	773,600
28	81.5	132.8	773,600
30	80.6	132.4	772,500
32	79.6	132.0	673,700
34	78.7	131.6	588,500
36	77.8	131.1	514,200
38	76.8	130.5	448,900
40	75.8	130.0	390,900
45	73.4	128.4	271,300
50	71.0	126.6	177,900
55	68.5	124.5	102,900
60	66.0	122.2	41,400

144.4 ft

ft	o	ft	lb
24	84.3	153.4	773,600
26	83.5	153.1	773,600
28	82.7	152.8	773,600
30	81.9	152.5	773,600
32	81.1	152.1	699,200
34	80.3	151.7	614,700
36	79.5	151.3	541,000
38	78.6	150.8	476,300
40	77.8	150.3	418,900
45	75.8	149.0	300,400
50	73.7	147.5	208,000
55	71.6	145.7	133,900
60	69.5	143.8	73,200
65	67.3	141.6	22,300

164.0 ft

ft	o	ft	lb
24	85.0	173.2	773,600
26	84.3	173.0	773,600
28	83.6	172.7	773,600
30	82.9	172.4	773,600
32	82.2	172.1	715,900
34	81.4	171.7	631,900
36	80.7	171.4	558,800
38	80.0	171.0	494,400
40	79.3	170.6	437,400
45	77.5	169.4	319,700
50	75.7	168.0	228,000
55	73.9	166.5	154,600
60	72.0	164.8	94,300
65	70.2	163.0	44,000

REFER TO

MLC650 S-3

ASME B30.5

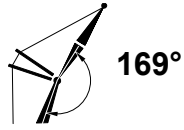
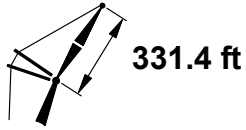
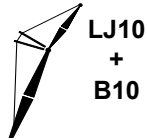

 183.7 ft			
ft	°	ft	lb
26	84.9	192.8	773,600
28	84.3	192.6	773,600
30	83.6	192.3	773,600
32	83.0	192.0	727,000
34	82.4	191.7	643,400
36	81.7	191.4	570,500
38	81.1	191.0	506,500
40	80.5	190.6	449,800
45	78.9	189.6	332,700
50	77.3	188.4	241,600
55	75.7	187.1	168,500
60	74.0	185.6	108,700
65	72.4	183.9	58,700

REFERENCE ONLY!