

Liftcrane Jib Capacities

Jib No. 117 on
Boom No. B10:290
73,000 lb Crane Counterweight
23,100 lb Carbody Counterweight
Crawler Machine on a Barge
0 Degree thru 3 Degree Static Machine List
No Travel - 360 Degree Rating

MLC90A-1 SERIES 2



LIFTING CAPACITIES: Chart supplements Boom Capacity chart No. 9760-A. Lifting capacities are for a crawler machine when operating on a barge. Machine shall be positively secured to prevent shifting. Lifting capacities for various boom lengths, jib lengths, and jib operating radii are for freely suspended loads and may be based on percent of static tipping or strength of structural components. Capacities must be reduced by applicable deducts.

Weight of all load blocks, hooks, weight ball, slings, hoist lines, etc., beneath boom and jib point sheaves is considered part of load. Boom and jib are not to be lowered beyond radii where combined weights are greater than rated capacity. Where no capacity is shown, operation is not intended or approved.

OPERATING CONDITIONS: Machine to operate on a firm and uniformly supporting surface with machine list not to exceed degrees noted. Refer to Boom Rigging No. 80121887, Jib Rigging No. 84054323, Wire Rope Specifications chart No. 9756-A, Counterweight Arrangements chart No. 9745-A, and Wind Conditions chart No. 9755-A. Crane operator judgment must be used to allow for dynamic load effects of swinging, hoisting or lowering, wind conditions, as well as adverse operating conditions and physical machine depreciation. Refer to the Operator Manual for operating guidelines.



OPERATING RADIUS: Operating radius is horizontal distance from axis of rotation at barge deck to center of vertical hoist line or load block.



BOOM ANGLE: Boom angle in degrees ($^{\circ}$) is angle between horizontal and centerline of boom butt and inserts, and is an indication of operating radius. In all cases, operating radius shall govern capacity.



JIB POINT ELEVATION: Jib point elevation is vertical distance from barge deck to centerline of jib point shaft.

MACHINE EQUIPMENT: Machine equipped with 21 ft 3 in. crawlers, 35 in. treads, 14 ft 5 in. gantry, 8 part boom hoist reeving, two 32 mm boom pendants, 73,000 lb crane counterweight, and 23,100 lb carbody counterweight.

Refer to Tables 1 and 2 for raising ability with the maximum weight of all load blocks, hooks, weight ball, slings, and hoist lines beneath boom and jib point sheaves. For block weights shown with # or (a), load blocks, hooks, weight ball, and slings must remain on barge deck until combined weights are within rated capacity of chart. For block weights shown with (a), optional 3rd sheave in boom top wire rope guide and 2nd anti-two-block on boom top must be removed, and boom must be rigged with a maximum of 2 load hoist lead lines. Raising is not permitted in shaded areas of table.

Caution: Combined weight beneath boom and jib point sheaves must not exceed block weight shown. Total weight beneath jib point must not exceed 700 lb.

Table 1

| Over End or Side of Crawlers | | | | | | | | |
|------------------------------|-------------------|---------|---------|---------|-----------------------|---------|---------|---------|
| Boom Length (ft) | Jib No. 117 | | | | | | | |
| | 30.0 ft | | 40.0 ft | | 50.0 ft | | 60.0 ft | |
| | 0° | 1° - 3° | 0° | 1° - 3° | 0° | 1° - 3° | 0° | 1° - 3° |
| | Block Weight (lb) | | | | | | | |
| 62.3 - 141.1 | 3,800 | 3,800 | 3,800 | 3,800 | 3,800 | 3,800 | 3,800 | 3,800 |
| 150.9 | 3,800 | 3,800 | 2,650 | 2,650 | 2,650 | 2,650 | 2,650 | 2,650 |
| 160.8 | 2,650 | 2,650 | 700 | 700 | 700 | 700 | 700 | 700 |
| 170.6 | 700 | 700 | 700 | 700 | 700 | 700 | # | # |
| 180.4 | 700 | a | 700 | a | a | a | a | |
| 190.3 | a | a | a | a | Raising Not Permitted | | | |

Table 2

| Over End of Blocked Crawlers | | | | | | | | |
|------------------------------|-------------------|---------|---------|---------|---------|---------|---------|---------|
| Boom Length (ft) | Jib No. 117 | | | | | | | |
| | 30.0 ft | | 40.0 ft | | 50.0 ft | | 60.0 ft | |
| | 0° | 1° - 3° | 0° | 1° - 3° | 0° | 1° - 3° | 0° | 1° - 3° |
| | Block Weight (lb) | | | | | | | |
| 62.3 - 141.1 | 3,800 | 3,800 | 3,800 | 3,800 | 3,800 | 3,800 | 3,800 | 3,800 |
| 150.9 | 3,800 | 3,800 | 2,650 | 2,650 | 2,650 | 2,650 | 2,650 | 2,650 |
| 160.8 | 2,650 | 2,650 | 700 | 700 | 700 | 700 | 700 | 700 |
| 170.6 | 700 | 700 | 700 | 700 | 700 | 700 | # | # |
| 180.4 | 700 | a | 700 | a | a | a | a | |
| 190.3 | a | a | a | a | a | a | a | |

Warning: Crane must remain in-line with crawlers when raising over end of blocked crawlers until operating radius is within 360 degree chart. Crane tipping or structural damage can occur.

Explanation of Symbols

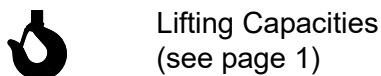
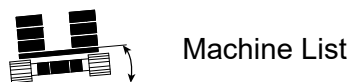
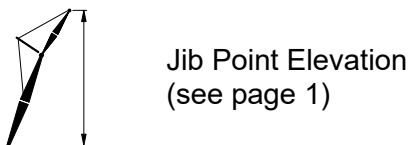
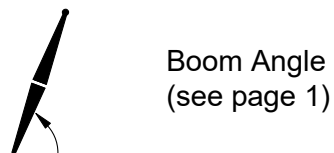
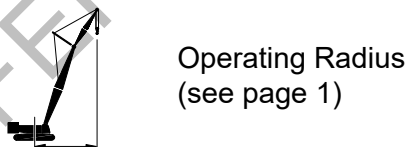
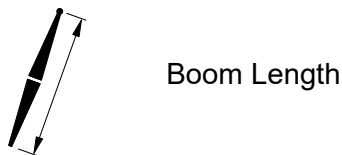
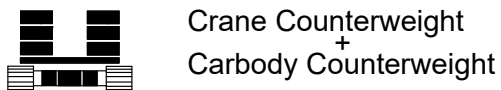
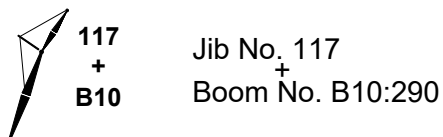

MLC90A-1 S-2

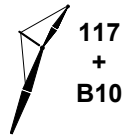

73,000 lb
+
23,100 lb

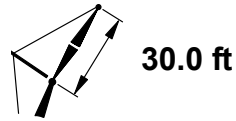
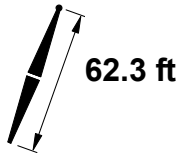

| | | 10° | | | | | | 30° | | | | | | | |
|----|------|------|--------|--------|--------|--------|------|------|--------|--------|--------|--------|----|----|--|
| | | | | | | | | | | | | | | | |
| | | | | | | | | | | | | | | | |
| | | | | 0° | 1° | 2° | 3° | | | 0° | 1° | 2° | 3° | | |
| ft | ° | ft | lb | lb | lb | lb | ° | ft | lb | lb | lb | lb | ft | | |
| 26 | 80.7 | 97.6 | 27,600 | | | | | | | | | | | 26 | |
| 28 | 79.4 | 97.2 | 27,600 | 27,600 | | | | | | | | | | 28 | |
| 30 | 78.2 | 96.6 | 27,600 | 27,600 | | | | | | | | | | 30 | |
| 32 | 76.9 | 96.0 | 27,600 | 27,600 | 25,100 | | | | | | | | | 32 | |
| 34 | 75.6 | 95.4 | 27,600 | 27,600 | 25,000 | 22,700 | | | | | | | | 34 | |
| 36 | 74.3 | 94.7 | 27,600 | 27,600 | 24,700 | 22,400 | 80.8 | 92.9 | 20,900 | | | | | 36 | |
| 38 | 73.0 | 94.0 | 27,600 | 27,400 | 24,600 | 22,300 | 79.4 | 92.2 | 20,400 | 20,000 | | | | 38 | |
| 40 | 71.7 | 93.2 | 27,600 | 27,200 | 24,400 | 22,200 | 78.1 | 91.5 | 19,900 | 19,600 | 19,200 | | | 40 | |
| 42 | 70.3 | 92.3 | 27,600 | 27,100 | 24,300 | 22,100 | 76.7 | 90.6 | 19,400 | 19,100 | 18,800 | 18,500 | | 42 | |
| 44 | 69.0 | 91.4 | 27,600 | 27,000 | 24,200 | 21,900 | 75.3 | 89.8 | 19,000 | 18,700 | 18,400 | 18,100 | | 44 | |
| 46 | 67.6 | 90.4 | 27,600 | 26,800 | 24,100 | 21,800 | 74.0 | 88.8 | 18,600 | 18,300 | 18,000 | 17,700 | | 46 | |
| 48 | 66.2 | 89.4 | 27,600 | 26,700 | 24,000 | 21,800 | 72.5 | 87.8 | 18,200 | 17,900 | 17,600 | 17,400 | | 48 | |
| 50 | 64.8 | 88.3 | 27,600 | 26,500 | 23,900 | 21,700 | 71.1 | 86.8 | 17,800 | 17,500 | 17,300 | 17,100 | | 50 | |
| 55 | 61.2 | 85.3 | 27,600 | 26,300 | 23,900 | 21,500 | 69.7 | 85.7 | 17,400 | 17,200 | 17,000 | 16,700 | | 55 | |
| 60 | 57.5 | 81.9 | 27,200 | 26,000 | 23,400 | 21,300 | 66.0 | 82.6 | 16,600 | 16,400 | 16,200 | 16,000 | | 60 | |
| | | | | | | | 62.1 | 79.0 | 15,900 | 15,700 | 15,500 | 15,400 | | 60 | |
| 65 | 53.6 | 77.9 | 25,500 | 25,100 | 23,300 | 21,200 | 58.0 | 74.9 | 15,200 | 15,100 | 15,000 | 14,800 | | 65 | |
| 70 | 49.4 | 73.3 | 23,900 | 23,300 | 22,500 | 21,200 | 53.6 | 70.1 | 14,700 | 14,600 | 14,500 | 14,400 | | 70 | |
| 75 | 44.9 | 68.0 | 22,000 | 21,300 | 20,700 | 20,100 | 48.9 | 64.4 | 14,200 | 14,100 | 14,000 | 14,000 | | 75 | |
| 80 | 40.0 | 61.7 | 20,200 | 19,600 | 19,100 | 18,500 | 43.6 | 57.7 | 13,800 | 13,800 | 13,700 | 13,700 | | 80 | |
| 85 | 34.4 | 54.1 | 18,500 | 18,100 | 17,600 | 17,200 | 37.4 | 49.3 | 13,500 | 13,500 | 13,500 | 13,400 | | 85 | |
| 90 | 27.6 | 44.3 | 17,100 | 16,700 | 16,400 | 16,000 | | | | | | | | 90 | |

MLC90A-1 S-2

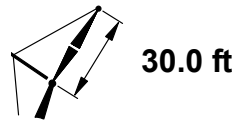
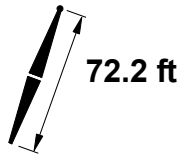
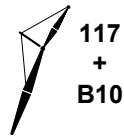

| | 10° | | | | | | 30° | | | | | | | | | |
|-----|------|-------|--------|----------|----------|----------|----------|-------|--------|--------|----------|----------|--|----------|----------|-----|
| | | | | | | | | | | | | | | | | |
| | ft | ° | ft | 0° lb | 1° lb | 2° lb | 3° lb | ft | ° | ft | 0° lb | 1° lb | | 2° lb | 3° lb | ft |
| 28 | 80.5 | 107.3 | 27,600 | | | | | | | | | | | | | 28 |
| 30 | 79.3 | 106.8 | 27,600 | 27,600 | | | | | | | | | | | | 30 |
| 32 | 78.2 | 106.2 | 27,600 | 27,600 | 25,100 | | | | | | | | | | | 32 |
| 34 | 77.0 | 105.7 | 27,600 | 27,600 | 24,900 | 22,500 | | | | | | | | | | 34 |
| 36 | 75.9 | 105.1 | 27,600 | 27,600 | 24,800 | 22,500 | 80.5 | 102.5 | 20,800 | | | | | | | 36 |
| 38 | 74.7 | 104.4 | 27,600 | 27,600 | 24,700 | 22,300 | 79.3 | 101.8 | 20,300 | 20,000 | | | | | | 38 |
| 40 | 73.5 | 103.7 | 27,600 | 27,500 | 24,600 | 22,300 | 78.1 | 101.1 | 19,900 | 19,500 | 19,200 | | | | | 40 |
| 42 | 72.3 | 102.9 | 27,600 | 27,300 | 24,500 | 22,100 | 76.9 | 100.3 | 19,500 | 19,100 | 18,800 | 18,300 | | | | 42 |
| 44 | 71.1 | 102.1 | 27,600 | 27,200 | 24,300 | 22,100 | 75.6 | 99.5 | 19,100 | 18,700 | 18,400 | 18,200 | | | | 44 |
| 46 | 69.9 | 101.3 | 27,600 | 27,000 | 24,200 | 22,000 | 74.4 | 98.6 | 18,700 | 18,400 | 18,100 | 17,800 | | | | 46 |
| 48 | 68.7 | 100.4 | 27,600 | 26,900 | 24,100 | 21,900 | 73.1 | 97.7 | 18,300 | 18,000 | 17,800 | 17,500 | | | | 48 |
| 50 | 67.5 | 99.4 | 27,600 | 26,800 | 24,000 | 21,800 | 71.9 | 96.7 | 18,000 | 17,700 | 17,400 | 17,200 | | | | 50 |
| 55 | 64.3 | 96.8 | 27,600 | 26,500 | 23,800 | 21,700 | 68.6 | 94.0 | 17,200 | 16,900 | 16,700 | 16,500 | | | | 55 |
| 60 | 61.1 | 93.8 | 27,600 | 26,300 | 23,600 | 21,500 | 65.3 | 90.9 | 16,400 | 16,200 | 16,100 | 15,900 | | | | 60 |
| 65 | 57.7 | 90.4 | 26,400 | 25,300 | 23,500 | 21,300 | 61.8 | 87.4 | 15,800 | 15,600 | 15,500 | 15,300 | | | | 65 |
| 70 | 54.2 | 86.5 | 23,900 | 23,000 | 22,200 | 21,300 | 58.2 | 83.4 | 15,200 | 15,100 | 15,000 | 14,900 | | | | 70 |
| 75 | 50.5 | 82.2 | 21,800 | 21,000 | 20,300 | 19,600 | 54.3 | 78.8 | 14,700 | 14,600 | 14,500 | 14,400 | | | | 75 |
| 80 | 46.6 | 77.2 | 20,000 | 19,300 | 18,700 | 18,100 | 50.2 | 73.5 | 14,300 | 14,200 | 14,100 | 14,100 | | | | 80 |
| 85 | 42.3 | 71.4 | 18,400 | 17,800 | 17,300 | 16,800 | 45.7 | 67.4 | 13,900 | 13,900 | 13,800 | 13,800 | | | | 85 |
| 90 | 37.6 | 64.6 | 16,900 | 16,500 | 16,000 | 15,600 | 40.6 | 60.1 | 13,600 | 13,600 | 13,600 | 13,500 | | | | 90 |
| 95 | 32.3 | 56.4 | 15,700 | 15,300 | 14,900 | 14,500 | 34.7 | 51.1 | 13,400 | 13,400 | 13,400 | 13,400 | | | | 95 |
| 100 | 25.8 | 45.8 | 14,500 | 14,200 | 13,900 | 13,600 | | | | | | | | | | 100 |

MLC90A-1 S-2



73,000 lb
+
23,100 lb

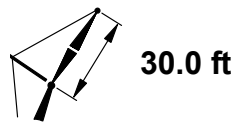
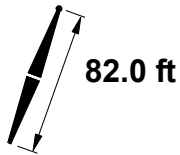

| | 10° | | | | | | | 30° | | | | | | |
|-----|------|-------|--------|--------|--------|--------|------|-------|--------|--------|--------|--------|----|-----|
| | | | | | | | | | | | | | | |
| | | | | | | | | | | | | | | |
| | | | | | | | | | | | | | | |
| | ft | ° | ft | lb | lb | lb | lb | ° | ft | lb | lb | lb | lb | ft |
| 30 | 80.3 | 116.9 | 27,600 | | | | | | | | | | | 30 |
| 32 | 79.2 | 116.4 | 27,600 | 27,600 | | | | | | | | | | 32 |
| 34 | 78.2 | 115.9 | 27,600 | 27,600 | 24,900 | | | | | | | | | 34 |
| 36 | 77.1 | 115.3 | 27,600 | 27,600 | 24,900 | 22,500 | | | | | | | | 36 |
| 38 | 76.1 | 114.7 | 27,600 | 27,600 | 24,700 | 22,400 | 80.3 | 112.1 | 20,700 | | | | | 38 |
| 40 | 75.0 | 114.1 | 27,600 | 27,600 | 24,600 | 22,300 | 79.2 | 111.4 | 20,300 | 19,900 | | | | 40 |
| 42 | 73.9 | 113.4 | 27,600 | 27,400 | 24,500 | 22,200 | 78.1 | 110.7 | 19,900 | 19,500 | 19,200 | | | 42 |
| 44 | 72.9 | 112.7 | 27,600 | 27,300 | 24,400 | 22,100 | 77.0 | 110.0 | 19,500 | 19,200 | 18,800 | 17,700 | | 44 |
| 46 | 71.8 | 111.9 | 27,600 | 27,200 | 24,300 | 22,000 | 75.9 | 109.2 | 19,100 | 18,800 | 18,500 | 17,700 | | 46 |
| 48 | 70.7 | 111.1 | 27,600 | 27,100 | 24,300 | 22,000 | 74.8 | 108.4 | 18,800 | 18,500 | 18,200 | 17,700 | | 48 |
| 50 | 69.6 | 110.3 | 27,600 | 26,900 | 24,200 | 21,900 | 73.6 | 107.5 | 18,400 | 18,100 | 17,900 | 17,600 | | 50 |
| 55 | 66.8 | 107.9 | 27,600 | 26,700 | 24,000 | 21,800 | 70.8 | 105.1 | 17,600 | 17,400 | 17,200 | 16,900 | | 55 |
| 60 | 63.9 | 105.3 | 27,600 | 26,500 | 23,800 | 21,600 | 67.8 | 102.4 | 16,900 | 16,700 | 16,500 | 16,300 | | 60 |
| 65 | 60.9 | 102.3 | 26,100 | 24,900 | 23,600 | 21,500 | 64.7 | 99.3 | 16,300 | 16,100 | 16,000 | 15,800 | | 65 |
| 70 | 57.9 | 98.9 | 23,600 | 22,700 | 21,700 | 20,800 | 61.6 | 95.8 | 15,800 | 15,600 | 15,400 | 15,300 | | 70 |
| 75 | 54.7 | 95.1 | 21,500 | 20,700 | 19,900 | 19,100 | 58.3 | 91.9 | 15,200 | 15,100 | 15,000 | 14,900 | | 75 |
| 80 | 51.4 | 90.9 | 19,700 | 19,000 | 18,300 | 17,600 | 54.8 | 87.5 | 14,800 | 14,700 | 14,600 | 14,500 | | 80 |
| 85 | 47.9 | 86.1 | 18,100 | 17,500 | 16,900 | 16,300 | 51.2 | 82.5 | 14,400 | 14,300 | 14,200 | 14,100 | | 85 |
| 90 | 44.1 | 80.7 | 16,700 | 16,100 | 15,600 | 15,100 | 47.2 | 76.8 | 14,000 | 14,000 | 13,900 | 13,800 | | 90 |
| 95 | 40.1 | 74.5 | 15,400 | 15,000 | 14,500 | 14,100 | 42.9 | 70.2 | 13,800 | 13,700 | 13,700 | 13,600 | | 95 |
| 100 | 35.6 | 67.2 | 14,300 | 13,900 | 13,500 | 13,100 | 38.1 | 62.4 | 13,500 | 13,500 | 13,500 | 13,300 | | 100 |
| 105 | 30.5 | 58.5 | 13,300 | 13,000 | 12,600 | 12,300 | 32.4 | 52.7 | 13,300 | 13,000 | 12,700 | 12,400 | | 105 |
| 110 | 24.2 | 47.3 | 12,400 | 12,100 | 11,800 | 11,500 | | | | | | | | 110 |

MLC90A-1 S-2

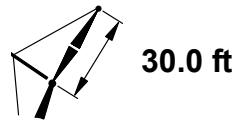
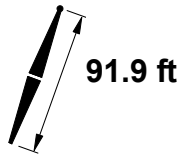
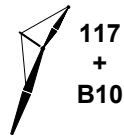

| | 10° | | | | | | 30° | | | | | | | | |
|-----|------|-------|--------|-----------------------|--------|--------|------|-------|--------|--------|-----------------------|--------|----|-----|----|
| | ft | ° | ft | 73,000 lb + 23,100 lb | | | | ft | ° | ft | 73,000 lb + 23,100 lb | | | | |
| | | | | 0° | 1° | 2° | 3° | | | | 0° | 1° | | 2° | 3° |
| lb | lb | lb | lb | lb | lb | lb | lb | lb | lb | lb | lb | lb | lb | | |
| 32 | 80.1 | 126.5 | 27,600 | | | | | | | | | | | 32 | |
| 34 | 79.2 | 126.0 | 27,600 | 27,600 | | | | | | | | | | 34 | |
| 36 | 78.2 | 125.5 | 27,600 | 27,600 | 24,800 | | | | | | | | | 36 | |
| 38 | 77.2 | 125.0 | 27,600 | 27,600 | 24,700 | 22,300 | | | | | | | | 38 | |
| 40 | 76.3 | 124.4 | 27,600 | 27,600 | 24,600 | 22,300 | 80.1 | 121.7 | 20,600 | | | | | 40 | |
| 42 | 75.3 | 123.8 | 27,600 | 27,500 | 24,600 | 22,200 | 79.1 | 121.1 | 20,200 | 19,900 | | | | 42 | |
| 44 | 74.3 | 123.1 | 27,600 | 27,500 | 24,500 | 22,100 | 78.1 | 120.4 | 19,900 | 19,500 | 19,200 | | | 44 | |
| 46 | 73.3 | 122.4 | 27,600 | 27,300 | 24,400 | 22,000 | 77.1 | 119.7 | 19,500 | 19,200 | 18,800 | 17,200 | | 46 | |
| 48 | 72.3 | 121.7 | 27,600 | 27,200 | 24,300 | 22,000 | 76.1 | 118.9 | 19,200 | 18,800 | 18,500 | 17,200 | | 48 | |
| 50 | 71.3 | 120.9 | 27,600 | 27,100 | 24,200 | 21,900 | 75.1 | 118.1 | 18,800 | 18,500 | 18,200 | 17,200 | | 50 | |
| 55 | 68.8 | 118.8 | 27,600 | 26,900 | 24,000 | 21,800 | 72.5 | 115.9 | 18,100 | 17,800 | 17,600 | 17,200 | | 55 | |
| 60 | 66.2 | 116.4 | 27,600 | 26,600 | 23,800 | 21,600 | 69.8 | 113.5 | 17,400 | 17,200 | 16,900 | 16,700 | | 60 | |
| 65 | 63.5 | 113.7 | 25,900 | 24,700 | 23,500 | 21,500 | 67.1 | 110.7 | 16,800 | 16,600 | 16,400 | 16,200 | | 65 | |
| 70 | 60.8 | 110.7 | 23,500 | 22,400 | 21,400 | 20,400 | 64.3 | 107.7 | 16,200 | 16,000 | 15,900 | 15,700 | | 70 | |
| 75 | 58.0 | 107.4 | 21,400 | 20,400 | 19,600 | 18,700 | 61.4 | 104.2 | 15,700 | 15,600 | 15,400 | 15,300 | | 75 | |
| 80 | 55.1 | 103.7 | 19,500 | 18,700 | 18,000 | 17,300 | 58.4 | 100.4 | 15,300 | 15,100 | 15,000 | 14,900 | | 80 | |
| 85 | 52.1 | 99.6 | 17,900 | 17,300 | 16,600 | 16,000 | 55.3 | 96.2 | 14,800 | 14,700 | 14,600 | 14,500 | | 85 | |
| 90 | 48.9 | 95.0 | 16,500 | 15,900 | 15,400 | 14,800 | 52.0 | 91.4 | 14,500 | 14,400 | 14,300 | 14,200 | | 90 | |
| 95 | 45.6 | 89.9 | 15,300 | 14,800 | 14,300 | 13,800 | 48.5 | 86.0 | 14,100 | 14,100 | 14,000 | 13,900 | | 95 | |
| 100 | 42.0 | 84.1 | 14,200 | 13,700 | 13,300 | 12,800 | 44.7 | 79.9 | 13,900 | 13,800 | 13,400 | 13,000 | | 100 | |
| 105 | 38.1 | 77.4 | 13,200 | 12,800 | 12,400 | 12,000 | 40.6 | 72.9 | 13,300 | 12,900 | 12,500 | 12,100 | | 105 | |
| 110 | 33.8 | 69.7 | 12,300 | 11,900 | 11,600 | 11,200 | 35.9 | 64.5 | 12,300 | 12,000 | 11,700 | 11,300 | | 110 | |
| 115 | 28.9 | 60.4 | 11,400 | 11,100 | 10,800 | 10,500 | 30.5 | 54.2 | 11,500 | 11,200 | 10,900 | 10,600 | | 115 | |
| 120 | 22.9 | 48.6 | 10,600 | 10,400 | 10,200 | 9,900 | | | | | | | | 120 | |

MLC90A-1 S-2

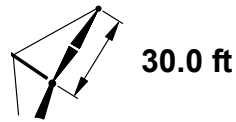
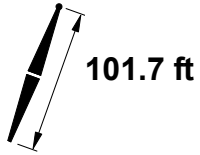
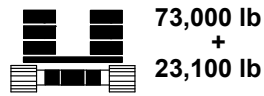
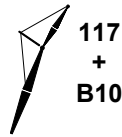

| | | 10° | | | | | | 30° | | | | | | |
|-----|------|-------|--------|--------|--------|--------|------|-------|--------|--------|--------|--------|--|-----|
| | | | | | | | | | | | | | | |
| | | | | | | | | | | | | | | |
| | | 0° | | | | 1° | | 0° | | | | 1° | | |
| | | 2° | | | | 3° | | 2° | | | | 3° | | |
| | | lb | | | | lb | | lb | | | | lb | | |
| | | ft | | ° | | ft | | ° | | ft | | ° | | |
| 32 | 80.9 | 136.6 | 27,600 | | | | | | | | | | | 32 |
| 34 | 80.0 | 136.1 | 27,600 | 27,600 | | | | | | | | | | 34 |
| 36 | 79.1 | 135.7 | 27,600 | 27,600 | | | | | | | | | | 36 |
| 38 | 78.2 | 135.2 | 27,600 | 27,600 | 24,700 | | | | | | | | | 38 |
| 40 | 77.3 | 134.6 | 27,600 | 27,600 | 24,600 | 22,200 | 80.9 | 131.9 | 20,900 | | | | | 40 |
| 42 | 76.4 | 134.1 | 27,600 | 27,600 | 24,600 | 22,200 | 80.0 | 131.3 | 20,500 | 20,200 | | | | 42 |
| 44 | 75.5 | 133.4 | 27,600 | 27,500 | 24,500 | 22,100 | 79.1 | 130.7 | 20,200 | 19,800 | | | | 44 |
| 46 | 74.6 | 132.8 | 27,600 | 27,400 | 24,400 | 22,100 | 78.1 | 130.0 | 19,800 | 19,500 | 19,200 | | | 46 |
| 48 | 73.7 | 132.1 | 27,600 | 27,300 | 24,300 | 22,000 | 77.2 | 129.3 | 19,500 | 19,200 | 18,900 | 16,900 | | 48 |
| 50 | 72.8 | 131.4 | 27,600 | 27,200 | 24,200 | 21,900 | 76.3 | 128.6 | 19,200 | 18,900 | 18,600 | 16,800 | | 50 |
| 55 | 70.4 | 129.5 | 27,600 | 27,000 | 24,100 | 21,800 | 73.9 | 126.6 | 18,500 | 18,200 | 17,900 | 16,800 | | 55 |
| 60 | 68.1 | 127.3 | 27,600 | 26,800 | 23,900 | 21,600 | 71.5 | 124.4 | 17,800 | 17,500 | 17,300 | 16,800 | | 60 |
| 65 | 65.7 | 124.9 | 25,700 | 24,300 | 23,000 | 21,500 | 69.0 | 121.9 | 17,200 | 17,000 | 16,800 | 16,500 | | 65 |
| 70 | 63.2 | 122.2 | 23,200 | 22,100 | 21,000 | 19,900 | 66.5 | 119.1 | 16,600 | 16,400 | 16,200 | 16,100 | | 70 |
| 75 | 60.7 | 119.2 | 21,100 | 20,100 | 19,200 | 18,300 | 63.9 | 116.1 | 16,100 | 16,000 | 15,800 | 15,600 | | 75 |
| 80 | 58.1 | 115.9 | 19,300 | 18,400 | 17,600 | 16,800 | 61.2 | 112.7 | 15,700 | 15,500 | 15,400 | 15,200 | | 80 |
| 85 | 55.4 | 112.3 | 17,700 | 16,900 | 16,200 | 15,500 | 58.5 | 108.9 | 15,300 | 15,100 | 15,000 | 14,900 | | 85 |
| 90 | 52.7 | 108.3 | 16,300 | 15,600 | 15,000 | 14,400 | 55.6 | 104.8 | 14,900 | 14,800 | 14,600 | 14,500 | | 90 |
| 95 | 49.8 | 103.8 | 15,000 | 14,500 | 13,900 | 13,400 | 52.6 | 100.2 | 14,500 | 14,400 | 14,100 | 13,600 | | 95 |
| 100 | 46.8 | 98.9 | 13,900 | 13,400 | 12,900 | 12,400 | 49.5 | 95.1 | 14,100 | 13,600 | 13,100 | 12,600 | | 100 |
| 105 | 43.5 | 93.4 | 12,900 | 12,500 | 12,000 | 11,600 | 46.1 | 89.3 | 13,100 | 12,600 | 12,200 | 11,800 | | 105 |
| 110 | 40.1 | 87.3 | 12,000 | 11,600 | 11,200 | 10,800 | 42.5 | 82.8 | 12,100 | 11,700 | 11,400 | 11,000 | | 110 |
| 115 | 36.4 | 80.2 | 11,200 | 10,800 | 10,500 | 10,100 | 38.5 | 75.3 | 11,300 | 10,900 | 10,600 | 10,300 | | 115 |
| 120 | 32.2 | 72.1 | 10,400 | 10,100 | 9,800 | 9,500 | 34.0 | 66.5 | 10,500 | 10,200 | 9,900 | 9,600 | | 120 |
| 125 | 27.5 | 62.3 | 9,700 | 9,400 | 9,200 | 8,900 | | | | | | | | 125 |
| 130 | 21.7 | 49.8 | 9,100 | 8,800 | 8,600 | 8,400 | | | | | | | | 130 |

MLC90A-1 S-2

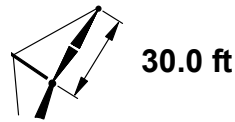
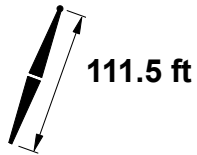
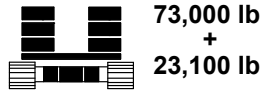
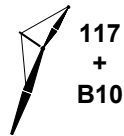

| | 10° | | | | | | | 30° | | | | | | | |
|-----|------|-------|--------|----------|----------|----------|----------|-------|--------|--------|----------|----------|----------|----------|-----|
| | | | | | | | | | | | | | | | |
| | ft | ° | ft | 0° lb | 1° lb | 2° lb | 3° lb | ft | ° | ft | 0° lb | 1° lb | 2° lb | 3° lb | ft |
| 34 | 80.7 | 146.2 | 27,600 | | | | | | | | | | | | 34 |
| 36 | 79.9 | 145.8 | 27,600 | 27,600 | | | | | | | | | | | 36 |
| 38 | 79.0 | 145.3 | 27,600 | 27,600 | | | | | | | | | | | 38 |
| 40 | 78.2 | 144.8 | 27,600 | 27,600 | 24,600 | | | | | | | | | | 40 |
| 42 | 77.4 | 144.3 | 27,600 | 27,500 | 24,400 | 22,000 | | 80.7 | 141.5 | 20,800 | | | | | 42 |
| 44 | 76.5 | 143.7 | 27,600 | 27,400 | 24,400 | 22,000 | 79.9 | 140.9 | 20,500 | 20,100 | | | | | 44 |
| 46 | 75.7 | 143.1 | 27,600 | 27,400 | 24,400 | 21,900 | 79.0 | 140.3 | 20,100 | 19,800 | | | | | 46 |
| 48 | 74.9 | 142.5 | 27,600 | 27,200 | 24,200 | 21,900 | 78.2 | 139.7 | 19,800 | 19,500 | 19,200 | | | | 48 |
| 50 | 74.0 | 141.8 | 27,600 | 27,200 | 24,200 | 21,900 | 77.3 | 139.0 | 19,500 | 19,200 | 18,900 | 16,500 | | | 50 |
| 55 | 71.9 | 140.1 | 27,600 | 27,000 | 24,100 | 21,700 | 75.1 | 137.2 | 18,800 | 18,500 | 18,200 | 16,500 | | | 55 |
| 60 | 69.7 | 138.1 | 27,600 | 26,600 | 23,900 | 21,600 | 72.9 | 135.1 | 18,200 | 17,900 | 17,600 | 16,500 | | | 60 |
| 65 | 67.5 | 135.8 | 25,500 | 24,000 | 22,600 | 21,400 | 70.6 | 132.8 | 17,600 | 17,300 | 17,100 | 16,400 | | | 65 |
| 70 | 65.3 | 133.4 | 23,000 | 21,700 | 20,600 | 19,500 | 68.3 | 130.3 | 17,000 | 16,800 | 16,600 | 16,400 | | | 70 |
| 75 | 63.0 | 130.6 | 20,900 | 19,800 | 18,800 | 17,900 | 66.0 | 127.5 | 16,500 | 16,300 | 16,100 | 16,000 | | | 75 |
| 80 | 60.6 | 127.7 | 19,000 | 18,100 | 17,200 | 16,400 | 63.6 | 124.5 | 16,100 | 15,900 | 15,700 | 15,600 | | | 80 |
| 85 | 58.2 | 124.4 | 17,500 | 16,600 | 15,900 | 15,100 | 61.1 | 121.1 | 15,600 | 15,500 | 15,300 | 15,200 | | | 85 |
| 90 | 55.7 | 120.8 | 16,000 | 15,300 | 14,700 | 14,000 | 58.6 | 117.4 | 15,300 | 15,100 | 15,000 | 14,300 | | | 90 |
| 95 | 53.2 | 116.9 | 14,800 | 14,200 | 13,600 | 13,000 | 55.9 | 113.4 | 14,900 | 14,500 | 13,900 | 13,300 | | | 95 |
| 100 | 50.5 | 112.6 | 13,700 | 13,100 | 12,600 | 12,100 | 53.2 | 108.9 | 13,900 | 13,400 | 12,800 | 12,300 | | | 100 |
| 105 | 47.7 | 107.8 | 12,700 | 12,200 | 11,700 | 11,300 | 50.3 | 104.0 | 12,900 | 12,400 | 11,900 | 11,500 | | | 105 |
| 110 | 44.8 | 102.6 | 11,800 | 11,300 | 10,900 | 10,500 | 47.3 | 98.6 | 12,000 | 11,500 | 11,100 | 10,700 | | | 110 |
| 115 | 41.7 | 96.8 | 11,000 | 10,600 | 10,200 | 9,800 | 44.0 | 92.5 | 11,100 | 10,700 | 10,300 | 10,000 | | | 115 |
| 120 | 38.4 | 90.3 | 10,200 | 9,900 | 9,500 | 9,200 | 40.5 | 85.6 | 10,300 | 10,000 | 9,600 | 9,300 | | | 120 |
| 125 | 34.8 | 82.9 | 9,500 | 9,200 | 8,900 | 8,600 | 36.7 | 77.7 | 9,600 | 9,300 | 9,000 | 8,700 | | | 125 |
| 130 | 30.8 | 74.3 | 8,900 | 8,600 | 8,300 | 8,100 | 32.4 | 68.4 | 8,900 | 8,600 | 8,400 | 8,100 | | | 130 |
| 135 | 26.2 | 64.0 | 8,300 | 8,000 | 7,800 | 7,600 | | | | | | | | | 135 |
| 140 | 20.6 | 50.9 | 7,700 | 7,500 | 7,300 | 7,100 | | | | | | | | | 140 |

MLC90A-1 S-2



73,000 lb
+
23,100 lb

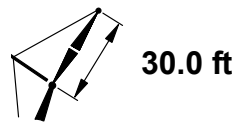
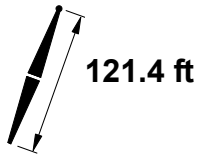

| | 10° | | | | | | | 30° | | | | | | | |
|-----|------|-------|--------|----------|----------|----------|----------|-------|--------|--------|----------|----------|----------|----------|-----|
| | | | | | | | | | | | | | | | |
| | ft | ° | ft | 0° lb | 1° lb | 2° lb | 3° lb | ft | ° | ft | 0° lb | 1° lb | 2° lb | 3° lb | ft |
| 36 | 80.5 | 155.8 | 27,600 | | | | | | | | | | | | 36 |
| 38 | 79.8 | 155.4 | 27,600 | 27,600 | | | | | | | | | | | 38 |
| 40 | 79.0 | 154.9 | 27,600 | 27,600 | 24,400 | | | | | | | | | | 40 |
| 42 | 78.2 | 154.4 | 27,600 | 27,500 | 24,400 | | | | | | | | | | 42 |
| 44 | 77.4 | 153.9 | 27,600 | 27,400 | 24,300 | 21,900 | | 80.6 | 151.1 | 20,700 | | | | | 44 |
| 46 | 76.7 | 153.4 | 27,600 | 27,300 | 24,200 | 21,800 | 79.8 | 150.5 | 20,400 | 20,000 | | | | | 46 |
| 48 | 75.9 | 152.8 | 27,600 | 27,300 | 24,100 | 21,800 | 79.0 | 149.9 | 20,100 | 19,800 | 19,400 | | | | 48 |
| 50 | 75.1 | 152.2 | 27,600 | 27,100 | 24,100 | 21,700 | 78.2 | 149.3 | 19,800 | 19,500 | 19,100 | | | | 50 |
| 55 | 73.1 | 150.5 | 27,600 | 27,000 | 24,000 | 21,700 | 76.1 | 147.6 | 19,100 | 18,800 | 18,500 | 16,200 | | | 55 |
| 60 | 71.1 | 148.7 | 27,600 | 26,300 | 23,900 | 21,600 | 74.1 | 145.7 | 18,500 | 18,200 | 17,900 | 16,200 | | | 60 |
| 65 | 69.1 | 146.6 | 25,200 | 23,600 | 22,200 | 20,900 | 72.0 | 143.6 | 17,900 | 17,700 | 17,400 | 16,100 | | | 65 |
| 70 | 67.0 | 144.3 | 22,700 | 21,400 | 20,200 | 19,000 | 69.9 | 141.3 | 17,400 | 17,200 | 16,900 | 16,100 | | | 70 |
| 75 | 64.9 | 141.8 | 20,600 | 19,500 | 18,400 | 17,400 | 67.7 | 138.8 | 16,900 | 16,700 | 16,500 | 16,100 | | | 75 |
| 80 | 62.7 | 139.1 | 18,800 | 17,800 | 16,900 | 16,000 | 65.5 | 136.0 | 16,400 | 16,200 | 16,100 | 15,900 | | | 80 |
| 85 | 60.5 | 136.1 | 17,200 | 16,300 | 15,500 | 14,700 | 63.3 | 132.9 | 16,000 | 15,800 | 15,700 | 15,100 | | | 85 |
| 90 | 58.3 | 132.9 | 15,800 | 15,000 | 14,300 | 13,600 | 61.0 | 129.6 | 15,600 | 15,400 | 14,600 | 13,900 | | | 90 |
| 95 | 56.0 | 129.4 | 14,500 | 13,900 | 13,200 | 12,600 | 58.6 | 125.9 | 14,900 | 14,200 | 13,500 | 12,900 | | | 95 |
| 100 | 53.6 | 125.5 | 13,400 | 12,800 | 12,200 | 11,700 | 56.2 | 122.0 | 13,700 | 13,100 | 12,500 | 12,000 | | | 100 |
| 105 | 51.2 | 121.3 | 12,400 | 11,900 | 11,400 | 10,900 | 53.6 | 117.6 | 12,700 | 12,100 | 11,600 | 11,100 | | | 105 |
| 110 | 48.6 | 116.7 | 11,500 | 11,000 | 10,600 | 10,100 | 51.0 | 112.9 | 11,700 | 11,300 | 10,800 | 10,300 | | | 110 |
| 115 | 45.9 | 111.7 | 10,700 | 10,300 | 9,800 | 9,400 | 48.2 | 107.7 | 10,900 | 10,400 | 10,000 | 9,600 | | | 115 |
| 120 | 43.1 | 106.1 | 9,900 | 9,600 | 9,200 | 8,800 | 45.3 | 101.9 | 10,100 | 9,700 | 9,300 | 9,000 | | | 120 |
| 125 | 40.1 | 100.0 | 9,300 | 8,900 | 8,600 | 8,200 | 42.2 | 95.5 | 9,400 | 9,000 | 8,700 | 8,400 | | | 125 |
| 130 | 36.9 | 93.2 | 8,600 | 8,300 | 8,000 | 7,700 | 38.8 | 88.2 | 8,700 | 8,400 | 8,100 | 7,800 | | | 130 |
| 135 | 33.5 | 85.4 | 8,000 | 7,700 | 7,500 | 7,200 | 35.1 | 79.9 | 8,100 | 7,800 | 7,500 | 7,300 | | | 135 |
| 140 | 29.6 | 76.4 | 7,500 | 7,200 | 7,000 | 6,700 | 30.9 | 70.2 | 7,500 | 7,300 | 7,000 | 6,800 | | | 140 |
| 145 | 25.1 | 65.6 | 7,000 | 6,700 | 6,500 | 6,300 | | | | | | | | | 145 |

MLC90A-1 S-2

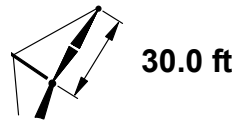
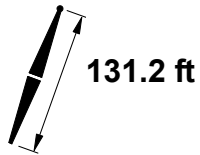
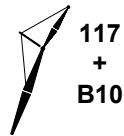

| | 10° | | | | | | | 30° | | | | | | | |
|-----|------|-------|--------|----------|----------|----------|----------|-------|--------|--------|----------|----------|----------|----------|-----|
| | | | | | | | | | | | | | | | |
| | ft | ° | ft | 0° lb | 1° lb | 2° lb | 3° lb | ft | ° | ft | 0° lb | 1° lb | 2° lb | 3° lb | ft |
| 38 | 80.4 | 165.5 | 27,600 | | | | | | | | | | | | 38 |
| 40 | 79.7 | 165.0 | 27,600 | 27,400 | | | | | | | | | | | 40 |
| 42 | 78.9 | 164.6 | 27,600 | 27,300 | 24,200 | | | | | | | | | | 42 |
| 44 | 78.2 | 164.1 | 27,600 | 27,200 | 24,100 | | | | | | | | | | 44 |
| 46 | 77.5 | 163.6 | 27,600 | 27,200 | 24,100 | 21,700 | | 80.4 | 160.7 | 20,700 | | | | | 46 |
| 48 | 76.8 | 163.0 | 27,600 | 27,100 | 24,000 | 21,600 | 79.7 | 160.1 | 20,400 | 20,000 | | | | | 48 |
| 50 | 76.0 | 162.5 | 27,600 | 27,000 | 24,000 | 21,600 | 78.9 | 159.6 | 20,100 | 19,700 | 18,900 | | | | 50 |
| 55 | 74.2 | 160.9 | 27,600 | 26,900 | 23,800 | 21,500 | 77.0 | 158.0 | 19,400 | 19,100 | 18,800 | 15,800 | | | 55 |
| 60 | 72.3 | 159.2 | 27,600 | 26,000 | 23,800 | 21,500 | 75.1 | 156.2 | 18,800 | 18,500 | 18,200 | 15,800 | | | 60 |
| 65 | 70.4 | 157.3 | 25,000 | 23,300 | 21,800 | 20,400 | 73.2 | 154.3 | 18,200 | 18,000 | 17,700 | 15,800 | | | 65 |
| 70 | 68.5 | 155.2 | 22,500 | 21,100 | 19,800 | 18,600 | 71.2 | 152.1 | 17,700 | 17,500 | 17,200 | 15,800 | | | 70 |
| 75 | 66.5 | 152.8 | 20,400 | 19,200 | 18,100 | 17,000 | 69.2 | 149.8 | 17,200 | 17,000 | 16,800 | 15,800 | | | 75 |
| 80 | 64.6 | 150.3 | 18,600 | 17,500 | 16,500 | 15,600 | 67.2 | 147.2 | 16,800 | 16,600 | 16,400 | 15,800 | | | 80 |
| 85 | 62.5 | 147.6 | 17,000 | 16,100 | 15,200 | 14,400 | 65.2 | 144.4 | 16,400 | 16,200 | 15,600 | 14,800 | | | 85 |
| 90 | 60.5 | 144.6 | 15,600 | 14,800 | 14,000 | 13,300 | 63.1 | 141.3 | 16,000 | 15,200 | 14,400 | 13,600 | | | 90 |
| 95 | 58.4 | 141.4 | 14,300 | 13,600 | 12,900 | 12,300 | 60.9 | 138.0 | 14,700 | 14,000 | 13,300 | 12,600 | | | 95 |
| 100 | 56.2 | 137.9 | 13,200 | 12,600 | 12,000 | 11,400 | 58.7 | 134.4 | 13,500 | 12,900 | 12,300 | 11,700 | | | 100 |
| 105 | 54.0 | 134.1 | 12,200 | 11,700 | 11,100 | 10,600 | 56.4 | 130.5 | 12,500 | 11,900 | 11,400 | 10,800 | | | 105 |
| 110 | 51.7 | 130.0 | 11,300 | 10,800 | 10,300 | 9,800 | 54.0 | 126.3 | 11,600 | 11,100 | 10,600 | 10,100 | | | 110 |
| 115 | 49.3 | 125.5 | 10,500 | 10,000 | 9,600 | 9,200 | 51.6 | 121.7 | 10,700 | 10,300 | 9,800 | 9,400 | | | 115 |
| 120 | 46.9 | 120.6 | 9,800 | 9,300 | 8,900 | 8,500 | 49.0 | 116.7 | 9,900 | 9,500 | 9,100 | 8,700 | | | 120 |
| 125 | 44.3 | 115.3 | 9,100 | 8,700 | 8,300 | 8,000 | 46.4 | 111.1 | 9,200 | 8,800 | 8,500 | 8,100 | | | 125 |
| 130 | 41.6 | 109.5 | 8,400 | 8,100 | 7,800 | 7,400 | 43.5 | 105.1 | 8,600 | 8,200 | 7,900 | 7,600 | | | 130 |
| 135 | 38.7 | 103.1 | 7,900 | 7,500 | 7,200 | 6,900 | 40.5 | 98.3 | 8,000 | 7,600 | 7,300 | 7,000 | | | 135 |
| 140 | 35.6 | 95.9 | 7,300 | 7,000 | 6,800 | 6,500 | 37.2 | 90.7 | 7,400 | 7,100 | 6,800 | 6,600 | | | 140 |
| 145 | 32.2 | 87.8 | 6,800 | 6,600 | 6,300 | 6,100 | 33.6 | 82.1 | 6,900 | 6,600 | 6,400 | 6,100 | | | 145 |
| 150 | 28.5 | 78.4 | 6,300 | 6,100 | 5,900 | 5,700 | | | | | | | | | 150 |
| 155 | 24.1 | 67.2 | 5,900 | 5,700 | 5,500 | 5,300 | | | | | | | | | 155 |

MLC90A-1 S-2



73,000 lb
+
23,100 lb

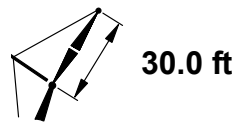
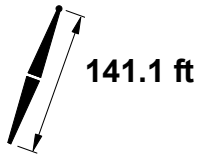

| | 10° | | | | | | | 30° | | | | | | |
|-----|------|-------|--------|----------|----------|----------|----------|------|-------|----------|----------|----------|----------|-----|
| | | | | | | | | | | | | | | |
| | ft | ° | ft | 0° lb | 1° lb | 2° lb | 3° lb | ° | ft | 0° lb | 1° lb | 2° lb | 3° lb | ft |
| 38 | 81.0 | 175.5 | 27,600 | | | | | | | | | | | 38 |
| 40 | 80.3 | 175.1 | 27,600 | | | | | | | | | | | 40 |
| 42 | 79.6 | 174.7 | 27,600 | 27,100 | | | | | | | | | | 42 |
| 44 | 78.9 | 174.2 | 27,600 | 27,100 | 23,900 | | | | | | | | | 44 |
| 46 | 78.2 | 173.7 | 27,600 | 27,000 | 23,900 | | | 81.0 | 170.8 | 20,900 | | | | 46 |
| 48 | 77.5 | 173.2 | 27,600 | 26,900 | 23,900 | 21,400 | | 80.3 | 170.3 | 20,600 | | | | 48 |
| 50 | 76.8 | 172.7 | 27,600 | 26,900 | 23,800 | 21,400 | | 79.6 | 169.8 | 20,300 | 20,000 | | | 50 |
| 55 | 75.1 | 171.2 | 27,600 | 26,800 | 23,700 | 21,300 | | 77.8 | 168.3 | 19,700 | 19,300 | 18,400 | 15,500 | 55 |
| 60 | 73.4 | 169.6 | 27,600 | 25,600 | 23,600 | 21,300 | | 76.0 | 166.6 | 19,100 | 18,800 | 18,400 | 15,500 | 60 |
| 65 | 71.6 | 167.8 | 24,700 | 23,000 | 21,400 | 20,000 | | 74.2 | 164.8 | 18,500 | 18,200 | 18,000 | 15,400 | 65 |
| 70 | 69.8 | 165.8 | 22,300 | 20,800 | 19,400 | 18,200 | | 72.4 | 162.8 | 18,000 | 17,800 | 17,500 | 15,400 | 70 |
| 75 | 68.0 | 163.7 | 20,100 | 18,900 | 17,700 | 16,600 | | 70.6 | 160.6 | 17,500 | 17,300 | 17,100 | 15,400 | 75 |
| 80 | 66.1 | 161.4 | 18,300 | 17,200 | 16,200 | 15,200 | | 68.7 | 158.2 | 17,100 | 16,900 | 16,700 | 15,400 | 80 |
| 85 | 64.3 | 158.8 | 16,700 | 15,700 | 14,800 | 14,000 | | 66.8 | 155.6 | 16,700 | 16,200 | 15,300 | 14,400 | 85 |
| 90 | 62.4 | 156.1 | 15,300 | 14,500 | 13,600 | 12,900 | | 64.8 | 152.8 | 15,800 | 14,900 | 14,100 | 13,300 | 90 |
| 95 | 60.4 | 153.1 | 14,100 | 13,300 | 12,600 | 11,900 | | 62.8 | 149.8 | 14,500 | 13,700 | 13,000 | 12,300 | 95 |
| 100 | 58.4 | 149.9 | 13,000 | 12,300 | 11,600 | 11,000 | | 60.8 | 146.5 | 13,300 | 12,600 | 12,000 | 11,300 | 100 |
| 105 | 56.4 | 146.4 | 12,000 | 11,400 | 10,800 | 10,200 | | 58.7 | 142.9 | 12,300 | 11,700 | 11,100 | 10,500 | 105 |
| 110 | 54.3 | 142.7 | 11,100 | 10,500 | 10,000 | 9,500 | | 56.6 | 139.1 | 11,300 | 10,800 | 10,300 | 9,700 | 110 |
| 115 | 52.2 | 138.6 | 10,300 | 9,700 | 9,300 | 8,800 | | 54.4 | 134.9 | 10,500 | 10,000 | 9,500 | 9,000 | 115 |
| 120 | 50.0 | 134.3 | 9,500 | 9,000 | 8,600 | 8,200 | | 52.1 | 130.5 | 9,700 | 9,300 | 8,800 | 8,400 | 120 |
| 125 | 47.7 | 129.6 | 8,800 | 8,400 | 8,000 | 7,600 | | 49.7 | 125.6 | 9,000 | 8,600 | 8,200 | 7,800 | 125 |
| 130 | 45.3 | 124.4 | 8,200 | 7,800 | 7,400 | 7,100 | | 47.3 | 120.3 | 8,300 | 8,000 | 7,600 | 7,300 | 130 |
| 135 | 42.8 | 118.9 | 7,600 | 7,300 | 6,900 | 6,600 | | 44.7 | 114.5 | 7,700 | 7,400 | 7,100 | 6,700 | 135 |
| 140 | 40.2 | 112.8 | 7,100 | 6,700 | 6,400 | 6,100 | | 41.9 | 108.1 | 7,200 | 6,900 | 6,600 | 6,300 | 140 |
| 145 | 37.4 | 106.0 | 6,500 | 6,300 | 6,000 | 5,700 | | 39.0 | 101.1 | 6,600 | 6,400 | 6,100 | 5,800 | 145 |
| 150 | 34.4 | 98.5 | 6,100 | 5,800 | 5,600 | 5,300 | | 35.8 | 93.1 | 6,100 | 5,900 | 5,600 | 5,400 | 150 |
| 155 | 31.1 | 90.1 | 5,600 | 5,400 | 5,200 | 5,000 | | 32.3 | 84.1 | 5,700 | 5,400 | 5,200 | 5,000 | 155 |
| 160 | 27.4 | 80.3 | 5,200 | 5,000 | 4,800 | 4,600 | | | | | | | | 160 |
| 165 | 23.2 | 68.6 | 4,800 | 4,600 | 4,500 | 4,300 | | | | | | | | 165 |

MLC90A-1 S-2

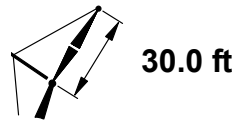
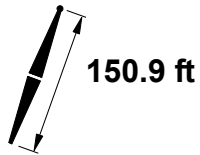
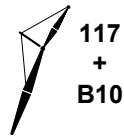

| | 10° | | | | | | | 30° | | | | | | | |
|-----|------|-------|--------|----------|----------|----------|----------|------|-------|--------|----------|----------|----------|----------|-----|
| | | | | | | | | | | | | | | | |
| | ft | ° | ft | 0° lb | 1° lb | 2° lb | 3° lb | ft | ° | ft | 0° lb | 1° lb | 2° lb | 3° lb | ft |
| 40 | 80.8 | 185.1 | 27,600 | | | | | | | | | | | | 40 |
| 42 | 80.2 | 184.7 | 27,600 | | | | | | | | | | | | 42 |
| 44 | 79.5 | 184.3 | 27,600 | 26,800 | | | | | | | | | | | 44 |
| 46 | 78.9 | 183.8 | 27,600 | 26,700 | 23,600 | | | | | | | | | | 46 |
| 48 | 78.2 | 183.4 | 27,600 | 26,700 | 23,600 | | | 80.8 | 180.4 | 20,800 | | | | | 48 |
| 50 | 77.6 | 182.8 | 27,600 | 26,700 | 23,500 | 19,400 | | 80.2 | 179.9 | 20,600 | | | | | 50 |
| 55 | 75.9 | 181.5 | 27,600 | 26,600 | 23,500 | 19,300 | | 78.5 | 178.5 | 19,900 | 19,600 | 18,000 | | | 55 |
| 60 | 74.3 | 180.0 | 27,400 | 25,200 | 23,300 | 19,200 | | 76.8 | 177.0 | 19,300 | 19,000 | 17,900 | 15,100 | | 60 |
| 65 | 72.6 | 178.3 | 24,500 | 22,700 | 21,000 | 19,100 | | 75.1 | 175.3 | 18,800 | 18,500 | 17,900 | 15,100 | | 65 |
| 70 | 70.9 | 176.4 | 22,000 | 20,400 | 19,000 | 17,700 | | 73.4 | 173.4 | 18,300 | 18,000 | 17,800 | 15,100 | | 70 |
| 75 | 69.2 | 174.4 | 19,900 | 18,500 | 17,300 | 16,200 | | 71.7 | 171.3 | 17,800 | 17,600 | 17,300 | 15,100 | | 75 |
| 80 | 67.5 | 172.2 | 18,100 | 16,900 | 15,800 | 14,800 | | 69.9 | 169.1 | 17,400 | 17,100 | 16,300 | 15,100 | | 80 |
| 85 | 65.8 | 169.9 | 16,500 | 15,500 | 14,500 | 13,600 | | 68.2 | 166.7 | 17,000 | 15,900 | 15,000 | 14,100 | | 85 |
| 90 | 64.0 | 167.3 | 15,100 | 14,200 | 13,300 | 12,500 | | 66.4 | 164.1 | 15,500 | 14,600 | 13,700 | 12,900 | | 90 |
| 95 | 62.2 | 164.5 | 13,800 | 13,000 | 12,300 | 11,500 | | 64.5 | 161.2 | 14,300 | 13,400 | 12,700 | 11,900 | | 95 |
| 100 | 60.4 | 161.6 | 12,700 | 12,000 | 11,300 | 10,700 | | 62.6 | 158.2 | 13,100 | 12,400 | 11,700 | 11,000 | | 100 |
| 105 | 58.5 | 158.4 | 11,700 | 11,100 | 10,500 | 9,900 | | 60.7 | 154.9 | 12,100 | 11,400 | 10,800 | 10,200 | | 105 |
| 110 | 56.6 | 154.9 | 10,800 | 10,200 | 9,700 | 9,100 | | 58.8 | 151.4 | 11,100 | 10,500 | 10,000 | 9,400 | | 110 |
| 115 | 54.6 | 151.2 | 10,000 | 9,500 | 9,000 | 8,500 | | 56.8 | 147.6 | 10,300 | 9,700 | 9,200 | 8,700 | | 115 |
| 120 | 52.6 | 147.3 | 9,300 | 8,800 | 8,300 | 7,900 | | 54.7 | 143.6 | 9,500 | 9,000 | 8,600 | 8,100 | | 120 |
| 125 | 50.5 | 143.0 | 8,600 | 8,100 | 7,700 | 7,300 | | 52.6 | 139.2 | 8,800 | 8,400 | 7,900 | 7,500 | | 125 |
| 130 | 48.4 | 138.4 | 7,900 | 7,500 | 7,200 | 6,800 | | 50.4 | 134.4 | 8,100 | 7,700 | 7,300 | 7,000 | | 130 |
| 135 | 46.2 | 133.4 | 7,400 | 7,000 | 6,600 | 6,300 | | 48.1 | 129.3 | 7,500 | 7,200 | 6,800 | 6,500 | | 135 |
| 140 | 43.9 | 128.1 | 6,800 | 6,500 | 6,200 | 5,800 | | 45.7 | 123.8 | 7,000 | 6,600 | 6,300 | 6,000 | | 140 |
| 145 | 41.4 | 122.2 | 6,300 | 6,000 | 5,700 | 5,400 | | 43.2 | 117.7 | 6,400 | 6,100 | 5,800 | 5,500 | | 145 |
| 150 | 38.9 | 115.9 | 5,900 | 5,600 | 5,300 | 5,000 | | 40.5 | 111.1 | 6,000 | 5,700 | 5,400 | 5,100 | | 150 |
| 155 | 36.2 | 108.9 | 5,400 | 5,200 | 4,900 | 4,700 | | 37.6 | 103.7 | 5,500 | 5,200 | 5,000 | 4,700 | | 155 |
| 160 | 33.2 | 101.1 | 5,000 | 4,800 | 4,500 | 4,300 | | 34.5 | 95.5 | 5,100 | 4,800 | 4,600 | 4,400 | | 160 |
| 165 | 30.1 | 92.3 | 4,600 | 4,400 | 4,200 | 4,000 | | 31.1 | 86.0 | 4,600 | 4,400 | 4,200 | 4,000 | | 165 |
| 170 | 26.5 | 82.1 | 4,200 | 4,100 | 3,900 | 3,700 | | | | | | | | | 170 |
| 175 | 22.3 | 70.0 | 3,700 | 3,600 | 3,500 | 3,400 | | | | | | | | | 175 |

MLC90A-1 S-2

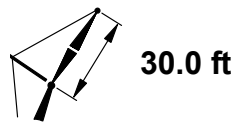
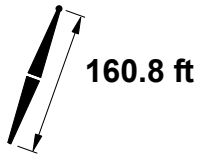
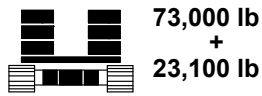

| | 10° | | | | | | | 30° | | | | | | | |
|-----|------|-------|--------|----------|----------|----------|----------|------|-------|--------|----------|----------|----------|----------|-----|
| | | | | | | | | | | | | | | | |
| | ft | ° | ft | 0° lb | 1° lb | 2° lb | 3° lb | ft | ° | ft | 0° lb | 1° lb | 2° lb | 3° lb | ft |
| 42 | 80.7 | 194.8 | 27,600 | | | | | | | | | | | | 42 |
| 44 | 80.1 | 194.4 | 27,600 | | | | | | | | | | | | 44 |
| 46 | 79.5 | 193.9 | 27,600 | 26,500 | | | | | | | | | | | 46 |
| 48 | 78.8 | 193.5 | 27,600 | 26,400 | 22,000 | | | | | | | | | | 48 |
| 50 | 78.2 | 193.0 | 27,600 | 26,400 | 22,000 | | | 80.7 | 190.0 | 20,800 | | | | | 50 |
| 55 | 76.7 | 191.7 | 27,600 | 26,300 | 21,800 | 17,000 | | 79.1 | 188.7 | 20,200 | 19,800 | | | | 55 |
| 60 | 75.1 | 190.3 | 27,200 | 24,900 | 21,700 | 16,900 | | 77.6 | 187.3 | 19,600 | 19,200 | 17,600 | 14,700 | | 60 |
| 65 | 73.6 | 188.7 | 24,200 | 22,300 | 20,600 | 16,900 | | 76.0 | 185.6 | 19,100 | 18,700 | 17,500 | 14,700 | | 65 |
| 70 | 72.0 | 186.9 | 21,700 | 20,100 | 18,600 | 16,800 | | 74.3 | 183.9 | 18,600 | 18,300 | 17,400 | 14,700 | | 70 |
| 75 | 70.4 | 185.0 | 19,600 | 18,200 | 16,900 | 15,700 | | 72.7 | 182.0 | 18,100 | 17,800 | 17,400 | 14,700 | | 75 |
| 80 | 68.8 | 183.0 | 17,800 | 16,600 | 15,400 | 14,400 | | 71.1 | 179.9 | 17,700 | 17,200 | 16,000 | 14,600 | | 80 |
| 85 | 67.1 | 180.8 | 16,200 | 15,100 | 14,100 | 13,200 | | 69.4 | 177.6 | 16,800 | 15,700 | 14,600 | 13,700 | | 85 |
| 90 | 65.5 | 178.4 | 14,800 | 13,900 | 13,000 | 12,100 | | 67.7 | 175.1 | 15,300 | 14,300 | 13,400 | 12,600 | | 90 |
| 95 | 63.8 | 175.8 | 13,600 | 12,700 | 11,900 | 11,200 | | 66.0 | 172.5 | 14,000 | 13,200 | 12,300 | 11,600 | | 95 |
| 100 | 62.1 | 173.0 | 12,500 | 11,700 | 11,000 | 10,300 | | 64.3 | 169.7 | 12,900 | 12,100 | 11,400 | 10,700 | | 100 |
| 105 | 60.3 | 170.0 | 11,500 | 10,800 | 10,100 | 9,500 | | 62.5 | 166.6 | 11,800 | 11,100 | 10,500 | 9,800 | | 105 |
| 110 | 58.5 | 166.8 | 10,600 | 9,900 | 9,300 | 8,800 | | 60.7 | 163.4 | 10,900 | 10,300 | 9,700 | 9,100 | | 110 |
| 115 | 56.7 | 163.4 | 9,700 | 9,200 | 8,600 | 8,100 | | 58.8 | 159.9 | 10,100 | 9,500 | 8,900 | 8,400 | | 115 |
| 120 | 54.9 | 159.8 | 9,000 | 8,500 | 8,000 | 7,500 | | 56.9 | 156.2 | 9,300 | 8,800 | 8,300 | 7,800 | | 120 |
| 125 | 53.0 | 155.9 | 8,300 | 7,800 | 7,400 | 7,000 | | 55.0 | 152.2 | 8,600 | 8,100 | 7,600 | 7,200 | | 125 |
| 130 | 51.0 | 151.7 | 7,700 | 7,300 | 6,800 | 6,400 | | 53.0 | 147.9 | 7,900 | 7,500 | 7,100 | 6,600 | | 130 |
| 135 | 49.0 | 147.2 | 7,100 | 6,700 | 6,300 | 6,000 | | 50.9 | 143.3 | 7,300 | 6,900 | 6,500 | 6,100 | | 135 |
| 140 | 46.9 | 142.4 | 6,600 | 6,200 | 5,800 | 5,500 | | 48.8 | 138.3 | 6,700 | 6,400 | 6,000 | 5,700 | | 140 |
| 145 | 44.8 | 137.2 | 6,100 | 5,700 | 5,400 | 5,100 | | 46.5 | 132.9 | 6,200 | 5,900 | 5,600 | 5,200 | | 145 |
| 150 | 42.5 | 131.6 | 5,600 | 5,300 | 5,000 | 4,700 | | 44.2 | 127.1 | 5,700 | 5,400 | 5,100 | 4,800 | | 150 |
| 155 | 40.2 | 125.5 | 5,100 | 4,900 | 4,600 | 4,300 | | 41.8 | 120.8 | 5,300 | 5,000 | 4,700 | 4,400 | | 155 |
| 160 | 37.7 | 118.9 | 4,700 | 4,500 | 4,200 | 4,000 | | 39.2 | 113.9 | 4,800 | 4,600 | 4,300 | 4,100 | | 160 |
| 165 | 35.1 | 111.6 | 4,400 | 4,100 | 3,900 | 3,700 | | 36.4 | 106.2 | 4,400 | 4,200 | 4,000 | 3,700 | | 165 |
| 170 | 32.2 | 103.5 | 4,000 | 3,800 | 3,600 | 3,400 | | 33.4 | 97.7 | 4,000 | 3,800 | 3,600 | 3,400 | | 170 |
| 175 | 29.1 | 94.4 | 3,600 | 3,400 | 3,300 | 3,100 | | | | | | | | | 175 |
| 180 | 25.6 | 83.8 | 3,100 | 2,900 | 2,800 | 2,700 | | | | | | | | | 180 |
| 185 | 21.6 | 71.2 | 2,500 | 2,500 | 2,400 | 2,300 | | | | | | | | | 185 |

MLC90A-1 S-2

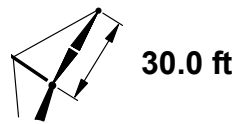
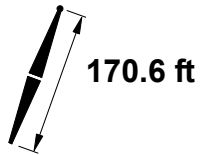
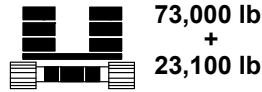
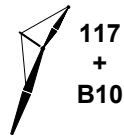

| ft | 10° | | | | | | 30° | | | | | | ft |
|-----|------|-------|---------------|--------|--------|--------|------|-------|---------------|--------|--------|--------|-----|
| | ° | ft | Counterweight | | | | ° | ft | Counterweight | | | | |
| | | | 0° | 1° | 2° | 3° | | | 0° | 1° | 2° | 3° | |
| lb | lb | lb | lb | lb | lb | lb | lb | lb | lb | lb | lb | | |
| 44 | 80.6 | 204.4 | 27,600 | | | | | | | | | | 44 |
| 46 | 80.0 | 204.0 | 27,600 | 26,100 | | | | | | | | | 46 |
| 48 | 79.4 | 203.6 | 27,600 | 26,100 | | | | | | | | | 48 |
| 50 | 78.8 | 203.1 | 27,600 | 26,000 | 19,600 | | | | | | | | 50 |
| 55 | 77.4 | 201.9 | 27,600 | 25,900 | 19,400 | 15,000 | 79.7 | 198.9 | 20,400 | 20,000 | | | 55 |
| 60 | 75.9 | 200.5 | 26,900 | 24,500 | 19,300 | 14,900 | 78.2 | 197.5 | 19,800 | 19,500 | 17,100 | | 60 |
| 65 | 74.4 | 199.0 | 24,000 | 22,000 | 19,200 | 14,800 | 76.7 | 196.0 | 19,300 | 19,000 | 17,100 | 13,100 | 65 |
| 70 | 72.9 | 197.4 | 21,500 | 19,800 | 18,300 | 14,700 | 75.2 | 194.3 | 18,800 | 18,500 | 17,000 | 13,100 | 70 |
| 75 | 71.4 | 195.6 | 19,400 | 17,900 | 16,600 | 14,700 | 73.6 | 192.5 | 18,300 | 18,100 | 16,900 | 13,100 | 75 |
| 80 | 69.9 | 193.6 | 17,600 | 16,300 | 15,100 | 14,000 | 72.1 | 190.5 | 17,900 | 16,900 | 15,700 | 13,000 | 80 |
| 85 | 68.3 | 191.5 | 16,000 | 14,900 | 13,800 | 12,800 | 70.5 | 188.4 | 16,600 | 15,400 | 14,300 | 12,900 | 85 |
| 90 | 66.7 | 189.3 | 14,600 | 13,600 | 12,700 | 11,800 | 68.9 | 186.1 | 15,100 | 14,100 | 13,100 | 12,300 | 90 |
| 95 | 65.2 | 186.9 | 13,400 | 12,500 | 11,600 | 10,800 | 67.3 | 183.6 | 13,800 | 12,900 | 12,100 | 11,300 | 95 |
| 100 | 63.6 | 184.3 | 12,200 | 11,400 | 10,700 | 10,000 | 65.7 | 181.0 | 12,700 | 11,900 | 11,100 | 10,400 | 100 |
| 105 | 61.9 | 181.5 | 11,300 | 10,500 | 9,800 | 9,200 | 64.0 | 178.1 | 11,600 | 10,900 | 10,200 | 9,600 | 105 |
| 110 | 60.3 | 178.5 | 10,400 | 9,700 | 9,100 | 8,500 | 62.3 | 175.1 | 10,700 | 10,000 | 9,400 | 8,800 | 110 |
| 115 | 58.6 | 175.3 | 9,500 | 8,900 | 8,400 | 7,800 | 60.6 | 171.9 | 9,900 | 9,300 | 8,700 | 8,100 | 115 |
| 120 | 56.9 | 171.9 | 8,800 | 8,200 | 7,700 | 7,200 | 58.8 | 168.4 | 9,100 | 8,500 | 8,000 | 7,500 | 120 |
| 125 | 55.1 | 168.3 | 8,100 | 7,600 | 7,100 | 6,700 | 57.1 | 164.7 | 8,400 | 7,900 | 7,400 | 6,900 | 125 |
| 130 | 53.3 | 164.5 | 7,500 | 7,000 | 6,600 | 6,200 | 55.2 | 160.8 | 7,700 | 7,300 | 6,800 | 6,400 | 130 |
| 135 | 51.5 | 160.4 | 6,900 | 6,500 | 6,100 | 5,700 | 53.3 | 156.5 | 7,100 | 6,700 | 6,300 | 5,900 | 135 |
| 140 | 49.6 | 156.0 | 6,400 | 6,000 | 5,600 | 5,200 | 51.4 | 152.0 | 6,600 | 6,200 | 5,800 | 5,400 | 140 |
| 145 | 47.6 | 151.3 | 5,900 | 5,500 | 5,200 | 4,800 | 49.4 | 147.2 | 6,000 | 5,700 | 5,300 | 5,000 | 145 |
| 150 | 45.6 | 146.2 | 5,400 | 5,100 | 4,700 | 4,400 | 47.3 | 142.0 | 5,500 | 5,200 | 4,900 | 4,600 | 150 |
| 155 | 43.5 | 140.8 | 5,000 | 4,700 | 4,400 | 4,100 | 45.1 | 136.4 | 5,100 | 4,800 | 4,500 | 4,200 | 155 |
| 160 | 41.3 | 135.0 | 4,500 | 4,300 | 4,000 | 3,700 | 42.9 | 130.4 | 4,700 | 4,400 | 4,100 | 3,800 | 160 |
| 165 | 39.0 | 128.7 | 4,200 | 3,900 | 3,700 | 3,400 | 40.5 | 123.8 | 4,300 | 4,000 | 3,700 | 3,500 | 165 |
| 170 | 36.6 | 121.8 | 3,800 | 3,600 | 3,300 | 3,100 | 37.9 | 116.6 | 3,900 | 3,600 | 3,400 | 3,200 | 170 |
| 175 | 34.0 | 114.2 | 3,500 | 3,200 | 3,000 | 2,800 | 35.2 | 108.7 | 3,500 | 3,300 | 3,100 | 2,900 | 175 |
| 180 | 31.3 | 105.8 | 3,000 | 2,900 | 2,700 | 2,500 | 32.3 | 99.8 | 3,100 | 2,900 | 2,800 | 2,600 | 180 |
| 185 | 28.2 | 96.4 | 2,500 | 2,400 | 2,300 | 2,200 | | | | | | | 185 |
| 190 | 24.8 | 85.5 | 2,100 | 2,000 | | | | | | | | | 190 |

MLC90A-1 S-2



73,000 lb
+
23,100 lb

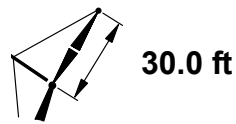
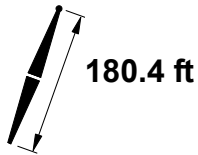

| | 10° | | | | | | | 30° | | | | | | |
|-----|------|-------|--------|----------|----------|----------|----------|------|-------|----------|----------|----------|----------|-----|
| | | | | | | | | | | | | | | |
| | ft | ° | ft | 0° lb | 1° lb | 2° lb | 3° lb | ° | ft | 0° lb | 1° lb | 2° lb | 3° lb | ft |
| 46 | 80.5 | 214.0 | 27,600 | | | | | | | | | | | 46 |
| 48 | 79.9 | 213.6 | 27,600 | 23,100 | | | | | | | | | | 48 |
| 50 | 79.3 | 213.2 | 27,600 | 23,100 | | | | | | | | | | 50 |
| 55 | 78.0 | 212.0 | 27,600 | 22,900 | 17,200 | 13,100 | | 80.2 | 209.0 | 20,500 | | | | 55 |
| 60 | 76.6 | 210.7 | 26,700 | 22,800 | 17,100 | 13,100 | | 78.8 | 207.7 | 20,000 | 19,600 | 15,300 | | 60 |
| 65 | 75.1 | 209.3 | 23,700 | 21,600 | 17,000 | 13,000 | | 77.3 | 206.3 | 19,500 | 19,200 | 15,300 | 11,600 | 65 |
| 70 | 73.7 | 207.7 | 21,300 | 19,500 | 16,900 | 12,900 | | 75.9 | 204.7 | 19,000 | 18,700 | 15,300 | 11,500 | 70 |
| 75 | 72.3 | 206.0 | 19,200 | 17,600 | 16,200 | 12,800 | | 74.4 | 202.9 | 18,600 | 18,300 | 15,200 | 11,500 | 75 |
| 80 | 70.8 | 204.2 | 17,300 | 16,000 | 14,800 | 12,800 | | 73.0 | 201.1 | 18,000 | 16,600 | 15,100 | 11,400 | 80 |
| 85 | 69.4 | 202.2 | 15,700 | 14,600 | 13,500 | 12,500 | | 71.5 | 199.1 | 16,300 | 15,100 | 14,000 | 11,400 | 85 |
| 90 | 67.9 | 200.1 | 14,300 | 13,300 | 12,300 | 11,400 | | 70.0 | 196.9 | 14,900 | 13,800 | 12,800 | 11,400 | 90 |
| 95 | 66.4 | 197.8 | 13,100 | 12,200 | 11,300 | 10,500 | | 68.5 | 194.6 | 13,600 | 12,600 | 11,800 | 10,900 | 95 |
| 100 | 64.9 | 195.4 | 12,000 | 11,100 | 10,400 | 9,600 | | 66.9 | 192.1 | 12,500 | 11,600 | 10,800 | 10,000 | 100 |
| 105 | 63.4 | 192.7 | 11,000 | 10,200 | 9,500 | 8,800 | | 65.4 | 189.4 | 11,400 | 10,600 | 9,900 | 9,200 | 105 |
| 110 | 61.8 | 189.9 | 10,100 | 9,400 | 8,700 | 8,100 | | 63.8 | 186.6 | 10,500 | 9,800 | 9,100 | 8,500 | 110 |
| 115 | 60.2 | 187.0 | 9,300 | 8,600 | 8,100 | 7,500 | | 62.2 | 183.5 | 9,600 | 9,000 | 8,400 | 7,800 | 115 |
| 120 | 58.6 | 183.8 | 8,500 | 8,000 | 7,400 | 6,900 | | 60.5 | 180.3 | 8,900 | 8,300 | 7,700 | 7,200 | 120 |
| 125 | 57.0 | 180.4 | 7,800 | 7,300 | 6,800 | 6,300 | | 58.9 | 176.9 | 8,100 | 7,600 | 7,100 | 6,600 | 125 |
| 130 | 55.3 | 176.9 | 7,200 | 6,700 | 6,300 | 5,800 | | 57.2 | 173.2 | 7,500 | 7,000 | 6,500 | 6,100 | 130 |
| 135 | 53.6 | 173.1 | 6,600 | 6,200 | 5,800 | 5,400 | | 55.4 | 169.3 | 6,900 | 6,400 | 6,000 | 5,600 | 135 |
| 140 | 51.9 | 169.0 | 6,100 | 5,700 | 5,300 | 4,900 | | 53.6 | 165.2 | 6,300 | 5,900 | 5,500 | 5,100 | 140 |
| 145 | 50.1 | 164.7 | 5,600 | 5,200 | 4,900 | 4,500 | | 51.8 | 160.8 | 5,800 | 5,400 | 5,000 | 4,700 | 145 |
| 150 | 48.2 | 160.1 | 5,100 | 4,800 | 4,400 | 4,100 | | 49.9 | 156.1 | 5,300 | 5,000 | 4,600 | 4,300 | 150 |
| 155 | 46.3 | 155.2 | 4,700 | 4,400 | 4,100 | 3,800 | | 48.0 | 151.0 | 4,900 | 4,500 | 4,200 | 3,900 | 155 |
| 160 | 44.4 | 150.0 | 4,300 | 4,000 | 3,700 | 3,400 | | 45.9 | 145.6 | 4,400 | 4,100 | 3,800 | 3,500 | 160 |
| 165 | 42.3 | 144.3 | 3,900 | 3,600 | 3,400 | 3,100 | | 43.8 | 139.8 | 4,000 | 3,700 | 3,500 | 3,200 | 165 |
| 170 | 40.2 | 138.3 | 3,500 | 3,300 | 3,000 | 2,800 | | 41.6 | 133.5 | 3,600 | 3,400 | 3,100 | 2,900 | 170 |
| 175 | 38.0 | 131.7 | 3,200 | 3,000 | 2,700 | 2,500 | | 39.3 | 126.7 | 3,300 | 3,000 | 2,800 | 2,600 | 175 |
| 180 | 35.6 | 124.6 | 2,800 | 2,600 | 2,400 | 2,200 | | 36.8 | 119.2 | 2,900 | 2,700 | 2,500 | 2,300 | 180 |
| 185 | 33.1 | 116.8 | 2,300 | 2,200 | 2,100 | | | 34.2 | 111.0 | 2,400 | 2,300 | 2,100 | 2,000 | 185 |
| 190 | | | | | | | | 31.3 | 101.8 | 2,000 | | | | 190 |

MLC90A-1 S-2

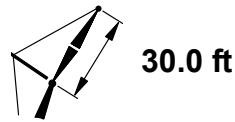
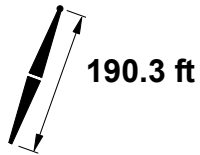
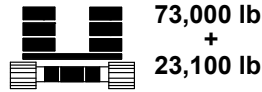
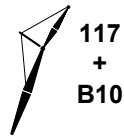

| ft | 10° | | | | | | | | 30° | | | | | | | | ft | |
|-----|------|-------|--------|--------|--------|--------|----|------|-------|--------|--------|--------|--------|----|----|---|----|-----|
| | 0° | | | | 1° | | | | 0° | | | | 1° | | | | | |
| | lb | lb | lb | lb | lb | lb | lb | lb | ft | ° | lb | lb | lb | lb | ft | ° | | |
| 46 | 80.9 | 224.0 | 27,600 | | | | | | | | | | | | | | | 46 |
| 48 | 80.4 | 223.7 | 27,600 | | | | | | | | | | | | | | | 48 |
| 50 | 79.8 | 223.2 | 27,600 | 20,400 | | | | | | | | | | | | | | 50 |
| 55 | 78.5 | 222.1 | 27,000 | 20,400 | 15,200 | | | 80.6 | 219.1 | 20,700 | | | | | | | | 55 |
| 60 | 77.2 | 220.9 | 26,200 | 20,300 | 15,200 | 11,400 | | 79.3 | 217.9 | 20,200 | 18,300 | | | | | | | 60 |
| 65 | 75.8 | 219.5 | 23,400 | 20,100 | 15,100 | 11,400 | | 77.9 | 216.5 | 19,700 | 18,200 | 13,500 | 10,200 | | | | | 65 |
| 70 | 74.5 | 218.1 | 21,000 | 19,100 | 15,100 | 11,300 | | 76.6 | 215.0 | 19,200 | 18,100 | 13,500 | 10,200 | | | | | 70 |
| 75 | 73.1 | 216.5 | 18,900 | 17,300 | 15,000 | 11,300 | | 75.2 | 213.3 | 18,800 | 18,000 | 13,500 | 10,100 | | | | | 75 |
| 80 | 71.7 | 214.7 | 17,000 | 15,600 | 14,400 | 11,200 | | 73.8 | 211.6 | 17,700 | 16,300 | 13,500 | 10,100 | | | | | 80 |
| 85 | 70.4 | 212.8 | 15,500 | 14,200 | 13,100 | 11,200 | | 72.4 | 209.7 | 16,100 | 14,800 | 13,500 | 10,100 | | | | | 85 |
| 90 | 69.0 | 210.8 | 14,100 | 13,000 | 11,900 | 11,000 | | 71.0 | 207.6 | 14,600 | 13,500 | 12,500 | 10,100 | | | | | 90 |
| 95 | 67.5 | 208.6 | 12,800 | 11,800 | 10,900 | 10,100 | | 69.5 | 205.4 | 13,300 | 12,300 | 11,400 | 10,100 | | | | | 95 |
| 100 | 66.1 | 206.3 | 11,700 | 10,800 | 10,000 | 9,200 | | 68.1 | 203.1 | 12,200 | 11,300 | 10,500 | 9,700 | | | | | 100 |
| 105 | 64.7 | 203.8 | 10,700 | 9,900 | 9,200 | 8,500 | | 66.6 | 200.5 | 11,200 | 10,300 | 9,600 | 8,900 | | | | | 105 |
| 110 | 63.2 | 201.2 | 9,800 | 9,100 | 8,400 | 7,800 | | 65.1 | 197.9 | 10,200 | 9,500 | 8,800 | 8,100 | | | | | 110 |
| 115 | 61.7 | 198.4 | 9,000 | 8,300 | 7,700 | 7,100 | | 63.6 | 195.0 | 9,400 | 8,700 | 8,100 | 7,500 | | | | | 115 |
| 120 | 60.2 | 195.4 | 8,200 | 7,600 | 7,100 | 6,500 | | 62.1 | 192.0 | 8,600 | 8,000 | 7,400 | 6,900 | | | | | 120 |
| 125 | 58.7 | 192.3 | 7,600 | 7,000 | 6,500 | 6,000 | | 60.5 | 188.8 | 7,900 | 7,300 | 6,800 | 6,300 | | | | | 125 |
| 130 | 57.1 | 189.0 | 6,900 | 6,400 | 5,900 | 5,500 | | 58.9 | 185.4 | 7,200 | 6,700 | 6,200 | 5,800 | | | | | 130 |
| 135 | 55.5 | 185.4 | 6,300 | 5,900 | 5,400 | 5,000 | | 57.3 | 181.8 | 6,600 | 6,100 | 5,700 | 5,300 | | | | | 135 |
| 140 | 53.9 | 181.6 | 5,800 | 5,400 | 5,000 | 4,600 | | 55.6 | 177.9 | 6,100 | 5,600 | 5,200 | 4,800 | | | | | 140 |
| 145 | 52.2 | 177.6 | 5,300 | 4,900 | 4,500 | 4,200 | | 53.9 | 173.8 | 5,500 | 5,100 | 4,700 | 4,400 | | | | | 145 |
| 150 | 50.5 | 173.4 | 4,800 | 4,500 | 4,100 | 3,800 | | 52.2 | 169.5 | 5,000 | 4,700 | 4,300 | 4,000 | | | | | 150 |
| 155 | 48.8 | 168.9 | 4,400 | 4,100 | 3,700 | 3,400 | | 50.4 | 164.9 | 4,600 | 4,200 | 3,900 | 3,600 | | | | | 155 |
| 160 | 47.0 | 164.1 | 4,000 | 3,700 | 3,400 | 3,100 | | 48.6 | 160.0 | 4,200 | 3,800 | 3,500 | 3,200 | | | | | 160 |
| 165 | 45.2 | 159.0 | 3,600 | 3,300 | 3,000 | 2,800 | | 46.7 | 154.7 | 3,800 | 3,500 | 3,200 | 2,900 | | | | | 165 |
| 170 | 43.2 | 153.6 | 3,300 | 3,000 | 2,700 | 2,500 | | 44.7 | 149.1 | 3,400 | 3,100 | 2,800 | 2,600 | | | | | 170 |
| 175 | 41.2 | 147.7 | 2,900 | 2,700 | 2,400 | 2,200 | | 42.6 | 143.1 | 3,000 | 2,800 | 2,500 | 2,300 | | | | | 175 |
| 180 | 39.2 | 141.4 | 2,500 | 2,300 | 2,100 | | | 40.5 | 136.6 | 2,700 | 2,400 | 2,200 | 2,000 | | | | | 180 |
| 185 | 37.0 | 134.7 | 2,100 | | | | | 38.2 | 129.5 | 2,200 | 2,000 | | | | | | | 185 |

MLC90A-1 S-2

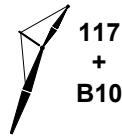

73,000 lb
+
23,100 lb

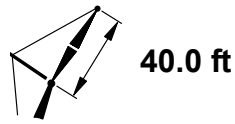
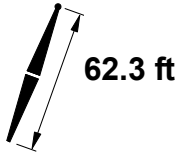

| | 10° | | | | | | 30° | | | | | | | |
|-----|------|-------|--------|--------|--------|--------|------|------|--------|--------|--------|--------|----|-----|
| | | | | | | | | | | | | | | |
| | | | | 0° | 1° | 2° | 3° | | | 0° | 1° | 2° | | 3° |
| ft | ° | ft | lb | lb | lb | lb | ° | ft | lb | lb | lb | lb | ft | |
| 30 | 80.9 | 106.8 | 26,500 | | | | | | | | | | | 30 |
| 32 | 79.7 | 106.3 | 26,200 | 23,000 | | | | | | | | | | 32 |
| 34 | 78.6 | 105.7 | 25,900 | 22,800 | 20,000 | | | | | | | | | 34 |
| 36 | 77.4 | 105.1 | 25,700 | 22,700 | 19,900 | 17,800 | | | | | | | | 36 |
| 38 | 76.2 | 104.4 | 25,400 | 22,400 | 19,800 | 17,700 | | | | | | | | 38 |
| 40 | 75.0 | 103.7 | 25,200 | 22,300 | 19,600 | 17,600 | | | | | | | | 40 |
| 42 | 73.8 | 102.9 | 25,000 | 22,100 | 19,500 | 17,400 | 80.1 | 99.8 | 16,400 | | | | | 42 |
| 44 | 72.6 | 102.1 | 24,700 | 21,900 | 19,300 | 17,300 | 78.8 | 99.0 | 16,100 | 15,800 | 15,500 | | | 44 |
| 46 | 71.4 | 101.3 | 24,600 | 21,800 | 19,200 | 17,200 | 77.6 | 98.1 | 15,700 | 15,400 | 15,200 | 13,800 | | 46 |
| 48 | 70.2 | 100.4 | 24,300 | 21,600 | 19,100 | 17,100 | 76.3 | 97.1 | 15,300 | 15,100 | 14,800 | 13,600 | | 48 |
| 50 | 69.0 | 99.4 | 24,100 | 21,500 | 19,000 | 17,000 | 75.0 | 96.2 | 15,000 | 14,800 | 14,500 | 13,400 | | 50 |
| 55 | 65.8 | 96.8 | 23,700 | 21,100 | 18,700 | 16,800 | 71.8 | 93.4 | 14,300 | 14,100 | 13,900 | 13,000 | | 55 |
| 60 | 62.6 | 93.8 | 23,300 | 20,800 | 18,500 | 16,700 | 68.4 | 90.3 | 13,600 | 13,400 | 13,300 | 12,600 | | 60 |
| 65 | 59.2 | 90.4 | 22,500 | 20,500 | 18,200 | 16,500 | 64.9 | 86.8 | 13,000 | 12,900 | 12,700 | 12,200 | | 65 |
| 70 | 55.7 | 86.5 | 21,100 | 20,300 | 18,000 | 16,300 | 61.2 | 82.7 | 12,500 | 12,400 | 12,200 | 11,900 | | 70 |
| 75 | 52.0 | 82.2 | 19,900 | 19,300 | 17,900 | 16,200 | 57.3 | 78.1 | 12,000 | 11,900 | 11,800 | 11,600 | | 75 |
| 80 | 48.1 | 77.2 | 18,900 | 18,200 | 17,500 | 16,000 | 53.1 | 72.8 | 11,600 | 11,500 | 11,500 | 11,300 | | 80 |
| 85 | 43.8 | 71.4 | 17,900 | 17,300 | 16,700 | 15,900 | 48.6 | 66.6 | 11,300 | 11,200 | 11,100 | 11,000 | | 85 |
| 90 | 39.1 | 64.6 | 17,100 | 16,600 | 16,100 | 15,500 | 43.4 | 59.2 | 11,000 | 10,900 | 10,900 | 10,900 | | 90 |
| 95 | 33.8 | 56.4 | 16,200 | 15,800 | 15,400 | 15,000 | 37.4 | 49.9 | 10,800 | 10,700 | 10,700 | 10,700 | | 95 |
| 100 | 27.3 | 45.9 | 15,000 | 14,700 | 14,400 | 14,100 | | | | | | | | 100 |

MLC90A-1 S-2

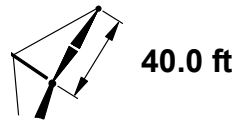
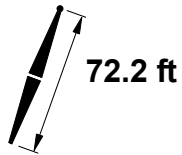
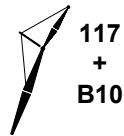

| | | 10° | | | | | | 30° | | | | | | | |
|-----|------|-------|--------|----|--------|----|--------|--------|--------|-------|--------|--------|--------|--------|-----|
| | | | | | | | | | | | | | | | |
| | | | | | | | | | | | | | | | |
| | | 0° | | | | 1° | | 0° | | | | 1° | | | |
| | | | | | | | | | | | | | | | |
| | | lb | | | | lb | | lb | | | | lb | | | |
| | | ft | | ft | | ft | | ft | | ft | | ft | | ft | |
| | | ° | | ° | | ° | | ° | | ° | | ° | | ° | |
| 32 | 80.6 | 116.4 | 26,300 | | | | | | | | | | | | 32 |
| 34 | 79.6 | 115.9 | 26,100 | | 22,900 | | | | | | | | | | 34 |
| 36 | 78.5 | 115.3 | 25,900 | | 22,800 | | 20,000 | | | | | | | | 36 |
| 38 | 77.5 | 114.7 | 25,600 | | 22,600 | | 19,800 | | 17,700 | | | | | | 38 |
| 40 | 76.4 | 114.1 | 25,400 | | 22,400 | | 19,700 | | 17,600 | | | | | | 40 |
| 42 | 75.3 | 113.4 | 25,300 | | 22,200 | | 19,600 | 17,500 | 81.0 | 110.1 | 16,700 | | | | 42 |
| 44 | 74.2 | 112.7 | 25,000 | | 22,100 | | 19,500 | 17,400 | 79.9 | 109.4 | 16,400 | 16,100 | | | 44 |
| 46 | 73.2 | 111.9 | 24,800 | | 21,900 | | 19,400 | 17,300 | 78.8 | 108.6 | 16,000 | 15,700 | 15,400 | | 46 |
| 48 | 72.1 | 111.1 | 24,700 | | 21,800 | | 19,300 | 17,300 | 77.6 | 107.7 | 15,700 | 15,400 | 15,200 | 13,200 | 48 |
| 50 | 71.0 | 110.2 | 24,500 | | 21,700 | | 19,100 | 17,200 | 76.5 | 106.9 | 15,400 | 15,100 | 14,900 | 13,200 | 50 |
| 55 | 68.2 | 107.9 | 24,100 | | 21,300 | | 18,900 | 17,000 | 73.6 | 104.4 | 14,700 | 14,400 | 14,200 | 13,200 | 55 |
| 60 | 65.3 | 105.2 | 23,600 | | 21,000 | | 18,600 | 16,700 | 70.6 | 101.7 | 14,000 | 13,800 | 13,600 | 13,200 | 60 |
| 65 | 62.3 | 102.2 | 23,300 | | 20,700 | | 18,400 | 16,600 | 67.5 | 98.6 | 13,400 | 13,300 | 13,100 | 12,900 | 65 |
| 70 | 59.3 | 98.9 | 22,500 | | 20,500 | | 18,200 | 16,400 | 64.4 | 95.1 | 12,900 | 12,800 | 12,600 | 12,500 | 70 |
| 75 | 56.1 | 95.1 | 21,200 | | 20,300 | | 18,000 | 16,300 | 61.0 | 91.1 | 12,500 | 12,300 | 12,200 | 12,100 | 75 |
| 80 | 52.8 | 90.9 | 20,100 | | 19,500 | | 18,000 | 16,200 | 57.5 | 86.7 | 12,000 | 11,900 | 11,800 | 11,700 | 80 |
| 85 | 49.2 | 86.1 | 18,700 | | 18,000 | | 17,400 | 16,100 | 53.8 | 81.7 | 11,700 | 11,600 | 11,500 | 11,400 | 85 |
| 90 | 45.5 | 80.7 | 17,200 | | 16,700 | | 16,200 | 15,700 | 49.8 | 75.9 | 11,400 | 11,300 | 11,200 | 11,200 | 90 |
| 95 | 41.4 | 74.5 | 16,000 | | 15,500 | | 15,100 | 14,600 | 45.5 | 69.2 | 11,100 | 11,000 | 11,000 | 10,900 | 95 |
| 100 | 37.0 | 67.2 | 14,900 | | 14,500 | | 14,100 | 13,700 | 40.6 | 61.2 | 10,900 | 10,800 | 10,800 | 10,800 | 100 |
| 105 | 31.8 | 58.4 | 13,800 | | 13,500 | | 13,200 | 12,800 | 34.8 | 51.3 | 10,700 | 10,700 | 10,700 | 10,700 | 105 |
| 110 | 25.6 | 47.2 | 12,900 | | 12,600 | | 12,300 | 12,100 | | | | | | | 110 |

MLC90A-1 S-2

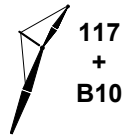

73,000 lb
+
23,100 lb

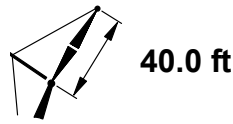
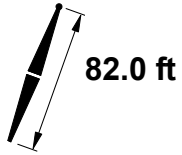

| | 10° | | | | | | | 30° | | | | | | |
|-----|------|-------|--------|--------|--------|--------|------|-------|--------|--------|--------|--------|----|-----|
| | | | | | | | | | | | | | | |
| | | | | | | | | | | | | | | |
| | | | | | | | | | | | | | | |
| ft | ° | ft | lb | lb | lb | lb | ° | ft | lb | lb | lb | lb | ft | |
| 34 | 80.4 | 126.0 | 26,200 | | | | | | | | | | | 34 |
| 36 | 79.5 | 125.5 | 26,100 | 22,800 | | | | | | | | | | 36 |
| 38 | 78.5 | 124.9 | 25,800 | 22,700 | 19,900 | | | | | | | | | 38 |
| 40 | 77.5 | 124.4 | 25,600 | 22,500 | 19,800 | 17,700 | | | | | | | | 40 |
| 42 | 76.6 | 123.7 | 25,500 | 22,400 | 19,700 | 17,500 | | | | | | | | 42 |
| 44 | 75.6 | 123.1 | 25,300 | 22,300 | 19,500 | 17,500 | 80.8 | 119.7 | 16,600 | | | | | 44 |
| 46 | 74.6 | 122.4 | 25,100 | 22,100 | 19,400 | 17,400 | 79.8 | 119.0 | 16,300 | 16,000 | | | | 46 |
| 48 | 73.6 | 121.6 | 24,900 | 22,000 | 19,300 | 17,300 | 78.7 | 118.2 | 16,000 | 15,700 | 15,400 | | | 48 |
| 50 | 72.6 | 120.9 | 24,700 | 21,800 | 19,200 | 17,300 | 77.7 | 117.4 | 15,700 | 15,400 | 15,200 | 12,800 | | 50 |
| 55 | 70.0 | 118.7 | 24,400 | 21,600 | 19,000 | 17,100 | 75.1 | 115.2 | 15,000 | 14,800 | 14,500 | 12,800 | | 55 |
| 60 | 67.5 | 116.4 | 24,000 | 21,300 | 18,800 | 16,900 | 72.4 | 112.7 | 14,400 | 14,200 | 14,000 | 12,800 | | 60 |
| 65 | 64.8 | 113.7 | 23,600 | 21,000 | 18,600 | 16,700 | 69.7 | 110.0 | 13,800 | 13,600 | 13,400 | 12,800 | | 65 |
| 70 | 62.1 | 110.7 | 23,300 | 20,800 | 18,400 | 16,500 | 66.8 | 106.9 | 13,300 | 13,100 | 13,000 | 12,800 | | 70 |
| 75 | 59.3 | 107.4 | 21,800 | 20,600 | 18,300 | 16,400 | 63.9 | 103.4 | 12,800 | 12,700 | 12,600 | 12,400 | | 75 |
| 80 | 56.4 | 103.7 | 20,000 | 19,200 | 18,100 | 16,400 | 60.9 | 99.6 | 12,400 | 12,300 | 12,200 | 12,100 | | 80 |
| 85 | 53.3 | 99.6 | 18,400 | 17,700 | 17,000 | 16,200 | 57.7 | 95.3 | 12,100 | 11,900 | 11,800 | 11,700 | | 85 |
| 90 | 50.2 | 95.0 | 17,000 | 16,400 | 15,800 | 15,200 | 54.4 | 90.4 | 11,700 | 11,600 | 11,500 | 11,500 | | 90 |
| 95 | 46.8 | 89.8 | 15,700 | 15,200 | 14,700 | 14,200 | 50.8 | 85.0 | 11,400 | 11,300 | 11,300 | 11,200 | | 95 |
| 100 | 43.2 | 84.0 | 14,600 | 14,100 | 13,700 | 13,300 | 47.0 | 78.8 | 11,200 | 11,100 | 11,000 | 11,000 | | 100 |
| 105 | 39.4 | 77.4 | 13,600 | 13,200 | 12,800 | 12,400 | 42.8 | 71.6 | 10,900 | 10,900 | 10,900 | 10,800 | | 105 |
| 110 | 35.1 | 69.7 | 12,700 | 12,300 | 12,000 | 11,700 | 38.1 | 63.1 | 10,800 | 10,700 | 10,700 | 10,700 | | 110 |
| 115 | 30.1 | 60.4 | 11,800 | 11,500 | 11,200 | 10,900 | 32.5 | 52.5 | 10,700 | 10,700 | 10,700 | 10,700 | | 115 |
| 120 | 24.1 | 48.5 | 11,100 | 10,800 | 10,600 | 10,300 | | | | | | | | 120 |

MLC90A-1 S-2

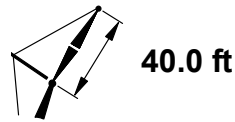
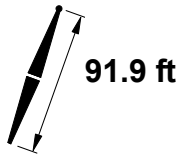
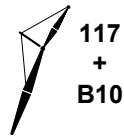

| | 10° | | | | | | | 30° | | | | | | |
|-----|------|-------|--------|----------|----------|----------|----------|-------|--------|----------|----------|----------|----------|-----|
| | | | | | | | | | | | | | | |
| | ft | ° | ft | 0° lb | 1° lb | 2° lb | 3° lb | ° | ft | 0° lb | 1° lb | 2° lb | 3° lb | ft |
| 36 | 80.3 | 135.6 | 26,200 | | | | | | | | | | | 36 |
| 38 | 79.4 | 135.1 | 25,900 | 22,700 | | | | | | | | | | 38 |
| 40 | 78.5 | 134.6 | 25,800 | 22,600 | 19,800 | | | | | | | | | 40 |
| 42 | 77.6 | 134.0 | 25,600 | 22,500 | 19,700 | 17,500 | | | | | | | | 42 |
| 44 | 76.7 | 133.4 | 25,400 | 22,300 | 19,600 | 17,500 | | | | | | | | 44 |
| 46 | 75.8 | 132.8 | 25,300 | 22,200 | 19,500 | 17,400 | 80.6 | 129.3 | 16,500 | | | | | 46 |
| 48 | 74.9 | 132.1 | 25,100 | 22,100 | 19,400 | 17,300 | 79.6 | 128.6 | 16,200 | 15,900 | | | | 48 |
| 50 | 73.9 | 131.4 | 25,000 | 22,000 | 19,300 | 17,300 | 78.7 | 127.8 | 16,000 | 15,700 | 15,200 | | | 50 |
| 55 | 71.6 | 129.4 | 24,600 | 21,700 | 19,100 | 17,100 | 76.3 | 125.8 | 15,300 | 15,000 | 14,800 | 12,500 | | 55 |
| 60 | 69.3 | 127.3 | 24,300 | 21,400 | 18,900 | 17,000 | 73.9 | 123.6 | 14,700 | 14,500 | 14,200 | 12,500 | | 60 |
| 65 | 66.9 | 124.8 | 23,900 | 21,200 | 18,700 | 16,800 | 71.4 | 121.1 | 14,100 | 13,900 | 13,800 | 12,500 | | 65 |
| 70 | 64.4 | 122.1 | 23,700 | 21,000 | 18,500 | 16,700 | 68.8 | 118.3 | 13,700 | 13,500 | 13,300 | 12,500 | | 70 |
| 75 | 61.9 | 119.1 | 21,700 | 20,700 | 18,400 | 16,500 | 66.2 | 115.2 | 13,200 | 13,000 | 12,900 | 12,500 | | 75 |
| 80 | 59.3 | 115.8 | 19,800 | 19,000 | 18,100 | 16,400 | 63.5 | 111.8 | 12,800 | 12,600 | 12,500 | 12,400 | | 80 |
| 85 | 56.6 | 112.2 | 18,200 | 17,500 | 16,800 | 16,100 | 60.8 | 108.0 | 12,400 | 12,300 | 12,200 | 12,100 | | 85 |
| 90 | 53.8 | 108.2 | 16,800 | 16,200 | 15,500 | 14,900 | 57.9 | 103.8 | 12,100 | 12,000 | 11,900 | 11,800 | | 90 |
| 95 | 51.0 | 103.8 | 15,600 | 15,000 | 14,400 | 13,900 | 54.8 | 99.2 | 11,800 | 11,700 | 11,600 | 11,500 | | 95 |
| 100 | 47.9 | 98.8 | 14,500 | 13,900 | 13,400 | 13,000 | 51.6 | 94.0 | 11,500 | 11,400 | 11,300 | 11,300 | | 100 |
| 105 | 44.7 | 93.4 | 13,400 | 13,000 | 12,600 | 12,100 | 48.2 | 88.2 | 11,200 | 11,200 | 11,100 | 11,100 | | 105 |
| 110 | 41.3 | 87.2 | 12,500 | 12,100 | 11,700 | 11,400 | 44.6 | 81.6 | 11,000 | 11,000 | 10,900 | 10,900 | | 110 |
| 115 | 37.5 | 80.1 | 11,700 | 11,300 | 11,000 | 10,700 | 40.5 | 73.9 | 10,800 | 10,800 | 10,800 | 10,800 | | 115 |
| 120 | 33.4 | 72.0 | 10,900 | 10,600 | 10,300 | 10,000 | 35.9 | 64.9 | 10,700 | 10,700 | 10,400 | 10,100 | | 120 |
| 125 | 28.6 | 62.2 | 10,200 | 10,000 | 9,700 | 9,400 | | | | | | | | 125 |
| 130 | 22.8 | 49.6 | 9,600 | 9,300 | 9,100 | 8,900 | | | | | | | | 130 |

MLC90A-1 S-2

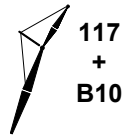

73,000 lb
+
23,100 lb

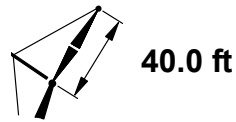
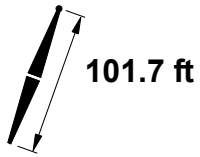

| | 10° | | | | | | | 30° | | | | | | |
|-----|------|-------|--------|----------|----------|----------|----------|-------|--------|----------|----------|----------|----------|-----|
| | | | | | | | | | | | | | | |
| | ft | ° | ft | 0° lb | 1° lb | 2° lb | 3° lb | ° | ft | 0° lb | 1° lb | 2° lb | 3° lb | ft |
| 36 | 81.0 | 145.7 | 26,100 | | | | | | | | | | | 36 |
| 38 | 80.1 | 145.2 | 26,000 | | | | | | | | | | | 38 |
| 40 | 79.3 | 144.7 | 25,800 | 22,600 | | | | | | | | | | 40 |
| 42 | 78.5 | 144.2 | 25,700 | 22,500 | 19,700 | | | | | | | | | 42 |
| 44 | 77.6 | 143.7 | 25,500 | 22,400 | 19,600 | 17,500 | | | | | | | | 44 |
| 46 | 76.8 | 143.1 | 25,400 | 22,200 | 19,500 | 17,400 | | | | | | | | 46 |
| 48 | 76.0 | 142.4 | 25,200 | 22,200 | 19,400 | 17,300 | 80.4 | 138.8 | 16,500 | | | | | 48 |
| 50 | 75.1 | 141.8 | 25,100 | 22,100 | 19,300 | 17,300 | 79.5 | 138.2 | 16,200 | 15,900 | | | | 50 |
| 55 | 73.0 | 140.0 | 24,800 | 21,800 | 19,200 | 17,100 | 77.3 | 136.3 | 15,600 | 15,300 | 14,700 | 12,200 | | 55 |
| 60 | 70.8 | 138.0 | 24,500 | 21,600 | 19,000 | 17,000 | 75.1 | 134.3 | 15,000 | 14,700 | 14,500 | 12,200 | | 60 |
| 65 | 68.6 | 135.8 | 24,200 | 21,400 | 18,800 | 16,800 | 72.8 | 132.0 | 14,500 | 14,200 | 14,000 | 12,200 | | 65 |
| 70 | 66.3 | 133.3 | 23,500 | 21,200 | 18,700 | 16,700 | 70.5 | 129.4 | 14,000 | 13,800 | 13,600 | 12,200 | | 70 |
| 75 | 64.1 | 130.6 | 21,400 | 20,300 | 18,600 | 16,600 | 68.2 | 126.6 | 13,500 | 13,300 | 13,200 | 12,200 | | 75 |
| 80 | 61.7 | 127.6 | 19,600 | 18,600 | 17,800 | 16,500 | 65.7 | 123.5 | 13,100 | 13,000 | 12,800 | 12,200 | | 80 |
| 85 | 59.3 | 124.3 | 18,000 | 17,200 | 16,400 | 15,700 | 63.2 | 120.2 | 12,700 | 12,600 | 12,500 | 12,200 | | 85 |
| 90 | 56.8 | 120.7 | 16,600 | 15,900 | 15,200 | 14,500 | 60.7 | 116.4 | 12,400 | 12,300 | 12,100 | 12,000 | | 90 |
| 95 | 54.3 | 116.8 | 15,300 | 14,700 | 14,100 | 13,500 | 58.0 | 112.3 | 12,100 | 12,000 | 11,900 | 11,800 | | 95 |
| 100 | 51.6 | 112.5 | 14,200 | 13,600 | 13,100 | 12,600 | 55.2 | 107.8 | 11,800 | 11,700 | 11,600 | 11,500 | | 100 |
| 105 | 48.8 | 107.8 | 13,200 | 12,700 | 12,200 | 11,700 | 52.3 | 102.9 | 11,500 | 11,400 | 11,400 | 11,300 | | 105 |
| 110 | 45.9 | 102.5 | 12,300 | 11,800 | 11,400 | 11,000 | 49.2 | 97.3 | 11,300 | 11,200 | 11,200 | 11,100 | | 110 |
| 115 | 42.8 | 96.7 | 11,400 | 11,000 | 10,700 | 10,300 | 46.0 | 91.2 | 11,100 | 11,000 | 10,900 | 10,500 | | 115 |
| 120 | 39.5 | 90.2 | 10,700 | 10,300 | 10,000 | 9,700 | 42.4 | 84.2 | 10,800 | 10,500 | 10,200 | 9,800 | | 120 |
| 125 | 35.9 | 82.8 | 10,000 | 9,700 | 9,400 | 9,100 | 38.5 | 76.1 | 10,100 | 9,800 | 9,500 | 9,200 | | 125 |
| 130 | 31.9 | 74.2 | 9,300 | 9,100 | 8,800 | 8,500 | 34.1 | 66.6 | 9,400 | 9,100 | 8,900 | 8,600 | | 130 |
| 135 | 27.3 | 63.9 | 8,700 | 8,500 | 8,300 | 8,000 | | | | | | | | 135 |
| 140 | 21.6 | 50.7 | 8,200 | 8,000 | 7,800 | 7,600 | | | | | | | | 140 |

MLC90A-1 S-2

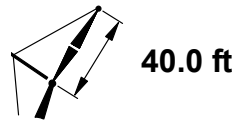
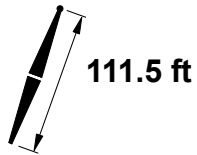
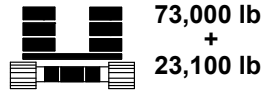
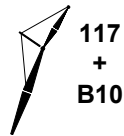

| | 10° | | | | | | | 30° | | | | | | |
|-----|------|-------|--------|----------|----------|----------|----------|-------|--------|----------|----------|----------|----------|-----|
| | | | | | | | | | | | | | | |
| | ft | ° | ft | 0° lb | 1° lb | 2° lb | 3° lb | ° | ft | 0° lb | 1° lb | 2° lb | 3° lb | ft |
| 38 | 80.8 | 155.3 | 26,000 | | | | | | | | | | | 38 |
| 40 | 80.0 | 154.9 | 25,900 | | | | | | | | | | | 40 |
| 42 | 79.2 | 154.4 | 25,700 | 22,400 | | | | | | | | | | 42 |
| 44 | 78.5 | 153.8 | 25,600 | 22,400 | 19,500 | | | | | | | | | 44 |
| 46 | 77.7 | 153.3 | 25,500 | 22,200 | 19,500 | 17,300 | | | | | | | | 46 |
| 48 | 76.9 | 152.7 | 25,300 | 22,200 | 19,400 | 17,300 | | | | | | | | 48 |
| 50 | 76.1 | 152.1 | 25,200 | 22,000 | 19,400 | 17,200 | 80.3 | 148.4 | 16,400 | | | | | 50 |
| 55 | 74.1 | 150.4 | 24,900 | 21,900 | 19,200 | 17,100 | 78.2 | 146.7 | 15,800 | 15,500 | 14,400 | | | 55 |
| 60 | 72.1 | 148.6 | 24,600 | 21,600 | 19,000 | 17,000 | 76.2 | 144.8 | 15,200 | 15,000 | 14,400 | 12,000 | | 60 |
| 65 | 70.1 | 146.5 | 24,400 | 21,500 | 18,900 | 16,900 | 74.1 | 142.7 | 14,700 | 14,500 | 14,300 | 12,000 | | 65 |
| 70 | 68.0 | 144.3 | 23,300 | 21,200 | 18,700 | 16,800 | 71.9 | 140.4 | 14,300 | 14,000 | 13,800 | 12,000 | | 70 |
| 75 | 65.9 | 141.8 | 21,200 | 20,000 | 18,600 | 16,700 | 69.8 | 137.8 | 13,800 | 13,600 | 13,400 | 12,000 | | 75 |
| 80 | 63.8 | 139.0 | 19,400 | 18,400 | 17,400 | 16,500 | 67.6 | 135.0 | 13,400 | 13,200 | 13,100 | 12,000 | | 80 |
| 85 | 61.6 | 136.1 | 17,800 | 16,900 | 16,100 | 15,300 | 65.3 | 131.9 | 13,000 | 12,900 | 12,700 | 12,000 | | 85 |
| 90 | 59.3 | 132.8 | 16,300 | 15,600 | 14,800 | 14,200 | 63.0 | 128.5 | 12,700 | 12,600 | 12,400 | 12,000 | | 90 |
| 95 | 57.0 | 129.3 | 15,100 | 14,400 | 13,800 | 13,100 | 60.6 | 124.9 | 12,400 | 12,200 | 12,100 | 12,000 | | 95 |
| 100 | 54.6 | 125.4 | 14,000 | 13,400 | 12,800 | 12,200 | 58.1 | 120.9 | 12,100 | 12,000 | 11,900 | 11,800 | | 100 |
| 105 | 52.2 | 121.2 | 13,000 | 12,400 | 11,900 | 11,400 | 55.5 | 116.5 | 11,800 | 11,700 | 11,600 | 11,500 | | 105 |
| 110 | 49.6 | 116.6 | 12,100 | 11,600 | 11,100 | 10,700 | 52.9 | 111.7 | 11,600 | 11,500 | 11,400 | 10,900 | | 110 |
| 115 | 46.9 | 111.6 | 11,200 | 10,800 | 10,400 | 10,000 | 50.1 | 106.4 | 11,300 | 11,000 | 10,600 | 10,200 | | 115 |
| 120 | 44.1 | 106.0 | 10,500 | 10,100 | 9,700 | 9,300 | 47.1 | 100.6 | 10,700 | 10,300 | 9,900 | 9,500 | | 120 |
| 125 | 41.1 | 99.9 | 9,800 | 9,400 | 9,100 | 8,700 | 43.9 | 94.0 | 9,900 | 9,600 | 9,300 | 8,900 | | 125 |
| 130 | 37.9 | 93.0 | 9,100 | 8,800 | 8,500 | 8,200 | 40.5 | 86.7 | 9,300 | 9,000 | 8,600 | 8,400 | | 130 |
| 135 | 34.5 | 85.3 | 8,500 | 8,300 | 8,000 | 7,700 | 36.7 | 78.2 | 8,600 | 8,400 | 8,100 | 7,800 | | 135 |
| 140 | 30.6 | 76.3 | 8,000 | 7,700 | 7,500 | 7,200 | 32.4 | 68.2 | 8,000 | 7,800 | 7,600 | 7,300 | | 140 |
| 145 | 26.1 | 65.5 | 7,500 | 7,200 | 7,000 | 6,800 | | | | | | | | 145 |
| 150 | 20.6 | 51.6 | 6,800 | 6,700 | 6,600 | 6,400 | | | | | | | | 150 |

MLC90A-1 S-2



73,000 lb
+
23,100 lb

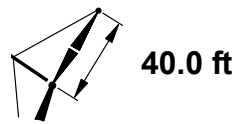
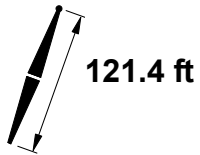

| | 10° | | | | | | | 30° | | | | | | |
|-----|------|-------|-----------------------|----------|----------|----------|----------|-------|-----------------------|----------|----------|----------|----------|-----|
| | | | 73,000 lb + 23,100 lb | | | | | | 73,000 lb + 23,100 lb | | | | | |
| | ft | ° | ft | 0° lb | 1° lb | 2° lb | 3° lb | ° | ft | 0° lb | 1° lb | 2° lb | 3° lb | ft |
| 40 | 80.6 | 164.9 | 25,900 | | | | | | | | | | | 40 |
| 42 | 79.9 | 164.5 | 25,700 | 22,400 | | | | | | | | | | 42 |
| 44 | 79.2 | 164.0 | 25,600 | 22,300 | | | | | | | | | | 44 |
| 46 | 78.5 | 163.5 | 25,500 | 22,200 | 19,400 | | | | | | | | | 46 |
| 48 | 77.7 | 162.9 | 25,400 | 22,200 | 19,300 | 17,200 | | | | | | | | 48 |
| 50 | 77.0 | 162.4 | 25,300 | 22,100 | 19,200 | 17,200 | 80.9 | 158.6 | 16,600 | | | | | 50 |
| 55 | 75.1 | 160.8 | 25,000 | 21,800 | 19,100 | 17,000 | 79.0 | 157.0 | 16,000 | 15,700 | 14,100 | | | 55 |
| 60 | 73.3 | 159.1 | 24,800 | 21,600 | 19,000 | 16,900 | 77.1 | 155.3 | 15,500 | 15,200 | 14,100 | 11,700 | | 60 |
| 65 | 71.4 | 157.2 | 24,500 | 21,500 | 18,900 | 16,800 | 75.1 | 153.3 | 15,000 | 14,700 | 14,100 | 11,700 | | 65 |
| 70 | 69.4 | 155.1 | 23,100 | 21,300 | 18,700 | 16,700 | 73.2 | 151.1 | 14,500 | 14,300 | 14,000 | 11,700 | | 70 |
| 75 | 67.5 | 152.8 | 20,900 | 19,700 | 18,600 | 16,700 | 71.2 | 148.8 | 14,100 | 13,900 | 13,700 | 11,700 | | 75 |
| 80 | 65.5 | 150.2 | 19,100 | 18,000 | 17,000 | 16,100 | 69.1 | 146.2 | 13,700 | 13,500 | 13,300 | 11,700 | | 80 |
| 85 | 63.5 | 147.5 | 17,500 | 16,600 | 15,700 | 14,900 | 67.0 | 143.4 | 13,300 | 13,100 | 13,000 | 11,700 | | 85 |
| 90 | 61.4 | 144.5 | 16,100 | 15,300 | 14,500 | 13,800 | 64.9 | 140.3 | 13,000 | 12,800 | 12,700 | 11,700 | | 90 |
| 95 | 59.3 | 141.3 | 14,800 | 14,100 | 13,400 | 12,800 | 62.7 | 136.9 | 12,700 | 12,500 | 12,400 | 11,700 | | 95 |
| 100 | 57.2 | 137.8 | 13,700 | 13,100 | 12,400 | 11,900 | 60.5 | 133.3 | 12,400 | 12,200 | 12,100 | 11,700 | | 100 |
| 105 | 54.9 | 134.0 | 12,700 | 12,100 | 11,600 | 11,000 | 58.2 | 129.4 | 12,100 | 12,000 | 11,900 | 11,400 | | 105 |
| 110 | 52.7 | 129.9 | 11,800 | 11,300 | 10,800 | 10,300 | 55.8 | 125.1 | 11,800 | 11,600 | 11,100 | 10,600 | | 110 |
| 115 | 50.3 | 125.4 | 11,000 | 10,500 | 10,000 | 9,600 | 53.3 | 120.5 | 11,300 | 10,800 | 10,300 | 9,900 | | 115 |
| 120 | 47.8 | 120.5 | 10,200 | 9,800 | 9,400 | 9,000 | 50.8 | 115.4 | 10,500 | 10,000 | 9,600 | 9,200 | | 120 |
| 125 | 45.2 | 115.2 | 9,500 | 9,100 | 8,800 | 8,400 | 48.1 | 109.8 | 9,700 | 9,300 | 9,000 | 8,600 | | 125 |
| 130 | 42.5 | 109.4 | 8,900 | 8,500 | 8,200 | 7,900 | 45.2 | 103.6 | 9,100 | 8,700 | 8,400 | 8,000 | | 130 |
| 135 | 39.6 | 103.0 | 8,300 | 8,000 | 7,700 | 7,400 | 42.1 | 96.8 | 8,400 | 8,100 | 7,800 | 7,500 | | 135 |
| 140 | 36.5 | 95.8 | 7,700 | 7,400 | 7,200 | 6,900 | 38.8 | 89.1 | 7,800 | 7,600 | 7,300 | 7,000 | | 140 |
| 145 | 33.1 | 87.6 | 7,200 | 7,000 | 6,700 | 6,500 | 35.1 | 80.2 | 7,300 | 7,000 | 6,800 | 6,600 | | 145 |
| 150 | 29.4 | 78.2 | 6,700 | 6,500 | 6,300 | 6,100 | | | | | | | | 150 |
| 155 | 25.0 | 67.0 | 6,300 | 6,100 | 5,900 | 5,700 | | | | | | | | 155 |

MLC90A-1 S-2

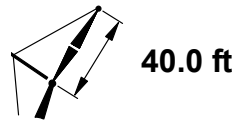
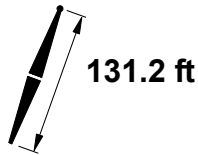
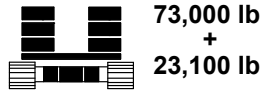
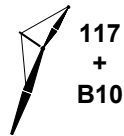

| | 10° | | | | | | | 30° | | | | | | | |
|-----|------|-------|--------|----------|----------|----------|----------|-------|--------|--------|----------|----------|----------|----------|-----|
| | | | | | | | | | | | | | | | |
| | ft | ° | ft | 0° lb | 1° lb | 2° lb | 3° lb | ft | ° | ft | 0° lb | 1° lb | 2° lb | 3° lb | ft |
| 42 | 80.5 | 174.6 | 25,700 | | | | | | | | | | | | 42 |
| 44 | 79.8 | 174.1 | 25,600 | 22,200 | | | | | | | | | | | 44 |
| 46 | 79.1 | 173.6 | 25,400 | 22,100 | | | | | | | | | | | 46 |
| 48 | 78.4 | 173.1 | 25,400 | 22,100 | 19,300 | | | | | | | | | | 48 |
| 50 | 77.8 | 172.6 | 25,200 | 22,000 | 19,200 | 17,100 | | | | | | | | | 50 |
| 55 | 76.0 | 171.1 | 25,000 | 21,800 | 19,100 | 16,900 | 79.7 | 167.3 | 16,200 | 15,900 | | | | | 55 |
| 60 | 74.3 | 169.5 | 24,800 | 21,600 | 18,900 | 16,900 | 77.9 | 165.7 | 15,700 | 15,400 | 13,800 | 11,500 | | | 60 |
| 65 | 72.5 | 167.7 | 24,500 | 21,500 | 18,800 | 16,800 | 76.1 | 163.8 | 15,200 | 15,000 | 13,800 | 11,500 | | | 65 |
| 70 | 70.7 | 165.8 | 22,800 | 21,300 | 18,700 | 16,700 | 74.2 | 161.8 | 14,800 | 14,500 | 13,700 | 11,500 | | | 70 |
| 75 | 68.9 | 163.6 | 20,700 | 19,400 | 18,300 | 16,600 | 72.4 | 159.6 | 14,300 | 14,100 | 13,700 | 11,500 | | | 75 |
| 80 | 67.0 | 161.3 | 18,900 | 17,800 | 16,700 | 15,800 | 70.5 | 157.2 | 13,900 | 13,700 | 13,600 | 11,500 | | | 80 |
| 85 | 65.2 | 158.7 | 17,300 | 16,300 | 15,400 | 14,500 | 68.5 | 154.6 | 13,600 | 13,400 | 13,200 | 11,500 | | | 85 |
| 90 | 63.3 | 156.0 | 15,900 | 15,000 | 14,200 | 13,400 | 66.6 | 151.7 | 13,200 | 13,100 | 12,900 | 11,500 | | | 90 |
| 95 | 61.3 | 153.0 | 14,600 | 13,900 | 13,100 | 12,400 | 64.6 | 148.7 | 12,900 | 12,800 | 12,600 | 11,500 | | | 95 |
| 100 | 59.3 | 149.8 | 13,500 | 12,800 | 12,200 | 11,500 | 62.5 | 145.4 | 12,600 | 12,500 | 12,400 | 11,500 | | | 100 |
| 105 | 57.3 | 146.3 | 12,500 | 11,900 | 11,300 | 10,700 | 60.4 | 141.8 | 12,300 | 12,200 | 11,700 | 11,100 | | | 105 |
| 110 | 55.2 | 142.6 | 11,600 | 11,000 | 10,500 | 10,000 | 58.3 | 137.9 | 12,000 | 11,400 | 10,900 | 10,300 | | | 110 |
| 115 | 53.1 | 138.5 | 10,800 | 10,300 | 9,800 | 9,300 | 56.1 | 133.7 | 11,100 | 10,600 | 10,100 | 9,600 | | | 115 |
| 120 | 50.9 | 134.2 | 10,000 | 9,600 | 9,100 | 8,700 | 53.8 | 129.2 | 10,300 | 9,800 | 9,400 | 9,000 | | | 120 |
| 125 | 48.6 | 129.4 | 9,300 | 8,900 | 8,500 | 8,100 | 51.4 | 124.3 | 9,600 | 9,200 | 8,800 | 8,400 | | | 125 |
| 130 | 46.2 | 124.3 | 8,700 | 8,300 | 7,900 | 7,600 | 48.9 | 118.9 | 8,900 | 8,500 | 8,200 | 7,800 | | | 130 |
| 135 | 43.7 | 118.7 | 8,100 | 7,800 | 7,400 | 7,100 | 46.2 | 113.0 | 8,300 | 7,900 | 7,600 | 7,300 | | | 135 |
| 140 | 41.0 | 112.6 | 7,600 | 7,200 | 6,900 | 6,600 | 43.5 | 106.6 | 7,700 | 7,400 | 7,100 | 6,800 | | | 140 |
| 145 | 38.2 | 105.9 | 7,000 | 6,800 | 6,500 | 6,200 | 40.5 | 99.4 | 7,200 | 6,900 | 6,600 | 6,300 | | | 145 |
| 150 | 35.2 | 98.4 | 6,600 | 6,300 | 6,100 | 5,800 | 37.2 | 91.3 | 6,700 | 6,400 | 6,200 | 5,900 | | | 150 |
| 155 | 32.0 | 89.9 | 6,100 | 5,900 | 5,700 | 5,400 | 33.6 | 82.1 | 6,200 | 6,000 | 5,700 | 5,500 | | | 155 |
| 160 | 28.3 | 80.1 | 5,700 | 5,500 | 5,300 | 5,100 | | | | | | | | | 160 |
| 165 | 24.0 | 68.4 | 5,300 | 5,100 | 4,900 | 4,800 | | | | | | | | | 165 |

MLC90A-1 S-2



73,000 lb
+
23,100 lb

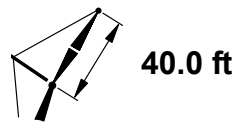
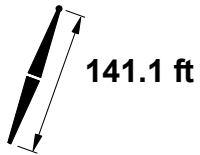

| | | 10° | | | | | | 30° | | | | | | | |
|-----|------|-------|--------|--------|--------|--------|------|-------|--------|--------|--------|--------|--|-----|--|
| | | | | | | | | | | | | | | | |
| | | | | | | | | | | | | | | | |
| | | 0° | | | | 1° | | 0° | | | | 1° | | | |
| | | 2° | | | | 3° | | 2° | | | | 3° | | | |
| | | lb | | | | lb | | lb | | | | lb | | | |
| | | ft | | ° | | ft | | ° | | ft | | ° | | | |
| 44 | 80.4 | 184.2 | 25,500 | | | | | | | | | | | 44 | |
| 46 | 79.7 | 183.7 | 25,400 | 22,000 | | | | | | | | | | 46 | |
| 48 | 79.1 | 183.3 | 25,300 | 21,900 | | | | | | | | | | 48 | |
| 50 | 78.4 | 182.8 | 25,200 | 21,900 | 19,000 | | | | | | | | | 50 | |
| 55 | 76.8 | 181.4 | 25,000 | 21,700 | 19,000 | 16,800 | 80.3 | 177.5 | 16,400 | | | | | 55 | |
| 60 | 75.1 | 179.9 | 24,800 | 21,600 | 18,900 | 16,800 | 78.6 | 176.0 | 15,900 | 15,600 | 13,600 | | | 60 | |
| 65 | 73.5 | 178.2 | 24,600 | 21,400 | 18,800 | 16,700 | 76.9 | 174.2 | 15,400 | 15,200 | 13,500 | 11,300 | | 65 | |
| 70 | 71.8 | 176.3 | 22,600 | 21,000 | 18,600 | 16,600 | 75.1 | 172.4 | 15,000 | 14,700 | 13,500 | 11,300 | | 70 | |
| 75 | 70.1 | 174.3 | 20,500 | 19,100 | 17,900 | 16,500 | 73.4 | 170.3 | 14,600 | 14,300 | 13,400 | 11,300 | | 75 | |
| 80 | 68.4 | 172.1 | 18,600 | 17,500 | 16,400 | 15,400 | 71.6 | 168.0 | 14,200 | 14,000 | 13,400 | 11,300 | | 80 | |
| 85 | 66.6 | 169.8 | 17,000 | 16,000 | 15,000 | 14,100 | 69.8 | 165.6 | 13,800 | 13,600 | 13,400 | 11,300 | | 85 | |
| 90 | 64.9 | 167.2 | 15,600 | 14,700 | 13,800 | 13,000 | 68.0 | 163.0 | 13,500 | 13,300 | 13,100 | 11,300 | | 90 | |
| 95 | 63.1 | 164.4 | 14,400 | 13,600 | 12,800 | 12,100 | 66.2 | 160.1 | 13,200 | 13,000 | 12,900 | 11,300 | | 95 | |
| 100 | 61.2 | 161.4 | 13,300 | 12,500 | 11,800 | 11,200 | 64.3 | 157.1 | 12,900 | 12,700 | 12,300 | 11,300 | | 100 | |
| 105 | 59.3 | 158.2 | 12,300 | 11,600 | 11,000 | 10,400 | 62.4 | 153.8 | 12,600 | 12,000 | 11,400 | 10,800 | | 105 | |
| 110 | 57.4 | 154.8 | 11,300 | 10,700 | 10,200 | 9,600 | 60.4 | 150.2 | 11,700 | 11,100 | 10,600 | 10,000 | | 110 | |
| 115 | 55.5 | 151.1 | 10,500 | 10,000 | 9,500 | 9,000 | 58.4 | 146.4 | 10,900 | 10,300 | 9,800 | 9,300 | | 115 | |
| 120 | 53.5 | 147.1 | 9,800 | 9,300 | 8,800 | 8,400 | 56.3 | 142.3 | 10,100 | 9,600 | 9,100 | 8,700 | | 120 | |
| 125 | 51.4 | 142.9 | 9,100 | 8,600 | 8,200 | 7,800 | 54.1 | 137.9 | 9,400 | 8,900 | 8,500 | 8,100 | | 125 | |
| 130 | 49.2 | 138.3 | 8,400 | 8,000 | 7,600 | 7,300 | 51.9 | 133.1 | 8,700 | 8,300 | 7,900 | 7,500 | | 130 | |
| 135 | 47.0 | 133.3 | 7,800 | 7,500 | 7,100 | 6,800 | 49.6 | 127.9 | 8,100 | 7,700 | 7,300 | 7,000 | | 135 | |
| 140 | 44.7 | 127.9 | 7,300 | 7,000 | 6,600 | 6,300 | 47.2 | 122.3 | 7,500 | 7,200 | 6,800 | 6,500 | | 140 | |
| 145 | 42.3 | 122.1 | 6,800 | 6,500 | 6,200 | 5,900 | 44.6 | 116.2 | 7,000 | 6,600 | 6,300 | 6,100 | | 145 | |
| 150 | 39.7 | 115.7 | 6,300 | 6,000 | 5,800 | 5,500 | 41.9 | 109.4 | 6,500 | 6,200 | 5,900 | 5,600 | | 150 | |
| 155 | 37.0 | 108.7 | 5,900 | 5,600 | 5,400 | 5,100 | 39.0 | 101.9 | 6,000 | 5,700 | 5,500 | 5,200 | | 155 | |
| 160 | 34.1 | 100.9 | 5,500 | 5,200 | 5,000 | 4,800 | 35.8 | 93.5 | 5,500 | 5,300 | 5,100 | 4,800 | | 160 | |
| 165 | 30.9 | 92.1 | 5,100 | 4,800 | 4,600 | 4,400 | 32.3 | 83.9 | 5,100 | 4,900 | 4,700 | 4,500 | | 165 | |
| 170 | 27.3 | 81.9 | 4,700 | 4,500 | 4,300 | 4,100 | | | | | | | | 170 | |
| 175 | 23.1 | 69.7 | 4,300 | 4,200 | 4,000 | 3,800 | | | | | | | | 175 | |

MLC90A-1 S-2

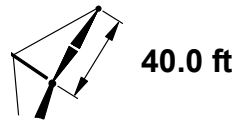
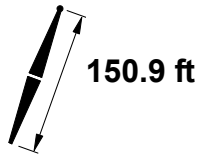
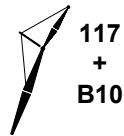

| | 10° | | | | | | | 30° | | | | | | | |
|-----|------|-------|--------|--------|--------|--------|------|-------|--------|--------|--------|--------|----|----|-----|
| | | | | | | | | | | | | | | | |
| | ft | ° | ft | 0° | 1° | 2° | 3° | ft | ° | ft | 0° | 1° | 2° | 3° | ft |
| 44 | 80.9 | 194.3 | 25,300 | | | | | | | | | | | | 44 |
| 46 | 80.3 | 193.8 | 25,200 | | | | | | | | | | | | 46 |
| 48 | 79.7 | 193.4 | 25,200 | 21,800 | | | | | | | | | | | 48 |
| 50 | 79.0 | 192.9 | 25,100 | 21,700 | | | | | | | | | | | 50 |
| 55 | 77.5 | 191.6 | 24,900 | 21,600 | 18,800 | 15,900 | | 80.8 | 187.7 | 16,600 | | | | | 55 |
| 60 | 75.9 | 190.2 | 24,700 | 21,400 | 18,700 | 15,900 | 79.2 | 186.2 | 16,100 | 15,800 | | | | | 60 |
| 65 | 74.4 | 188.6 | 24,500 | 21,300 | 18,600 | 15,800 | 77.6 | 184.6 | 15,600 | 15,300 | 13,300 | 11,100 | | | 65 |
| 70 | 72.8 | 186.8 | 22,400 | 20,700 | 18,500 | 15,800 | 76.0 | 182.8 | 15,200 | 14,900 | 13,200 | 11,100 | | | 70 |
| 75 | 71.2 | 184.9 | 20,200 | 18,800 | 17,500 | 15,800 | 74.3 | 180.9 | 14,800 | 14,500 | 13,200 | 11,100 | | | 75 |
| 80 | 69.6 | 182.9 | 18,400 | 17,200 | 16,000 | 15,000 | 72.7 | 178.8 | 14,400 | 14,200 | 13,200 | 11,100 | | | 80 |
| 85 | 67.9 | 180.7 | 16,800 | 15,700 | 14,700 | 13,800 | 71.0 | 176.5 | 14,000 | 13,800 | 13,100 | 11,100 | | | 85 |
| 90 | 66.3 | 178.3 | 15,400 | 14,400 | 13,500 | 12,700 | 69.3 | 174.0 | 13,700 | 13,500 | 13,100 | 11,100 | | | 90 |
| 95 | 64.6 | 175.7 | 14,100 | 13,300 | 12,500 | 11,700 | 67.6 | 171.4 | 13,400 | 13,200 | 13,000 | 11,100 | | | 95 |
| 100 | 62.9 | 172.9 | 13,000 | 12,200 | 11,500 | 10,800 | 65.8 | 168.5 | 13,100 | 12,800 | 12,000 | 11,100 | | | 100 |
| 105 | 61.1 | 169.9 | 12,000 | 11,300 | 10,700 | 10,000 | 64.0 | 165.5 | 12,500 | 11,800 | 11,100 | 10,500 | | | 105 |
| 110 | 59.4 | 166.7 | 11,100 | 10,500 | 9,900 | 9,300 | 62.2 | 162.2 | 11,500 | 10,900 | 10,300 | 9,700 | | | 110 |
| 115 | 57.5 | 163.3 | 10,300 | 9,700 | 9,200 | 8,600 | 60.3 | 158.7 | 10,700 | 10,100 | 9,500 | 9,000 | | | 115 |
| 120 | 55.7 | 159.7 | 9,500 | 9,000 | 8,500 | 8,000 | 58.4 | 154.9 | 9,900 | 9,400 | 8,900 | 8,400 | | | 120 |
| 125 | 53.8 | 155.8 | 8,800 | 8,400 | 7,900 | 7,500 | 56.5 | 150.9 | 9,200 | 8,700 | 8,200 | 7,800 | | | 125 |
| 130 | 51.8 | 151.6 | 8,200 | 7,800 | 7,300 | 6,900 | 54.4 | 146.6 | 8,500 | 8,100 | 7,600 | 7,200 | | | 130 |
| 135 | 49.8 | 147.1 | 7,600 | 7,200 | 6,800 | 6,500 | 52.4 | 141.9 | 7,900 | 7,500 | 7,100 | 6,700 | | | 135 |
| 140 | 47.7 | 142.2 | 7,100 | 6,700 | 6,300 | 6,000 | 50.2 | 136.9 | 7,300 | 6,900 | 6,600 | 6,200 | | | 140 |
| 145 | 45.6 | 137.1 | 6,600 | 6,200 | 5,900 | 5,600 | 47.9 | 131.5 | 6,800 | 6,400 | 6,100 | 5,800 | | | 145 |
| 150 | 43.3 | 131.4 | 6,100 | 5,800 | 5,500 | 5,200 | 45.6 | 125.6 | 6,300 | 6,000 | 5,700 | 5,400 | | | 150 |
| 155 | 41.0 | 125.4 | 5,600 | 5,400 | 5,100 | 4,800 | 43.1 | 119.2 | 5,800 | 5,500 | 5,200 | 5,000 | | | 155 |
| 160 | 38.5 | 118.7 | 5,200 | 5,000 | 4,700 | 4,500 | 40.5 | 112.1 | 5,400 | 5,100 | 4,800 | 4,600 | | | 160 |
| 165 | 35.8 | 111.4 | 4,800 | 4,600 | 4,400 | 4,100 | 37.6 | 104.4 | 4,900 | 4,700 | 4,500 | 4,200 | | | 165 |
| 170 | 33.0 | 103.3 | 4,500 | 4,300 | 4,000 | 3,800 | 34.6 | 95.6 | 4,500 | 4,300 | 4,100 | 3,900 | | | 170 |
| 175 | 29.9 | 94.2 | 4,100 | 3,900 | 3,700 | 3,500 | 31.1 | 85.6 | 4,200 | 4,000 | 3,800 | 3,600 | | | 175 |
| 180 | 26.4 | 83.6 | 3,700 | 3,600 | 3,400 | 3,300 | | | | | | | | | 180 |
| 185 | 22.3 | 71.0 | 3,200 | 3,100 | 3,000 | 2,900 | | | | | | | | | 185 |

MLC90A-1 S-2



73,000 lb
+
23,100 lb

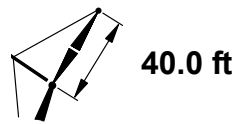
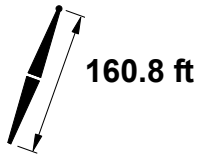

| | 10° | | | | | | | 30° | | | | | | | |
|-----|------|-------|-----------------------|----------|----------|----------|----------|------|-----------------------|--------|----------|----------|----------|----------|-----|
| | | | 73,000 lb + 23,100 lb | | | | | | 73,000 lb + 23,100 lb | | | | | | |
| | ft | ° | ft | 0° lb | 1° lb | 2° lb | 3° lb | ft | ° | ft | 0° lb | 1° lb | 2° lb | 3° lb | ft |
| 46 | 80.8 | 203.9 | 25,000 | | | | | | | | | | | | 46 |
| 48 | 80.2 | 203.4 | 25,000 | | | | | | | | | | | | 48 |
| 50 | 79.6 | 203.0 | 24,900 | 21,500 | | | | | | | | | | | 50 |
| 55 | 78.1 | 201.8 | 24,700 | 21,400 | 18,300 | | | | | | | | | | 55 |
| 60 | 76.6 | 200.4 | 24,600 | 21,200 | 18,200 | 14,100 | | 79.8 | 196.4 | 16,200 | 15,900 | | | | 60 |
| 65 | 75.2 | 198.9 | 24,400 | 21,100 | 18,200 | 14,100 | | 78.2 | 194.9 | 15,800 | 15,500 | 13,000 | | | 65 |
| 70 | 73.7 | 197.3 | 22,100 | 20,400 | 18,200 | 14,000 | | 76.7 | 193.2 | 15,400 | 15,100 | 12,900 | 10,900 | | 70 |
| 75 | 72.2 | 195.5 | 20,000 | 18,500 | 17,100 | 14,000 | | 75.2 | 191.4 | 15,000 | 14,700 | 12,900 | 10,900 | | 75 |
| 80 | 70.6 | 193.5 | 18,100 | 16,800 | 15,700 | 13,900 | | 73.6 | 189.4 | 14,600 | 14,400 | 12,900 | 10,900 | | 80 |
| 85 | 69.1 | 191.4 | 16,500 | 15,400 | 14,300 | 13,400 | | 72.0 | 187.3 | 14,200 | 14,000 | 12,900 | 10,900 | | 85 |
| 90 | 67.5 | 189.2 | 15,100 | 14,100 | 13,200 | 12,300 | | 70.4 | 185.0 | 13,900 | 13,700 | 12,900 | 10,900 | | 90 |
| 95 | 65.9 | 186.7 | 13,900 | 13,000 | 12,100 | 11,300 | | 68.8 | 182.5 | 13,600 | 13,400 | 12,700 | 10,900 | | 95 |
| 100 | 64.3 | 184.1 | 12,800 | 11,900 | 11,200 | 10,500 | | 67.2 | 179.8 | 13,300 | 12,500 | 11,700 | 10,900 | | 100 |
| 105 | 62.7 | 181.4 | 11,800 | 11,000 | 10,300 | 9,700 | | 65.5 | 177.0 | 12,300 | 11,500 | 10,800 | 10,200 | | 105 |
| 110 | 61.0 | 178.4 | 10,800 | 10,200 | 9,600 | 9,000 | | 63.8 | 173.9 | 11,300 | 10,600 | 10,000 | 9,400 | | 110 |
| 115 | 59.4 | 175.2 | 10,000 | 9,400 | 8,800 | 8,300 | | 62.1 | 170.6 | 10,500 | 9,800 | 9,300 | 8,700 | | 115 |
| 120 | 57.6 | 171.8 | 9,300 | 8,700 | 8,200 | 7,700 | | 60.3 | 167.2 | 9,700 | 9,100 | 8,600 | 8,100 | | 120 |
| 125 | 55.9 | 168.2 | 8,600 | 8,100 | 7,600 | 7,100 | | 58.5 | 163.4 | 8,900 | 8,400 | 7,900 | 7,500 | | 125 |
| 130 | 54.1 | 164.3 | 7,900 | 7,500 | 7,000 | 6,600 | | 56.6 | 159.5 | 8,300 | 7,800 | 7,400 | 6,900 | | 130 |
| 135 | 52.2 | 160.2 | 7,300 | 6,900 | 6,500 | 6,100 | | 54.7 | 155.2 | 7,600 | 7,200 | 6,800 | 6,400 | | 135 |
| 140 | 50.3 | 155.8 | 6,800 | 6,400 | 6,000 | 5,700 | | 52.8 | 150.6 | 7,100 | 6,700 | 6,300 | 5,900 | | 140 |
| 145 | 48.4 | 151.1 | 6,300 | 5,900 | 5,600 | 5,300 | | 50.7 | 145.8 | 6,500 | 6,200 | 5,800 | 5,500 | | 145 |
| 150 | 46.4 | 146.1 | 5,800 | 5,500 | 5,200 | 4,900 | | 48.6 | 140.5 | 6,000 | 5,700 | 5,400 | 5,100 | | 150 |
| 155 | 44.3 | 140.7 | 5,400 | 5,100 | 4,800 | 4,500 | | 46.4 | 134.9 | 5,600 | 5,300 | 5,000 | 4,700 | | 155 |
| 160 | 42.1 | 134.8 | 5,000 | 4,700 | 4,400 | 4,200 | | 44.1 | 128.7 | 5,100 | 4,900 | 4,600 | 4,300 | | 160 |
| 165 | 39.8 | 128.5 | 4,600 | 4,300 | 4,100 | 3,800 | | 41.7 | 122.1 | 4,700 | 4,500 | 4,200 | 4,000 | | 165 |
| 170 | 37.4 | 121.6 | 4,200 | 4,000 | 3,700 | 3,500 | | 39.2 | 114.8 | 4,300 | 4,100 | 3,900 | 3,600 | | 170 |
| 175 | 34.8 | 114.0 | 3,900 | 3,600 | 3,400 | 3,200 | | 36.4 | 106.7 | 4,000 | 3,700 | 3,500 | 3,300 | | 175 |
| 180 | 32.0 | 105.6 | 3,500 | 3,300 | 3,100 | 2,900 | | 33.4 | 97.6 | 3,600 | 3,400 | 3,200 | 3,000 | | 180 |
| 185 | 28.9 | 96.2 | 3,100 | 3,000 | 2,800 | 2,700 | | | | | | | | | 185 |
| 190 | 25.5 | 85.2 | 2,600 | 2,500 | 2,400 | 2,300 | | | | | | | | | 190 |
| 195 | 21.5 | 72.1 | 2,100 | 2,000 | 2,000 | | | | | | | | | | 195 |

MLC90A-1 S-2

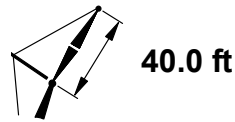
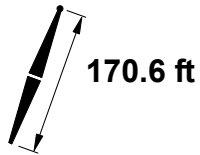
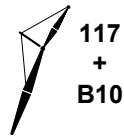

| | 10° | | | | | | | 30° | | | | | | | |
|-----|------|-------|--------|--------|--------|--------|------|-------|--------|--------|--------|--------|----|----|-----|
| | | | | | | | | | | | | | | | |
| | ft | ° | ft | 0° | 1° | 2° | 3° | ft | ° | ft | 0° | 1° | 2° | 3° | ft |
| 48 | 80.6 | 213.5 | 24,700 | | | | | | | | | | | | 48 |
| 50 | 80.1 | 213.1 | 24,700 | | | | | | | | | | | | 50 |
| 55 | 78.7 | 211.9 | 24,500 | 21,100 | 16,500 | | | | | | | | | | 55 |
| 60 | 77.3 | 210.6 | 24,400 | 21,000 | 16,400 | 12,600 | | 80.3 | 206.6 | 16,400 | | | | | 60 |
| 65 | 75.9 | 209.2 | 24,200 | 20,900 | 16,300 | 12,500 | | 78.8 | 205.2 | 16,000 | 15,500 | 12,700 | | | 65 |
| 70 | 74.5 | 207.6 | 21,900 | 20,100 | 16,300 | 12,500 | 77.4 | 203.6 | 15,500 | 15,300 | 12,600 | 10,400 | | | 70 |
| 75 | 73.0 | 205.9 | 19,800 | 18,200 | 16,200 | 12,400 | 75.9 | 201.8 | 15,200 | 14,900 | 12,600 | 10,400 | | | 75 |
| 80 | 71.6 | 204.1 | 17,900 | 16,600 | 15,300 | 12,400 | 74.4 | 200.0 | 14,800 | 14,600 | 12,600 | 10,400 | | | 80 |
| 85 | 70.1 | 202.1 | 16,300 | 15,100 | 14,000 | 12,400 | 72.9 | 197.9 | 14,400 | 14,200 | 12,600 | 10,400 | | | 85 |
| 90 | 68.6 | 200.0 | 14,900 | 13,800 | 12,900 | 12,000 | 71.4 | 195.8 | 14,100 | 13,900 | 12,600 | 10,400 | | | 90 |
| 95 | 67.1 | 197.7 | 13,700 | 12,700 | 11,800 | 11,000 | 69.9 | 193.4 | 13,800 | 13,300 | 12,400 | 10,400 | | | 95 |
| 100 | 65.6 | 195.2 | 12,500 | 11,700 | 10,900 | 10,200 | 68.4 | 190.9 | 13,100 | 12,300 | 11,500 | 10,400 | | | 100 |
| 105 | 64.1 | 192.6 | 11,500 | 10,800 | 10,100 | 9,400 | 66.8 | 188.2 | 12,100 | 11,300 | 10,600 | 9,900 | | | 105 |
| 110 | 62.5 | 189.8 | 10,600 | 9,900 | 9,300 | 8,700 | 65.2 | 185.4 | 11,100 | 10,400 | 9,800 | 9,100 | | | 110 |
| 115 | 61.0 | 186.9 | 9,800 | 9,200 | 8,600 | 8,000 | 63.6 | 182.3 | 10,300 | 9,600 | 9,000 | 8,400 | | | 115 |
| 120 | 59.4 | 183.7 | 9,000 | 8,500 | 7,900 | 7,400 | 61.9 | 179.1 | 9,500 | 8,900 | 8,300 | 7,800 | | | 120 |
| 125 | 57.7 | 180.3 | 8,400 | 7,800 | 7,300 | 6,900 | 60.2 | 175.6 | 8,800 | 8,200 | 7,700 | 7,200 | | | 125 |
| 130 | 56.1 | 176.7 | 7,700 | 7,200 | 6,800 | 6,300 | 58.5 | 171.9 | 8,100 | 7,600 | 7,100 | 6,700 | | | 130 |
| 135 | 54.4 | 172.9 | 7,100 | 6,700 | 6,300 | 5,900 | 56.8 | 168.0 | 7,500 | 7,000 | 6,600 | 6,200 | | | 135 |
| 140 | 52.6 | 168.9 | 6,600 | 6,200 | 5,800 | 5,400 | 55.0 | 163.8 | 6,900 | 6,500 | 6,100 | 5,700 | | | 140 |
| 145 | 50.8 | 164.6 | 6,100 | 5,700 | 5,300 | 5,000 | 53.1 | 159.4 | 6,400 | 6,000 | 5,600 | 5,300 | | | 145 |
| 150 | 49.0 | 160.0 | 5,600 | 5,300 | 4,900 | 4,600 | 51.2 | 154.6 | 5,900 | 5,500 | 5,200 | 4,800 | | | 150 |
| 155 | 47.1 | 155.1 | 5,200 | 4,900 | 4,500 | 4,200 | 49.2 | 149.5 | 5,400 | 5,100 | 4,800 | 4,400 | | | 155 |
| 160 | 45.1 | 149.8 | 4,800 | 4,500 | 4,200 | 3,900 | 47.2 | 144.0 | 5,000 | 4,700 | 4,400 | 4,100 | | | 160 |
| 165 | 43.0 | 144.2 | 4,400 | 4,100 | 3,800 | 3,600 | 45.0 | 138.2 | 4,600 | 4,300 | 4,000 | 3,700 | | | 165 |
| 170 | 40.9 | 138.1 | 4,000 | 3,800 | 3,500 | 3,300 | 42.8 | 131.8 | 4,200 | 3,900 | 3,700 | 3,400 | | | 170 |
| 175 | 38.7 | 131.5 | 3,700 | 3,400 | 3,200 | 3,000 | 40.5 | 124.9 | 3,800 | 3,600 | 3,300 | 3,100 | | | 175 |
| 180 | 36.3 | 124.4 | 3,300 | 3,100 | 2,900 | 2,700 | 37.9 | 117.3 | 3,400 | 3,200 | 3,000 | 2,800 | | | 180 |
| 185 | 33.8 | 116.5 | 3,000 | 2,800 | 2,600 | 2,400 | 35.2 | 108.9 | 3,100 | 2,900 | 2,700 | 2,500 | | | 185 |
| 190 | 31.1 | 107.9 | 2,500 | 2,400 | 2,300 | 2,200 | 32.3 | 99.5 | 2,600 | 2,500 | 2,400 | 2,200 | | | 190 |
| 195 | 28.1 | 98.1 | 2,100 | 2,000 | | | | | | | | | | | 195 |

MLC90A-1 S-2



73,000 lb
+
23,100 lb

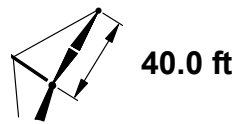
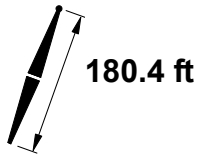

| | 10° | | | | | | | 30° | | | | | | |
|-----|------|-------|--------|----------|----------|----------|----------|------|-------|----------|----------|----------|----------|-----|
| | | | | | | | | | | | | | | |
| | ft | ° | ft | 0° lb | 1° lb | 2° lb | 3° lb | ° | ft | 0° lb | 1° lb | 2° lb | 3° lb | ft |
| 50 | 80.5 | 223.1 | 24,300 | | | | | | | | | | | 50 |
| 55 | 79.2 | 222.0 | 24,200 | 19,600 | | | | | | | | | | 55 |
| 60 | 77.9 | 220.8 | 24,100 | 19,500 | 14,700 | 11,100 | | 80.7 | 216.8 | 16,500 | | | | 60 |
| 65 | 76.5 | 219.4 | 24,000 | 19,400 | 14,600 | 11,000 | | 79.3 | 215.4 | 16,100 | 15,100 | | | 65 |
| 70 | 75.2 | 217.9 | 21,600 | 19,300 | 14,500 | 11,000 | | 78.0 | 213.9 | 15,700 | 15,100 | 12,300 | 9,300 | 70 |
| 75 | 73.8 | 216.3 | 19,500 | 17,900 | 14,400 | 10,900 | | 76.6 | 212.2 | 15,300 | 15,000 | 12,300 | 9,200 | 75 |
| 80 | 72.4 | 214.6 | 17,700 | 16,300 | 14,300 | 10,900 | | 75.2 | 210.4 | 15,000 | 14,700 | 12,300 | 9,200 | 80 |
| 85 | 71.1 | 212.7 | 16,100 | 14,800 | 13,700 | 10,800 | | 73.8 | 208.5 | 14,600 | 14,400 | 12,300 | 9,200 | 85 |
| 90 | 69.7 | 210.7 | 14,700 | 13,600 | 12,500 | 10,700 | | 72.3 | 206.5 | 14,300 | 14,100 | 12,200 | 9,200 | 90 |
| 95 | 68.2 | 208.5 | 13,400 | 12,400 | 11,500 | 10,700 | | 70.9 | 204.2 | 14,000 | 13,100 | 12,100 | 9,200 | 95 |
| 100 | 66.8 | 206.2 | 12,300 | 11,400 | 10,600 | 9,800 | | 69.4 | 201.9 | 12,900 | 12,000 | 11,200 | 9,200 | 100 |
| 105 | 65.4 | 203.7 | 11,300 | 10,500 | 9,700 | 9,000 | | 67.9 | 199.4 | 11,900 | 11,000 | 10,300 | 9,100 | 105 |
| 110 | 63.9 | 201.1 | 10,400 | 9,600 | 9,000 | 8,300 | | 66.4 | 196.7 | 10,900 | 10,200 | 9,500 | 8,800 | 110 |
| 115 | 62.4 | 198.3 | 9,500 | 8,900 | 8,300 | 7,700 | | 64.9 | 193.8 | 10,000 | 9,400 | 8,700 | 8,100 | 115 |
| 120 | 60.9 | 195.3 | 8,800 | 8,200 | 7,600 | 7,100 | | 63.4 | 190.7 | 9,300 | 8,600 | 8,100 | 7,500 | 120 |
| 125 | 59.4 | 192.2 | 8,100 | 7,500 | 7,000 | 6,500 | | 61.8 | 187.5 | 8,500 | 8,000 | 7,400 | 6,900 | 125 |
| 130 | 57.8 | 188.8 | 7,500 | 7,000 | 6,500 | 6,000 | | 60.2 | 184.1 | 7,900 | 7,300 | 6,800 | 6,400 | 130 |
| 135 | 56.2 | 185.3 | 6,900 | 6,400 | 6,000 | 5,500 | | 58.6 | 180.4 | 7,200 | 6,800 | 6,300 | 5,900 | 135 |
| 140 | 54.6 | 181.5 | 6,300 | 5,900 | 5,500 | 5,100 | | 56.9 | 176.6 | 6,700 | 6,200 | 5,800 | 5,400 | 140 |
| 145 | 52.9 | 177.5 | 5,800 | 5,400 | 5,000 | 4,700 | | 55.2 | 172.4 | 6,100 | 5,700 | 5,300 | 5,000 | 145 |
| 150 | 51.2 | 173.3 | 5,400 | 5,000 | 4,600 | 4,300 | | 53.4 | 168.1 | 5,600 | 5,300 | 4,900 | 4,500 | 150 |
| 155 | 49.5 | 168.8 | 4,900 | 4,600 | 4,200 | 3,900 | | 51.6 | 163.4 | 5,200 | 4,800 | 4,500 | 4,200 | 155 |
| 160 | 47.7 | 164.0 | 4,500 | 4,200 | 3,900 | 3,600 | | 49.8 | 158.4 | 4,700 | 4,400 | 4,100 | 3,800 | 160 |
| 165 | 45.8 | 158.9 | 4,100 | 3,800 | 3,500 | 3,300 | | 47.9 | 153.1 | 4,300 | 4,000 | 3,700 | 3,500 | 165 |
| 170 | 43.9 | 153.4 | 3,800 | 3,500 | 3,200 | 3,000 | | 45.9 | 147.5 | 3,900 | 3,700 | 3,400 | 3,100 | 170 |
| 175 | 41.9 | 147.5 | 3,400 | 3,200 | 2,900 | 2,700 | | 43.8 | 141.4 | 3,600 | 3,300 | 3,100 | 2,800 | 175 |
| 180 | 39.8 | 141.3 | 3,100 | 2,900 | 2,600 | 2,400 | | 41.6 | 134.8 | 3,200 | 3,000 | 2,800 | 2,500 | 180 |
| 185 | 37.6 | 134.5 | 2,800 | 2,600 | 2,400 | 2,100 | | 39.3 | 127.6 | 2,900 | 2,700 | 2,500 | 2,200 | 185 |
| 190 | 35.3 | 127.1 | 2,300 | 2,200 | 2,000 | | | 36.8 | 119.8 | 2,500 | 2,300 | 2,200 | 2,000 | 190 |
| 195 | | | | | | | | 34.2 | 111.1 | 2,000 | | | | 195 |

MLC90A-1 S-2

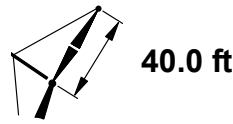
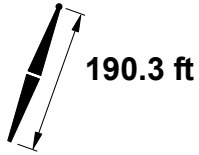
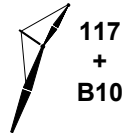

| | 10° | | | | | | | 30° | | | | | | | |
|-----|------|-------|--------|----------|----------|----------|----------|------|-------|--------|----------|----------|----------|----------|-----|
| | | | | | | | | | | | | | | | |
| | ft | ° | ft | 0° lb | 1° lb | 2° lb | 3° lb | ft | ° | ft | 0° lb | 1° lb | 2° lb | 3° lb | ft |
| 50 | 80.9 | 233.2 | 24,000 | | | | | | | | | | | | 50 |
| 55 | 79.7 | 232.1 | 23,900 | 17,500 | | | | | | | | | | | 55 |
| 60 | 78.4 | 230.9 | 23,600 | 17,500 | 12,900 | | | | | | | | | | 60 |
| 65 | 77.1 | 229.6 | 23,200 | 17,400 | 12,900 | 9,700 | | 79.8 | 225.6 | 16,300 | 14,800 | | | | 65 |
| 70 | 75.8 | 228.2 | 21,400 | 17,300 | 12,800 | 9,600 | | 78.5 | 224.1 | 15,900 | 14,700 | 11,000 | | | 70 |
| 75 | 74.5 | 226.7 | 19,200 | 17,300 | 12,800 | 9,600 | | 77.2 | 222.6 | 15,500 | 14,500 | 10,900 | 8,200 | | 75 |
| 80 | 73.2 | 225.0 | 17,400 | 15,900 | 12,800 | 9,600 | | 75.9 | 220.9 | 15,100 | 14,300 | 10,900 | 8,200 | | 80 |
| 85 | 71.9 | 223.2 | 15,800 | 14,500 | 12,700 | 9,600 | | 74.5 | 219.0 | 14,800 | 14,100 | 10,900 | 8,200 | | 85 |
| 90 | 70.6 | 221.3 | 14,400 | 13,200 | 12,200 | 9,500 | | 73.1 | 217.1 | 14,500 | 13,800 | 10,900 | 8,100 | | 90 |
| 95 | 69.2 | 219.2 | 13,100 | 12,100 | 11,100 | 9,500 | | 71.8 | 215.0 | 13,900 | 12,800 | 10,900 | 8,100 | | 95 |
| 100 | 67.9 | 217.0 | 12,000 | 11,100 | 10,200 | 9,400 | | 70.4 | 212.7 | 12,700 | 11,700 | 10,900 | 8,100 | | 100 |
| 105 | 66.5 | 214.7 | 11,000 | 10,200 | 9,400 | 8,700 | | 69.0 | 210.3 | 11,600 | 10,800 | 10,000 | 8,100 | | 105 |
| 110 | 65.1 | 212.2 | 10,100 | 9,300 | 8,600 | 8,000 | | 67.6 | 207.8 | 10,700 | 9,900 | 9,200 | 8,100 | | 110 |
| 115 | 63.7 | 209.6 | 9,300 | 8,600 | 7,900 | 7,300 | | 66.1 | 205.1 | 9,800 | 9,100 | 8,400 | 7,800 | | 115 |
| 120 | 62.3 | 206.8 | 8,500 | 7,900 | 7,300 | 6,700 | | 64.7 | 202.2 | 9,000 | 8,400 | 7,700 | 7,200 | | 120 |
| 125 | 60.8 | 203.8 | 7,800 | 7,200 | 6,700 | 6,200 | | 63.2 | 199.2 | 8,300 | 7,700 | 7,100 | 6,600 | | 125 |
| 130 | 59.4 | 200.6 | 7,200 | 6,600 | 6,100 | 5,700 | | 61.7 | 196.0 | 7,600 | 7,100 | 6,500 | 6,100 | | 130 |
| 135 | 57.9 | 197.3 | 6,600 | 6,100 | 5,600 | 5,200 | | 60.2 | 192.5 | 7,000 | 6,500 | 6,000 | 5,600 | | 135 |
| 140 | 56.4 | 193.8 | 6,100 | 5,600 | 5,200 | 4,800 | | 58.6 | 188.9 | 6,400 | 6,000 | 5,500 | 5,100 | | 140 |
| 145 | 54.8 | 190.1 | 5,500 | 5,100 | 4,700 | 4,300 | | 57.0 | 185.1 | 5,900 | 5,500 | 5,000 | 4,600 | | 145 |
| 150 | 53.2 | 186.1 | 5,100 | 4,700 | 4,300 | 4,000 | | 55.4 | 181.0 | 5,400 | 5,000 | 4,600 | 4,200 | | 150 |
| 155 | 51.6 | 181.9 | 4,600 | 4,300 | 3,900 | 3,600 | | 53.7 | 176.7 | 4,900 | 4,600 | 4,200 | 3,900 | | 155 |
| 160 | 50.0 | 177.5 | 4,200 | 3,900 | 3,600 | 3,300 | | 52.0 | 172.2 | 4,500 | 4,100 | 3,800 | 3,500 | | 160 |
| 165 | 48.3 | 172.8 | 3,800 | 3,500 | 3,200 | 2,900 | | 50.3 | 167.3 | 4,100 | 3,800 | 3,400 | 3,100 | | 165 |
| 170 | 46.5 | 167.8 | 3,500 | 3,200 | 2,900 | 2,600 | | 48.4 | 162.2 | 3,700 | 3,400 | 3,100 | 2,800 | | 170 |
| 175 | 44.7 | 162.5 | 3,100 | 2,900 | 2,600 | 2,300 | | 46.6 | 156.7 | 3,300 | 3,000 | 2,800 | 2,500 | | 175 |
| 180 | 42.8 | 156.9 | 2,800 | 2,600 | 2,300 | 2,100 | | 44.6 | 150.8 | 3,000 | 2,700 | 2,500 | 2,200 | | 180 |
| 185 | 40.9 | 150.8 | 2,500 | 2,300 | 2,000 | | | 42.6 | 144.5 | 2,600 | 2,400 | 2,200 | | | 185 |
| 190 | 38.8 | 144.3 | 2,000 | | | | | 40.4 | 137.6 | 2,300 | 2,100 | | | | 190 |

MLC90A-1 S-2

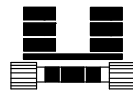
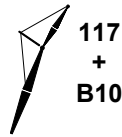

73,000 lb
+
23,100 lb

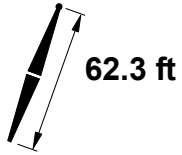

62.3 ft

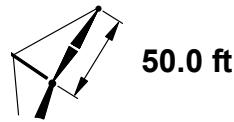

50.0 ft

| | 10° | | | | | | | 30° | | | | | | |
|-----|------|-------|--------|--------|--------|--------|------|-------|--------|--------|--------|--------|----|-----|
| | | | | | | | | | | | | | | |
| | | | | | | | | | | | | | | |
| ft | ° | ft | lb | lb | lb | lb | ° | ft | lb | lb | lb | lb | ft | |
| 34 | 80.5 | 116.0 | 23,000 | | | | | | | | | | | 34 |
| 36 | 79.4 | 115.5 | 22,800 | 19,600 | | | | | | | | | | 36 |
| 38 | 78.4 | 114.9 | 22,500 | 19,500 | 16,800 | | | | | | | | | 38 |
| 40 | 77.3 | 114.3 | 22,300 | 19,300 | 16,700 | 14,700 | | | | | | | | 40 |
| 42 | 76.2 | 113.6 | 22,100 | 19,100 | 16,600 | 14,700 | | | | | | | | 42 |
| 44 | 75.2 | 112.8 | 21,900 | 19,000 | 16,500 | 14,600 | | | | | | | | 44 |
| 46 | 74.1 | 112.1 | 21,700 | 18,800 | 16,400 | 14,500 | | | | | | | | 46 |
| 48 | 73.0 | 111.3 | 21,500 | 18,700 | 16,300 | 14,400 | 80.1 | 107.8 | 14,200 | | | | | 48 |
| 50 | 71.9 | 110.4 | 21,300 | 18,500 | 16,100 | 14,300 | 79.0 | 106.9 | 13,800 | 13,600 | 12,400 | | | 50 |
| 55 | 69.1 | 108.1 | 20,900 | 18,200 | 15,900 | 14,100 | 76.1 | 104.4 | 13,100 | 12,900 | 11,900 | 10,700 | | 55 |
| 60 | 66.2 | 105.4 | 20,500 | 17,900 | 15,600 | 13,900 | 73.1 | 101.7 | 12,400 | 12,200 | 11,400 | 10,300 | | 60 |
| 65 | 63.3 | 102.4 | 19,600 | 17,600 | 15,400 | 13,700 | 70.1 | 98.6 | 11,800 | 11,700 | 11,100 | 9,900 | | 65 |
| 70 | 60.2 | 99.1 | 18,300 | 17,300 | 15,200 | 13,600 | 66.9 | 95.1 | 11,300 | 11,200 | 10,700 | 9,700 | | 70 |
| 75 | 57.0 | 95.3 | 17,100 | 16,500 | 15,000 | 13,400 | 63.5 | 91.2 | 10,900 | 10,700 | 10,300 | 9,400 | | 75 |
| 80 | 53.7 | 91.1 | 16,000 | 15,500 | 14,900 | 13,300 | 60.0 | 86.7 | 10,400 | 10,300 | 10,000 | 9,200 | | 80 |
| 85 | 50.2 | 86.4 | 15,100 | 14,700 | 14,300 | 13,100 | 56.3 | 81.7 | 10,100 | 10,000 | 9,700 | 8,900 | | 85 |
| 90 | 46.5 | 80.9 | 14,300 | 13,900 | 13,600 | 13,100 | 52.4 | 75.9 | 9,700 | 9,700 | 9,500 | 8,700 | | 90 |
| 95 | 42.4 | 74.8 | 13,600 | 13,300 | 12,900 | 12,600 | 48.0 | 69.2 | 9,400 | 9,400 | 9,200 | 8,500 | | 95 |
| 100 | 38.0 | 67.5 | 13,000 | 12,800 | 12,400 | 12,100 | 43.1 | 61.2 | 9,200 | 9,100 | 9,100 | 8,400 | | 100 |
| 105 | 32.9 | 58.8 | 12,500 | 12,300 | 12,000 | 11,700 | 37.3 | 51.3 | 9,000 | 9,000 | 9,000 | 8,300 | | 105 |
| 110 | 26.7 | 47.7 | 12,200 | 12,000 | 11,700 | 11,500 | | | | | | | | 110 |

MLC90A-1 S-2

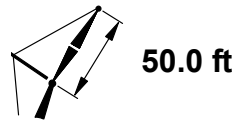
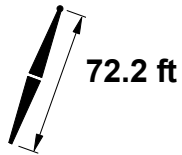
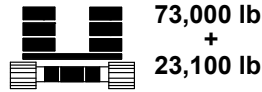
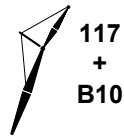

| | 10° | | | | | | | 30° | | | | | | | |
|-----|------|-------|--------|----------|----------|----------|----------|-------|--------|--------|----------|----------|----------|----------|-----|
| | | | | | | | | | | | | | | | |
| | ft | ° | ft | 0° lb | 1° lb | 2° lb | 3° lb | ft | ° | ft | 0° lb | 1° lb | 2° lb | 3° lb | ft |
| 36 | 80.3 | 125.7 | 22,800 | | | | | | | | | | | | 36 |
| 38 | 79.3 | 125.1 | 22,700 | 19,500 | | | | | | | | | | | 38 |
| 40 | 78.4 | 124.5 | 22,500 | 19,400 | 16,700 | | | | | | | | | | 40 |
| 42 | 77.4 | 123.9 | 22,300 | 19,300 | 16,700 | 14,700 | | | | | | | | | 42 |
| 44 | 76.4 | 123.2 | 22,100 | 19,100 | 16,500 | 14,600 | | | | | | | | | 44 |
| 46 | 75.4 | 122.6 | 21,900 | 19,000 | 16,500 | 14,500 | | | | | | | | | 46 |
| 48 | 74.4 | 121.8 | 21,700 | 18,800 | 16,400 | 14,500 | | | | | | | | | 48 |
| 50 | 73.4 | 121.0 | 21,500 | 18,700 | 16,300 | 14,400 | 80.0 | 117.3 | 14,100 | 13,800 | | | | | 50 |
| 55 | 70.9 | 118.9 | 21,200 | 18,400 | 16,000 | 14,200 | 77.4 | 115.1 | 13,400 | 13,100 | 12,900 | 10,600 | | | 55 |
| 60 | 68.3 | 116.5 | 20,700 | 18,100 | 15,800 | 14,000 | 74.7 | 112.7 | 12,800 | 12,500 | 12,300 | 10,600 | | | 60 |
| 65 | 65.7 | 113.9 | 20,400 | 17,900 | 15,600 | 13,800 | 71.9 | 109.9 | 12,200 | 12,000 | 11,800 | 10,600 | | | 65 |
| 70 | 62.9 | 110.9 | 20,000 | 17,600 | 15,400 | 13,700 | 69.1 | 106.8 | 11,700 | 11,500 | 11,400 | 10,600 | | | 70 |
| 75 | 60.1 | 107.6 | 19,700 | 17,400 | 15,200 | 13,600 | 66.2 | 103.3 | 11,200 | 11,100 | 10,900 | 10,500 | | | 75 |
| 80 | 57.2 | 103.9 | 18,800 | 17,100 | 15,000 | 13,400 | 63.2 | 99.5 | 10,800 | 10,700 | 10,600 | 10,200 | | | 80 |
| 85 | 54.2 | 99.8 | 17,900 | 16,900 | 14,900 | 13,300 | 60.0 | 95.2 | 10,400 | 10,300 | 10,200 | 10,000 | | | 85 |
| 90 | 51.1 | 95.2 | 17,000 | 16,800 | 14,800 | 13,200 | 56.7 | 90.3 | 10,100 | 10,000 | 9,900 | 9,800 | | | 90 |
| 95 | 47.7 | 90.1 | 16,200 | 15,700 | 14,700 | 13,100 | 53.1 | 84.9 | 9,800 | 9,700 | 9,600 | 9,600 | | | 95 |
| 100 | 44.1 | 84.3 | 15,100 | 14,600 | 14,200 | 13,000 | 49.3 | 78.7 | 9,500 | 9,400 | 9,400 | 9,300 | | | 100 |
| 105 | 40.3 | 77.7 | 14,100 | 13,700 | 13,300 | 12,900 | 45.1 | 71.5 | 9,300 | 9,200 | 9,200 | 9,100 | | | 105 |
| 110 | 36.0 | 70.0 | 13,200 | 12,800 | 12,500 | 12,100 | 40.3 | 63.0 | 9,100 | 9,100 | 9,000 | 9,000 | | | 110 |
| 115 | 31.1 | 60.7 | 12,300 | 12,000 | 11,700 | 11,400 | 34.7 | 52.3 | 8,900 | 8,900 | 8,900 | 8,900 | | | 115 |
| 120 | 25.1 | 48.9 | 11,500 | 11,300 | 11,000 | 10,800 | | | | | | | | | 120 |

MLC90A-1 S-2

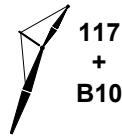

73,000 lb
+
23,100 lb

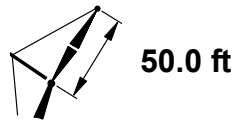
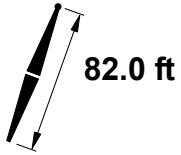

| | 10° | | | | | | | 30° | | | | | | |
|-----|------|-------|--------|----------|----------|----------|----------|-------|--------|----------|----------|----------|----------|-----|
| | | | | | | | | | | | | | | |
| | ft | ° | ft | 0° lb | 1° lb | 2° lb | 3° lb | ° | ft | 0° lb | 1° lb | 2° lb | 3° lb | ft |
| 38 | 80.2 | 135.3 | 22,800 | | | | | | | | | | | 38 |
| 40 | 79.3 | 134.7 | 22,600 | 19,400 | | | | | | | | | | 40 |
| 42 | 78.4 | 134.2 | 22,400 | 19,300 | 16,700 | | | | | | | | | 42 |
| 44 | 77.5 | 133.6 | 22,200 | 19,200 | 16,600 | 14,700 | | | | | | | | 44 |
| 46 | 76.5 | 132.9 | 22,100 | 19,100 | 16,500 | 14,600 | | | | | | | | 46 |
| 48 | 75.6 | 132.2 | 21,900 | 18,900 | 16,400 | 14,500 | | | | | | | | 48 |
| 50 | 74.7 | 131.5 | 21,700 | 18,800 | 16,300 | 14,400 | 80.8 | 127.7 | 14,300 | | | | | 50 |
| 55 | 72.4 | 129.6 | 21,400 | 18,600 | 16,100 | 14,200 | 78.4 | 125.7 | 13,600 | 13,400 | 12,500 | | | 55 |
| 60 | 70.0 | 127.4 | 21,000 | 18,200 | 15,900 | 14,100 | 76.0 | 123.4 | 13,000 | 12,800 | 12,500 | 10,300 | | 60 |
| 65 | 67.6 | 125.0 | 20,700 | 18,000 | 15,700 | 13,900 | 73.5 | 120.9 | 12,500 | 12,300 | 12,100 | 10,300 | | 65 |
| 70 | 65.2 | 122.3 | 20,300 | 17,800 | 15,600 | 13,800 | 70.9 | 118.1 | 12,000 | 11,800 | 11,600 | 10,300 | | 70 |
| 75 | 62.7 | 119.3 | 20,000 | 17,600 | 15,300 | 13,700 | 68.3 | 115.0 | 11,500 | 11,400 | 11,200 | 10,300 | | 75 |
| 80 | 60.1 | 116.0 | 19,800 | 17,300 | 15,200 | 13,500 | 65.6 | 111.6 | 11,100 | 11,000 | 10,800 | 10,300 | | 80 |
| 85 | 57.4 | 112.4 | 18,600 | 17,100 | 15,100 | 13,400 | 62.8 | 107.8 | 10,700 | 10,600 | 10,500 | 10,300 | | 85 |
| 90 | 54.6 | 108.4 | 17,200 | 16,500 | 14,900 | 13,300 | 59.9 | 103.6 | 10,400 | 10,300 | 10,200 | 10,100 | | 90 |
| 95 | 51.8 | 104.0 | 16,000 | 15,400 | 14,800 | 13,200 | 56.9 | 99.0 | 10,100 | 10,000 | 9,900 | 9,800 | | 95 |
| 100 | 48.7 | 99.1 | 14,800 | 14,300 | 13,800 | 13,200 | 53.7 | 93.8 | 9,800 | 9,700 | 9,700 | 9,600 | | 100 |
| 105 | 45.5 | 93.6 | 13,800 | 13,400 | 12,900 | 12,500 | 50.3 | 87.9 | 9,600 | 9,500 | 9,400 | 9,400 | | 105 |
| 110 | 42.1 | 87.4 | 12,900 | 12,500 | 12,100 | 11,700 | 46.6 | 81.3 | 9,300 | 9,300 | 9,200 | 9,200 | | 110 |
| 115 | 38.4 | 80.4 | 12,100 | 11,700 | 11,400 | 11,000 | 42.5 | 73.7 | 9,200 | 9,100 | 9,100 | 9,100 | | 115 |
| 120 | 34.3 | 72.3 | 11,300 | 11,000 | 10,700 | 10,400 | 37.9 | 64.6 | 9,000 | 9,000 | 9,000 | 8,900 | | 120 |
| 125 | 29.5 | 62.5 | 10,600 | 10,300 | 10,100 | 9,800 | 32.4 | 53.2 | 8,900 | 8,900 | 8,900 | 8,900 | | 125 |
| 130 | 23.7 | 50.1 | 9,900 | 9,700 | 9,500 | 9,300 | | | | | | | | 130 |

MLC90A-1 S-2

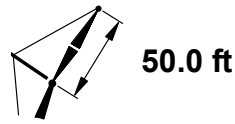
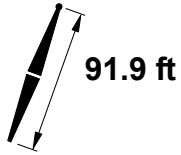
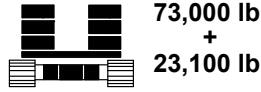
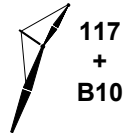

| | 10° | | | | | | | | 30° | | | | | | | |
|-----|------|-------|--------|--------|--------|--------|------|-------|--------|--------|--------|--------|----|-----|--|--|
| | | | | | | | | | | | | | | | | |
| | ft | ° | ft | lb | lb | lb | lb | ° | ft | lb | lb | lb | lb | ft | | |
| 38 | 80.9 | 145.4 | 22,800 | | | | | | | | | | | 38 | | |
| 40 | 80.0 | 144.9 | 22,700 | | | | | | | | | | | 40 | | |
| 42 | 79.2 | 144.4 | 22,500 | 19,400 | | | | | | | | | | 42 | | |
| 44 | 78.4 | 143.8 | 22,300 | 19,200 | 16,600 | | | | | | | | | 44 | | |
| 46 | 77.5 | 143.2 | 22,200 | 19,100 | 16,500 | 14,600 | | | | | | | | 46 | | |
| 48 | 76.7 | 142.6 | 22,000 | 19,000 | 16,500 | 14,500 | | | | | | | | 48 | | |
| 50 | 75.8 | 141.9 | 21,900 | 18,900 | 16,400 | 14,400 | | | | | | | | 50 | | |
| 55 | 73.7 | 140.1 | 21,600 | 18,700 | 16,200 | 14,300 | 79.3 | 136.1 | 13,900 | 13,600 | | | | 55 | | |
| 60 | 71.5 | 138.1 | 21,200 | 18,400 | 16,000 | 14,200 | 77.1 | 134.0 | 13,300 | 13,000 | 12,200 | 10,000 | | 60 | | |
| 65 | 69.3 | 135.9 | 20,900 | 18,100 | 15,800 | 14,000 | 74.8 | 131.7 | 12,800 | 12,500 | 12,100 | 10,000 | | 65 | | |
| 70 | 67.1 | 133.5 | 20,700 | 17,900 | 15,600 | 13,900 | 72.5 | 129.2 | 12,300 | 12,100 | 11,900 | 10,000 | | 70 | | |
| 75 | 64.8 | 130.7 | 20,300 | 17,700 | 15,500 | 13,800 | 70.1 | 126.4 | 11,800 | 11,700 | 11,500 | 10,000 | | 75 | | |
| 80 | 62.4 | 127.8 | 20,000 | 17,500 | 15,300 | 13,600 | 67.7 | 123.3 | 11,400 | 11,300 | 11,100 | 10,000 | | 80 | | |
| 85 | 60.0 | 124.5 | 18,400 | 17,400 | 15,200 | 13,500 | 65.2 | 119.9 | 11,100 | 10,900 | 10,800 | 10,000 | | 85 | | |
| 90 | 57.6 | 120.9 | 17,000 | 16,300 | 15,100 | 13,400 | 62.6 | 116.2 | 10,700 | 10,600 | 10,500 | 10,000 | | 90 | | |
| 95 | 55.0 | 117.0 | 15,800 | 15,100 | 14,500 | 13,400 | 59.9 | 112.1 | 10,400 | 10,300 | 10,200 | 10,000 | | 95 | | |
| 100 | 52.4 | 112.7 | 14,700 | 14,100 | 13,600 | 13,000 | 57.1 | 107.6 | 10,100 | 10,000 | 9,900 | 9,800 | | 100 | | |
| 105 | 49.6 | 108.0 | 13,600 | 13,100 | 12,700 | 12,200 | 54.2 | 102.6 | 9,900 | 9,800 | 9,700 | 9,600 | | 105 | | |
| 110 | 46.7 | 102.7 | 12,700 | 12,300 | 11,900 | 11,400 | 51.1 | 97.0 | 9,600 | 9,600 | 9,500 | 9,400 | | 110 | | |
| 115 | 43.6 | 96.9 | 11,900 | 11,500 | 11,100 | 10,800 | 47.8 | 90.8 | 9,400 | 9,400 | 9,300 | 9,300 | | 115 | | |
| 120 | 40.3 | 90.4 | 11,100 | 10,800 | 10,400 | 10,100 | 44.3 | 83.8 | 9,200 | 9,200 | 9,100 | 9,100 | | 120 | | |
| 125 | 36.7 | 83.0 | 10,400 | 10,100 | 9,800 | 9,500 | 40.3 | 75.7 | 9,100 | 9,000 | 9,000 | 9,000 | | 125 | | |
| 130 | 32.7 | 74.5 | 9,800 | 9,500 | 9,300 | 9,000 | 35.9 | 66.1 | 9,000 | 8,900 | 8,900 | 8,900 | | 130 | | |
| 135 | 28.1 | 64.2 | 9,200 | 9,000 | 8,700 | 8,500 | 30.5 | 54.1 | 8,900 | 8,900 | 8,800 | 8,600 | | 135 | | |
| 140 | 22.5 | 51.1 | 8,600 | 8,400 | 8,200 | 8,000 | | | | | | | | 140 | | |

MLC90A-1 S-2

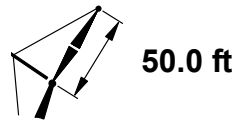
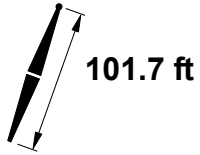
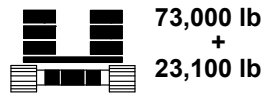
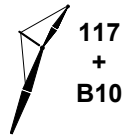

| | 10° | | | | | | | 30° | | | | | | |
|-----|------|-------|--------|----------|----------|----------|----------|-------|--------|----------|----------|----------|----------|-----|
| | | | | | | | | | | | | | | |
| | ft | ° | ft | 0° lb | 1° lb | 2° lb | 3° lb | ° | ft | 0° lb | 1° lb | 2° lb | 3° lb | ft |
| 40 | 80.7 | 155.0 | 22,700 | | | | | | | | | | | 40 |
| 42 | 79.9 | 154.5 | 22,600 | 19,400 | | | | | | | | | | 42 |
| 44 | 79.1 | 154.0 | 22,400 | 19,200 | | | | | | | | | | 44 |
| 46 | 78.3 | 153.4 | 22,300 | 19,200 | 16,500 | | | | | | | | | 46 |
| 48 | 77.6 | 152.9 | 22,100 | 19,000 | 16,400 | 14,500 | | | | | | | | 48 |
| 50 | 76.8 | 152.2 | 22,000 | 18,900 | 16,400 | 14,400 | | | | | | | | 50 |
| 55 | 74.8 | 150.6 | 21,700 | 18,700 | 16,200 | 14,300 | 80.0 | 146.5 | 14,100 | | | | | 55 |
| 60 | 72.8 | 148.7 | 21,400 | 18,500 | 16,000 | 14,100 | 78.0 | 144.5 | 13,500 | 13,300 | 11,800 | 9,800 | | 60 |
| 65 | 70.8 | 146.7 | 21,100 | 18,300 | 15,900 | 14,000 | 75.9 | 142.4 | 13,000 | 12,800 | 11,800 | 9,800 | | 65 |
| 70 | 68.7 | 144.4 | 20,900 | 18,100 | 15,700 | 13,900 | 73.7 | 140.1 | 12,500 | 12,300 | 11,800 | 9,800 | | 70 |
| 75 | 66.6 | 141.9 | 20,600 | 17,900 | 15,500 | 13,800 | 71.6 | 137.5 | 12,100 | 11,900 | 11,700 | 9,800 | | 75 |
| 80 | 64.4 | 139.2 | 19,800 | 17,700 | 15,400 | 13,700 | 69.4 | 134.7 | 11,700 | 11,500 | 11,400 | 9,800 | | 80 |
| 85 | 62.2 | 136.2 | 18,200 | 17,300 | 15,400 | 13,600 | 67.1 | 131.6 | 11,300 | 11,200 | 11,000 | 9,800 | | 85 |
| 90 | 60.0 | 133.0 | 16,800 | 16,000 | 15,200 | 13,500 | 64.8 | 128.2 | 11,000 | 10,900 | 10,700 | 9,800 | | 90 |
| 95 | 57.7 | 129.4 | 15,500 | 14,800 | 14,200 | 13,400 | 62.4 | 124.6 | 10,700 | 10,600 | 10,400 | 9,800 | | 95 |
| 100 | 55.3 | 125.6 | 14,400 | 13,800 | 13,200 | 12,700 | 59.9 | 120.5 | 10,400 | 10,300 | 10,200 | 9,800 | | 100 |
| 105 | 52.9 | 121.4 | 13,400 | 12,800 | 12,300 | 11,800 | 57.3 | 116.1 | 10,100 | 10,000 | 9,900 | 9,800 | | 105 |
| 110 | 50.3 | 116.8 | 12,500 | 12,000 | 11,500 | 11,100 | 54.6 | 111.3 | 9,900 | 9,800 | 9,700 | 9,700 | | 110 |
| 115 | 47.6 | 111.8 | 11,600 | 11,200 | 10,800 | 10,400 | 51.8 | 106.0 | 9,700 | 9,600 | 9,500 | 9,500 | | 115 |
| 120 | 44.8 | 106.2 | 10,900 | 10,500 | 10,100 | 9,800 | 48.8 | 100.2 | 9,500 | 9,400 | 9,400 | 9,300 | | 120 |
| 125 | 41.9 | 100.1 | 10,200 | 9,800 | 9,500 | 9,200 | 45.6 | 93.6 | 9,300 | 9,200 | 9,200 | 9,200 | | 125 |
| 130 | 38.7 | 93.3 | 9,500 | 9,200 | 8,900 | 8,600 | 42.2 | 86.2 | 9,100 | 9,100 | 9,100 | 8,800 | | 130 |
| 135 | 35.2 | 85.5 | 9,000 | 8,700 | 8,400 | 8,100 | 38.4 | 77.7 | 9,000 | 8,800 | 8,500 | 8,300 | | 135 |
| 140 | 31.3 | 76.5 | 8,400 | 8,100 | 7,900 | 7,700 | 34.0 | 67.5 | 8,500 | 8,200 | 8,000 | 7,800 | | 140 |
| 145 | 26.9 | 65.8 | 7,900 | 7,700 | 7,400 | 7,200 | | | | | | | | 145 |
| 150 | 21.4 | 52.1 | 7,300 | 7,200 | 7,000 | 6,800 | | | | | | | | 150 |

MLC90A-1 S-2

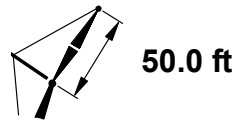
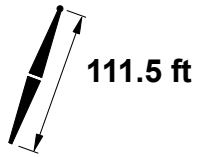
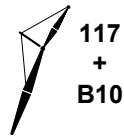

| | 10° | | | | | | | 30° | | | | | | | |
|-----|------|-------|--------|----------|----------|----------|----------|-------|--------|--------|----------|----------|----------|----------|-----|
| | | | | | | | | | | | | | | | |
| | ft | ° | ft | 0° lb | 1° lb | 2° lb | 3° lb | ft | ° | ft | 0° lb | 1° lb | 2° lb | 3° lb | ft |
| 42 | 80.5 | 164.6 | 22,500 | | | | | | | | | | | | 42 |
| 44 | 79.8 | 164.1 | 22,400 | 19,200 | | | | | | | | | | | 44 |
| 46 | 79.1 | 163.6 | 22,300 | 19,100 | | | | | | | | | | | 46 |
| 48 | 78.3 | 163.1 | 22,200 | 19,000 | 16,400 | | | | | | | | | | 48 |
| 50 | 77.6 | 162.5 | 22,100 | 18,900 | 16,300 | 14,400 | | | | | | | | | 50 |
| 55 | 75.8 | 161.0 | 21,800 | 18,700 | 16,200 | 14,200 | 80.7 | 156.7 | 14,300 | | | | | | 55 |
| 60 | 73.9 | 159.2 | 21,500 | 18,500 | 16,000 | 14,200 | 78.8 | 155.0 | 13,700 | 13,500 | 11,600 | | | | 60 |
| 65 | 72.0 | 157.3 | 21,300 | 18,300 | 15,900 | 14,100 | 76.8 | 153.0 | 13,200 | 13,000 | 11,600 | 9,600 | | | 65 |
| 70 | 70.1 | 155.2 | 21,000 | 18,200 | 15,700 | 14,000 | 74.8 | 150.8 | 12,800 | 12,500 | 11,500 | 9,600 | 9,600 | | 70 |
| 75 | 68.1 | 152.9 | 20,700 | 18,000 | 15,600 | 13,800 | 72.8 | 148.4 | 12,300 | 12,100 | 11,500 | 9,600 | 9,600 | | 75 |
| 80 | 66.1 | 150.4 | 19,600 | 17,800 | 15,500 | 13,800 | 70.8 | 145.8 | 11,900 | 11,800 | 11,500 | 9,600 | 9,600 | | 80 |
| 85 | 64.1 | 147.6 | 18,000 | 17,000 | 15,400 | 13,600 | 68.7 | 143.0 | 11,600 | 11,400 | 11,300 | 9,600 | 9,600 | | 85 |
| 90 | 62.1 | 144.7 | 16,500 | 15,700 | 15,000 | 13,600 | 66.6 | 139.9 | 11,200 | 11,100 | 11,000 | 9,600 | 9,600 | | 90 |
| 95 | 60.0 | 141.4 | 15,300 | 14,600 | 13,900 | 13,200 | 64.4 | 136.6 | 10,900 | 10,800 | 10,700 | 9,600 | 9,600 | | 95 |
| 100 | 57.8 | 137.9 | 14,200 | 13,500 | 12,900 | 12,300 | 62.2 | 132.9 | 10,600 | 10,500 | 10,400 | 9,600 | 9,600 | | 100 |
| 105 | 55.6 | 134.1 | 13,200 | 12,600 | 12,000 | 11,500 | 59.8 | 129.0 | 10,400 | 10,300 | 10,200 | 9,600 | 9,600 | | 105 |
| 110 | 53.3 | 130.0 | 12,300 | 11,700 | 11,200 | 10,700 | 57.5 | 124.7 | 10,100 | 10,000 | 10,000 | 9,600 | 9,600 | | 110 |
| 115 | 50.9 | 125.6 | 11,400 | 11,000 | 10,500 | 10,100 | 55.0 | 120.0 | 9,900 | 9,800 | 9,700 | 9,600 | 9,600 | | 115 |
| 120 | 48.5 | 120.7 | 10,700 | 10,200 | 9,800 | 9,400 | 52.4 | 114.9 | 9,700 | 9,600 | 9,600 | 9,600 | 9,500 | | 120 |
| 125 | 45.9 | 115.4 | 10,000 | 9,600 | 9,200 | 8,900 | 49.7 | 109.3 | 9,500 | 9,500 | 9,400 | 9,400 | 9,100 | | 125 |
| 130 | 43.2 | 109.6 | 9,300 | 9,000 | 8,600 | 8,300 | 46.8 | 103.1 | 9,300 | 9,200 | 8,900 | 8,900 | 8,600 | | 130 |
| 135 | 40.3 | 103.2 | 8,700 | 8,400 | 8,100 | 7,800 | 43.7 | 96.2 | 8,900 | 8,600 | 8,300 | 8,300 | 8,000 | | 135 |
| 140 | 37.2 | 96.0 | 8,200 | 7,900 | 7,600 | 7,400 | 40.3 | 88.5 | 8,300 | 8,100 | 7,800 | 7,800 | 7,500 | | 140 |
| 145 | 33.8 | 87.9 | 7,700 | 7,400 | 7,200 | 6,900 | 36.6 | 79.5 | 7,800 | 7,500 | 7,300 | 7,300 | 7,100 | | 145 |
| 150 | 30.1 | 78.5 | 7,200 | 7,000 | 6,700 | 6,500 | 32.4 | 68.9 | 7,300 | 7,000 | 6,800 | 6,800 | 6,600 | | 150 |
| 155 | 25.7 | 67.3 | 6,700 | 6,500 | 6,300 | 6,100 | | | | | | | | | 155 |
| 160 | 20.4 | 52.9 | 6,000 | 5,900 | 5,800 | 5,800 | | | | | | | | | 160 |

MLC90A-1 S-2



73,000 lb
+
23,100 lb

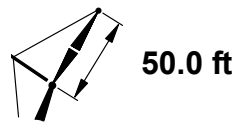
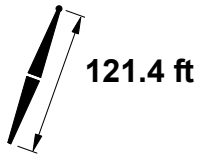

| | 10° | | | | | | | 30° | | | | | | |
|-----|------|-------|--------|----------|----------|----------|----------|-------|--------|----------|----------|----------|----------|-----|
| | | | | | | | | | | | | | | |
| | ft | ° | ft | 0° lb | 1° lb | 2° lb | 3° lb | ° | ft | 0° lb | 1° lb | 2° lb | 3° lb | ft |
| 44 | 80.4 | 174.2 | 22,400 | | | | | | | | | | | 44 |
| 46 | 79.7 | 173.8 | 22,300 | 19,000 | | | | | | | | | | 46 |
| 48 | 79.0 | 173.2 | 22,200 | 19,000 | | | | | | | | | | 48 |
| 50 | 78.3 | 172.7 | 22,100 | 18,900 | 16,200 | | | | | | | | | 50 |
| 55 | 76.6 | 171.3 | 21,800 | 18,700 | 16,100 | 14,200 | | | | | | | | 55 |
| 60 | 74.9 | 169.6 | 21,600 | 18,500 | 16,000 | 14,100 | 79.5 | 165.3 | 13,900 | 13,600 | | | | 60 |
| 65 | 73.1 | 167.9 | 21,300 | 18,400 | 15,900 | 14,000 | 77.6 | 163.5 | 13,400 | 13,200 | 11,300 | 9,400 | | 65 |
| 70 | 71.3 | 165.9 | 21,100 | 18,200 | 15,700 | 13,900 | 75.8 | 161.4 | 13,000 | 12,700 | 11,300 | 9,400 | | 70 |
| 75 | 69.5 | 163.7 | 20,900 | 18,100 | 15,700 | 13,800 | 73.9 | 159.2 | 12,600 | 12,400 | 11,300 | 9,400 | | 75 |
| 80 | 67.6 | 161.4 | 19,300 | 17,900 | 15,600 | 13,700 | 72.0 | 156.8 | 12,200 | 12,000 | 11,300 | 9,400 | | 80 |
| 85 | 65.8 | 158.9 | 17,700 | 16,700 | 15,400 | 13,600 | 70.1 | 154.2 | 11,800 | 11,600 | 11,200 | 9,400 | | 85 |
| 90 | 63.9 | 156.1 | 16,300 | 15,400 | 14,600 | 13,600 | 68.1 | 151.3 | 11,500 | 11,300 | 11,200 | 9,400 | | 90 |
| 95 | 61.9 | 153.1 | 15,000 | 14,300 | 13,500 | 12,800 | 66.1 | 148.3 | 11,200 | 11,000 | 10,900 | 9,400 | | 95 |
| 100 | 59.9 | 149.9 | 13,900 | 13,200 | 12,600 | 11,900 | 64.1 | 144.9 | 10,900 | 10,800 | 10,600 | 9,400 | | 100 |
| 105 | 57.9 | 146.4 | 12,900 | 12,300 | 11,700 | 11,100 | 62.0 | 141.3 | 10,600 | 10,500 | 10,400 | 9,400 | | 105 |
| 110 | 55.8 | 142.7 | 12,000 | 11,400 | 10,900 | 10,400 | 59.8 | 137.5 | 10,400 | 10,300 | 10,200 | 9,400 | | 110 |
| 115 | 53.7 | 138.7 | 11,200 | 10,700 | 10,200 | 9,700 | 57.6 | 133.3 | 10,100 | 10,100 | 10,000 | 9,400 | | 115 |
| 120 | 51.5 | 134.3 | 10,400 | 9,900 | 9,500 | 9,100 | 55.3 | 128.7 | 9,900 | 9,900 | 9,800 | 9,400 | | 120 |
| 125 | 49.2 | 129.6 | 9,700 | 9,300 | 8,900 | 8,500 | 52.9 | 123.8 | 9,700 | 9,600 | 9,200 | 8,800 | | 125 |
| 130 | 46.8 | 124.5 | 9,100 | 8,700 | 8,300 | 8,000 | 50.4 | 118.4 | 9,400 | 9,000 | 8,600 | 8,300 | | 130 |
| 135 | 44.3 | 118.9 | 8,500 | 8,100 | 7,800 | 7,500 | 47.7 | 112.5 | 8,700 | 8,400 | 8,000 | 7,700 | | 135 |
| 140 | 41.7 | 112.8 | 7,900 | 7,600 | 7,300 | 7,000 | 44.9 | 106.0 | 8,100 | 7,800 | 7,500 | 7,200 | | 140 |
| 145 | 38.9 | 106.1 | 7,400 | 7,100 | 6,900 | 6,600 | 41.9 | 98.8 | 7,600 | 7,300 | 7,000 | 6,800 | | 145 |
| 150 | 35.9 | 98.6 | 6,900 | 6,700 | 6,400 | 6,200 | 38.7 | 90.6 | 7,100 | 6,800 | 6,600 | 6,300 | | 150 |
| 155 | 32.6 | 90.1 | 6,500 | 6,300 | 6,000 | 5,800 | 35.0 | 81.3 | 6,600 | 6,400 | 6,100 | 5,900 | | 155 |
| 160 | 28.9 | 80.4 | 6,100 | 5,900 | 5,600 | 5,400 | 30.9 | 70.2 | 6,100 | 5,900 | 5,700 | 5,500 | | 160 |
| 165 | 24.7 | 68.7 | 5,700 | 5,500 | 5,300 | 5,100 | | | | | | | | 165 |

MLC90A-1 S-2

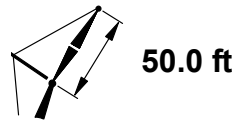
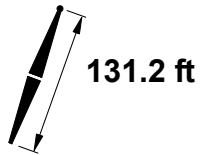
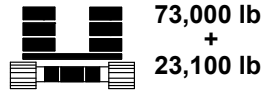
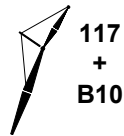

| | 10° | | | | | | | 30° | | | | | | |
|-----|------|-------|--------|----------|----------|----------|----------|-------|--------|----------|----------|----------|----------|-----|
| | | | | | | | | | | | | | | |
| | ft | ° | ft | 0° lb | 1° lb | 2° lb | 3° lb | ° | ft | 0° lb | 1° lb | 2° lb | 3° lb | ft |
| 44 | 80.9 | 184.3 | 22,300 | | | | | | | | | | | 44 |
| 46 | 80.3 | 183.9 | 22,300 | | | | | | | | | | | 46 |
| 48 | 79.6 | 183.4 | 22,100 | 18,900 | | | | | | | | | | 48 |
| 50 | 79.0 | 182.9 | 22,100 | 18,800 | 16,200 | | | | | | | | | 50 |
| 55 | 77.4 | 181.5 | 21,800 | 18,700 | 16,100 | 14,100 | | | | | | | | 55 |
| 60 | 75.7 | 180.0 | 21,600 | 18,500 | 16,000 | 14,000 | 80.1 | 175.6 | 14,100 | | | | | 60 |
| 65 | 74.0 | 178.3 | 21,400 | 18,400 | 15,800 | 14,000 | 78.4 | 173.8 | 13,600 | 13,300 | 11,100 | | | 65 |
| 70 | 72.4 | 176.5 | 21,200 | 18,200 | 15,700 | 13,800 | 76.6 | 171.9 | 13,200 | 12,900 | 11,100 | 9,200 | | 70 |
| 75 | 70.7 | 174.4 | 20,900 | 18,100 | 15,600 | 13,800 | 74.9 | 169.9 | 12,800 | 12,500 | 11,000 | 9,200 | | 75 |
| 80 | 68.9 | 172.3 | 19,100 | 17,900 | 15,500 | 13,700 | 73.1 | 167.6 | 12,400 | 12,200 | 11,000 | 9,200 | | 80 |
| 85 | 67.2 | 169.9 | 17,500 | 16,500 | 15,400 | 13,700 | 71.3 | 165.2 | 12,000 | 11,900 | 11,000 | 9,200 | | 85 |
| 90 | 65.4 | 167.3 | 16,100 | 15,200 | 14,300 | 13,500 | 69.5 | 162.5 | 11,700 | 11,500 | 11,000 | 9,200 | | 90 |
| 95 | 63.6 | 164.6 | 14,800 | 14,000 | 13,200 | 12,500 | 67.6 | 159.7 | 11,400 | 11,300 | 11,000 | 9,200 | | 95 |
| 100 | 61.8 | 161.6 | 13,700 | 13,000 | 12,300 | 11,600 | 65.8 | 156.6 | 11,100 | 11,000 | 10,800 | 9,200 | | 100 |
| 105 | 59.9 | 158.4 | 12,700 | 12,000 | 11,400 | 10,800 | 63.8 | 153.3 | 10,900 | 10,700 | 10,600 | 9,200 | | 105 |
| 110 | 58.0 | 154.9 | 11,800 | 11,200 | 10,600 | 10,100 | 61.8 | 149.8 | 10,600 | 10,500 | 10,400 | 9,200 | | 110 |
| 115 | 56.0 | 151.3 | 11,000 | 10,400 | 9,900 | 9,400 | 59.8 | 145.9 | 10,400 | 10,300 | 10,200 | 9,200 | | 115 |
| 120 | 54.0 | 147.3 | 10,200 | 9,700 | 9,200 | 8,800 | 57.7 | 141.8 | 10,200 | 10,100 | 9,600 | 9,200 | | 120 |
| 125 | 52.0 | 143.0 | 9,500 | 9,100 | 8,600 | 8,200 | 55.6 | 137.4 | 9,900 | 9,400 | 9,000 | 8,600 | | 125 |
| 130 | 49.8 | 138.4 | 8,900 | 8,500 | 8,100 | 7,700 | 53.3 | 132.6 | 9,200 | 8,800 | 8,400 | 8,000 | | 130 |
| 135 | 47.6 | 133.5 | 8,300 | 7,900 | 7,600 | 7,200 | 51.0 | 127.4 | 8,600 | 8,200 | 7,800 | 7,500 | | 135 |
| 140 | 45.3 | 128.1 | 7,700 | 7,400 | 7,100 | 6,800 | 48.5 | 121.7 | 8,000 | 7,700 | 7,300 | 7,000 | | 140 |
| 145 | 42.9 | 122.3 | 7,200 | 6,900 | 6,600 | 6,300 | 46.0 | 115.5 | 7,500 | 7,100 | 6,800 | 6,500 | | 145 |
| 150 | 40.3 | 115.9 | 6,800 | 6,500 | 6,200 | 5,900 | 43.3 | 108.8 | 6,900 | 6,700 | 6,400 | 6,100 | | 150 |
| 155 | 37.6 | 108.9 | 6,300 | 6,100 | 5,800 | 5,600 | 40.3 | 101.2 | 6,500 | 6,200 | 6,000 | 5,700 | | 155 |
| 160 | 34.7 | 101.1 | 5,900 | 5,700 | 5,400 | 5,200 | 37.2 | 92.7 | 6,000 | 5,800 | 5,600 | 5,300 | | 160 |
| 165 | 31.5 | 92.3 | 5,500 | 5,300 | 5,100 | 4,900 | 33.6 | 83.0 | 5,600 | 5,400 | 5,200 | 5,000 | | 165 |
| 170 | 27.9 | 82.2 | 5,100 | 4,900 | 4,700 | 4,600 | | | | | | | | 170 |
| 175 | 23.8 | 70.0 | 4,800 | 4,600 | 4,400 | 4,300 | | | | | | | | 175 |

MLC90A-1 S-2



73,000 lb
+
23,100 lb

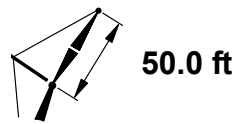
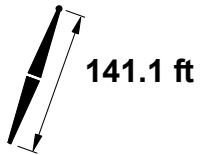

| | 10° | | | | | | | 30° | | | | | | |
|-----|------|-------|--------|--------|--------|--------|------|-------|--------|--------|--------|-------|----|-----|
| | | | | | | | | | | | | | | |
| | | | | | | | | | | | | | | |
| | | | | | | | | | | | | | | |
| | ft | ° | ft | lb | lb | lb | lb | ° | ft | lb | lb | lb | lb | ft |
| 46 | 80.8 | 193.9 | 22,100 | | | | | | | | | | | 46 |
| 48 | 80.2 | 193.5 | 22,000 | | | | | | | | | | | 48 |
| 50 | 79.6 | 193.0 | 22,000 | 18,700 | | | | | | | | | | 50 |
| 55 | 78.0 | 191.7 | 21,800 | 18,600 | 16,000 | | | | | | | | | 55 |
| 60 | 76.5 | 190.3 | 21,500 | 18,400 | 15,900 | 13,900 | | 80.6 | 185.8 | 14,200 | | | | 60 |
| 65 | 74.9 | 188.7 | 21,400 | 18,300 | 15,800 | 13,900 | 79.0 | 184.2 | 13,800 | 13,500 | | | | 65 |
| 70 | 73.3 | 187.0 | 21,200 | 18,200 | 15,600 | 13,800 | 77.4 | 182.4 | 13,300 | 13,100 | 10,900 | 9,100 | | 70 |
| 75 | 71.7 | 185.1 | 20,700 | 18,000 | 15,500 | 13,700 | 75.7 | 180.4 | 13,000 | 12,700 | 10,800 | 9,100 | | 75 |
| 80 | 70.1 | 183.0 | 18,900 | 17,600 | 15,500 | 13,600 | 74.1 | 178.3 | 12,600 | 12,400 | 10,800 | 9,100 | | 80 |
| 85 | 68.5 | 180.8 | 17,300 | 16,200 | 15,100 | 13,600 | 72.4 | 176.0 | 12,200 | 12,000 | 10,800 | 9,100 | | 85 |
| 90 | 66.8 | 178.4 | 15,800 | 14,900 | 14,000 | 13,100 | 70.7 | 173.6 | 11,900 | 11,700 | 10,800 | 9,100 | | 90 |
| 95 | 65.1 | 175.8 | 14,600 | 13,700 | 12,900 | 12,100 | 69.0 | 170.9 | 11,600 | 11,500 | 10,700 | 9,100 | | 95 |
| 100 | 63.4 | 173.0 | 13,500 | 12,700 | 12,000 | 11,300 | 67.2 | 168.1 | 11,300 | 11,200 | 10,700 | 9,100 | | 100 |
| 105 | 61.7 | 170.0 | 12,500 | 11,800 | 11,100 | 10,500 | 65.4 | 165.0 | 11,100 | 10,900 | 10,700 | 9,100 | | 105 |
| 110 | 59.9 | 166.9 | 11,500 | 10,900 | 10,300 | 9,700 | 63.6 | 161.7 | 10,800 | 10,700 | 10,600 | 9,100 | | 110 |
| 115 | 58.1 | 163.4 | 10,700 | 10,100 | 9,600 | 9,100 | 61.7 | 158.2 | 10,600 | 10,500 | 10,100 | 9,100 | | 115 |
| 120 | 56.2 | 159.8 | 10,000 | 9,400 | 8,900 | 8,500 | 59.8 | 154.4 | 10,400 | 9,900 | 9,400 | 8,900 | | 120 |
| 125 | 54.3 | 155.9 | 9,300 | 8,800 | 8,300 | 7,900 | 57.8 | 150.3 | 9,700 | 9,200 | 8,700 | 8,300 | | 125 |
| 130 | 52.4 | 151.7 | 8,600 | 8,200 | 7,800 | 7,400 | 55.8 | 146.0 | 9,000 | 8,600 | 8,100 | 7,700 | | 130 |
| 135 | 50.4 | 147.2 | 8,000 | 7,600 | 7,300 | 6,900 | 53.7 | 141.3 | 8,400 | 8,000 | 7,600 | 7,200 | | 135 |
| 140 | 48.3 | 142.4 | 7,500 | 7,100 | 6,800 | 6,400 | 51.5 | 136.3 | 7,800 | 7,400 | 7,100 | 6,700 | | 140 |
| 145 | 46.1 | 137.2 | 7,000 | 6,600 | 6,300 | 6,000 | 49.3 | 130.8 | 7,200 | 6,900 | 6,600 | 6,300 | | 145 |
| 150 | 43.9 | 131.6 | 6,500 | 6,200 | 5,900 | 5,600 | 46.9 | 124.9 | 6,700 | 6,400 | 6,100 | 5,800 | | 150 |
| 155 | 41.5 | 125.5 | 6,100 | 5,800 | 5,500 | 5,200 | 44.4 | 118.5 | 6,300 | 6,000 | 5,700 | 5,400 | | 155 |
| 160 | 39.0 | 118.9 | 5,600 | 5,400 | 5,100 | 4,900 | 41.7 | 111.4 | 5,800 | 5,600 | 5,300 | 5,100 | | 160 |
| 165 | 36.4 | 111.6 | 5,200 | 5,000 | 4,800 | 4,600 | 38.9 | 103.6 | 5,400 | 5,200 | 4,900 | 4,700 | | 165 |
| 170 | 33.6 | 103.5 | 4,900 | 4,700 | 4,400 | 4,200 | 35.8 | 94.7 | 5,000 | 4,800 | 4,600 | 4,300 | | 170 |
| 175 | 30.4 | 94.4 | 4,500 | 4,300 | 4,100 | 3,900 | 32.3 | 84.6 | 4,600 | 4,400 | 4,200 | 4,000 | | 175 |
| 180 | 27.0 | 83.9 | 4,200 | 4,000 | 3,800 | 3,700 | | | | | | | | 180 |
| 185 | 22.9 | 71.3 | 3,700 | 3,600 | 3,500 | 3,400 | | | | | | | | 185 |

MLC90A-1 S-2

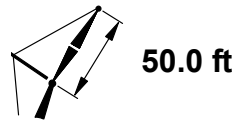
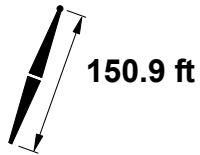
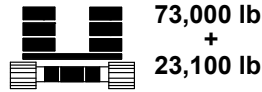
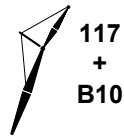

| | 10° | | | | | | | 30° | | | | | | | |
|-----|------|-------|--------|--------|--------|--------|------|-------|--------|--------|--------|-------|----|----|-----|
| | | | | | | | | | | | | | | | |
| | ft | ° | ft | 0° | 1° | 2° | 3° | ft | ° | ft | 0° | 1° | 2° | 3° | ft |
| 48 | 80.7 | 203.6 | 21,900 | | | | | | | | | | | | 48 |
| 50 | 80.1 | 203.1 | 21,800 | | | | | | | | | | | | 50 |
| 55 | 78.6 | 201.9 | 21,700 | 18,400 | 15,800 | | | | | | | | | | 55 |
| 60 | 77.2 | 200.5 | 21,500 | 18,300 | 15,700 | 13,000 | | | | | | | | | 60 |
| 65 | 75.7 | 199.0 | 21,300 | 18,200 | 15,600 | 13,000 | 79.6 | 194.4 | 13,900 | 13,200 | | | | | 65 |
| 70 | 74.2 | 197.4 | 21,100 | 18,100 | 15,600 | 13,000 | 78.1 | 192.8 | 13,500 | 13,100 | 10,700 | | | | 70 |
| 75 | 72.7 | 195.6 | 20,500 | 18,000 | 15,500 | 13,000 | 76.5 | 190.9 | 13,100 | 12,900 | 10,600 | 8,900 | | | 75 |
| 80 | 71.1 | 193.6 | 18,600 | 17,300 | 15,400 | 13,000 | 74.9 | 188.9 | 12,800 | 12,500 | 10,600 | 8,900 | | | 80 |
| 85 | 69.6 | 191.5 | 17,000 | 15,900 | 14,800 | 13,000 | 73.4 | 186.8 | 12,400 | 12,200 | 10,600 | 8,900 | | | 85 |
| 90 | 68.0 | 189.3 | 15,600 | 14,600 | 13,600 | 12,800 | 71.8 | 184.5 | 12,100 | 11,900 | 10,500 | 8,900 | | | 90 |
| 95 | 66.4 | 186.9 | 14,300 | 13,400 | 12,600 | 11,800 | 70.1 | 182.0 | 11,800 | 11,600 | 10,500 | 8,900 | | | 95 |
| 100 | 64.8 | 184.3 | 13,200 | 12,400 | 11,600 | 10,900 | 68.5 | 179.3 | 11,500 | 11,400 | 10,500 | 8,900 | | | 100 |
| 105 | 63.2 | 181.5 | 12,200 | 11,500 | 10,800 | 10,100 | 66.8 | 176.4 | 11,300 | 11,100 | 10,500 | 8,900 | | | 105 |
| 110 | 61.6 | 178.5 | 11,300 | 10,600 | 10,000 | 9,400 | 65.1 | 173.4 | 11,000 | 10,900 | 10,500 | 8,900 | | | 110 |
| 115 | 59.9 | 175.3 | 10,500 | 9,900 | 9,300 | 8,800 | 63.4 | 170.1 | 10,800 | 10,400 | 9,800 | 8,900 | | | 115 |
| 120 | 58.2 | 171.9 | 9,700 | 9,200 | 8,600 | 8,100 | 61.6 | 166.6 | 10,200 | 9,600 | 9,100 | 8,600 | | | 120 |
| 125 | 56.4 | 168.3 | 9,000 | 8,500 | 8,000 | 7,600 | 59.8 | 162.9 | 9,500 | 9,000 | 8,500 | 8,000 | | | 125 |
| 130 | 54.6 | 164.5 | 8,400 | 7,900 | 7,500 | 7,100 | 57.9 | 158.9 | 8,800 | 8,300 | 7,900 | 7,400 | | | 130 |
| 135 | 52.8 | 160.4 | 7,800 | 7,400 | 7,000 | 6,600 | 56.0 | 154.6 | 8,200 | 7,700 | 7,300 | 6,900 | | | 135 |
| 140 | 50.9 | 156.0 | 7,300 | 6,900 | 6,500 | 6,100 | 54.0 | 150.0 | 7,600 | 7,200 | 6,800 | 6,400 | | | 140 |
| 145 | 48.9 | 151.3 | 6,700 | 6,400 | 6,000 | 5,700 | 52.0 | 145.1 | 7,100 | 6,700 | 6,300 | 6,000 | | | 145 |
| 150 | 46.9 | 146.2 | 6,300 | 5,900 | 5,600 | 5,300 | 49.9 | 139.9 | 6,500 | 6,200 | 5,900 | 5,600 | | | 150 |
| 155 | 44.8 | 140.8 | 5,800 | 5,500 | 5,200 | 4,900 | 47.7 | 134.2 | 6,100 | 5,800 | 5,500 | 5,200 | | | 155 |
| 160 | 42.6 | 135.0 | 5,400 | 5,100 | 4,900 | 4,600 | 45.4 | 128.0 | 5,600 | 5,300 | 5,100 | 4,800 | | | 160 |
| 165 | 40.3 | 128.7 | 5,000 | 4,800 | 4,500 | 4,300 | 42.9 | 121.3 | 5,200 | 4,900 | 4,700 | 4,400 | | | 165 |
| 170 | 37.9 | 121.8 | 4,700 | 4,400 | 4,200 | 4,000 | 40.3 | 114.0 | 4,800 | 4,600 | 4,300 | 4,100 | | | 170 |
| 175 | 35.3 | 114.2 | 4,300 | 4,100 | 3,900 | 3,700 | 37.6 | 105.8 | 4,400 | 4,200 | 4,000 | 3,800 | | | 175 |
| 180 | 32.5 | 105.8 | 4,000 | 3,800 | 3,600 | 3,400 | 34.5 | 96.6 | 4,100 | 3,900 | 3,700 | 3,500 | | | 180 |
| 185 | 29.5 | 96.4 | 3,600 | 3,500 | 3,300 | 3,100 | 31.1 | 86.1 | 3,700 | 3,500 | 3,400 | 3,200 | | | 185 |
| 190 | 26.1 | 85.5 | 3,200 | 3,100 | 3,000 | 2,900 | | | | | | | | | 190 |
| 195 | 22.1 | 72.5 | 2,600 | 2,600 | 2,500 | 2,400 | | | | | | | | | 195 |

MLC90A-1 S-2

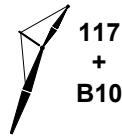

73,000 lb
+
23,100 lb

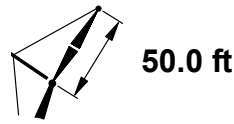
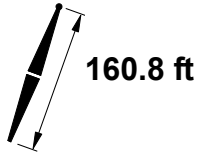

| | 10° | | | | | | | 30° | | | | | | | |
|-----|------|-------|--------|----------|----------|----------|----------|-------|--------|--------|----------|----------|----------|----------|-----|
| | | | | | | | | | | | | | | | |
| | ft | ° | ft | 0° lb | 1° lb | 2° lb | 3° lb | ft | ° | ft | 0° lb | 1° lb | 2° lb | 3° lb | ft |
| 50 | 80.6 | 213.2 | 21,600 | | | | | | | | | | | | 50 |
| 55 | 79.2 | 212.0 | 21,500 | 18,300 | | | | | | | | | | | 55 |
| 60 | 77.8 | 210.7 | 21,300 | 18,200 | 15,300 | 11,800 | | | | | | | | | 60 |
| 65 | 76.4 | 209.3 | 21,200 | 18,000 | 15,300 | 11,800 | 80.1 | 204.7 | 14,100 | | | | | | 65 |
| 70 | 74.9 | 207.7 | 21,000 | 17,900 | 15,200 | 11,700 | 78.6 | 203.1 | 13,700 | 12,800 | 10,400 | | | | 70 |
| 75 | 73.5 | 206.0 | 20,200 | 17,800 | 15,200 | 11,700 | 77.2 | 201.3 | 13,300 | 12,800 | 10,400 | 8,700 | | | 75 |
| 80 | 72.1 | 204.2 | 18,400 | 17,000 | 15,200 | 11,700 | 75.7 | 199.5 | 12,900 | 12,700 | 10,400 | 8,700 | | | 80 |
| 85 | 70.6 | 202.2 | 16,800 | 15,600 | 14,500 | 11,600 | 74.2 | 197.4 | 12,600 | 12,400 | 10,400 | 8,700 | | | 85 |
| 90 | 69.1 | 200.1 | 15,400 | 14,300 | 13,300 | 11,600 | 72.7 | 195.2 | 12,300 | 12,100 | 10,400 | 8,700 | | | 90 |
| 95 | 67.6 | 197.8 | 14,100 | 13,100 | 12,300 | 11,400 | 71.2 | 192.9 | 12,000 | 11,800 | 10,300 | 8,700 | | | 95 |
| 100 | 66.1 | 195.3 | 13,000 | 12,100 | 11,300 | 10,600 | 69.6 | 190.4 | 11,700 | 11,600 | 10,300 | 8,700 | | | 100 |
| 105 | 64.6 | 192.7 | 12,000 | 11,200 | 10,500 | 9,800 | 68.0 | 187.7 | 11,500 | 11,300 | 10,300 | 8,700 | | | 105 |
| 110 | 63.0 | 189.9 | 11,000 | 10,300 | 9,700 | 9,100 | 66.4 | 184.8 | 11,200 | 11,000 | 10,300 | 8,700 | | | 110 |
| 115 | 61.5 | 187.0 | 10,200 | 9,600 | 9,000 | 8,400 | 64.8 | 181.8 | 10,800 | 10,100 | 9,500 | 8,700 | | | 115 |
| 120 | 59.9 | 183.8 | 9,500 | 8,900 | 8,300 | 7,800 | 63.2 | 178.5 | 10,000 | 9,400 | 8,800 | 8,300 | | | 120 |
| 125 | 58.2 | 180.4 | 8,800 | 8,200 | 7,700 | 7,200 | 61.5 | 175.0 | 9,300 | 8,700 | 8,200 | 7,700 | | | 125 |
| 130 | 56.5 | 176.9 | 8,100 | 7,600 | 7,200 | 6,700 | 59.8 | 171.3 | 8,600 | 8,100 | 7,600 | 7,200 | | | 130 |
| 135 | 54.8 | 173.1 | 7,500 | 7,100 | 6,700 | 6,300 | 58.0 | 167.4 | 8,000 | 7,500 | 7,100 | 6,600 | | | 135 |
| 140 | 53.1 | 169.0 | 7,000 | 6,600 | 6,200 | 5,800 | 56.2 | 163.2 | 7,400 | 7,000 | 6,500 | 6,200 | | | 140 |
| 145 | 51.3 | 164.7 | 6,500 | 6,100 | 5,700 | 5,400 | 54.3 | 158.7 | 6,800 | 6,400 | 6,100 | 5,700 | | | 145 |
| 150 | 49.5 | 160.1 | 6,000 | 5,700 | 5,300 | 5,000 | 52.4 | 153.9 | 6,300 | 6,000 | 5,600 | 5,300 | | | 150 |
| 155 | 47.6 | 155.2 | 5,600 | 5,200 | 4,900 | 4,600 | 50.4 | 148.8 | 5,900 | 5,500 | 5,200 | 4,900 | | | 155 |
| 160 | 45.6 | 149.9 | 5,200 | 4,900 | 4,600 | 4,300 | 48.4 | 143.3 | 5,400 | 5,100 | 4,800 | 4,500 | | | 160 |
| 165 | 43.6 | 144.3 | 4,800 | 4,500 | 4,200 | 4,000 | 46.2 | 137.4 | 5,000 | 4,700 | 4,400 | 4,200 | | | 165 |
| 170 | 41.4 | 138.2 | 4,400 | 4,100 | 3,900 | 3,600 | 44.0 | 131.0 | 4,600 | 4,300 | 4,100 | 3,800 | | | 170 |
| 175 | 39.2 | 131.7 | 4,100 | 3,800 | 3,600 | 3,400 | 41.6 | 124.1 | 4,200 | 4,000 | 3,700 | 3,500 | | | 175 |
| 180 | 36.8 | 124.6 | 3,700 | 3,500 | 3,300 | 3,100 | 39.1 | 116.4 | 3,900 | 3,600 | 3,400 | 3,200 | | | 180 |
| 185 | 34.3 | 116.7 | 3,400 | 3,200 | 3,000 | 2,800 | 36.3 | 108.0 | 3,500 | 3,300 | 3,100 | 2,900 | | | 185 |
| 190 | 31.6 | 108.1 | 3,000 | 2,900 | 2,700 | 2,600 | 33.4 | 98.5 | 3,200 | 3,000 | 2,800 | 2,600 | | | 190 |
| 195 | 28.6 | 98.3 | 2,600 | 2,500 | 2,400 | 2,300 | | | | | | | | | 195 |
| 200 | 25.3 | 87.1 | 2,100 | 2,100 | 2,000 | | | | | | | | | | 200 |

MLC90A-1 S-2

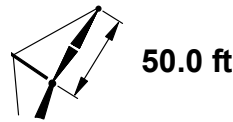
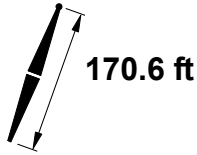
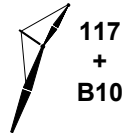

| | 10° | | | | | | | 30° | | | | | | |
|-----|------|-------|--------|----------|----------|----------|----------|------|-------|----------|----------|----------|----------|-----|
| | | | | | | | | | | | | | | |
| | ft | ° | ft | 0° lb | 1° lb | 2° lb | 3° lb | ° | ft | 0° lb | 1° lb | 2° lb | 3° lb | ft |
| 50 | 81.0 | 223.2 | 21,400 | | | | | | | | | | | 50 |
| 55 | 79.7 | 222.1 | 21,300 | 18,000 | | | | | | | | | | 55 |
| 60 | 78.3 | 220.9 | 21,200 | 17,900 | 13,900 | | | | | | | | | 60 |
| 65 | 77.0 | 219.5 | 21,000 | 17,800 | 13,900 | 10,500 | | 80.6 | 214.9 | 14,200 | | | | 65 |
| 70 | 75.6 | 218.0 | 20,900 | 17,700 | 13,800 | 10,500 | | 79.2 | 213.4 | 13,800 | 12,600 | | | 70 |
| 75 | 74.3 | 216.4 | 20,000 | 17,600 | 13,800 | 10,500 | | 77.8 | 211.7 | 13,400 | 12,500 | 10,200 | 8,400 | 75 |
| 80 | 72.9 | 214.7 | 18,200 | 16,700 | 13,700 | 10,400 | | 76.4 | 209.9 | 13,100 | 12,500 | 10,200 | 8,400 | 80 |
| 85 | 71.5 | 212.8 | 16,500 | 15,300 | 13,700 | 10,400 | | 75.0 | 208.0 | 12,800 | 12,400 | 10,200 | 8,400 | 85 |
| 90 | 70.1 | 210.8 | 15,100 | 14,000 | 13,000 | 10,300 | | 73.5 | 205.9 | 12,500 | 12,300 | 10,200 | 8,400 | 90 |
| 95 | 68.7 | 208.6 | 13,900 | 12,900 | 12,000 | 10,300 | | 72.1 | 203.7 | 12,200 | 12,000 | 10,100 | 8,400 | 95 |
| 100 | 67.3 | 206.3 | 12,700 | 11,900 | 11,000 | 10,300 | | 70.6 | 201.3 | 11,900 | 11,700 | 10,100 | 8,400 | 100 |
| 105 | 65.8 | 203.8 | 11,700 | 10,900 | 10,200 | 9,500 | | 69.1 | 198.8 | 11,600 | 11,500 | 10,100 | 8,400 | 105 |
| 110 | 64.4 | 201.2 | 10,800 | 10,100 | 9,400 | 8,800 | | 67.6 | 196.1 | 11,400 | 10,700 | 10,000 | 8,400 | 110 |
| 115 | 62.9 | 198.4 | 10,000 | 9,300 | 8,700 | 8,100 | | 66.1 | 193.2 | 10,600 | 9,900 | 9,300 | 8,400 | 115 |
| 120 | 61.4 | 195.4 | 9,200 | 8,600 | 8,100 | 7,500 | | 64.6 | 190.2 | 9,800 | 9,200 | 8,600 | 8,000 | 120 |
| 125 | 59.8 | 192.3 | 8,600 | 8,000 | 7,500 | 7,000 | | 63.0 | 186.9 | 9,100 | 8,500 | 8,000 | 7,500 | 125 |
| 130 | 58.3 | 188.9 | 7,900 | 7,400 | 6,900 | 6,500 | | 61.4 | 183.5 | 8,400 | 7,900 | 7,400 | 6,900 | 130 |
| 135 | 56.7 | 185.4 | 7,300 | 6,900 | 6,400 | 6,000 | | 59.7 | 179.8 | 7,800 | 7,300 | 6,800 | 6,400 | 135 |
| 140 | 55.1 | 181.6 | 6,800 | 6,300 | 5,900 | 5,500 | | 58.1 | 175.9 | 7,200 | 6,800 | 6,300 | 5,900 | 140 |
| 145 | 53.4 | 177.6 | 6,300 | 5,900 | 5,500 | 5,100 | | 56.3 | 171.8 | 6,700 | 6,200 | 5,900 | 5,500 | 145 |
| 150 | 51.7 | 173.4 | 5,800 | 5,400 | 5,100 | 4,700 | | 54.6 | 167.4 | 6,200 | 5,800 | 5,400 | 5,100 | 150 |
| 155 | 50.0 | 168.9 | 5,400 | 5,000 | 4,700 | 4,400 | | 52.8 | 162.7 | 5,700 | 5,300 | 5,000 | 4,700 | 155 |
| 160 | 48.2 | 164.1 | 4,900 | 4,600 | 4,300 | 4,000 | | 50.9 | 157.7 | 5,200 | 4,900 | 4,600 | 4,300 | 160 |
| 165 | 46.3 | 159.0 | 4,600 | 4,300 | 4,000 | 3,700 | | 49.0 | 152.4 | 4,800 | 4,500 | 4,200 | 3,900 | 165 |
| 170 | 44.4 | 153.5 | 4,200 | 3,900 | 3,700 | 3,400 | | 47.0 | 146.7 | 4,400 | 4,200 | 3,900 | 3,600 | 170 |
| 175 | 42.4 | 147.7 | 3,900 | 3,600 | 3,300 | 3,100 | | 44.9 | 140.6 | 4,100 | 3,800 | 3,500 | 3,300 | 175 |
| 180 | 40.3 | 141.4 | 3,500 | 3,300 | 3,100 | 2,800 | | 42.7 | 133.9 | 3,700 | 3,500 | 3,200 | 3,000 | 180 |
| 185 | 38.1 | 134.6 | 3,200 | 3,000 | 2,800 | 2,600 | | 40.3 | 126.7 | 3,400 | 3,100 | 2,900 | 2,700 | 185 |
| 190 | 35.8 | 127.3 | 2,900 | 2,700 | 2,500 | 2,300 | | 37.9 | 118.8 | 3,100 | 2,800 | 2,600 | 2,400 | 190 |
| 195 | 33.4 | 119.2 | 2,500 | 2,400 | 2,200 | 2,100 | | 35.2 | 110.1 | 2,700 | 2,500 | 2,400 | 2,200 | 195 |
| 200 | 30.7 | 110.2 | 2,100 | 2,000 | | | | 32.3 | 100.3 | 2,200 | 2,100 | 2,000 | | 200 |

MLC90A-1 S-2

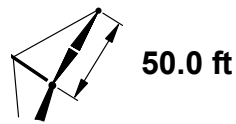
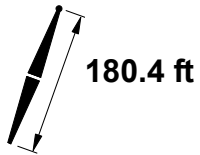

| | 10° | | | | | | | 30° | | | | | | | |
|-----|------|-------|--------|--------|--------|-------|------|-------|--------|--------|--------|-------|----|-----|--|
| | | | 0° | | | | | | | | 0° | | | | |
| | ft | ° | lb | lb | lb | lb | ° | ft | lb | lb | lb | lb | ft | | |
| 55 | 80.1 | 232.2 | 21,000 | | | | | | | | | | | 55 | |
| 60 | 78.8 | 231.0 | 20,900 | 16,600 | 12,500 | | | | | | | | | 60 | |
| 65 | 77.6 | 229.7 | 20,700 | 16,600 | 12,400 | 9,300 | 81.0 | 225.0 | 14,300 | | | | | 65 | |
| 70 | 76.3 | 228.3 | 20,700 | 16,600 | 12,400 | 9,300 | 79.7 | 223.6 | 13,900 | 12,300 | | | | 70 | |
| 75 | 75.0 | 226.8 | 19,800 | 16,500 | 12,300 | 9,300 | 78.3 | 222.0 | 13,600 | 12,200 | 10,000 | | | 75 | |
| 80 | 73.7 | 225.1 | 17,900 | 16,400 | 12,300 | 9,200 | 77.0 | 220.3 | 13,200 | 12,200 | 10,000 | 7,500 | | 80 | |
| 85 | 72.3 | 223.3 | 16,300 | 15,000 | 12,200 | 9,200 | 75.7 | 218.5 | 12,900 | 12,100 | 10,000 | 7,500 | | 85 | |
| 90 | 71.0 | 221.4 | 14,900 | 13,700 | 12,100 | 9,100 | 74.3 | 216.5 | 12,600 | 12,100 | 10,000 | 7,500 | | 90 | |
| 95 | 69.7 | 219.3 | 13,600 | 12,600 | 11,600 | 9,100 | 72.9 | 214.4 | 12,300 | 12,000 | 9,900 | 7,400 | | 95 | |
| 100 | 68.3 | 217.1 | 12,500 | 11,600 | 10,700 | 9,100 | 71.5 | 212.2 | 12,100 | 11,900 | 9,900 | 7,400 | | 100 | |
| 105 | 66.9 | 214.8 | 11,500 | 10,600 | 9,900 | 9,100 | 70.1 | 209.8 | 11,800 | 11,400 | 9,900 | 7,400 | | 105 | |
| 110 | 65.6 | 212.3 | 10,600 | 9,800 | 9,100 | 8,400 | 68.7 | 207.2 | 11,300 | 10,500 | 9,800 | 7,400 | | 110 | |
| 115 | 64.2 | 209.7 | 9,700 | 9,100 | 8,400 | 7,800 | 67.3 | 204.5 | 10,400 | 9,700 | 9,000 | 7,300 | | 115 | |
| 120 | 62.7 | 206.9 | 9,000 | 8,400 | 7,800 | 7,200 | 65.8 | 201.6 | 9,600 | 8,900 | 8,300 | 7,300 | | 120 | |
| 125 | 61.3 | 203.9 | 8,300 | 7,700 | 7,200 | 6,600 | 64.3 | 198.6 | 8,900 | 8,300 | 7,700 | 7,200 | | 125 | |
| 130 | 59.8 | 200.8 | 7,700 | 7,100 | 6,600 | 6,100 | 62.8 | 195.3 | 8,200 | 7,600 | 7,100 | 6,600 | | 130 | |
| 135 | 58.3 | 197.4 | 7,100 | 6,600 | 6,100 | 5,700 | 61.3 | 191.9 | 7,600 | 7,000 | 6,600 | 6,100 | | 135 | |
| 140 | 56.8 | 193.9 | 6,500 | 6,100 | 5,600 | 5,200 | 59.7 | 188.3 | 7,000 | 6,500 | 6,100 | 5,600 | | 140 | |
| 145 | 55.3 | 190.2 | 6,000 | 5,600 | 5,200 | 4,800 | 58.1 | 184.4 | 6,400 | 6,000 | 5,600 | 5,200 | | 145 | |
| 150 | 53.7 | 186.2 | 5,500 | 5,200 | 4,800 | 4,400 | 56.5 | 180.4 | 5,900 | 5,500 | 5,100 | 4,800 | | 150 | |
| 155 | 52.1 | 182.1 | 5,100 | 4,700 | 4,400 | 4,100 | 54.8 | 176.1 | 5,500 | 5,100 | 4,700 | 4,400 | | 155 | |
| 160 | 50.4 | 177.6 | 4,700 | 4,400 | 4,000 | 3,700 | 53.1 | 171.5 | 5,000 | 4,700 | 4,300 | 4,000 | | 160 | |
| 165 | 48.7 | 173.0 | 4,300 | 4,000 | 3,700 | 3,400 | 51.3 | 166.6 | 4,600 | 4,300 | 4,000 | 3,700 | | 165 | |
| 170 | 47.0 | 168.0 | 3,900 | 3,600 | 3,400 | 3,100 | 49.5 | 161.4 | 4,200 | 3,900 | 3,600 | 3,300 | | 170 | |
| 175 | 45.1 | 162.7 | 3,600 | 3,300 | 3,100 | 2,800 | 47.6 | 155.9 | 3,800 | 3,600 | 3,300 | 3,000 | | 175 | |
| 180 | 43.3 | 157.0 | 3,300 | 3,000 | 2,800 | 2,500 | 45.7 | 150.0 | 3,500 | 3,200 | 3,000 | 2,700 | | 180 | |
| 185 | 41.3 | 151.0 | 3,000 | 2,700 | 2,500 | 2,300 | 43.6 | 143.6 | 3,200 | 2,900 | 2,700 | 2,400 | | 185 | |
| 190 | 39.3 | 144.5 | 2,700 | 2,400 | 2,200 | 2,000 | 41.5 | 136.7 | 2,800 | 2,600 | 2,400 | 2,200 | | 190 | |
| 195 | 37.2 | 137.5 | 2,300 | 2,100 | 2,000 | | 39.2 | 129.3 | 2,500 | 2,300 | 2,100 | | | 195 | |
| 200 | | | | | | | 36.8 | 121.1 | 2,100 | | | | | 200 | |

MLC90A-1 S-2

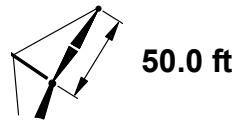
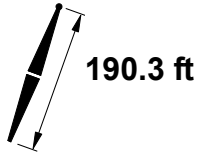
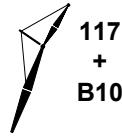

| | 10° | | | | | | | 30° | | | | | | | |
|-----|------|-------|--------|----------|----------|----------|----------|-------|--------|--------|----------|----------|----------|----------|-----|
| | | | | | | | | | | | | | | | |
| | ft | ° | ft | 0° lb | 1° lb | 2° lb | 3° lb | ft | ° | ft | 0° lb | 1° lb | 2° lb | 3° lb | ft |
| 55 | 80.5 | 242.3 | 20,600 | | | | | | | | | | | | 55 |
| 60 | 79.3 | 241.1 | 20,400 | 15,000 | | | | | | | | | | | 60 |
| 65 | 78.1 | 239.9 | 20,100 | 14,900 | 11,000 | | | | | | | | | | 65 |
| 70 | 76.8 | 238.6 | 19,900 | 14,900 | 10,900 | 8,200 | | 80.1 | 233.8 | 14,100 | | | | | 70 |
| 75 | 75.6 | 237.1 | 19,500 | 14,800 | 10,900 | 8,100 | | 78.9 | 232.3 | 13,700 | 12,000 | 8,900 | | | 75 |
| 80 | 74.4 | 235.5 | 17,600 | 14,800 | 10,900 | 8,100 | 77.6 | 230.7 | 13,400 | 11,900 | 8,800 | 6,500 | | | 80 |
| 85 | 73.1 | 233.8 | 16,000 | 14,700 | 10,800 | 8,100 | 76.3 | 228.9 | 13,100 | 11,700 | 8,800 | 6,500 | | | 85 |
| 90 | 71.8 | 232.0 | 14,600 | 13,400 | 10,800 | 8,100 | 75.0 | 227.0 | 12,800 | 11,500 | 8,800 | 6,500 | | | 90 |
| 95 | 70.5 | 230.0 | 13,400 | 12,300 | 10,800 | 8,100 | 73.7 | 225.0 | 12,500 | 11,400 | 8,800 | 6,500 | | | 95 |
| 100 | 69.3 | 227.9 | 12,200 | 11,300 | 10,400 | 8,100 | 72.4 | 222.9 | 12,200 | 11,200 | 8,800 | 6,500 | | | 100 |
| 105 | 68.0 | 225.7 | 11,200 | 10,300 | 9,500 | 8,000 | 71.0 | 220.6 | 12,000 | 11,100 | 8,800 | 6,500 | | | 105 |
| 110 | 66.6 | 223.3 | 10,300 | 9,500 | 8,800 | 8,000 | 69.7 | 218.2 | 11,000 | 10,200 | 8,800 | 6,500 | | | 110 |
| 115 | 65.3 | 220.8 | 9,500 | 8,700 | 8,100 | 7,400 | 68.3 | 215.6 | 10,200 | 9,400 | 8,700 | 6,500 | | | 115 |
| 120 | 64.0 | 218.1 | 8,700 | 8,000 | 7,400 | 6,800 | 66.9 | 212.9 | 9,400 | 8,700 | 8,000 | 6,500 | | | 120 |
| 125 | 62.6 | 215.3 | 8,000 | 7,400 | 6,800 | 6,300 | 65.5 | 210.0 | 8,600 | 8,000 | 7,400 | 6,400 | | | 125 |
| 130 | 61.2 | 212.4 | 7,400 | 6,800 | 6,300 | 5,800 | 64.1 | 207.0 | 7,900 | 7,400 | 6,800 | 6,300 | | | 130 |
| 135 | 59.8 | 209.2 | 6,800 | 6,300 | 5,800 | 5,300 | 62.7 | 203.8 | 7,300 | 6,800 | 6,300 | 5,800 | | | 135 |
| 140 | 58.4 | 205.9 | 6,200 | 5,800 | 5,300 | 4,900 | 61.2 | 200.4 | 6,700 | 6,200 | 5,800 | 5,300 | | | 140 |
| 145 | 56.9 | 202.4 | 5,700 | 5,300 | 4,900 | 4,500 | 59.7 | 196.8 | 6,200 | 5,700 | 5,300 | 4,900 | | | 145 |
| 150 | 55.4 | 198.7 | 5,300 | 4,900 | 4,500 | 4,100 | 58.2 | 193.0 | 5,700 | 5,300 | 4,900 | 4,500 | | | 150 |
| 155 | 53.9 | 194.8 | 4,800 | 4,400 | 4,100 | 3,700 | 56.6 | 188.9 | 5,200 | 4,800 | 4,400 | 4,100 | | | 155 |
| 160 | 52.4 | 190.7 | 4,400 | 4,100 | 3,700 | 3,400 | 55.0 | 184.7 | 4,800 | 4,400 | 4,100 | 3,700 | | | 160 |
| 165 | 50.8 | 186.4 | 4,000 | 3,700 | 3,400 | 3,100 | 53.4 | 180.2 | 4,400 | 4,000 | 3,700 | 3,400 | | | 165 |
| 170 | 49.2 | 181.8 | 3,700 | 3,300 | 3,000 | 2,800 | 51.7 | 175.4 | 4,000 | 3,600 | 3,300 | 3,000 | | | 170 |
| 175 | 47.5 | 176.9 | 3,300 | 3,000 | 2,700 | 2,500 | 50.0 | 170.4 | 3,600 | 3,300 | 3,000 | 2,700 | | | 175 |
| 180 | 45.8 | 171.7 | 3,000 | 2,700 | 2,500 | 2,200 | 48.2 | 165.0 | 3,200 | 3,000 | 2,700 | 2,400 | | | 180 |
| 185 | 44.1 | 166.3 | 2,700 | 2,400 | 2,200 | | 46.4 | 159.3 | 2,900 | 2,700 | 2,400 | 2,200 | | | 185 |
| 190 | 42.2 | 160.4 | 2,400 | 2,200 | | | 44.5 | 153.1 | 2,600 | 2,400 | 2,100 | | | | 190 |
| 195 | 40.3 | 154.2 | 2,000 | | | | 42.5 | 146.5 | 2,300 | 2,100 | | | | | 195 |

MLC90A-1 S-2

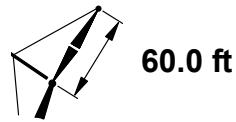
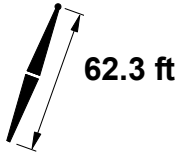
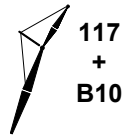

| | | | 10° | | | | 30° | | | | | | | |
|-----|------|-------|--------|--------|--------|--------|------|-------|--------|--------|--------|-------|-----|--|
| | | | | | | | | | | | | | | |
| | | | 0° | 1° | 2° | 3° | | | 0° | 1° | 2° | 3° | | |
| ft | ° | ft | lb | lb | lb | lb | ° | ft | lb | lb | lb | lb | ft | |
| 36 | 80.7 | 126.0 | 20,600 | | | | | | | | | | 36 | |
| 38 | 79.7 | 125.4 | 20,300 | 17,300 | | | | | | | | | 38 | |
| 40 | 78.7 | 124.8 | 20,200 | 17,200 | 14,600 | | | | | | | | 40 | |
| 42 | 77.8 | 124.2 | 20,000 | 17,000 | 14,500 | 12,700 | | | | | | | 42 | |
| 44 | 76.8 | 123.5 | 19,800 | 16,900 | 14,400 | 12,600 | | | | | | | 44 | |
| 46 | 75.8 | 122.9 | 19,600 | 16,700 | 14,300 | 12,500 | | | | | | | 46 | |
| 48 | 74.8 | 122.1 | 19,400 | 16,600 | 14,200 | 12,500 | | | | | | | 48 | |
| 50 | 73.8 | 121.3 | 19,300 | 16,500 | 14,100 | 12,400 | | | | | | | 50 | |
| 55 | 71.3 | 119.2 | 18,800 | 16,200 | 13,900 | 12,200 | 79.3 | 115.6 | 12,500 | 11,900 | | | 55 | |
| 60 | 68.7 | 116.9 | 18,400 | 15,900 | 13,700 | 12,100 | 76.6 | 113.1 | 11,800 | 11,300 | 10,000 | 9,000 | 60 | |
| 65 | 66.1 | 114.2 | 18,000 | 15,600 | 13,500 | 11,900 | 73.9 | 110.3 | 11,200 | 10,800 | 9,700 | 8,600 | 65 | |
| 70 | 63.4 | 111.2 | 16,800 | 15,300 | 13,300 | 11,700 | 71.1 | 107.2 | 10,700 | 10,400 | 9,300 | 8,400 | 70 | |
| 75 | 60.6 | 107.9 | 15,600 | 15,000 | 13,100 | 11,600 | 68.2 | 103.8 | 10,200 | 9,900 | 9,000 | 8,200 | 75 | |
| 80 | 57.7 | 104.2 | 14,600 | 14,200 | 12,900 | 11,400 | 65.1 | 100.0 | 9,800 | 9,600 | 8,700 | 7,900 | 80 | |
| 85 | 54.7 | 100.1 | 13,600 | 13,400 | 12,700 | 11,300 | 62.0 | 95.7 | 9,400 | 9,200 | 8,400 | 7,600 | 85 | |
| 90 | 51.5 | 95.6 | 12,800 | 12,600 | 12,400 | 11,200 | 58.7 | 90.9 | 9,000 | 8,900 | 8,100 | 7,400 | 90 | |
| 95 | 48.2 | 90.5 | 12,100 | 11,900 | 11,700 | 11,100 | 55.1 | 85.5 | 8,700 | 8,600 | 7,900 | 7,200 | 95 | |
| 100 | 44.6 | 84.7 | 11,500 | 11,400 | 11,200 | 11,000 | 51.4 | 79.3 | 8,400 | 8,300 | 7,600 | 7,100 | 100 | |
| 105 | 40.8 | 78.2 | 11,000 | 10,800 | 10,700 | 10,600 | 47.2 | 72.2 | 8,100 | 8,100 | 7,500 | 6,900 | 105 | |
| 110 | 36.5 | 70.5 | 10,400 | 10,300 | 10,300 | 10,200 | 42.5 | 63.8 | 7,900 | 7,900 | 7,300 | 6,800 | 110 | |
| 115 | 31.7 | 61.4 | 10,100 | 10,000 | 9,900 | 9,800 | 37.0 | 53.3 | 7,800 | 7,700 | 7,200 | 6,700 | 115 | |
| 120 | 25.8 | 49.8 | 9,800 | 9,700 | 9,600 | 9,500 | 29.6 | 38.9 | 7,700 | 7,600 | 7,200 | 6,700 | 120 | |

MLC90A-1 S-2

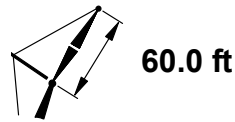
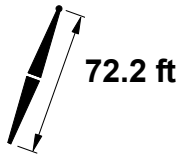
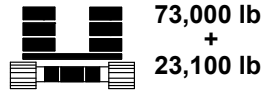
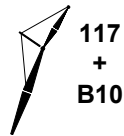

| | 10° | | | | | | 30° | | | | | | | | |
|-----|------|-------|--------|----------|----------|----------|----------|-------|--------|--------|----------|----------|--|----------|----------|
| | | | | | | | | | | | | | | | |
| | ft | ° | ft | 0° lb | 1° lb | 2° lb | 3° lb | ft | ° | ft | 0° lb | 1° lb | | 2° lb | 3° lb |
| 38 | 80.5 | 135.6 | 20,500 | | | | | | | | | | | | 38 |
| 40 | 79.6 | 135.0 | 20,300 | 17,200 | | | | | | | | | | | 40 |
| 42 | 78.7 | 134.5 | 20,100 | 17,000 | 14,600 | | | | | | | | | | 42 |
| 44 | 77.8 | 133.8 | 19,900 | 17,000 | 14,500 | 12,600 | | | | | | | | | 44 |
| 46 | 76.9 | 133.2 | 19,800 | 16,800 | 14,300 | 12,500 | | | | | | | | | 46 |
| 48 | 76.0 | 132.5 | 19,600 | 16,700 | 14,200 | 12,500 | | | | | | | | | 48 |
| 50 | 75.1 | 131.8 | 19,400 | 16,600 | 14,200 | 12,500 | | | | | | | | | 50 |
| 55 | 72.8 | 129.9 | 19,000 | 16,300 | 14,000 | 12,200 | 80.2 | 126.0 | 12,800 | | | | | | 55 |
| 60 | 70.4 | 127.7 | 18,600 | 16,100 | 13,800 | 12,100 | 77.7 | 123.8 | 12,100 | 11,900 | 11,100 | 9,100 | | | 60 |
| 65 | 68.0 | 125.3 | 18,300 | 15,800 | 13,600 | 11,900 | 75.3 | 121.3 | 11,500 | 11,300 | 10,800 | 9,100 | | | 65 |
| 70 | 65.6 | 122.6 | 17,900 | 15,600 | 13,400 | 11,800 | 72.7 | 118.5 | 11,000 | 10,800 | 10,400 | 9,100 | | | 70 |
| 75 | 63.1 | 119.6 | 17,600 | 15,300 | 13,300 | 11,700 | 70.1 | 115.4 | 10,500 | 10,400 | 10,200 | 9,100 | | | 75 |
| 80 | 60.5 | 116.4 | 17,200 | 15,100 | 13,100 | 11,500 | 67.4 | 112.0 | 10,100 | 9,900 | 9,800 | 8,900 | | | 80 |
| 85 | 57.8 | 112.7 | 16,800 | 14,800 | 12,900 | 11,400 | 64.7 | 108.2 | 9,700 | 9,600 | 9,400 | 8,600 | | | 85 |
| 90 | 55.1 | 108.8 | 16,100 | 14,600 | 12,800 | 11,300 | 61.8 | 104.0 | 9,300 | 9,200 | 9,100 | 8,400 | | | 90 |
| 95 | 52.2 | 104.3 | 15,200 | 14,400 | 12,700 | 11,300 | 58.7 | 99.4 | 9,000 | 8,900 | 8,800 | 8,200 | | | 95 |
| 100 | 49.2 | 99.5 | 14,400 | 14,200 | 12,500 | 11,100 | 55.6 | 94.2 | 8,700 | 8,600 | 8,600 | 8,000 | | | 100 |
| 105 | 46.0 | 94.0 | 13,700 | 13,500 | 12,400 | 11,000 | 52.2 | 88.4 | 8,500 | 8,400 | 8,300 | 7,900 | | | 105 |
| 110 | 42.6 | 87.9 | 13,100 | 12,900 | 12,300 | 10,900 | 48.5 | 81.9 | 8,200 | 8,200 | 8,100 | 7,700 | | | 110 |
| 115 | 38.9 | 80.9 | 12,500 | 12,100 | 11,800 | 10,900 | 44.5 | 74.3 | 8,000 | 8,000 | 7,900 | 7,600 | | | 115 |
| 120 | 34.8 | 72.8 | 11,700 | 11,400 | 11,100 | 10,800 | 39.9 | 65.3 | 7,800 | 7,800 | 7,800 | 7,500 | | | 120 |
| 125 | 30.1 | 63.2 | 11,000 | 10,800 | 10,500 | 10,200 | 34.5 | 54.1 | 7,700 | 7,700 | 7,700 | 7,500 | | | 125 |
| 130 | 24.4 | 50.9 | 10,400 | 10,100 | 9,900 | 9,700 | | | | | | | | | 130 |

MLC90A-1 S-2

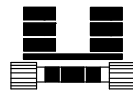
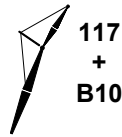

73,000 lb
+
23,100 lb



360°

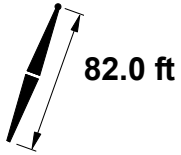

82.0 ft

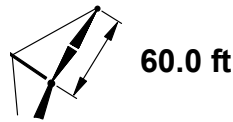

60.0 ft

| | 10° | | | | | | | 30° | | | | | | | |
|-----|------|-------|--------|----------|----------|----------|----------|-------|--------|--------|----------|----------|----------|----------|-----|
| | | | | | | | | | | | | | | | |
| | ft | ° | ft | 0° lb | 1° lb | 2° lb | 3° lb | ft | ° | ft | 0° lb | 1° lb | 2° lb | 3° lb | ft |
| 40 | 80.3 | 145.2 | 20,400 | | | | | | | | | | | | 40 |
| 42 | 79.5 | 144.6 | 20,200 | 17,100 | | | | | | | | | | | 42 |
| 44 | 78.7 | 144.1 | 20,100 | 17,000 | 14,400 | | | | | | | | | | 44 |
| 46 | 77.8 | 143.5 | 19,900 | 16,900 | 14,400 | 12,600 | | | | | | | | | 46 |
| 48 | 77.0 | 142.9 | 19,700 | 16,800 | 14,300 | 12,500 | | | | | | | | | 48 |
| 50 | 76.2 | 142.2 | 19,600 | 16,700 | 14,200 | 12,400 | | | | | | | | | 50 |
| 55 | 74.0 | 140.4 | 19,200 | 16,400 | 14,000 | 12,300 | 80.9 | 136.4 | 13,000 | | | | | | 55 |
| 60 | 71.9 | 138.4 | 18,800 | 16,200 | 13,900 | 12,100 | 78.7 | 134.3 | 12,300 | 12,100 | 10,700 | | | | 60 |
| 65 | 69.7 | 136.2 | 18,500 | 15,900 | 13,700 | 12,000 | 76.4 | 132.0 | 11,800 | 11,500 | 10,700 | 8,800 | | | 65 |
| 70 | 67.4 | 133.8 | 18,200 | 15,700 | 13,600 | 11,900 | 74.1 | 129.5 | 11,300 | 11,100 | 10,700 | 8,800 | | | 70 |
| 75 | 65.1 | 131.1 | 17,800 | 15,500 | 13,400 | 11,800 | 71.7 | 126.7 | 10,800 | 10,600 | 10,500 | 8,800 | | | 75 |
| 80 | 62.8 | 128.1 | 17,500 | 15,300 | 13,300 | 11,700 | 69.3 | 123.6 | 10,400 | 10,200 | 10,100 | 8,800 | | | 80 |
| 85 | 60.4 | 124.8 | 17,100 | 15,000 | 13,100 | 11,600 | 66.8 | 120.2 | 10,000 | 9,900 | 9,700 | 8,800 | | | 85 |
| 90 | 57.9 | 121.3 | 16,800 | 14,800 | 12,900 | 11,400 | 64.2 | 116.5 | 9,600 | 9,500 | 9,400 | 8,800 | | | 90 |
| 95 | 55.4 | 117.4 | 16,100 | 14,700 | 12,800 | 11,400 | 61.6 | 112.4 | 9,300 | 9,200 | 9,100 | 8,800 | | | 95 |
| 100 | 52.7 | 113.1 | 15,000 | 14,400 | 12,700 | 11,200 | 58.8 | 107.9 | 9,000 | 8,900 | 8,800 | 8,700 | | | 100 |
| 105 | 50.0 | 108.3 | 14,000 | 13,500 | 12,500 | 11,100 | 55.9 | 102.9 | 8,700 | 8,700 | 8,600 | 8,500 | | | 105 |
| 110 | 47.1 | 103.1 | 13,100 | 12,600 | 12,200 | 11,100 | 52.8 | 97.4 | 8,500 | 8,400 | 8,400 | 8,300 | | | 110 |
| 115 | 44.0 | 97.4 | 12,200 | 11,800 | 11,400 | 11,000 | 49.6 | 91.3 | 8,300 | 8,200 | 8,200 | 8,100 | | | 115 |
| 120 | 40.7 | 90.9 | 11,500 | 11,100 | 10,800 | 10,400 | 46.0 | 84.3 | 8,100 | 8,000 | 8,000 | 7,900 | | | 120 |
| 125 | 37.2 | 83.5 | 10,800 | 10,500 | 10,100 | 9,800 | 42.1 | 76.2 | 7,900 | 7,900 | 7,800 | 7,800 | | | 125 |
| 130 | 33.2 | 75.0 | 10,100 | 9,800 | 9,600 | 9,300 | 37.7 | 66.7 | 7,800 | 7,700 | 7,700 | 7,700 | | | 130 |
| 135 | 28.7 | 64.9 | 9,500 | 9,300 | 9,000 | 8,800 | 32.3 | 54.8 | 7,700 | 7,700 | 7,700 | 7,600 | | | 135 |
| 140 | 23.1 | 52.0 | 9,000 | 8,700 | 8,500 | 8,300 | | | | | | | | | 140 |

MLC90A-1 S-2

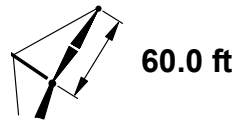
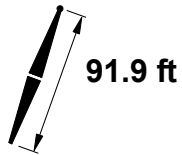
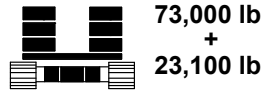
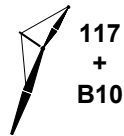

| | 10° | | | | | | | 30° | | | | | | | |
|-----|------|-------|--------|----------|----------|----------|----------|-------|--------|----------|----------|----------|----------|-----|--|
| | | | | | | | | | | | | | | | |
| | ft | ° | ft | 0° lb | 1° lb | 2° lb | 3° lb | ° | ft | 0° lb | 1° lb | 2° lb | 3° lb | ft | |
| 40 | 81.0 | 155.3 | 20,300 | | | | | | | | | | | 40 | |
| 42 | 80.2 | 154.8 | 20,200 | | | | | | | | | | | 42 | |
| 44 | 79.4 | 154.3 | 20,100 | 17,000 | | | | | | | | | | 44 | |
| 46 | 78.6 | 153.7 | 19,900 | 16,900 | 14,400 | | | | | | | | | 46 | |
| 48 | 77.9 | 153.1 | 19,800 | 16,800 | 14,300 | 12,500 | | | | | | | | 48 | |
| 50 | 77.1 | 152.5 | 19,700 | 16,700 | 14,300 | 12,400 | | | | | | | | 50 | |
| 55 | 75.1 | 150.9 | 19,300 | 16,500 | 14,100 | 12,300 | | | | | | | | 55 | |
| 60 | 73.1 | 149.0 | 19,000 | 16,200 | 13,900 | 12,200 | 79.5 | 144.8 | 12,500 | 12,300 | | | | 60 | |
| 65 | 71.1 | 147.0 | 18,700 | 16,000 | 13,800 | 12,000 | 77.4 | 142.7 | 12,000 | 11,800 | 10,400 | 8,600 | | 65 | |
| 70 | 69.0 | 144.7 | 18,400 | 15,800 | 13,600 | 11,900 | 75.3 | 140.3 | 11,500 | 11,300 | 10,400 | 8,600 | | 70 | |
| 75 | 66.9 | 142.2 | 18,100 | 15,600 | 13,500 | 11,900 | 73.1 | 137.7 | 11,100 | 10,900 | 10,300 | 8,600 | | 75 | |
| 80 | 64.8 | 139.5 | 17,800 | 15,400 | 13,300 | 11,700 | 70.9 | 134.9 | 10,600 | 10,500 | 10,300 | 8,600 | | 80 | |
| 85 | 62.6 | 136.5 | 17,400 | 15,200 | 13,200 | 11,600 | 68.6 | 131.8 | 10,300 | 10,100 | 10,000 | 8,600 | | 85 | |
| 90 | 60.3 | 133.3 | 17,100 | 15,000 | 13,000 | 11,500 | 66.3 | 128.5 | 9,900 | 9,800 | 9,600 | 8,600 | | 90 | |
| 95 | 58.0 | 129.8 | 15,900 | 14,800 | 12,900 | 11,400 | 63.9 | 124.8 | 9,600 | 9,500 | 9,300 | 8,600 | | 95 | |
| 100 | 55.7 | 125.9 | 14,800 | 14,200 | 12,800 | 11,300 | 61.4 | 120.8 | 9,300 | 9,200 | 9,100 | 8,600 | | 100 | |
| 105 | 53.2 | 121.7 | 13,800 | 13,200 | 12,600 | 11,200 | 58.9 | 116.4 | 9,000 | 8,900 | 8,800 | 8,600 | | 105 | |
| 110 | 50.7 | 117.2 | 12,900 | 12,400 | 11,900 | 11,100 | 56.2 | 111.6 | 8,800 | 8,700 | 8,600 | 8,500 | | 110 | |
| 115 | 48.0 | 112.2 | 12,000 | 11,600 | 11,200 | 10,800 | 53.4 | 106.3 | 8,500 | 8,500 | 8,400 | 8,300 | | 115 | |
| 120 | 45.2 | 106.7 | 11,300 | 10,900 | 10,500 | 10,200 | 50.4 | 100.5 | 8,300 | 8,300 | 8,200 | 8,200 | | 120 | |
| 125 | 42.3 | 100.6 | 10,600 | 10,200 | 9,900 | 9,600 | 47.2 | 94.0 | 8,100 | 8,100 | 8,000 | 8,000 | | 125 | |
| 130 | 39.1 | 93.7 | 10,000 | 9,600 | 9,300 | 9,000 | 43.8 | 86.6 | 8,000 | 7,900 | 7,900 | 7,900 | | 130 | |
| 135 | 35.6 | 86.0 | 9,400 | 9,100 | 8,800 | 8,500 | 40.0 | 78.1 | 7,800 | 7,800 | 7,800 | 7,700 | | 135 | |
| 140 | 31.8 | 77.1 | 8,800 | 8,600 | 8,300 | 8,100 | 35.7 | 68.1 | 7,700 | 7,700 | 7,700 | 7,700 | | 140 | |
| 145 | 27.4 | 66.5 | 8,300 | 8,100 | 7,900 | 7,600 | 30.4 | 55.5 | 7,700 | 7,600 | 7,600 | 7,600 | | 145 | |
| 150 | 22.0 | 53.0 | 7,700 | 7,600 | 7,400 | 7,200 | | | | | | | | 150 | |

MLC90A-1 S-2

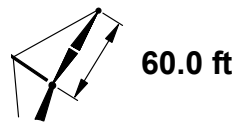
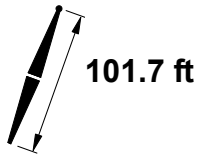
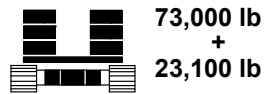

| | 10° | | | | | | | 30° | | | | | | |
|-----|------|-------|--------|----------|----------|----------|----------|-------|--------|----------|----------|----------|----------|-----|
| | | | | | | | | | | | | | | |
| | ft | ° | ft | 0° lb | 1° lb | 2° lb | 3° lb | ° | ft | 0° lb | 1° lb | 2° lb | 3° lb | ft |
| 42 | 80.8 | 164.9 | 20,200 | | | | | | | | | | | 42 |
| 44 | 80.1 | 164.4 | 20,100 | | | | | | | | | | | 44 |
| 46 | 79.4 | 163.9 | 20,000 | 16,900 | | | | | | | | | | 46 |
| 48 | 78.6 | 163.3 | 19,800 | 16,800 | 14,300 | | | | | | | | | 48 |
| 50 | 77.9 | 162.8 | 19,700 | 16,700 | 14,200 | 12,400 | | | | | | | | 50 |
| 55 | 76.0 | 161.2 | 19,400 | 16,500 | 14,000 | 12,300 | | | | | | | | 55 |
| 60 | 74.2 | 159.5 | 19,100 | 16,300 | 13,900 | 12,100 | 80.2 | 155.1 | 12,700 | | | | | 60 |
| 65 | 72.3 | 157.6 | 18,800 | 16,100 | 13,800 | 12,100 | 78.2 | 153.2 | 12,200 | 12,000 | 10,100 | | | 65 |
| 70 | 70.4 | 155.5 | 18,500 | 15,900 | 13,700 | 11,900 | 76.3 | 151.0 | 11,700 | 11,500 | 10,100 | 8,400 | | 70 |
| 75 | 68.4 | 153.2 | 18,300 | 15,700 | 13,500 | 11,800 | 74.3 | 148.6 | 11,300 | 11,100 | 10,100 | 8,300 | | 75 |
| 80 | 66.5 | 150.7 | 18,000 | 15,500 | 13,400 | 11,700 | 72.2 | 146.0 | 10,900 | 10,700 | 10,100 | 8,300 | | 80 |
| 85 | 64.4 | 148.0 | 17,600 | 15,300 | 13,300 | 11,700 | 70.1 | 143.2 | 10,500 | 10,300 | 10,100 | 8,300 | | 85 |
| 90 | 62.4 | 145.0 | 16,900 | 15,200 | 13,100 | 11,600 | 68.0 | 140.1 | 10,200 | 10,000 | 9,900 | 8,300 | | 90 |
| 95 | 60.3 | 141.8 | 15,700 | 14,900 | 13,000 | 11,500 | 65.8 | 136.8 | 9,800 | 9,700 | 9,600 | 8,300 | | 95 |
| 100 | 58.1 | 138.3 | 14,500 | 13,900 | 12,900 | 11,400 | 63.6 | 133.2 | 9,600 | 9,400 | 9,300 | 8,300 | | 100 |
| 105 | 55.9 | 134.5 | 13,500 | 12,900 | 12,400 | 11,300 | 61.3 | 129.2 | 9,300 | 9,200 | 9,100 | 8,300 | | 105 |
| 110 | 53.6 | 130.4 | 12,600 | 12,100 | 11,600 | 11,100 | 58.9 | 124.9 | 9,000 | 8,900 | 8,800 | 8,300 | | 110 |
| 115 | 51.3 | 125.9 | 11,800 | 11,300 | 10,900 | 10,400 | 56.4 | 120.3 | 8,800 | 8,700 | 8,600 | 8,300 | | 115 |
| 120 | 48.8 | 121.1 | 11,000 | 10,600 | 10,200 | 9,800 | 53.8 | 115.2 | 8,600 | 8,500 | 8,400 | 8,300 | | 120 |
| 125 | 46.3 | 115.8 | 10,300 | 10,000 | 9,600 | 9,200 | 51.1 | 109.6 | 8,400 | 8,300 | 8,200 | 8,200 | | 125 |
| 130 | 43.6 | 110.0 | 9,700 | 9,400 | 9,000 | 8,700 | 48.2 | 103.4 | 8,200 | 8,100 | 8,100 | 8,000 | | 130 |
| 135 | 40.7 | 103.6 | 9,100 | 8,800 | 8,500 | 8,200 | 45.2 | 96.5 | 8,000 | 8,000 | 7,900 | 7,900 | | 135 |
| 140 | 37.6 | 96.5 | 8,600 | 8,300 | 8,000 | 7,700 | 41.8 | 88.8 | 7,900 | 7,900 | 7,800 | 7,800 | | 140 |
| 145 | 34.3 | 88.4 | 8,000 | 7,800 | 7,500 | 7,300 | 38.1 | 79.9 | 7,800 | 7,800 | 7,700 | 7,500 | | 145 |
| 150 | 30.5 | 79.1 | 7,600 | 7,300 | 7,100 | 6,900 | 33.9 | 69.3 | 7,700 | 7,500 | 7,200 | 7,000 | | 150 |
| 155 | 26.2 | 68.0 | 7,100 | 6,900 | 6,700 | 6,500 | | | | | | | | 155 |
| 160 | 20.9 | 53.9 | 6,300 | 6,300 | 6,200 | 6,100 | | | | | | | | 160 |

MLC90A-1 S-2

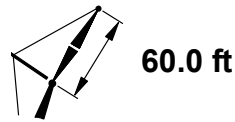
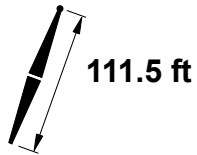
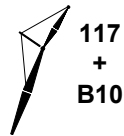

| | 10° | | | | | | | 30° | | | | | | | |
|-----|------|-------|--------|----------|----------|----------|----------|-------|--------|--------|----------|----------|----------|----------|-----|
| | | | | | | | | | | | | | | | |
| | ft | ° | ft | 0° lb | 1° lb | 2° lb | 3° lb | ft | ° | ft | 0° lb | 1° lb | 2° lb | 3° lb | |
| 44 | 80.7 | 174.5 | 20,000 | | | | | | | | | | | | 44 |
| 46 | 80.0 | 174.0 | 20,000 | 16,800 | | | | | | | | | | | 46 |
| 48 | 79.3 | 173.5 | 19,800 | 16,700 | | | | | | | | | | | 48 |
| 50 | 78.6 | 173.0 | 19,700 | 16,700 | 14,200 | | | | | | | | | | 50 |
| 55 | 76.9 | 171.5 | 19,500 | 16,500 | 14,100 | 12,200 | | | | | | | | | 55 |
| 60 | 75.1 | 169.9 | 19,100 | 16,300 | 13,900 | 12,100 | 80.8 | 165.4 | 12,900 | | | | | | 60 |
| 65 | 73.4 | 168.1 | 18,900 | 16,100 | 13,800 | 12,000 | 79.0 | 163.6 | 12,400 | 12,100 | 9,900 | | | | 65 |
| 70 | 71.6 | 166.2 | 18,600 | 15,900 | 13,600 | 12,000 | 77.1 | 161.6 | 11,900 | 11,700 | 9,800 | 8,100 | | | 70 |
| 75 | 69.8 | 164.0 | 18,400 | 15,800 | 13,500 | 11,900 | 75.3 | 159.4 | 11,500 | 11,300 | 9,800 | 8,100 | | | 75 |
| 80 | 67.9 | 161.7 | 18,200 | 15,600 | 13,500 | 11,800 | 73.4 | 156.9 | 11,100 | 10,900 | 9,800 | 8,100 | | | 80 |
| 85 | 66.1 | 159.2 | 17,800 | 15,400 | 13,300 | 11,700 | 71.4 | 154.3 | 10,700 | 10,600 | 9,800 | 8,100 | | | 85 |
| 90 | 64.2 | 156.4 | 16,700 | 15,300 | 13,200 | 11,600 | 69.5 | 151.5 | 10,400 | 10,200 | 9,800 | 8,100 | | | 90 |
| 95 | 62.2 | 153.4 | 15,400 | 14,600 | 13,000 | 11,500 | 67.5 | 148.4 | 10,100 | 9,900 | 9,800 | 8,100 | | | 95 |
| 100 | 60.2 | 150.2 | 14,300 | 13,600 | 13,000 | 11,500 | 65.4 | 145.1 | 9,800 | 9,700 | 9,500 | 8,100 | | | 100 |
| 105 | 58.2 | 146.8 | 13,300 | 12,700 | 12,100 | 11,400 | 63.3 | 141.5 | 9,500 | 9,400 | 9,300 | 8,100 | | | 105 |
| 110 | 56.1 | 143.0 | 12,400 | 11,800 | 11,300 | 10,800 | 61.2 | 137.6 | 9,300 | 9,200 | 9,000 | 8,100 | | | 110 |
| 115 | 54.0 | 139.0 | 11,600 | 11,100 | 10,600 | 10,100 | 58.9 | 133.4 | 9,000 | 8,900 | 8,800 | 8,100 | | | 115 |
| 120 | 51.8 | 134.7 | 10,800 | 10,300 | 9,900 | 9,500 | 56.6 | 128.9 | 8,800 | 8,700 | 8,600 | 8,100 | | | 120 |
| 125 | 49.5 | 130.0 | 10,100 | 9,700 | 9,300 | 8,900 | 54.2 | 124.0 | 8,600 | 8,500 | 8,500 | 8,100 | | | 125 |
| 130 | 47.1 | 124.9 | 9,500 | 9,100 | 8,700 | 8,400 | 51.7 | 118.6 | 8,400 | 8,300 | 8,300 | 8,100 | | | 130 |
| 135 | 44.7 | 119.3 | 8,900 | 8,500 | 8,200 | 7,900 | 49.1 | 112.7 | 8,200 | 8,200 | 8,100 | 8,100 | | | 135 |
| 140 | 42.0 | 113.2 | 8,300 | 8,000 | 7,700 | 7,400 | 46.3 | 106.2 | 8,100 | 8,000 | 8,000 | 7,700 | | | 140 |
| 145 | 39.2 | 106.5 | 7,800 | 7,500 | 7,300 | 7,000 | 43.3 | 99.0 | 8,000 | 7,800 | 7,500 | 7,200 | | | 145 |
| 150 | 36.3 | 99.1 | 7,300 | 7,100 | 6,800 | 6,600 | 40.1 | 90.9 | 7,500 | 7,300 | 7,000 | 6,800 | | | 150 |
| 155 | 33.0 | 90.7 | 6,900 | 6,700 | 6,400 | 6,200 | 36.4 | 81.6 | 7,000 | 6,800 | 6,600 | 6,400 | | | 155 |
| 160 | 29.4 | 81.0 | 6,500 | 6,300 | 6,100 | 5,900 | 32.3 | 70.5 | 6,600 | 6,400 | 6,200 | 6,000 | | | 160 |
| 165 | 25.2 | 69.4 | 6,100 | 5,900 | 5,700 | 5,500 | | | | | | | | | 165 |

MLC90A-1 S-2



73,000 lb
+
23,100 lb

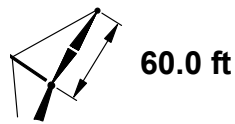
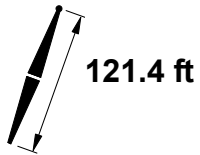

| | 10° | | | | | | | 30° | | | | | | |
|-----|------|-------|--------|--------|--------|--------|------|-------|--------|--------|-------|-------|----|-----|
| | | | | | | | | | | | | | | |
| | | | | | | | | | | | | | | |
| | | | | | | | | | | | | | | |
| | ft | ° | ft | lb | lb | lb | lb | ° | ft | lb | lb | lb | lb | ft |
| 46 | 80.5 | 184.1 | 19,900 | | | | | | | | | | | 46 |
| 48 | 79.9 | 183.6 | 19,800 | 16,700 | | | | | | | | | | 48 |
| 50 | 79.2 | 183.1 | 19,700 | 16,600 | | | | | | | | | | 50 |
| 55 | 77.6 | 181.8 | 19,500 | 16,500 | 14,000 | 12,200 | | | | | | | | 55 |
| 60 | 76.0 | 180.3 | 19,200 | 16,300 | 13,900 | 12,100 | | | | | | | | 60 |
| 65 | 74.3 | 178.6 | 18,900 | 16,100 | 13,700 | 12,000 | 79.6 | 173.9 | 12,600 | 12,100 | | | | 65 |
| 70 | 72.6 | 176.7 | 18,700 | 16,000 | 13,600 | 11,900 | 77.9 | 172.0 | 12,100 | 11,900 | 9,700 | 8,000 | | 70 |
| 75 | 70.9 | 174.7 | 18,500 | 15,800 | 13,600 | 11,900 | 76.1 | 170.0 | 11,700 | 11,500 | 9,600 | 8,000 | | 75 |
| 80 | 69.2 | 172.5 | 18,300 | 15,600 | 13,500 | 11,800 | 74.4 | 167.7 | 11,300 | 11,100 | 9,600 | 8,000 | | 80 |
| 85 | 67.5 | 170.2 | 17,800 | 15,400 | 13,400 | 11,700 | 72.6 | 165.3 | 10,900 | 10,800 | 9,600 | 8,000 | | 85 |
| 90 | 65.7 | 167.6 | 16,400 | 15,300 | 13,200 | 11,600 | 70.8 | 162.6 | 10,600 | 10,400 | 9,600 | 8,000 | | 90 |
| 95 | 63.9 | 164.9 | 15,200 | 14,300 | 13,100 | 11,500 | 68.9 | 159.8 | 10,300 | 10,100 | 9,500 | 8,000 | | 95 |
| 100 | 62.1 | 161.9 | 14,000 | 13,300 | 12,600 | 11,500 | 67.0 | 156.7 | 10,000 | 9,900 | 9,500 | 8,000 | | 100 |
| 105 | 60.2 | 158.7 | 13,000 | 12,400 | 11,800 | 11,200 | 65.1 | 153.4 | 9,700 | 9,600 | 9,500 | 8,000 | | 105 |
| 110 | 58.3 | 155.3 | 12,100 | 11,500 | 11,000 | 10,400 | 63.1 | 149.9 | 9,500 | 9,400 | 9,200 | 8,000 | | 110 |
| 115 | 56.3 | 151.6 | 11,300 | 10,800 | 10,200 | 9,700 | 61.1 | 146.0 | 9,200 | 9,100 | 9,000 | 8,000 | | 115 |
| 120 | 54.3 | 147.6 | 10,500 | 10,100 | 9,600 | 9,100 | 59.0 | 141.9 | 9,000 | 8,900 | 8,800 | 8,000 | | 120 |
| 125 | 52.3 | 143.4 | 9,800 | 9,400 | 9,000 | 8,600 | 56.8 | 137.5 | 8,800 | 8,700 | 8,600 | 8,000 | | 125 |
| 130 | 50.1 | 138.8 | 9,200 | 8,800 | 8,400 | 8,000 | 54.6 | 132.7 | 8,600 | 8,500 | 8,500 | 8,000 | | 130 |
| 135 | 47.9 | 133.9 | 8,600 | 8,200 | 7,900 | 7,500 | 52.3 | 127.5 | 8,500 | 8,400 | 8,200 | 7,900 | | 135 |
| 140 | 45.6 | 128.5 | 8,100 | 7,700 | 7,400 | 7,100 | 49.8 | 121.9 | 8,300 | 8,100 | 7,700 | 7,400 | | 140 |
| 145 | 43.2 | 122.7 | 7,600 | 7,300 | 7,000 | 6,700 | 47.3 | 115.7 | 7,800 | 7,500 | 7,200 | 6,900 | | 145 |
| 150 | 40.6 | 116.4 | 7,100 | 6,800 | 6,500 | 6,300 | 44.5 | 108.9 | 7,300 | 7,100 | 6,800 | 6,500 | | 150 |
| 155 | 37.9 | 109.4 | 6,600 | 6,400 | 6,100 | 5,900 | 41.6 | 101.4 | 6,900 | 6,600 | 6,300 | 6,100 | | 155 |
| 160 | 35.0 | 101.6 | 6,200 | 6,000 | 5,800 | 5,500 | 38.5 | 92.9 | 6,400 | 6,200 | 5,900 | 5,700 | | 160 |
| 165 | 31.9 | 92.9 | 5,800 | 5,600 | 5,400 | 5,200 | 34.9 | 83.2 | 6,000 | 5,700 | 5,500 | 5,300 | | 165 |
| 170 | 28.3 | 82.8 | 5,500 | 5,300 | 5,100 | 4,900 | 30.9 | 71.6 | 5,500 | 5,400 | 5,200 | 5,000 | | 170 |
| 175 | 24.2 | 70.8 | 5,100 | 4,900 | 4,800 | 4,600 | | | | | | | | 175 |

MLC90A-1 S-2

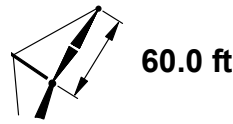
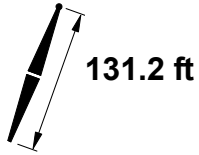
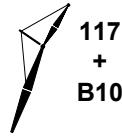

| | 10° | | | | | | | 30° | | | | | | | | |
|-----|------|-------|--------|----------|----------|----------|----------|-------|--------|--------|----------|----------|----------|----------|--|-----|
| | | | | | | | | | | | | | | | | |
| | ft | ° | ft | 0° lb | 1° lb | 2° lb | 3° lb | ft | ° | ft | 0° lb | 1° lb | 2° lb | 3° lb | | ft |
| 48 | 80.4 | 193.7 | 19,700 | | | | | | | | | | | | | 48 |
| 50 | 79.8 | 193.3 | 19,600 | 16,500 | | | | | | | | | | | | 50 |
| 55 | 78.3 | 192.0 | 19,400 | 16,300 | 13,900 | | | | | | | | | | | 55 |
| 60 | 76.7 | 190.5 | 19,200 | 16,200 | 13,800 | 12,000 | | | | | | | | | | 60 |
| 65 | 75.1 | 189.0 | 18,900 | 16,100 | 13,700 | 12,000 | 80.2 | 184.2 | 12,700 | | | | | | | 65 |
| 70 | 73.6 | 187.2 | 18,800 | 16,000 | 13,600 | 11,900 | 78.6 | 182.5 | 12,300 | 11,800 | 9,400 | | | | | 70 |
| 75 | 72.0 | 185.3 | 18,500 | 15,800 | 13,500 | 11,800 | 76.9 | 180.5 | 11,900 | 11,600 | 9,400 | 7,800 | | | | 75 |
| 80 | 70.3 | 183.3 | 18,300 | 15,600 | 13,400 | 11,700 | 75.3 | 178.4 | 11,500 | 11,300 | 9,400 | 7,800 | | | | 80 |
| 85 | 68.7 | 181.1 | 17,600 | 15,500 | 13,300 | 11,700 | 73.6 | 176.1 | 11,100 | 10,900 | 9,300 | 7,800 | | | | 85 |
| 90 | 67.1 | 178.7 | 16,200 | 15,200 | 13,200 | 11,600 | 71.9 | 173.6 | 10,800 | 10,600 | 9,300 | 7,800 | | | | 90 |
| 95 | 65.4 | 176.1 | 15,000 | 14,100 | 13,100 | 11,500 | 70.1 | 171.0 | 10,500 | 10,300 | 9,300 | 7,800 | | | | 95 |
| 100 | 63.7 | 173.3 | 13,800 | 13,100 | 12,300 | 11,400 | 68.4 | 168.1 | 10,200 | 10,100 | 9,300 | 7,800 | | | | 100 |
| 105 | 61.9 | 170.3 | 12,800 | 12,100 | 11,500 | 10,900 | 66.6 | 165.1 | 9,900 | 9,800 | 9,300 | 7,800 | | | | 105 |
| 110 | 60.2 | 167.2 | 11,900 | 11,300 | 10,700 | 10,100 | 64.8 | 161.8 | 9,700 | 9,600 | 9,300 | 7,800 | | | | 110 |
| 115 | 58.4 | 163.8 | 11,100 | 10,500 | 10,000 | 9,500 | 62.9 | 158.3 | 9,500 | 9,300 | 9,200 | 7,800 | | | | 115 |
| 120 | 56.5 | 160.1 | 10,300 | 9,800 | 9,300 | 8,800 | 61.0 | 154.5 | 9,200 | 9,100 | 9,000 | 7,800 | | | | 120 |
| 125 | 54.6 | 156.2 | 9,600 | 9,200 | 8,700 | 8,300 | 59.0 | 150.4 | 9,000 | 8,900 | 8,800 | 7,800 | | | | 125 |
| 130 | 52.7 | 152.1 | 9,000 | 8,600 | 8,200 | 7,800 | 57.0 | 146.1 | 8,800 | 8,700 | 8,600 | 7,800 | | | | 130 |
| 135 | 50.7 | 147.6 | 8,400 | 8,000 | 7,600 | 7,300 | 54.9 | 141.4 | 8,700 | 8,400 | 8,000 | 7,700 | | | | 135 |
| 140 | 48.6 | 142.8 | 7,900 | 7,500 | 7,200 | 6,800 | 52.7 | 136.4 | 8,200 | 7,900 | 7,500 | 7,200 | | | | 140 |
| 145 | 46.4 | 137.6 | 7,400 | 7,000 | 6,700 | 6,400 | 50.5 | 130.9 | 7,700 | 7,400 | 7,000 | 6,700 | | | | 145 |
| 150 | 44.2 | 132.0 | 6,900 | 6,600 | 6,300 | 6,000 | 48.1 | 125.0 | 7,200 | 6,900 | 6,600 | 6,300 | | | | 150 |
| 155 | 41.8 | 125.9 | 6,500 | 6,200 | 5,900 | 5,600 | 45.6 | 118.6 | 6,700 | 6,400 | 6,100 | 5,900 | | | | 155 |
| 160 | 39.4 | 119.3 | 6,000 | 5,800 | 5,500 | 5,300 | 42.9 | 111.5 | 6,300 | 6,000 | 5,700 | 5,500 | | | | 160 |
| 165 | 36.7 | 112.1 | 5,600 | 5,400 | 5,200 | 5,000 | 40.1 | 103.7 | 5,800 | 5,600 | 5,400 | 5,100 | | | | 165 |
| 170 | 33.9 | 104.0 | 5,300 | 5,100 | 4,900 | 4,600 | 37.0 | 94.9 | 5,400 | 5,200 | 5,000 | 4,800 | | | | 170 |
| 175 | 30.8 | 95.0 | 4,900 | 4,700 | 4,500 | 4,300 | 33.5 | 84.7 | 5,000 | 4,800 | 4,700 | 4,500 | | | | 175 |
| 180 | 27.4 | 84.5 | 4,600 | 4,400 | 4,200 | 4,100 | 29.5 | 72.7 | 4,700 | 4,500 | 4,300 | 4,100 | | | | 180 |
| 185 | 23.3 | 72.1 | 4,200 | 4,100 | 4,000 | 3,800 | | | | | | | | | | 185 |

MLC90A-1 S-2



73,000 lb
+
23,100 lb

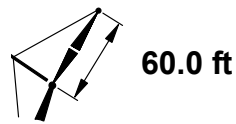
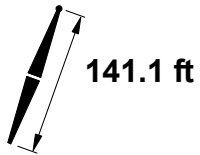

| | 10° | | | | | | | 30° | | | | | | |
|-----|------|-------|--------|--------|--------|--------|------|-------|--------|--------|-------|-------|-----|--|
| | | | | | | | | | | | | | | |
| | ft | ° | 0° | 1° | 2° | 3° | ° | ft | 0° | 1° | 2° | 3° | ft | |
| 48 | 80.9 | 203.8 | 19,600 | | | | | | | | | | 48 | |
| 50 | 80.3 | 203.4 | 19,500 | | | | | | | | | | 50 | |
| 55 | 78.9 | 202.1 | 19,300 | 16,200 | 13,800 | | | | | | | | 55 | |
| 60 | 77.4 | 200.8 | 19,100 | 16,100 | 13,700 | 11,700 | | | | | | | 60 | |
| 65 | 75.9 | 199.3 | 18,900 | 16,000 | 13,600 | 11,600 | 80.7 | 194.5 | 12,900 | | | | 65 | |
| 70 | 74.4 | 197.6 | 18,700 | 15,900 | 13,500 | 11,600 | 79.2 | 192.8 | 12,400 | 11,500 | | | 70 | |
| 75 | 72.9 | 195.9 | 18,500 | 15,800 | 13,500 | 11,600 | 77.6 | 191.0 | 12,000 | 11,400 | 9,300 | 7,700 | 75 | |
| 80 | 71.4 | 193.9 | 18,400 | 15,600 | 13,300 | 11,600 | 76.1 | 189.0 | 11,700 | 11,300 | 9,200 | 7,700 | 80 | |
| 85 | 69.8 | 191.8 | 17,400 | 15,500 | 13,300 | 11,600 | 74.5 | 186.8 | 11,300 | 11,100 | 9,200 | 7,700 | 85 | |
| 90 | 68.3 | 189.6 | 16,000 | 14,900 | 13,200 | 11,600 | 72.9 | 184.5 | 11,000 | 10,800 | 9,200 | 7,700 | 90 | |
| 95 | 66.7 | 187.1 | 14,700 | 13,800 | 13,000 | 11,500 | 71.2 | 182.0 | 10,700 | 10,500 | 9,100 | 7,700 | 95 | |
| 100 | 65.1 | 184.6 | 13,600 | 12,800 | 12,000 | 11,300 | 69.6 | 179.3 | 10,400 | 10,200 | 9,100 | 7,700 | 100 | |
| 105 | 63.5 | 181.8 | 12,600 | 11,800 | 11,200 | 10,500 | 67.9 | 176.5 | 10,100 | 10,000 | 9,100 | 7,700 | 105 | |
| 110 | 61.8 | 178.8 | 11,700 | 11,000 | 10,400 | 9,800 | 66.2 | 173.4 | 9,900 | 9,800 | 9,100 | 7,700 | 110 | |
| 115 | 60.1 | 175.6 | 10,800 | 10,200 | 9,700 | 9,100 | 64.5 | 170.1 | 9,700 | 9,500 | 9,100 | 7,700 | 115 | |
| 120 | 58.4 | 172.3 | 10,100 | 9,500 | 9,000 | 8,500 | 62.7 | 166.6 | 9,400 | 9,300 | 9,100 | 7,700 | 120 | |
| 125 | 56.7 | 168.7 | 9,400 | 8,900 | 8,400 | 8,000 | 60.9 | 162.9 | 9,200 | 9,100 | 8,900 | 7,700 | 125 | |
| 130 | 54.9 | 164.8 | 8,800 | 8,300 | 7,900 | 7,400 | 59.0 | 158.9 | 9,000 | 8,800 | 8,300 | 7,700 | 130 | |
| 135 | 53.0 | 160.7 | 8,200 | 7,700 | 7,300 | 6,900 | 57.1 | 154.7 | 8,600 | 8,200 | 7,800 | 7,400 | 135 | |
| 140 | 51.1 | 156.3 | 7,600 | 7,200 | 6,900 | 6,500 | 55.1 | 150.1 | 8,000 | 7,600 | 7,300 | 6,900 | 140 | |
| 145 | 49.2 | 151.6 | 7,100 | 6,800 | 6,400 | 6,100 | 53.1 | 145.2 | 7,500 | 7,100 | 6,800 | 6,400 | 145 | |
| 150 | 47.2 | 146.6 | 6,600 | 6,300 | 6,000 | 5,700 | 51.0 | 139.9 | 7,000 | 6,600 | 6,300 | 6,000 | 150 | |
| 155 | 45.1 | 141.2 | 6,200 | 5,900 | 5,600 | 5,300 | 48.8 | 134.2 | 6,500 | 6,200 | 5,900 | 5,600 | 155 | |
| 160 | 42.9 | 135.4 | 5,800 | 5,500 | 5,200 | 5,000 | 46.5 | 128.1 | 6,100 | 5,800 | 5,500 | 5,200 | 160 | |
| 165 | 40.6 | 129.1 | 5,400 | 5,100 | 4,900 | 4,600 | 44.1 | 121.4 | 5,600 | 5,400 | 5,100 | 4,900 | 165 | |
| 170 | 38.2 | 122.2 | 5,000 | 4,800 | 4,600 | 4,300 | 41.5 | 114.0 | 5,200 | 5,000 | 4,800 | 4,500 | 170 | |
| 175 | 35.6 | 114.7 | 4,700 | 4,500 | 4,200 | 4,000 | 38.7 | 105.9 | 4,900 | 4,600 | 4,400 | 4,200 | 175 | |
| 180 | 32.9 | 106.4 | 4,300 | 4,100 | 4,000 | 3,800 | 35.7 | 96.7 | 4,500 | 4,300 | 4,100 | 3,900 | 180 | |
| 185 | 29.8 | 97.0 | 4,000 | 3,900 | 3,700 | 3,500 | 32.3 | 86.2 | 4,100 | 4,000 | 3,800 | 3,600 | 185 | |
| 190 | 26.5 | 86.2 | 3,600 | 3,500 | 3,400 | 3,200 | | | | | | | 190 | |
| 195 | 22.5 | 73.2 | 3,100 | 3,000 | 2,900 | 2,900 | | | | | | | 195 | |

MLC90A-1 S-2

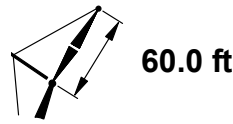
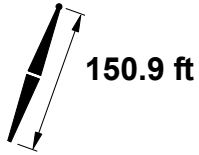
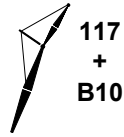

| | 10° | | | | | | | 30° | | | | | | |
|-----|------|-------|--------|--------|--------|--------|------|-------|--------|--------|-------|-------|----|-----|
| | | | | | | | | | | | | | | |
| | | | | | | | | | | | | | | |
| ft | ° | ft | lb | lb | lb | lb | ° | ft | lb | lb | lb | lb | ft | |
| 50 | 80.8 | 213.4 | 19,400 | | | | | | | | | | | 50 |
| 55 | 79.4 | 212.3 | 19,200 | 16,200 | | | | | | | | | | 55 |
| 60 | 78.0 | 211.0 | 19,000 | 16,000 | 13,500 | 10,700 | | | | | | | | 60 |
| 65 | 76.6 | 209.6 | 18,800 | 15,900 | 13,500 | 10,700 | | | | | | | | 65 |
| 70 | 75.2 | 208.0 | 18,700 | 15,800 | 13,400 | 10,700 | 79.7 | 203.1 | 12,600 | 11,200 | | | | 70 |
| 75 | 73.7 | 206.3 | 18,400 | 15,700 | 13,400 | 10,700 | 78.2 | 201.4 | 12,200 | 11,200 | 9,100 | | | 75 |
| 80 | 72.3 | 204.5 | 18,300 | 15,500 | 13,300 | 10,700 | 76.8 | 199.5 | 11,800 | 11,100 | 9,100 | 7,500 | | 80 |
| 85 | 70.8 | 202.5 | 17,100 | 15,400 | 13,200 | 10,700 | 75.3 | 197.4 | 11,500 | 11,100 | 9,000 | 7,500 | | 85 |
| 90 | 69.4 | 200.4 | 15,700 | 14,700 | 13,100 | 10,700 | 73.8 | 195.3 | 11,200 | 11,000 | 9,000 | 7,500 | | 90 |
| 95 | 67.9 | 198.1 | 14,500 | 13,500 | 12,600 | 10,700 | 72.2 | 192.9 | 10,900 | 10,700 | 9,000 | 7,500 | | 95 |
| 100 | 66.4 | 195.6 | 13,400 | 12,500 | 11,700 | 10,700 | 70.7 | 190.4 | 10,600 | 10,400 | 9,000 | 7,500 | | 100 |
| 105 | 64.8 | 193.0 | 12,300 | 11,600 | 10,900 | 10,200 | 69.1 | 187.7 | 10,300 | 10,200 | 9,000 | 7,500 | | 105 |
| 110 | 63.3 | 190.2 | 11,400 | 10,700 | 10,100 | 9,500 | 67.5 | 184.8 | 10,100 | 9,900 | 8,900 | 7,500 | | 110 |
| 115 | 61.7 | 187.3 | 10,600 | 10,000 | 9,400 | 8,800 | 65.9 | 181.8 | 9,800 | 9,700 | 8,900 | 7,500 | | 115 |
| 120 | 60.1 | 184.1 | 9,800 | 9,300 | 8,700 | 8,200 | 64.2 | 178.5 | 9,600 | 9,500 | 8,900 | 7,500 | | 120 |
| 125 | 58.5 | 180.8 | 9,200 | 8,600 | 8,100 | 7,600 | 62.5 | 175.0 | 9,400 | 9,200 | 8,700 | 7,500 | | 125 |
| 130 | 56.8 | 177.2 | 8,500 | 8,000 | 7,600 | 7,100 | 60.8 | 171.3 | 9,000 | 8,600 | 8,100 | 7,500 | | 130 |
| 135 | 55.1 | 173.4 | 7,900 | 7,500 | 7,100 | 6,600 | 59.1 | 167.4 | 8,400 | 8,000 | 7,500 | 7,100 | | 135 |
| 140 | 53.4 | 169.3 | 7,400 | 7,000 | 6,600 | 6,200 | 57.2 | 163.2 | 7,800 | 7,400 | 7,000 | 6,600 | | 140 |
| 145 | 51.6 | 165.0 | 6,900 | 6,500 | 6,100 | 5,800 | 55.4 | 158.7 | 7,300 | 6,900 | 6,500 | 6,200 | | 145 |
| 150 | 49.7 | 160.5 | 6,400 | 6,100 | 5,700 | 5,400 | 53.5 | 154.0 | 6,800 | 6,400 | 6,100 | 5,700 | | 150 |
| 155 | 47.8 | 155.6 | 6,000 | 5,600 | 5,300 | 5,000 | 51.5 | 148.8 | 6,300 | 6,000 | 5,700 | 5,300 | | 155 |
| 160 | 45.9 | 150.3 | 5,600 | 5,200 | 5,000 | 4,700 | 49.4 | 143.3 | 5,900 | 5,600 | 5,300 | 5,000 | | 160 |
| 165 | 43.8 | 144.7 | 5,200 | 4,900 | 4,600 | 4,300 | 47.3 | 137.4 | 5,400 | 5,200 | 4,900 | 4,600 | | 165 |
| 170 | 41.7 | 138.7 | 4,800 | 4,500 | 4,300 | 4,000 | 45.0 | 131.0 | 5,000 | 4,800 | 4,500 | 4,300 | | 170 |
| 175 | 39.5 | 132.1 | 4,500 | 4,200 | 4,000 | 3,800 | 42.7 | 124.1 | 4,700 | 4,400 | 4,200 | 4,000 | | 175 |
| 180 | 37.1 | 125.0 | 4,100 | 3,900 | 3,700 | 3,500 | 40.1 | 116.4 | 4,300 | 4,100 | 3,900 | 3,700 | | 180 |
| 185 | 34.6 | 117.2 | 3,800 | 3,600 | 3,400 | 3,200 | 37.4 | 108.0 | 4,000 | 3,800 | 3,600 | 3,400 | | 185 |
| 190 | 31.9 | 108.6 | 3,500 | 3,300 | 3,100 | 3,000 | 34.4 | 98.5 | 3,600 | 3,500 | 3,300 | 3,100 | | 190 |
| 195 | 28.9 | 98.9 | 3,100 | 3,000 | 2,900 | 2,700 | 31.1 | 87.6 | 3,200 | 3,100 | 3,000 | 2,800 | | 195 |
| 200 | 25.6 | 87.7 | 2,700 | 2,600 | 2,500 | 2,400 | | | | | | | | 200 |
| 205 | 21.8 | 74.4 | 2,100 | 2,000 | 2,000 | | | | | | | | | 205 |

MLC90A-1 S-2



73,000 lb
+
23,100 lb

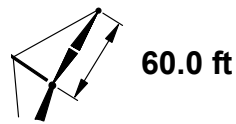
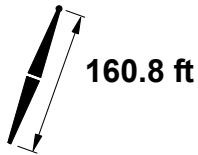

| | 10° | | | | | | | 30° | | | | | | |
|-----|------|-------|--------|----------|----------|----------|----------|-------|--------|----------|----------|----------|----------|-----|
| | | | | | | | | | | | | | | |
| | ft | ° | ft | 0° lb | 1° lb | 2° lb | 3° lb | ° | ft | 0° lb | 1° lb | 2° lb | 3° lb | ft |
| 55 | 79.9 | 222.4 | 19,000 | 16,000 | | | | | | | | | | 55 |
| 60 | 78.5 | 221.2 | 18,900 | 15,800 | | | | | | | | | | 60 |
| 65 | 77.2 | 219.8 | 18,600 | 15,700 | 12,700 | | | | | | | | | 65 |
| 70 | 75.8 | 218.3 | 18,400 | 15,700 | 12,700 | 9,700 | | 80.2 | 213.3 | 12,700 | | | | 70 |
| 75 | 74.5 | 216.7 | 18,200 | 15,600 | 12,700 | 9,700 | | 78.8 | 211.7 | 12,300 | 11,000 | 8,900 | | 75 |
| 80 | 73.1 | 215.0 | 17,900 | 15,500 | 12,700 | 9,700 | 77.4 | 209.9 | 12,000 | 10,900 | 8,900 | 7,400 | | 80 |
| 85 | 71.7 | 213.1 | 16,900 | 15,300 | 12,700 | 9,700 | 76.0 | 208.0 | 11,600 | 10,900 | 8,900 | 7,400 | | 85 |
| 90 | 70.3 | 211.1 | 15,500 | 14,400 | 12,700 | 9,700 | 74.6 | 205.9 | 11,300 | 10,800 | 8,900 | 7,400 | | 90 |
| 95 | 68.9 | 208.9 | 14,200 | 13,200 | 12,300 | 9,700 | 73.1 | 203.7 | 11,000 | 10,700 | 8,800 | 7,400 | | 95 |
| 100 | 67.5 | 206.6 | 13,100 | 12,200 | 11,400 | 9,700 | 71.6 | 201.3 | 10,800 | 10,600 | 8,800 | 7,400 | | 100 |
| 105 | 66.0 | 204.1 | 12,100 | 11,300 | 10,500 | 9,700 | 70.2 | 198.8 | 10,500 | 10,300 | 8,800 | 7,400 | | 105 |
| 110 | 64.6 | 201.5 | 11,200 | 10,400 | 9,800 | 9,100 | 68.7 | 196.1 | 10,300 | 10,100 | 8,800 | 7,400 | | 110 |
| 115 | 63.1 | 198.7 | 10,300 | 9,700 | 9,100 | 8,500 | 67.1 | 193.2 | 10,000 | 9,900 | 8,800 | 7,400 | | 115 |
| 120 | 61.6 | 195.7 | 9,600 | 9,000 | 8,400 | 7,900 | 65.6 | 190.1 | 9,800 | 9,600 | 8,800 | 7,400 | | 120 |
| 125 | 60.1 | 192.6 | 8,900 | 8,300 | 7,800 | 7,300 | 64.0 | 186.9 | 9,500 | 8,900 | 8,400 | 7,400 | | 125 |
| 130 | 58.5 | 189.2 | 8,300 | 7,700 | 7,300 | 6,800 | 62.4 | 183.5 | 8,800 | 8,300 | 7,800 | 7,300 | | 130 |
| 135 | 56.9 | 185.7 | 7,700 | 7,200 | 6,700 | 6,300 | 60.8 | 179.8 | 8,200 | 7,700 | 7,300 | 6,800 | | 135 |
| 140 | 55.3 | 181.9 | 7,100 | 6,700 | 6,300 | 5,900 | 59.1 | 175.9 | 7,600 | 7,200 | 6,700 | 6,300 | | 140 |
| 145 | 53.6 | 178.0 | 6,600 | 6,200 | 5,800 | 5,500 | 57.4 | 171.8 | 7,100 | 6,700 | 6,300 | 5,900 | | 145 |
| 150 | 52.0 | 173.7 | 6,100 | 5,800 | 5,400 | 5,100 | 55.6 | 167.4 | 6,600 | 6,200 | 5,800 | 5,500 | | 150 |
| 155 | 50.2 | 169.2 | 5,700 | 5,400 | 5,000 | 4,700 | 53.8 | 162.7 | 6,100 | 5,700 | 5,400 | 5,100 | | 155 |
| 160 | 48.4 | 164.5 | 5,300 | 5,000 | 4,700 | 4,400 | 51.9 | 157.7 | 5,600 | 5,300 | 5,000 | 4,700 | | 160 |
| 165 | 46.6 | 159.4 | 4,900 | 4,600 | 4,300 | 4,000 | 50.0 | 152.4 | 5,200 | 4,900 | 4,600 | 4,300 | | 165 |
| 170 | 44.7 | 153.9 | 4,500 | 4,300 | 4,000 | 3,700 | 48.0 | 146.7 | 4,800 | 4,500 | 4,300 | 4,000 | | 170 |
| 175 | 42.7 | 148.1 | 4,200 | 3,900 | 3,700 | 3,400 | 45.9 | 140.5 | 4,500 | 4,200 | 3,900 | 3,700 | | 175 |
| 180 | 40.6 | 141.8 | 3,900 | 3,600 | 3,400 | 3,200 | 43.7 | 133.9 | 4,100 | 3,900 | 3,600 | 3,400 | | 180 |
| 185 | 38.4 | 135.1 | 3,600 | 3,300 | 3,100 | 2,900 | 41.4 | 126.7 | 3,800 | 3,500 | 3,300 | 3,100 | | 185 |
| 190 | 36.1 | 127.7 | 3,300 | 3,100 | 2,900 | 2,700 | 38.9 | 118.8 | 3,400 | 3,200 | 3,000 | 2,800 | | 190 |
| 195 | 33.7 | 119.7 | 2,900 | 2,700 | 2,600 | 2,400 | 36.2 | 110.0 | 3,100 | 2,900 | 2,700 | 2,600 | | 195 |
| 200 | 31.0 | 110.8 | 2,400 | 2,300 | 2,300 | 2,200 | 33.3 | 100.2 | 2,700 | 2,500 | 2,400 | 2,300 | | 200 |
| 205 | 28.1 | 100.8 | 2,000 | 2,000 | | | 30.0 | 88.9 | 2,200 | 2,100 | 2,000 | 2,000 | | 205 |

MLC90A-1 S-2

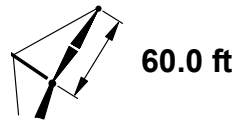
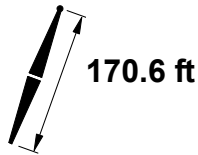
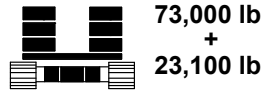
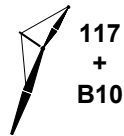

| ft | 10° | | | | | | | 30° | | | | | | | ft |
|-----|------|-------|---------------|--------|--------|-------|------|-------|---------------|--------|-------|-------|--|-----|----|
| | ° | ft | Counterweight | | | | ° | ft | Counterweight | | | | | | |
| | | | 0° | 1° | 2° | 3° | | | 0° | 1° | 2° | 3° | | | |
| lb | lb | lb | lb | lb | lb | lb | lb | lb | lb | lb | lb | lb | | | |
| 55 | 80.3 | 232.5 | 18,500 | 15,500 | 11,700 | 8,800 | | | | | | | | 55 | |
| 60 | 79.0 | 231.3 | 18,300 | 15,500 | 11,700 | 8,800 | 80.6 | 223.6 | 12,800 | | | | | 60 | |
| 65 | 77.8 | 230.0 | 18,100 | 15,500 | 11,700 | 8,800 | 79.3 | 222.0 | 12,500 | 10,800 | | | | 65 | |
| 70 | 76.5 | 228.6 | 17,800 | 15,500 | 11,600 | 8,800 | | | | | | | | 70 | |
| 75 | 75.2 | 227.0 | 17,600 | 15,400 | 11,600 | 8,800 | | | | | | | | 75 | |
| 80 | 73.9 | 225.4 | 17,400 | 15,300 | 11,600 | 8,800 | 78.0 | 220.3 | 12,100 | 10,600 | 8,700 | 6,800 | | 80 | |
| 85 | 72.5 | 223.6 | 16,700 | 15,200 | 11,600 | 8,800 | 76.6 | 218.4 | 11,800 | 10,600 | 8,700 | 6,800 | | 85 | |
| 90 | 71.2 | 221.7 | 15,300 | 14,100 | 11,600 | 8,700 | 75.3 | 216.5 | 11,500 | 10,500 | 8,600 | 6,800 | | 90 | |
| 95 | 69.9 | 219.6 | 14,000 | 13,000 | 11,600 | 8,700 | 73.9 | 214.4 | 11,200 | 10,500 | 8,600 | 6,800 | | 95 | |
| 100 | 68.5 | 217.4 | 12,900 | 11,900 | 11,100 | 8,700 | 72.5 | 212.1 | 10,900 | 10,400 | 8,600 | 6,800 | | 100 | |
| 105 | 67.2 | 215.1 | 11,900 | 11,000 | 10,200 | 8,700 | 71.1 | 209.7 | 10,700 | 10,400 | 8,600 | 6,800 | | 105 | |
| 110 | 65.8 | 212.6 | 11,000 | 10,200 | 9,500 | 8,700 | 69.7 | 207.2 | 10,400 | 10,300 | 8,600 | 6,800 | | 110 | |
| 115 | 64.4 | 210.0 | 10,100 | 9,400 | 8,800 | 8,200 | 68.2 | 204.5 | 10,200 | 10,000 | 8,600 | 6,800 | | 115 | |
| 120 | 62.9 | 207.2 | 9,400 | 8,700 | 8,100 | 7,600 | 66.8 | 201.6 | 10,000 | 9,400 | 8,600 | 6,800 | | 120 | |
| 125 | 61.5 | 204.2 | 8,700 | 8,100 | 7,500 | 7,000 | 65.3 | 198.5 | 9,300 | 8,700 | 8,200 | 6,800 | | 125 | |
| 130 | 60.0 | 201.1 | 8,000 | 7,500 | 7,000 | 6,500 | 63.8 | 195.3 | 8,700 | 8,100 | 7,600 | 6,800 | | 130 | |
| 135 | 58.6 | 197.7 | 7,500 | 7,000 | 6,500 | 6,000 | 62.3 | 191.9 | 8,000 | 7,500 | 7,000 | 6,600 | | 135 | |
| 140 | 57.0 | 194.2 | 6,900 | 6,500 | 6,000 | 5,600 | 60.7 | 188.2 | 7,400 | 7,000 | 6,500 | 6,100 | | 140 | |
| 145 | 55.5 | 190.5 | 6,400 | 6,000 | 5,600 | 5,200 | 59.1 | 184.4 | 6,900 | 6,500 | 6,000 | 5,700 | | 145 | |
| 150 | 53.9 | 186.6 | 5,900 | 5,500 | 5,200 | 4,800 | 57.5 | 180.3 | 6,400 | 6,000 | 5,600 | 5,200 | | 150 | |
| 155 | 52.3 | 182.4 | 5,500 | 5,100 | 4,800 | 4,400 | 55.8 | 176.0 | 5,900 | 5,500 | 5,200 | 4,800 | | 155 | |
| 160 | 50.6 | 178.0 | 5,100 | 4,700 | 4,400 | 4,100 | 54.1 | 171.4 | 5,500 | 5,100 | 4,800 | 4,500 | | 160 | |
| 165 | 48.9 | 173.3 | 4,700 | 4,400 | 4,100 | 3,800 | 52.3 | 166.5 | 5,100 | 4,700 | 4,400 | 4,100 | | 165 | |
| 170 | 47.2 | 168.3 | 4,300 | 4,000 | 3,800 | 3,500 | 50.5 | 161.4 | 4,700 | 4,400 | 4,100 | 3,800 | | 170 | |
| 175 | 45.4 | 163.1 | 4,000 | 3,700 | 3,400 | 3,200 | 48.6 | 155.8 | 4,300 | 4,000 | 3,700 | 3,500 | | 175 | |
| 180 | 43.5 | 157.4 | 3,700 | 3,400 | 3,200 | 2,900 | 46.6 | 149.9 | 3,900 | 3,700 | 3,400 | 3,200 | | 180 | |
| 185 | 41.6 | 151.4 | 3,400 | 3,100 | 2,900 | 2,700 | 44.6 | 143.5 | 3,600 | 3,400 | 3,100 | 2,900 | | 185 | |
| 190 | 39.6 | 144.9 | 3,100 | 2,800 | 2,600 | 2,400 | 42.4 | 136.7 | 3,300 | 3,100 | 2,800 | 2,600 | | 190 | |
| 195 | 37.4 | 137.9 | 2,800 | 2,600 | 2,400 | 2,200 | 40.2 | 129.2 | 3,000 | 2,800 | 2,600 | 2,400 | | 195 | |
| 200 | 35.2 | 130.3 | 2,400 | 2,200 | 2,100 | 2,000 | 37.7 | 121.1 | 2,600 | 2,500 | 2,300 | 2,100 | | 200 | |
| 205 | 32.8 | 122.0 | 2,000 | | | | 35.1 | 112.0 | 2,200 | 2,100 | 2,000 | | | 205 | |

MLC90A-1 S-2

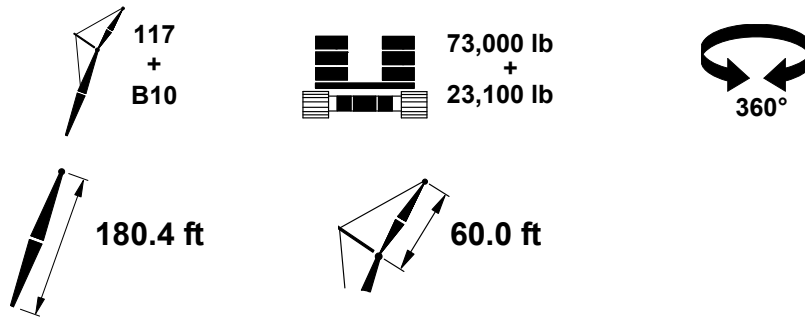

| | 10° | | | 30° | | | |
|-----|------|-------|--------|------|-------|--------|-----|
| | ft | ° | ft | lb | ft | lb | |
| 55 | 80.7 | 242.5 | 17,700 | | | | 55 |
| 60 | 79.5 | 241.4 | 17,500 | | | | 60 |
| 65 | 78.3 | 240.2 | 17,400 | | | | 65 |
| 70 | 77.0 | 238.8 | 17,100 | | | | 70 |
| 75 | 75.8 | 237.3 | 17,000 | 79.8 | 232.2 | 12,600 | 75 |
| 80 | 74.5 | 235.8 | 16,800 | 78.5 | 230.6 | 12,300 | 80 |
| 85 | 73.3 | 234.1 | 16,400 | 77.2 | 228.9 | 11,900 | 85 |
| 90 | 72.0 | 232.2 | 15,000 | 75.9 | 227.0 | 11,600 | 90 |
| 95 | 70.7 | 230.3 | 13,800 | 74.6 | 225.0 | 11,300 | 95 |
| 100 | 69.5 | 228.2 | 12,600 | 73.3 | 222.8 | 11,100 | 100 |
| 105 | 68.2 | 225.9 | 11,600 | 72.0 | 220.6 | 10,800 | 105 |
| 110 | 66.8 | 223.6 | 10,700 | 70.6 | 218.1 | 10,600 | 110 |
| 115 | 65.5 | 221.1 | 9,900 | 69.2 | 215.6 | 10,300 | 115 |
| 120 | 64.2 | 218.4 | 9,100 | 67.9 | 212.8 | 9,900 | 120 |
| 125 | 62.8 | 215.6 | 8,400 | 66.5 | 210.0 | 9,100 | 125 |
| 130 | 61.4 | 212.7 | 7,800 | 65.0 | 206.9 | 8,400 | 130 |
| 135 | 60.0 | 209.5 | 7,200 | 63.6 | 203.7 | 7,800 | 135 |
| 140 | 58.6 | 206.2 | 6,700 | 62.1 | 200.3 | 7,200 | 140 |
| 145 | 57.1 | 202.7 | 6,100 | 60.6 | 196.7 | 6,700 | 145 |
| 150 | 55.7 | 199.0 | 5,700 | 59.1 | 192.9 | 6,200 | 150 |
| 155 | 54.2 | 195.2 | 5,200 | 57.6 | 188.9 | 5,700 | 155 |
| 160 | 52.6 | 191.1 | 4,800 | 56.0 | 184.6 | 5,300 | 160 |
| 165 | 51.0 | 186.7 | 4,400 | 54.3 | 180.1 | 4,800 | 165 |
| 170 | 49.4 | 182.1 | 4,100 | 52.7 | 175.3 | 4,400 | 170 |
| 175 | 47.8 | 177.3 | 3,700 | 50.9 | 170.3 | 4,100 | 175 |
| 180 | 46.1 | 172.1 | 3,400 | 49.1 | 164.9 | 3,700 | 180 |
| 185 | 44.3 | 166.6 | 3,100 | 47.3 | 159.2 | 3,400 | 185 |
| 190 | 42.5 | 160.8 | 2,800 | 45.4 | 153.0 | 3,100 | 190 |
| 195 | 40.6 | 154.6 | 2,500 | 43.4 | 146.5 | 2,800 | 195 |
| 200 | 38.6 | 147.9 | 2,100 | 41.3 | 139.4 | 2,500 | 200 |
| 205 | | | | 39.0 | 131.7 | 2,100 | 205 |

MLC90A-1 S-2

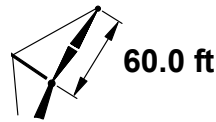
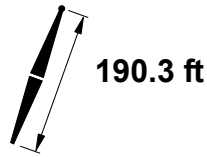
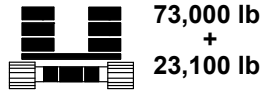
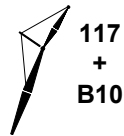

| | 10° | | | 30° | | | |
|-----|------|-------|--------|------|-------|--------|-----|
| | ft | ° | ft | lb | ft | lb | |
| 60 | 79.9 | 251.5 | 16,700 | | | | 60 |
| 65 | 78.7 | 250.3 | 16,500 | | | | 65 |
| 70 | 77.6 | 249.0 | 16,400 | | | | 70 |
| 75 | 76.4 | 247.6 | 16,200 | 80.2 | 242.4 | 12,700 | 75 |
| 80 | 75.2 | 246.1 | 16,000 | 79.0 | 240.9 | 12,400 | 80 |
| 85 | 74.0 | 244.5 | 15,900 | 77.8 | 239.2 | 12,100 | 85 |
| 90 | 72.8 | 242.7 | 14,700 | 76.5 | 237.4 | 11,800 | 90 |
| 95 | 71.5 | 240.8 | 13,500 | 75.3 | 235.5 | 11,500 | 95 |
| 100 | 70.3 | 238.8 | 12,400 | 74.0 | 233.5 | 11,200 | 100 |
| 105 | 69.1 | 236.7 | 11,300 | 72.7 | 231.3 | 11,000 | 105 |
| 110 | 67.8 | 234.5 | 10,400 | 71.5 | 229.0 | 10,700 | 110 |
| 115 | 66.6 | 232.1 | 9,600 | 70.2 | 226.6 | 10,500 | 115 |
| 120 | 65.3 | 229.6 | 8,800 | 68.9 | 224.0 | 9,600 | 120 |
| 125 | 64.0 | 226.9 | 8,100 | 67.5 | 221.2 | 8,900 | 125 |
| 130 | 62.7 | 224.1 | 7,500 | 66.2 | 218.4 | 8,200 | 130 |
| 135 | 61.3 | 221.1 | 6,900 | 64.8 | 215.3 | 7,600 | 135 |
| 140 | 60.0 | 218.0 | 6,400 | 63.4 | 212.1 | 7,000 | 140 |
| 145 | 58.6 | 214.7 | 5,900 | 62.0 | 208.7 | 6,400 | 145 |
| 150 | 57.2 | 211.2 | 5,400 | 60.6 | 205.1 | 5,900 | 150 |
| 155 | 55.8 | 207.6 | 5,000 | 59.1 | 201.4 | 5,500 | 155 |
| 160 | 54.4 | 203.7 | 4,500 | 57.6 | 197.4 | 5,000 | 160 |
| 165 | 52.9 | 199.7 | 4,200 | 56.1 | 193.2 | 4,600 | 165 |
| 170 | 51.4 | 195.4 | 3,800 | 54.6 | 188.8 | 4,200 | 170 |
| 175 | 49.9 | 190.9 | 3,400 | 53.0 | 184.1 | 3,800 | 175 |
| 180 | 48.3 | 186.1 | 3,100 | 51.3 | 179.2 | 3,500 | 180 |
| 185 | 46.7 | 181.1 | 2,800 | 49.6 | 173.9 | 3,100 | 185 |
| 190 | 45.0 | 175.8 | 2,500 | 47.9 | 168.3 | 2,800 | 190 |
| 195 | 43.3 | 170.1 | 2,200 | 46.1 | 162.4 | 2,500 | 195 |
| 200 | | | | 44.2 | 156.1 | 2,200 | 200 |