

Liftcrane Boom Capacities With Luffing Jib Attached

MLC300 SERIES 3

Boom No. B10:500
Luffing Jib No. LJ10:501
474,400 lb VPC (Variable Position Counterweight)
360 Degree Rating

 **LIFTING CAPACITIES:** Lifting capacities for various boom lengths, luffing jib lengths, boom-to-luffing jib angles, and boom operating radii are for freely suspended loads and may be based on percent of static tipping or strength of structural components. Capacities must be reduced by applicable deducts.

Weight of all load blocks, hooks, weight ball, slings, hoist lines, etc., beneath boom point sheaves, is considered part of load. Weight of luffing jib and 11,000 lb suspended beneath luffing jib point sheaves have been included in capacity determination. Boom is not to be lowered beyond radii where combined weights are greater than rated capacity. Where no capacity is shown, operation is not intended or approved.

OPERATING CONDITIONS: Machine to operate on a firm, level, and uniformly supporting surface. Supporting surface and bearing turntable are to be level within a tolerance of 1/2 in. in 10 ft. During operation, luffing jib must be maintained at proper boom-to-luffing jib angle shown in table. Refer to Luffing Jib Rigging **No. 81023383**, Wire Rope Specifications chart **No. 9813-A**, Counterweight Arrangements chart **No. 9345-A**, Luffing Jib Raising Procedure chart **No. 9380-A**, and Wind Conditions chart **No. 9371-A**. Crane operator judgment must be used to allow for dynamic load effects of swinging, hoisting or lowering, travel, wind conditions, as well as adverse operating conditions and physical machine depreciation. Refer to the Operator Manual for operating guidelines.

MACHINE TRAVEL: Machine to travel on a firm, level, and uniformly supporting surface. Boom and luffing jib must be within angle range shown in capacity chart. Refer to Maximum Allowable Travel Specifications chart **No. 9372-A**.

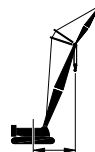

OPERATING RADIUS: Operating radius is horizontal distance from axis of rotation to center of vertical hoist line or load block.



BOOM ANGLE: Boom angle in degrees (°) is angle between horizontal and centerline of boom butt and inserts, and is an indication of operating radius. In all cases, operating radius shall govern capacity.











BOOM POINT ELEVATION: Boom point elevation is vertical distance from ground level to centerline of boom point shaft.

MACHINE EQUIPMENT: Machine equipped with 31 ft 10 in. crawlers, 48 in. or 60 in. treads, 30 ft live mast, 24 part boom hoist reeving, boom support straps, 14 part luffing jib hoist reeving, luffing jib and backstay support straps, and 474,400 lb VPC.

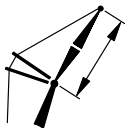
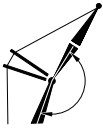
Consult chart **No. 9376-A** for luffing jib capacities.

Luffing Jib Position During Operation	
Luffing Jib Length Feet	Boom-to-Luffing Jib Angle Degrees
78.7 - 98.4	140
118.1 - 157.5	155
177.2 - 315.0	169

Explanation of Symbols

-  LJ10 Luffing Jib No. LJ10:501
+
B10 Boom No. B10:500
-  VPC (Variable Position Counterweight)
-  360°
360 Degree Rating
-  Luffing Jib Length
-  Boom-to-Luffing Jib Angle
-  Boom Length
-  Operating Radius
(see page 1)
-  Boom Angle
(see page 1)
-  Boom Point Elevation
(see page 1)
-  Lifting Capacities
(see page 1)

MLC300 S-3

ASME B30.5

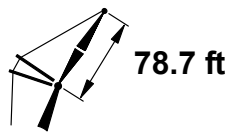
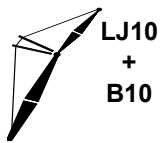

98.4 ft			
ft	°	ft	lb
18	84.5	104.8	588,100
19	83.9	104.6	588,100
20	83.3	104.5	588,100
21	82.7	104.3	588,100
22	82.1	104.2	588,100
24	80.9	103.8	588,100
26	79.8	103.4	575,000
28	78.6	102.9	541,700
30	77.4	102.4	512,000
32	76.2	101.9	475,700
34	74.9	101.3	436,100
36	73.7	100.6	401,600
38	72.5	99.9	371,200
40	71.3	99.2	344,300
45	68.1	97.1	288,700
50	64.9	94.8	245,400
55	61.6	92.0	210,600
60	58.1	88.8	182,000
65	54.5	85.2	158,100
70	50.8	81.1	137,700
75	46.8	76.4	120,100
80	42.5	71.0	104,700

118.1 ft			
ft	°	ft	lb
19	84.9	124.5	585,000
20	84.4	124.4	581,500
21	83.9	124.2	578,100
22	83.5	124.1	574,700
24	82.5	123.8	568,300
26	81.5	123.4	562,500
28	80.5	123.0	530,900
30	79.5	122.6	502,600
32	78.5	122.2	471,200
34	77.5	121.7	432,000
36	76.5	121.2	397,800
38	75.5	120.6	367,700
40	74.5	120.0	341,100
45	71.9	118.3	286,000
50	69.3	116.4	243,200
55	66.7	114.2	208,800
60	64.0	111.7	180,600
65	61.2	108.9	157,100
70	58.4	105.8	137,100
75	55.4	102.3	119,900
80	52.3	98.5	104,900
85	49.1	94.1	91,700
90	45.7	89.2	80,000
95	42.1	83.7	69,500

137.8 ft			
ft	°	ft	lb
21	84.8	144.1	529,400
22	84.4	143.9	526,300
24	83.6	143.7	520,300
26	82.7	143.4	514,600
28	81.9	143.1	509,400
30	81.0	142.7	490,600
32	80.2	142.3	466,300
34	79.3	141.9	428,200
36	78.5	141.5	394,200
38	77.6	141.0	364,300
40	76.8	140.5	337,900
45	74.6	139.1	283,200
50	72.4	137.4	240,700
55	70.2	135.6	206,600
60	68.0	133.5	178,700
65	65.7	131.2	155,400
70	63.3	128.7	135,600
75	61.0	125.9	118,600
80	58.5	122.8	103,900
85	56.0	119.4	90,900
90	53.4	115.7	79,400
95	50.7	111.5	69,200
100	47.9	107.0	60,000
105	45.0	102.0	51,600
110	41.9	96.4	44,000

MLC300 S-3

ASME B30.5

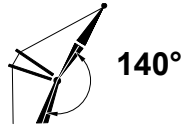
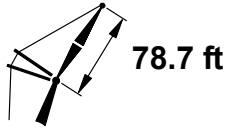
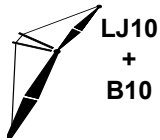

ft	°	ft	lb
24	84.4	163.5	479,400
26	83.6	163.3	474,500
28	82.9	163.0	469,800
30	82.2	162.7	465,400
32	81.4	162.3	449,300
34	80.7	162.0	424,300
36	79.9	161.6	390,500
38	79.2	161.2	360,800
40	78.5	160.7	334,400
45	76.6	159.5	280,100
50	74.7	158.1	237,700
55	72.8	156.5	203,900
60	70.9	154.8	176,100
65	68.9	152.8	152,900
70	66.9	150.6	133,300
75	64.9	148.3	116,500
80	62.9	145.7	101,800
85	60.8	142.8	89,000
90	58.6	139.8	77,600
95	56.5	136.4	67,500
100	54.2	132.8	58,400
105	51.9	128.9	50,200
110	49.5	124.6	42,800
115	47.0	119.9	36,000
120	44.4	114.8	29,700
125	41.7	109.2	23,900

REFERENCE ONLY!

MLC300 S-3

ASME B30.5

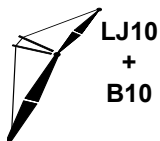

474,400 lb

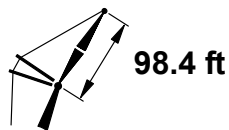

98.4 ft



140°

98.4 ft			
ft	o	ft	lb
18	84.5	104.8	588,100
19	83.9	104.6	588,100
20	83.3	104.5	588,100
21	82.7	104.3	588,100
22	82.1	104.2	588,100
24	80.9	103.8	585,500
26	79.8	103.4	575,000
28	78.6	102.9	541,700
30	77.4	102.4	498,600
32	76.2	101.9	453,900
34	74.9	101.3	415,300
36	73.7	100.6	381,700
38	72.5	99.9	352,100
40	71.3	99.2	325,900
45	68.1	97.1	271,800
50	64.9	94.8	229,600
55	61.6	92.0	195,700
60	58.1	88.8	168,000
65	54.5	85.2	144,700
70	50.8	81.1	125,000
75	46.8	76.4	107,900
80	42.5	71.0	93,100

118.1 ft			
ft	o	ft	lb
19	84.9	124.5	570,700
20	84.4	124.4	567,100
21	83.9	124.2	563,600
22	83.5	124.1	560,200
24	82.5	123.8	553,900
26	81.5	123.4	547,800
28	80.5	123.0	530,900
30	79.5	122.6	494,400
32	78.5	122.2	450,100
34	77.5	121.7	411,800
36	76.5	121.2	378,500
38	75.5	120.6	349,200
40	74.5	120.0	323,200
45	71.9	118.3	269,600
50	69.3	116.4	227,900
55	66.7	114.2	194,500
60	64.0	111.7	167,100
65	61.2	108.9	144,200
70	58.4	105.8	124,800
75	55.4	102.3	108,100
80	52.3	98.5	93,600
85	49.1	94.1	80,800
90	45.7	89.2	69,500
95	42.1	83.7	59,300

137.8 ft			
ft	o	ft	lb
21	84.8	144.1	516,300
22	84.4	143.9	513,200
24	83.6	143.7	507,100
26	82.7	143.4	501,500
28	81.9	143.1	496,200
30	81.0	142.7	490,500
32	80.2	142.3	446,500
34	79.3	141.9	408,500
36	78.5	141.5	375,400
38	77.6	141.0	346,300
40	76.8	140.5	320,500
45	74.6	139.1	267,300
50	72.4	137.4	225,900
55	70.2	135.6	192,700
60	68.0	133.5	165,500
65	65.7	131.2	142,800
70	63.3	128.7	123,600
75	61.0	125.9	107,100
80	58.5	122.8	92,800
85	56.0	119.4	80,200
90	53.4	115.7	69,100
95	50.7	111.5	59,200
100	47.9	107.0	50,200
105	45.0	102.0	42,200
110	41.9	96.4	34,800

MLC300 S-3

ASME B30.5

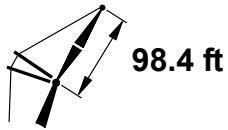
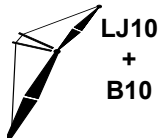

ft	°	ft	lb
24	84.4	163.5	467,900
26	83.6	163.3	463,000
28	82.9	163.0	458,400
30	82.2	162.7	452,700
32	81.4	162.3	433,600
34	80.7	162.0	404,900
36	79.9	161.6	372,000
38	79.2	161.2	343,000
40	78.5	160.7	317,400
45	76.6	159.5	264,400
50	74.7	158.1	223,200
55	72.8	156.5	190,200
60	70.9	154.8	163,200
65	68.9	152.8	140,700
70	66.9	150.6	121,600
75	64.9	148.3	105,200
80	62.9	145.7	91,000
85	60.8	142.8	78,500
90	58.6	139.8	67,500
95	56.5	136.4	57,700
100	54.2	132.8	48,900
105	51.9	128.9	40,900
110	49.5	124.6	33,700
115	47.0	119.9	27,100
120	44.4	114.8	21,100
125	41.7	109.2	15,500

REFERENCE ONLY!

MLC300 S-3

ASME B30.5

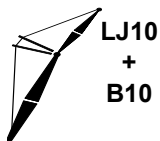

474,400 lb

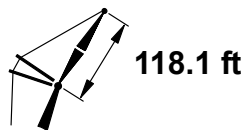

118.1 ft

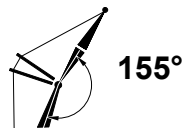

155°

98.4 ft

	ft	°	ft	lb
18	84.5	104.8	588,100	
19	83.9	104.6	588,100	
20	83.3	104.5	588,100	
21	82.7	104.3	588,100	
22	82.1	104.2	588,100	
24	80.9	103.8	586,200	
26	79.8	103.4	575,000	
28	78.6	102.9	541,700	
30	77.4	102.4	502,600	
32	76.2	101.9	456,600	
34	74.9	101.3	417,000	
36	73.7	100.6	382,400	
38	72.5	99.9	352,000	
40	71.3	99.2	325,100	
45	68.1	97.1	269,500	
50	64.9	94.8	226,100	
55	61.6	92.0	191,200	
60	58.1	88.8	162,600	
65	54.5	85.2	138,700	
70	50.8	81.1	118,300	
75	46.8	76.4	100,600	
80	42.5	71.0	85,200	
85	37.8	64.6	71,500	
90	32.4	56.9	59,200	
95	26.0	47.1	47,800	

118.1 ft

	ft	°	ft	lb
19	84.9	124.5	573,400	
20	84.4	124.4	569,500	
21	83.9	124.2	565,800	
22	83.5	124.1	562,200	
24	82.5	123.8	555,200	
26	81.5	123.4	548,700	
28	80.5	123.0	530,900	
30	79.5	122.6	499,800	
32	78.5	122.2	454,300	
34	77.5	121.7	415,000	
36	76.5	121.2	380,800	
38	75.5	120.6	350,700	
40	74.5	120.0	324,100	
45	71.9	118.3	269,000	
50	69.3	116.4	226,100	
55	66.7	114.2	191,800	
60	64.0	111.7	163,600	
65	61.2	108.9	140,000	
70	58.4	105.8	120,000	
75	55.4	102.3	102,800	
80	52.3	98.5	87,800	
85	49.1	94.1	74,600	
90	45.7	89.2	62,900	
95	42.1	83.7	52,400	
100	38.2	77.4	42,900	
105	33.9	70.1	34,200	
110	29.0	61.3	26,100	

137.8 ft

	ft	°	ft	lb
21	84.8	144.1	518,300	
22	84.4	143.9	515,000	
24	83.6	143.7	508,600	
26	82.7	143.4	502,600	
28	81.9	143.1	496,900	
30	81.0	142.7	490,600	
32	80.2	142.3	451,700	
34	79.3	141.9	412,700	
36	78.5	141.5	378,800	
38	77.6	141.0	348,900	
40	76.8	140.5	322,400	
45	74.6	139.1	267,800	
50	72.4	137.4	225,300	
55	70.2	135.6	191,200	
60	68.0	133.5	163,300	
65	65.7	131.2	140,000	
70	63.3	128.7	120,200	
75	61.0	125.9	103,200	
80	58.5	122.8	88,500	
85	56.0	119.4	75,500	
90	53.4	115.7	64,000	
95	50.7	111.5	53,800	
100	47.9	107.0	44,600	
105	45.0	102.0	36,200	
110	41.9	96.4	28,600	
115	38.5	90.2	21,600	
120	34.9	83.1	15,100	
125	31.0	75.0	9,100	
130	26.4	65.2	3,400	

MLC300 S-3

ASME B30.5

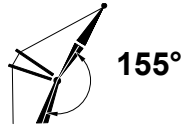
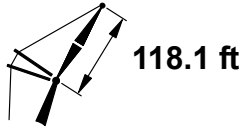
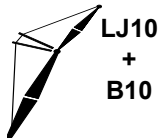

 157.5 ft			
ft	°	ft	lb
24	84.4	163.5	468,900
26	83.6	163.3	463,600
28	82.9	163.0	458,700
30	82.2	162.7	454,100
32	81.4	162.3	438,100
34	80.7	162.0	410,000
36	79.9	161.6	376,200
38	79.2	161.2	346,500
40	78.5	160.7	320,200
45	76.6	159.5	265,800
50	74.7	158.1	223,500
55	72.8	156.5	189,600
60	70.9	154.8	161,900
65	68.9	152.8	138,700
70	66.9	150.6	119,100
75	64.9	148.3	102,300
80	62.9	145.7	87,700
85	60.8	142.8	74,800
90	58.6	139.8	63,500
95	56.5	136.4	53,400
100	54.2	132.8	44,300
105	51.9	128.9	36,100
110	49.5	124.6	28,600
115	47.0	119.9	21,800
120	44.4	114.8	15,600
125	41.7	109.2	9,800
130	38.8	103.0	4,400

REFERENCE ONLY!

MLC300 S-3

ASME B30.5

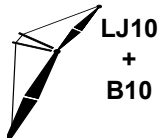

474,400 lb

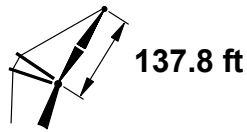

137.8 ft

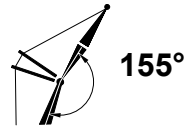

155°

98.4 ft

	ft	°	ft	lb
18	84.5	104.8	588,100	
19	83.9	104.6	588,100	
20	83.3	104.5	585,700	
21	82.7	104.3	582,100	
22	82.1	104.2	578,700	
24	80.9	103.8	572,000	
26	79.8	103.4	565,800	
28	78.6	102.9	534,600	
30	77.4	102.4	481,600	
32	76.2	101.9	436,500	
34	74.9	101.3	397,600	
36	73.7	100.6	363,700	
38	72.5	99.9	333,900	
40	71.3	99.2	307,500	
45	68.1	97.1	252,900	
50	64.9	94.8	210,400	
55	61.6	92.0	176,200	
60	58.1	88.8	148,200	
65	54.5	85.2	124,800	
70	50.8	81.1	104,800	
75	46.8	76.4	87,600	
80	42.5	71.0	72,600	
85	37.8	64.6	59,200	
90	32.4	56.9	47,300	
95	26.0	47.1	36,300	

118.1 ft

	ft	°	ft	lb
19	84.9	124.5	560,500	
20	84.4	124.4	556,600	
21	83.9	124.2	552,800	
22	83.5	124.1	549,100	
24	82.5	123.8	542,000	
26	81.5	123.4	535,300	
28	80.5	123.0	529,000	
30	79.5	122.6	479,800	
32	78.5	122.2	435,100	
34	77.5	121.7	396,600	
36	76.5	121.2	363,000	
38	75.5	120.6	333,500	
40	74.5	120.0	307,400	
45	71.9	118.3	253,400	
50	69.3	116.4	211,300	
55	66.7	114.2	177,700	
60	64.0	111.7	150,000	
65	61.2	108.9	127,000	
70	58.4	105.8	107,400	
75	55.4	102.3	90,600	
80	52.3	98.5	75,900	
85	49.1	94.1	63,000	
90	45.7	89.2	51,600	
95	42.1	83.7	41,300	
100	38.2	77.4	32,100	
105	33.9	70.1	23,600	
110	29.0	61.3	15,800	

137.8 ft

	ft	°	ft	lb
21	84.8	144.1	506,700	
22	84.4	143.9	503,300	
24	83.6	143.7	496,800	
26	82.7	143.4	490,700	
28	81.9	143.1	485,000	
30	81.0	142.7	477,600	
32	80.2	142.3	433,300	
34	79.3	141.9	395,000	
36	78.5	141.5	361,700	
38	77.6	141.0	332,400	
40	76.8	140.5	306,400	
45	74.6	139.1	252,800	
50	72.4	137.4	211,100	
55	70.2	135.6	177,700	
60	68.0	133.5	150,400	
65	65.7	131.2	127,500	
70	63.3	128.7	108,200	
75	61.0	125.9	91,600	
80	58.5	122.8	77,100	
85	56.0	119.4	64,400	
90	53.4	115.7	53,200	
95	50.7	111.5	43,200	
100	47.9	107.0	34,200	
105	45.0	102.0	26,100	
110	41.9	96.4	18,700	
115	38.5	90.2	11,900	
120	34.9	83.1	5,600	

MLC300 S-3

ASME B30.5

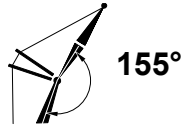
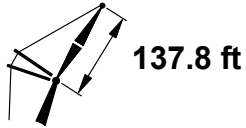
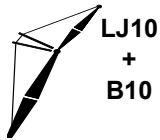

 157.5 ft			
ft	°	ft	lb
24	84.4	163.5	458,100
26	83.6	163.3	452,800
28	82.9	163.0	447,800
30	82.2	162.7	443,100
32	81.4	162.3	425,900
34	80.7	162.0	392,800
36	79.9	161.6	359,600
38	79.2	161.2	330,500
40	78.5	160.7	304,600
45	76.6	159.5	251,400
50	74.7	158.1	209,900
55	72.8	156.5	176,700
60	70.9	154.8	149,500
65	68.9	152.8	126,800
70	66.9	150.6	107,600
75	64.9	148.3	91,100
80	62.9	145.7	76,800
85	60.8	142.8	64,200
90	58.6	139.8	53,100
95	56.5	136.4	43,200
100	54.2	132.8	34,300
105	51.9	128.9	26,300
110	49.5	124.6	19,100
115	47.0	119.9	12,400
120	44.4	114.8	6,300

REFERENCE ONLY!

MLC300 S-3

ASME B30.5

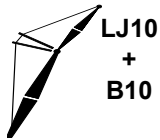

474,400 lb



360°

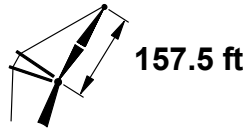

157.5 ft

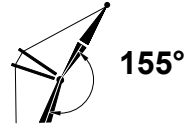

155°

98.4 ft

	ft	o	ft	lb
18	84.5	104.8	577,700	
19	83.9	104.6	573,700	
20	83.3	104.5	569,800	
21	82.7	104.3	566,100	
22	82.1	104.2	562,500	
24	80.9	103.8	555,500	
26	79.8	103.4	549,100	
28	78.6	102.9	509,900	
30	77.4	102.4	458,100	
32	76.2	101.9	413,900	
34	74.9	101.3	375,900	
36	73.7	100.6	342,700	
38	72.5	99.9	313,500	
40	71.3	99.2	287,700	
45	68.1	97.1	234,300	
50	64.9	94.8	192,800	
55	61.6	92.0	159,500	
60	58.1	88.8	132,100	
65	54.5	85.2	109,300	
70	50.8	81.1	89,800	
75	46.8	76.4	73,100	
80	42.5	71.0	58,500	
85	37.8	64.6	45,600	
90	32.4	56.9	34,100	
95	26.0	47.1	23,600	

118.1 ft

	ft	o	ft	lb
19	84.9	124.5	545,500	
20	84.4	124.4	541,500	
21	83.9	124.2	537,600	
22	83.5	124.1	533,800	
24	82.5	123.8	526,600	
26	81.5	123.4	519,700	
28	80.5	123.0	508,600	
30	79.5	122.6	457,300	
32	78.5	122.2	413,600	
34	77.5	121.7	375,900	
36	76.5	121.2	343,100	
38	75.5	120.6	314,200	
40	74.5	120.0	288,600	
45	71.9	118.3	235,900	
50	69.3	116.4	194,800	
55	66.7	114.2	161,900	
60	64.0	111.7	134,900	
65	61.2	108.9	112,400	
70	58.4	105.8	93,300	
75	55.4	102.3	76,900	
80	52.3	98.5	62,600	
85	49.1	94.1	50,100	
90	45.7	89.2	39,000	
95	42.1	83.7	29,100	
100	38.2	77.4	20,100	
105	33.9	70.1	12,000	
110	29.0	61.3	4,500	

137.8 ft

	ft	o	ft	lb
21	84.8	144.1	492,900	
22	84.4	143.9	489,400	
24	83.6	143.7	482,900	
26	82.7	143.4	476,700	
28	81.9	143.1	470,800	
30	81.0	142.7	455,900	
32	80.2	142.3	412,500	
34	79.3	141.9	375,100	
36	78.5	141.5	342,500	
38	77.6	141.0	313,800	
40	76.8	140.5	288,500	
45	74.6	139.1	236,100	
50	72.4	137.4	195,300	
55	70.2	135.6	162,700	
60	68.0	133.5	136,000	
65	65.7	131.2	113,700	
70	63.3	128.7	94,800	
75	61.0	125.9	78,600	
80	58.5	122.8	64,500	
85	56.0	119.4	52,200	
90	53.4	115.7	41,200	
95	50.7	111.5	31,500	
100	47.9	107.0	22,800	
105	45.0	102.0	14,900	
110	41.9	96.4	7,700	

MLC300 S-3

ASME B30.5

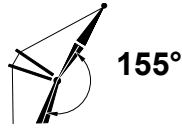
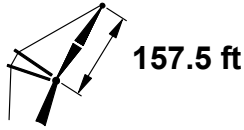
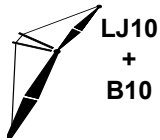

 157.5 ft			
ft	°	ft	lb
24	84.4	163.5	445,500
26	83.6	163.3	440,200
28	82.9	163.0	435,200
30	82.2	162.7	430,400
32	81.4	162.3	410,700
34	80.7	162.0	373,500
36	79.9	161.6	341,000
38	79.2	161.2	312,500
40	78.5	160.7	287,300
45	76.6	159.5	235,200
50	74.7	158.1	194,700
55	72.8	156.5	162,200
60	70.9	154.8	135,700
65	68.9	152.8	113,500
70	66.9	150.6	94,700
75	64.9	148.3	78,600
80	62.9	145.7	64,700
85	60.8	142.8	52,400
90	58.6	139.8	41,600
95	56.5	136.4	32,000
100	54.2	132.8	23,400
105	51.9	128.9	15,600
110	49.5	124.6	8,500
115	47.0	119.9	2,100

REFERENCE ONLY!

MLC300 S-3

ASME B30.5

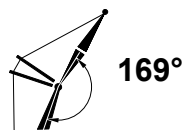
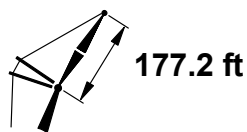
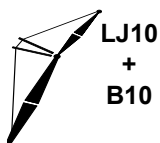

98.4 ft

	ft	o	ft	lb
18	84.5	104.8	588,100	
19	83.9	104.6	588,100	
20	83.3	104.5	588,100	
21	82.7	104.3	584,500	
22	82.1	104.2	580,400	
24	80.9	103.8	572,500	
26	79.8	103.4	565,000	
28	78.6	102.9	540,000	
30	77.4	102.4	484,500	
32	76.2	101.9	437,100	
34	74.9	101.3	396,200	
36	73.7	100.6	360,600	
38	72.5	99.9	329,200	
40	71.3	99.2	301,500	
45	68.1	97.1	244,000	
50	64.9	94.8	199,200	
55	61.6	92.0	163,200	
60	58.1	88.8	133,600	
65	54.5	85.2	108,800	
70	50.8	81.1	87,600	
75	46.8	76.4	69,300	
80	42.5	71.0	53,200	
85	37.8	64.6	38,900	
90	32.4	56.9	25,900	
95	26.0	47.1	13,900	

118.1 ft

	ft	o	ft	lb
19	84.9	124.5	564,800	
20	84.4	124.4	560,400	
21	83.9	124.2	556,000	
22	83.5	124.1	551,800	
24	82.5	123.8	543,700	
26	81.5	123.4	536,000	
28	80.5	123.0	528,700	
30	79.5	122.6	485,700	
32	78.5	122.2	438,800	
34	77.5	121.7	398,400	
36	76.5	121.2	363,200	
38	75.5	120.6	332,200	
40	74.5	120.0	304,700	
45	71.9	118.3	248,000	
50	69.3	116.4	203,800	
55	66.7	114.2	168,300	
60	64.0	111.7	139,200	
65	61.2	108.9	114,900	
70	58.4	105.8	94,200	
75	55.4	102.3	76,400	
80	52.3	98.5	60,900	
85	49.1	94.1	47,200	
90	45.7	89.2	35,000	
95	42.1	83.7	24,100	
100	38.2	77.4	14,200	
105	33.9	70.1	5,000	

137.8 ft

	ft	o	ft	lb
21	84.8	144.1	509,300	
22	84.4	143.9	505,600	
24	83.6	143.7	498,300	
26	82.7	143.4	491,400	
28	81.9	143.1	484,900	
30	81.0	142.7	478,700	
32	80.2	142.3	439,200	
34	79.3	141.9	399,100	
36	78.5	141.5	364,100	
38	77.6	141.0	333,400	
40	76.8	140.5	306,100	
45	74.6	139.1	249,900	
50	72.4	137.4	206,100	
55	70.2	135.6	171,000	
60	68.0	133.5	142,200	
65	65.7	131.2	118,200	
70	63.3	128.7	97,800	
75	61.0	125.9	80,300	
80	58.5	122.8	65,000	
85	56.0	119.4	51,600	
90	53.4	115.7	39,700	
95	50.7	111.5	29,100	
100	47.9	107.0	19,600	
105	45.0	102.0	10,900	
110	41.9	96.4	2,900	

MLC300 S-3

ASME B30.5

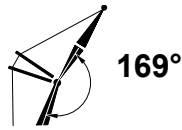
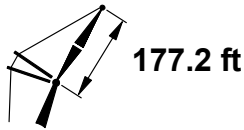
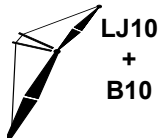

 157.5 ft			
ft	°	ft	lb
24	84.4	163.5	458,500
26	83.6	163.3	452,600
28	82.9	163.0	447,100
30	82.2	162.7	441,800
32	81.4	162.3	427,300
34	80.7	162.0	398,500
36	79.9	161.6	363,800
38	79.2	161.2	333,200
40	78.5	160.7	306,100
45	76.6	159.5	250,200
50	74.7	158.1	206,700
55	72.8	156.5	171,800
60	70.9	154.8	143,200
65	68.9	152.8	119,400
70	66.9	150.6	99,200
75	64.9	148.3	81,800
80	62.9	145.7	66,700
85	60.8	142.8	53,500
90	58.6	139.8	41,800
95	56.5	136.4	31,300
100	54.2	132.8	22,000
105	51.9	128.9	13,500
110	49.5	124.6	5,700

REFERENCE ONLY!

MLC300 S-3

ASME B30.5

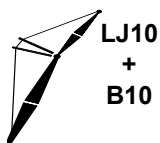

474,400 lb



360°

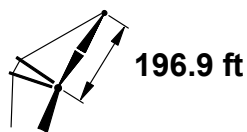

196.9 ft

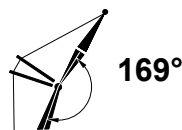

169°

98.4 ft

	ft	o	ft	lb
18	84.5	104.8	586,100	
19	83.9	104.6	583,700	
20	83.3	104.5	579,200	
21	82.7	104.3	574,800	
22	82.1	104.2	570,400	
24	80.9	103.8	562,200	
26	79.8	103.4	554,300	
28	78.6	102.9	523,900	
30	77.4	102.4	468,700	
32	76.2	101.9	421,700	
34	74.9	101.3	381,200	
36	73.7	100.6	345,900	
38	72.5	99.9	314,800	
40	71.3	99.2	287,200	
45	68.1	97.1	230,300	
50	64.9	94.8	185,800	
55	61.6	92.0	150,200	
60	58.1	88.8	120,800	
65	54.5	85.2	96,200	
70	50.8	81.1	75,300	
75	46.8	76.4	57,100	
80	42.5	71.0	41,200	
85	37.8	64.6	27,000	
90	32.4	56.9	14,300	
95	26.0	47.1	2,400	

118.1 ft

	ft	o	ft	lb
19	84.9	124.5	555,900	
20	84.4	124.4	551,300	
21	83.9	124.2	546,800	
22	83.5	124.1	542,500	
24	82.5	123.8	534,100	
26	81.5	123.4	526,200	
28	80.5	123.0	518,600	
30	79.5	122.6	471,200	
32	78.5	122.2	424,700	
34	77.5	121.7	384,600	
36	76.5	121.2	349,700	
38	75.5	120.6	318,900	
40	74.5	120.0	291,700	
45	71.9	118.3	235,500	
50	69.3	116.4	191,600	
55	66.7	114.2	156,500	
60	64.0	111.7	127,700	
65	61.2	108.9	103,600	
70	58.4	105.8	83,100	
75	55.4	102.3	65,500	
80	52.3	98.5	50,100	
85	49.1	94.1	36,500	
90	45.7	89.2	24,500	
95	42.1	83.7	13,700	
100	38.2	77.4	3,900	

137.8 ft

	ft	o	ft	lb
21	84.8	144.1	501,000	
22	84.4	143.9	497,100	
24	83.6	143.7	489,700	
26	82.7	143.4	482,600	
28	81.9	143.1	475,900	
30	81.0	142.7	469,600	
32	80.2	142.3	425,900	
34	79.3	141.9	386,100	
36	78.5	141.5	351,500	
38	77.6	141.0	321,000	
40	76.8	140.5	294,000	
45	74.6	139.1	238,200	
50	72.4	137.4	194,800	
55	70.2	135.6	160,000	
60	68.0	133.5	131,500	
65	65.7	131.2	107,700	
70	63.3	128.7	87,500	
75	61.0	125.9	70,200	
80	58.5	122.8	55,100	
85	56.0	119.4	41,800	
90	53.4	115.7	30,000	
95	50.7	111.5	19,500	
100	47.9	107.0	10,100	
105	45.0	102.0	1,500	

MLC300 S-3

ASME B30.5

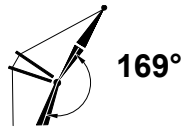
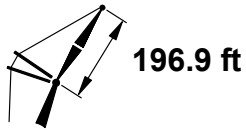
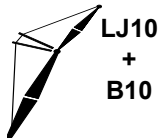

 157.5 ft			
ft	°	ft	lb
24	84.4	163.5	450,600
26	83.6	163.3	444,600
28	82.9	163.0	439,000
30	82.2	162.7	433,600
32	81.4	162.3	418,400
34	80.7	162.0	386,300
36	79.9	161.6	351,800
38	79.2	161.2	321,500
40	78.5	160.7	294,600
45	76.6	159.5	239,200
50	74.7	158.1	196,100
55	72.8	156.5	161,500
60	70.9	154.8	133,200
65	68.9	152.8	109,600
70	66.9	150.6	89,600
75	64.9	148.3	72,400
80	62.9	145.7	57,500
85	60.8	142.8	44,300
90	58.6	139.8	32,800
95	56.5	136.4	22,400
100	54.2	132.8	13,100
105	51.9	128.9	4,700

REFERENCE ONLY!

MLC300 S-3

ASME B30.5

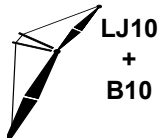

474,400 lb

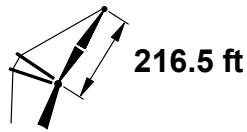

216.5 ft

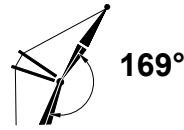

169°

98.4 ft

	ft	°	ft	lb
18	84.5	104.8	576,800	
19	83.9	104.6	572,200	
20	83.3	104.5	567,400	
21	82.7	104.3	562,700	
22	82.1	104.2	558,200	
24	80.9	103.8	549,500	
26	79.8	103.4	541,200	
28	78.6	102.9	505,000	
30	77.4	102.4	450,300	
32	76.2	101.9	403,800	
34	74.9	101.3	363,600	
36	73.7	100.6	328,600	
38	72.5	99.9	297,800	
40	71.3	99.2	270,500	
45	68.1	97.1	214,000	
50	64.9	94.8	170,000	
55	61.6	92.0	134,700	
60	58.1	88.8	105,700	
65	54.5	85.2	81,300	
70	50.8	81.1	60,600	
75	46.8	76.4	42,700	
80	42.5	71.0	26,900	
85	37.8	64.6	13,000	

118.1 ft

	ft	°	ft	lb
19	84.9	124.5	545,200	
20	84.4	124.4	540,500	
21	83.9	124.2	535,800	
22	83.5	124.1	531,400	
24	82.5	123.8	522,700	
26	81.5	123.4	514,500	
28	80.5	123.0	506,600	
30	79.5	122.6	454,200	
32	78.5	122.2	408,100	
34	77.5	121.7	368,400	
36	76.5	121.2	333,800	
38	75.5	120.6	303,300	
40	74.5	120.0	276,400	
45	71.9	118.3	220,700	
50	69.3	116.4	177,300	
55	66.7	114.2	142,500	
60	64.0	111.7	114,000	
65	61.2	108.9	90,100	
70	58.4	105.8	69,800	
75	55.4	102.3	52,400	
80	52.3	98.5	37,200	
85	49.1	94.1	23,800	
90	45.7	89.2	11,900	

137.8 ft

	ft	°	ft	lb
21	84.8	144.1	490,700	
22	84.4	143.9	486,700	
24	83.6	143.7	479,000	
26	82.7	143.4	471,800	
28	81.9	143.1	464,900	
30	81.0	142.7	456,000	
32	80.2	142.3	410,300	
34	79.3	141.9	370,900	
36	78.5	141.5	336,600	
38	77.6	141.0	306,400	
40	76.8	140.5	279,700	
45	74.6	139.1	224,500	
50	72.4	137.4	181,500	
55	70.2	135.6	147,100	
60	68.0	133.5	118,800	
65	65.7	131.2	95,300	
70	63.3	128.7	75,300	
75	61.0	125.9	58,100	
80	58.5	122.8	43,200	
85	56.0	119.4	30,100	
90	53.4	115.7	18,400	
95	50.7	111.5	8,100	

MLC300 S-3

ASME B30.5

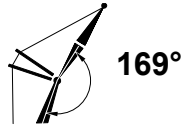
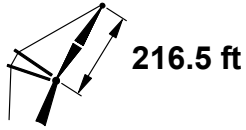
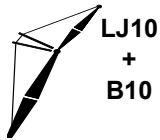

 157.5 ft			
ft	°	ft	lb
24	84.4	163.5	440,900
26	83.6	163.3	434,800
28	82.9	163.0	429,000
30	82.2	162.7	423,500
32	81.4	162.3	407,500
34	80.7	162.0	371,800
36	79.9	161.6	337,700
38	79.2	161.2	307,700
40	78.5	160.7	281,100
45	76.6	159.5	226,200
50	74.7	158.1	183,500
55	72.8	156.5	149,300
60	70.9	154.8	121,300
65	68.9	152.8	97,900
70	66.9	150.6	78,100
75	64.9	148.3	61,100
80	62.9	145.7	46,300
85	60.8	142.8	33,400
90	58.6	139.8	21,900
95	56.5	136.4	11,700
100	54.2	132.8	2,500

REFERENCE ONLY!

MLC300 S-3

ASME B30.5

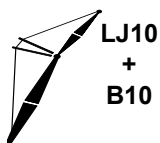

474,400 lb

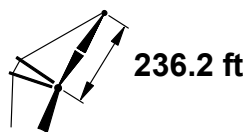

236.2 ft

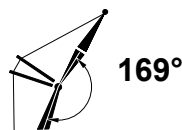

169°

98.4 ft

	ft	°	ft	lb
18	84.5	104.8	566,100	
19	83.9	104.6	561,000	
20	83.3	104.5	555,900	
21	82.7	104.3	551,100	
22	82.1	104.2	546,400	
24	80.9	103.8	537,200	
26	79.8	103.4	528,400	
28	78.6	102.9	486,400	
30	77.4	102.4	432,300	
32	76.2	101.9	386,200	
34	74.9	101.3	346,400	
36	73.7	100.6	311,700	
38	72.5	99.9	281,200	
40	71.3	99.2	254,200	
45	68.1	97.1	198,400	
50	64.9	94.8	154,800	
55	61.6	92.0	119,800	
60	58.1	88.8	91,100	
65	54.5	85.2	67,000	
70	50.8	81.1	46,500	
75	46.8	76.4	28,800	
80	42.5	71.0	13,300	

118.1 ft

	ft	°	ft	lb
19	84.9	124.5	534,600	
20	84.4	124.4	529,800	
21	83.9	124.2	524,900	
22	83.5	124.1	520,300	
24	82.5	123.8	511,300	
26	81.5	123.4	502,800	
28	80.5	123.0	491,100	
30	79.5	122.6	437,600	
32	78.5	122.2	392,000	
34	77.5	121.7	352,600	
36	76.5	121.2	318,400	
38	75.5	120.6	288,200	
40	74.5	120.0	261,500	
45	71.9	118.3	206,400	
50	69.3	116.4	163,500	
55	66.7	114.2	129,100	
60	64.0	111.7	100,800	
65	61.2	108.9	77,200	
70	58.4	105.8	57,200	
75	55.4	102.3	40,000	
80	52.3	98.5	24,900	
85	49.1	94.1	11,700	

137.8 ft

	ft	°	ft	lb
21	84.8	144.1	480,600	
22	84.4	143.9	476,600	
24	83.6	143.7	468,700	
26	82.7	143.4	461,300	
28	81.9	143.1	454,200	
30	81.0	142.7	440,400	
32	80.2	142.3	395,200	
34	79.3	141.9	356,200	
36	78.5	141.5	322,200	
38	77.6	141.0	292,300	
40	76.8	140.5	265,900	
45	74.6	139.1	211,300	
50	72.4	137.4	168,700	
55	70.2	135.6	134,700	
60	68.0	133.5	106,800	
65	65.7	131.2	83,500	
70	63.3	128.7	63,700	
75	61.0	125.9	46,700	
80	58.5	122.8	32,000	
85	56.0	119.4	19,000	
90	53.4	115.7	7,500	

MLC300 S-3

ASME B30.5

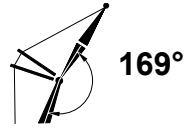
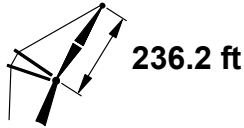
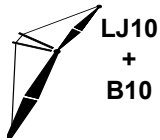

ft	°	ft	lb
24	84.4	163.5	431,800
26	83.6	163.3	425,600
28	82.9	163.0	419,700
30	82.2	162.7	414,100
32	81.4	162.3	394,800
34	80.7	162.0	357,800
36	79.9	161.6	324,100
38	79.2	161.2	294,400
40	78.5	160.7	268,100
45	76.6	159.5	213,800
50	74.7	158.1	171,600
55	72.8	156.5	137,700
60	70.9	154.8	110,000
65	68.9	152.8	86,900
70	66.9	150.6	67,300
75	64.9	148.3	50,500
80	62.9	145.7	35,900
85	60.8	142.8	23,100
90	58.6	139.8	11,800
95	56.5	136.4	1,700

REFERENCE ONLY!

MLC300 S-3

ASME B30.5

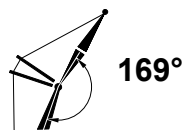
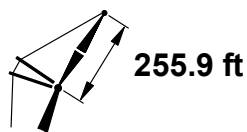
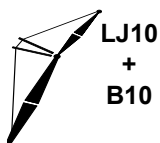

98.4 ft

	ft	o	ft	lb
18	84.5	104.8	553,600	
19	83.9	104.6	548,200	
20	83.3	104.5	542,900	
21	82.7	104.3	537,800	
22	82.1	104.2	532,800	
24	80.9	103.8	523,200	
26	79.8	103.4	514,000	
28	78.6	102.9	465,700	
30	77.4	102.4	412,100	
32	76.2	101.9	366,500	
34	74.9	101.3	327,100	
36	73.7	100.6	292,800	
38	72.5	99.9	262,600	
40	71.3	99.2	235,900	
45	68.1	97.1	180,600	
50	64.9	94.8	137,500	
55	61.6	92.0	103,000	
60	58.1	88.8	74,600	
65	54.5	85.2	50,800	
70	50.8	81.1	30,600	
75	46.8	76.4	13,100	

118.1 ft

	ft	o	ft	lb
19	84.9	124.5	522,500	
20	84.4	124.4	517,400	
21	83.9	124.2	512,500	
22	83.5	124.1	507,700	
24	82.5	123.8	498,400	
26	81.5	123.4	489,500	
28	80.5	123.0	471,800	
30	79.5	122.6	418,900	
32	78.5	122.2	373,800	
34	77.5	121.7	334,900	
36	76.5	121.2	301,000	
38	75.5	120.6	271,200	
40	74.5	120.0	244,800	
45	71.9	118.3	190,300	
50	69.3	116.4	147,800	
55	66.7	114.2	113,800	
60	64.0	111.7	85,900	
65	61.2	108.9	62,600	
70	58.4	105.8	42,800	
75	55.4	102.3	25,800	
80	52.3	98.5	10,900	

137.8 ft

	ft	o	ft	lb
21	84.8	144.1	469,500	
22	84.4	143.9	465,300	
24	83.6	143.7	457,200	
26	82.7	143.4	449,600	
28	81.9	143.1	442,300	
30	81.0	142.7	422,800	
32	80.2	142.3	378,100	
34	79.3	141.9	339,500	
36	78.5	141.5	306,000	
38	77.6	141.0	276,400	
40	76.8	140.5	250,300	
45	74.6	139.1	196,300	
50	72.4	137.4	154,200	
55	70.2	135.6	120,600	
60	68.0	133.5	93,000	
65	65.7	131.2	69,900	
70	63.3	128.7	50,400	
75	61.0	125.9	33,600	
80	58.5	122.8	19,100	
85	56.0	119.4	6,300	

MLC300 S-3

ASME B30.5

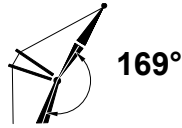
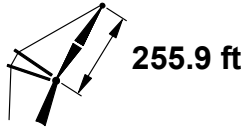
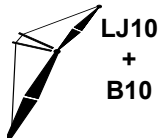

 157.5 ft			
ft	°	ft	lb
24	84.4	163.5	421,100
26	83.6	163.3	414,700
28	82.9	163.0	408,600
30	82.2	162.7	402,200
32	81.4	162.3	380,400
34	80.7	162.0	342,000
36	79.9	161.6	308,600
38	79.2	161.2	279,300
40	78.5	160.7	253,300
45	76.6	159.5	199,700
50	74.7	158.1	157,900
55	72.8	156.5	124,500
60	70.9	154.8	97,100
65	68.9	152.8	74,300
70	66.9	150.6	54,900
75	64.9	148.3	38,300
80	62.9	145.7	23,900
85	60.8	142.8	11,200

REFERENCE ONLY!

MLC300 S-3

ASME B30.5

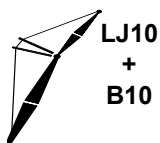

474,400 lb



360°

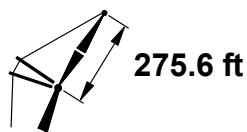

275.6 ft

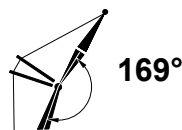

169°

98.4 ft

	ft	°	ft	lb
18	84.5	104.8	542,200	
19	83.9	104.6	536,700	
20	83.3	104.5	531,200	
21	82.7	104.3	525,800	
22	82.1	104.2	520,500	
24	80.9	103.8	510,400	
26	79.8	103.4	500,800	
28	78.6	102.9	445,800	
30	77.4	102.4	392,900	
32	76.2	101.9	347,700	
34	74.9	101.3	308,800	
36	73.7	100.6	274,800	
38	72.5	99.9	245,000	
40	71.3	99.2	218,500	
45	68.1	97.1	163,900	
50	64.9	94.8	121,300	
55	61.6	92.0	87,100	
60	58.1	88.8	59,100	
65	54.5	85.2	35,600	
70	50.8	81.1	15,600	

118.1 ft

	ft	°	ft	lb
19	84.9	124.5	511,500	
20	84.4	124.4	506,300	
21	83.9	124.2	501,200	
22	83.5	124.1	496,200	
24	82.5	123.8	486,600	
26	81.5	123.4	477,400	
28	80.5	123.0	453,400	
30	79.5	122.6	401,100	
32	78.5	122.2	356,500	
34	77.5	121.7	318,000	
36	76.5	121.2	284,500	
38	75.5	120.6	255,100	
40	74.5	120.0	229,000	
45	71.9	118.3	175,100	
50	69.3	116.4	133,100	
55	66.7	114.2	99,500	
60	64.0	111.7	71,900	
65	61.2	108.9	48,900	
70	58.4	105.8	29,400	
75	55.4	102.3	12,600	

137.8 ft

	ft	°	ft	lb
21	84.8	144.1	458,900	
22	84.4	143.9	454,600	
24	83.6	143.7	446,300	
26	82.7	143.4	438,500	
28	81.9	143.1	431,000	
30	81.0	142.7	406,100	
32	80.2	142.3	361,900	
34	79.3	141.9	323,800	
36	78.5	141.5	290,600	
38	77.6	141.0	261,400	
40	76.8	140.5	235,500	
45	74.6	139.1	182,200	
50	72.4	137.4	140,600	
55	70.2	135.6	107,400	
60	68.0	133.5	80,100	
65	65.7	131.2	57,400	
70	63.3	128.7	38,100	
75	61.0	125.9	21,500	
80	58.5	122.8	7,200	

MLC300 S-3

ASME B30.5

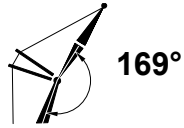
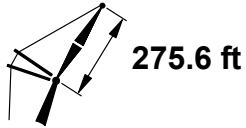
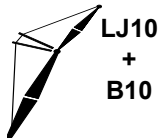

 157.5 ft			
ft	°	ft	lb
24	84.4	163.5	411,100
26	83.6	163.3	404,500
28	82.9	163.0	398,400
30	82.2	162.7	390,800
32	81.4	162.3	365,000
34	80.7	162.0	327,100
36	79.9	161.6	294,100
38	79.2	161.2	265,100
40	78.5	160.7	239,400
45	76.6	159.5	186,400
50	74.7	158.1	145,200
55	72.8	156.5	112,100
60	70.9	154.8	85,100
65	68.9	152.8	62,500
70	66.9	150.6	43,400
75	64.9	148.3	27,000
80	62.9	145.7	12,800

REFERENCE ONLY!

MLC300 S-3

ASME B30.5

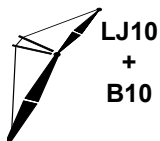

474,400 lb



360°

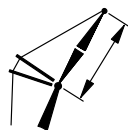

295.3 ft

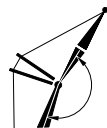

169°

98.4 ft

	ft	o	ft	lb
18	84.5	104.8	528,300	
19	83.9	104.6	522,500	
20	83.3	104.5	516,800	
21	82.7	104.3	511,100	
22	82.1	104.2	505,700	
24	80.9	103.8	495,000	
26	79.8	103.4	484,900	
28	78.6	102.9	474,300	
30	77.4	102.4	463,300	
32	76.2	101.9	452,000	
34	74.9	101.3	440,500	
36	73.7	100.6	428,800	
38	72.5	99.9	416,900	
40	71.3	99.2	404,800	
45	68.1	97.1	376,300	
50	64.9	94.8	347,300	
55	61.6	92.0	317,800	
60	58.1	88.8	287,800	
65	54.5	85.2	257,300	

118.1 ft

	ft	o	ft	lb
19	84.9	124.5	498,100	
20	84.4	124.4	492,700	
21	83.9	124.2	487,500	
22	83.5	124.1	482,300	
24	82.5	123.8	472,300	
26	81.5	123.4	462,700	
28	80.5	123.0	453,500	
30	79.5	122.6	444,800	
32	78.5	122.2	436,600	
34	77.5	121.7	428,900	
36	76.5	121.2	421,700	
38	75.5	120.6	415,000	
40	74.5	120.0	408,800	
45	71.9	118.3	384,300	
50	69.3	116.4	359,300	
55	66.7	114.2	333,800	
60	64.0	111.7	307,800	
65	61.2	108.9	281,300	
70	58.4	105.8	254,300	

137.8 ft

	ft	o	ft	lb
21	84.8	144.1	446,200	
22	84.4	143.9	441,800	
24	83.6	143.7	433,300	
26	82.7	143.4	425,200	
28	81.9	143.1	417,500	
30	81.0	142.7	410,200	
32	80.2	142.3	403,300	
34	79.3	141.9	396,800	
36	78.5	141.5	390,700	
38	77.6	141.0	385,000	
40	76.8	140.5	379,700	
45	74.6	139.1	360,000	
50	72.4	137.4	340,000	
55	70.2	135.6	320,000	
60	68.0	133.5	299,000	
65	65.7	131.2	277,000	
70	63.3	128.7	254,000	
75	61.0	125.9	230,000	

REFERENCE ONLY

MLC300 S-3

ASME B30.5

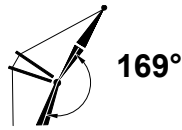
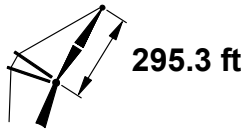
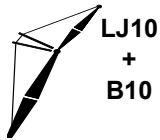

 157.5 ft			
ft	°	ft	lb
24	84.4	163.5	399,300
26	83.6	163.3	392,700
28	82.9	163.0	386,400
30	82.2	162.7	374,900
32	81.4	162.3	347,400
34	80.7	162.0	310,000
36	79.9	161.6	277,400
38	79.2	161.2	248,800
40	78.5	160.7	223,500
45	76.6	159.5	171,100
50	74.7	158.1	130,400
55	72.8	156.5	97,900
60	70.9	154.8	71,200
65	68.9	152.8	48,900
70	66.9	150.6	30,100
75	64.9	148.3	13,900

REFERENCE ONLY!

MLC300 S-3

ASME B30.5

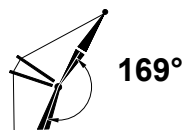
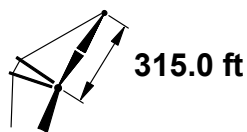
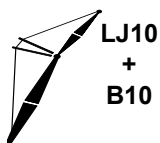

98.4 ft

	ft	°	ft	lb
18	84.5	104.8	514,800	
19	83.9	104.6	508,600	
20	83.3	104.5	502,700	
21	82.7	104.3	496,800	
22	82.1	104.2	491,000	
24	80.9	103.8	479,800	
26	79.8	103.4	462,600	
28	78.6	102.9	401,100	
30	77.4	102.4	349,400	
32	76.2	101.9	305,300	
34	74.9	101.3	267,300	
36	73.7	100.6	234,200	
38	72.5	99.9	205,100	
40	71.3	99.2	179,300	
45	68.1	97.1	126,000	
50	64.9	94.8	84,500	
55	61.6	92.0	51,200	
60	58.1	88.8	23,900	

118.1 ft

	ft	°	ft	lb
19	84.9	124.5	484,900	
20	84.4	124.4	479,400	
21	83.9	124.2	474,000	
22	83.5	124.1	468,600	
24	82.5	123.8	458,200	
26	81.5	123.4	448,300	
28	80.5	123.0	412,000	
30	79.5	122.6	361,000	
32	78.5	122.2	317,500	
34	77.5	121.7	280,000	
36	76.5	121.2	247,300	
38	75.5	120.6	218,600	
40	74.5	120.0	193,200	
45	71.9	118.3	140,700	
50	69.3	116.4	99,800	
55	66.7	114.2	67,100	
60	64.0	111.7	40,300	
65	61.2	108.9	17,900	

137.8 ft

	ft	°	ft	lb
21	84.8	144.1	433,900	
22	84.4	143.9	429,500	
24	83.6	143.7	420,700	
26	82.7	143.4	412,400	
28	81.9	143.1	404,400	
30	81.0	142.7	368,400	
32	80.2	142.3	325,300	
34	79.3	141.9	288,200	
36	78.5	141.5	255,900	
38	77.6	141.0	227,400	
40	76.8	140.5	202,300	
45	74.6	139.1	150,300	
50	72.4	137.4	109,900	
55	70.2	135.6	77,500	
60	68.0	133.5	51,000	
65	65.7	131.2	28,900	
70	63.3	128.7	10,100	

REFERENCE

MLC300 S-3

ASME B30.5

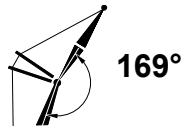
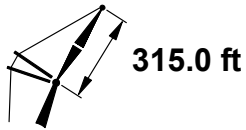
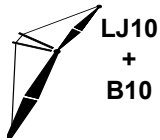

 157.5 ft			
ft	°	ft	lb
24	84.4	163.5	387,500
26	83.6	163.3	380,700
28	82.9	163.0	374,300
30	82.2	162.7	361,700
32	81.4	162.3	330,200
34	80.7	162.0	293,400
36	79.9	161.6	261,200
38	79.2	161.2	233,000
40	78.5	160.7	208,000
45	76.6	159.5	156,400
50	74.7	158.1	116,300
55	72.8	156.5	84,200
60	70.9	154.8	57,900
65	68.9	152.8	35,900
70	66.9	150.6	17,400

REFERENCE ONLY!