



Rectangular Swingaway Inspection Procedure

This program was designed to establish a standard field procedure to check and inspect booms for squareness, sweep, twist, camber, flatness or convex / concave conditions.

This procedure pertains to Grove and GMK built booms. Fabricated trapezoidal booms, formed trapezoidal booms, rectangular booms, rectangular swingaways, triangular swingaways and AFrame jibs.

This boom inspection data form will be used to record all measurements taken while performing the inspection.

Note: All calculations will be done by Manитowoc Product Support

Note: Anytime you are using the gauge blocks, record the thickness of the block used in the appropriate space on the form. Always use gauge blocks large enough to ensure the string does not touch the boom section. **All check dimensions recorded will include the gauge block thickness.**

Note: All measurements are taken from the rear of the section to the front, with the exception of checking for a twist in an A-Frame jib or a swingaway. You must check A-Frame jibs and swingaways by leveling the front of the section and taking the check dimension at the rear. Because of the angle of inclination of the main chords, the front end is narrower than the width at the rear of the section.

Tools Required

Quantity 1 - 4 Foot Level
Quantity 1 - Large Square (3' x 4')
Quantity 2 - Small Squares (24" x 16")
Quantity 2 - Vise Grip Clamps
Quantity 1 - 6" scale
Quantity 1 - 12 ' Tape Measure
Quantity 2 - Gauge Blocks or Rods (Same Thickness)
Mason String

Definitions

Trapezoidal Boom - A four sided boom with only 2 sides being parallel



Rectangular Boom - A four sided boom having edges, surfaces, or faces that are right angles



GMK Style / Megaform - A six sided boom made from two formed channels. The top half has 90° bends and the bottom half has multiple bends.



A-Frane Jib - A boom extension suspended by cables

Swingaway - A boom extension that is pinned directly to the main boom nose

Sweep - To curve to the right or left, a deviation from being parallel. Larger than the gauge block on one side and smaller than the gauge block on the other side.

Camber - To arch slightly, to curve upward or downward

Squareness - To test for a deviation from a right angle

Twist - To rotate while taking a curving path or direction

Convex - Arched up or bulging out condition

Concave - Arched inward or curving in condition

O. D. Width - Outside dimension measured from outside of left side plate to outside of right side plate

O. D. Height - Outside dimension measured from outside edge of top plate to outside edge of bottom plate

Distortion - To twist out of normal or original shape

Maximum Deviation - The difference between a fixed number (gauge block) and the check dimension

Check Dimension - The actual measurements taken at various places on boom

Strut - Tubing that is welded between main chords of A-Frame jibs

Gauge Blocks - Are blocks, being the same size, from which measurements are being taken

Main Chord - Main support tube that runs the full length of jibs and swingaways

Lacing - Tubing that is welded between the main chords of swingaways

Serial Number and Part Number Locations On Booms, Swingaways and Jib Booms

Machine component serial numbers and part numbers are required for us to supply repair procedures for major weldments.

Below a list of major components with serial number locations.

Note: Part number is on opposite side of the serial number.

The numbers are steel stamped into the major components in the approximate locations shown.

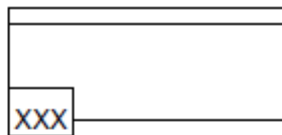

Fig. 1
Rectangular Boom
Left Forward
Bottom Corner

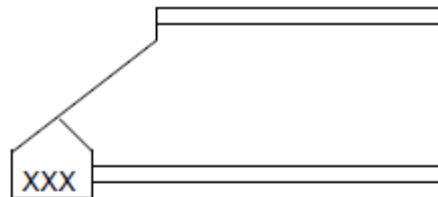

Fig. 2
Trapezoidal Boom
Bottom Left
Forward Bottom Corner

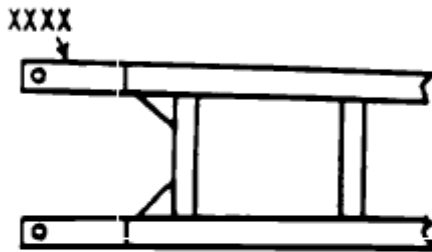

Fig. 3
A-Frame Jib

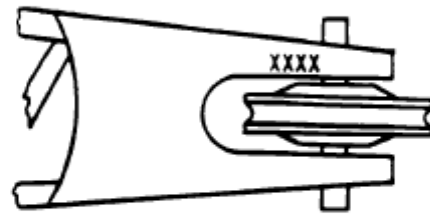

Fig. 4
Lattice Swingaways
and Fixed Lattice
Boom Extensions

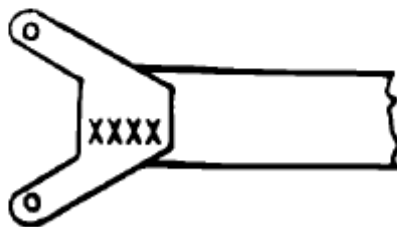

Fig. 6
Stevedore, IND 24, AP 308 and AP 206
Jib-Top Side of Trunnion Block

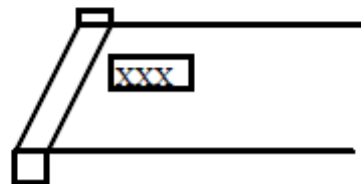
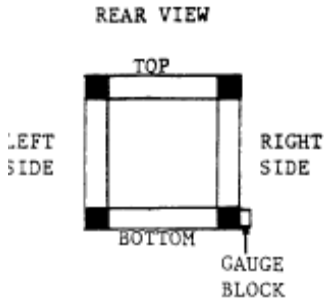

Fig. 5
GMK Style / Megaform

Rectangular Swingaway Sweep

Chkd. By _____ Model _____
 Date _____ Serial # _____
 Distributor _____
 Record Part Number of Swingaway _____
 Record Serial Number of Swingaway _____



1. Checking all lacing, one side at a time, place the gauge blocks on the lacing close to the main chord.
2. Pull the string tightly over the blocks.
3. Measure the distance between string and lacing at various points between gauge blocks.
4. Find maximum check dimensions and record on this form.
5. Repeat procedure for all sides.
6. Record thickness of gauge blocks.

Record Thickness Of Gauge Blocks _____

	<u>Right Side</u>	<u>Left Side</u>	<u>Top</u>	<u>Bottom</u>
a.	_____	_____	_____	_____
b.	_____	_____	_____	_____
c.	_____	_____	_____	_____
d.	_____	_____	_____	_____
e.	_____	_____	_____	_____
f.	_____	_____	_____	_____
g.	_____	_____	_____	_____
h.	_____	_____	_____	_____
i.	_____	_____	_____	_____
j.	_____	_____	_____	_____
k.	_____	_____	_____	_____
l.	_____	_____	_____	_____
m.	_____	_____	_____	_____
n.	_____	_____	_____	_____
o.	_____	_____	_____	_____
p.	_____	_____	_____	_____

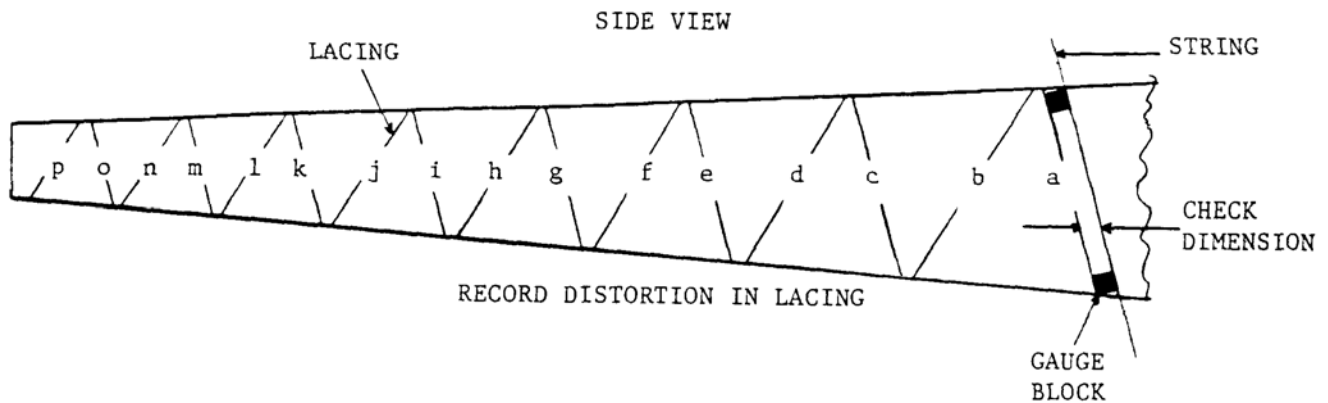

Rectangular Swingaway Distortion of Main Chords

Chkd. By _____ Model _____
 Date _____ Serial # _____
 Distributor _____
 Record Part Number of Swingaway _____
 Record Serial Number of Swingaway _____

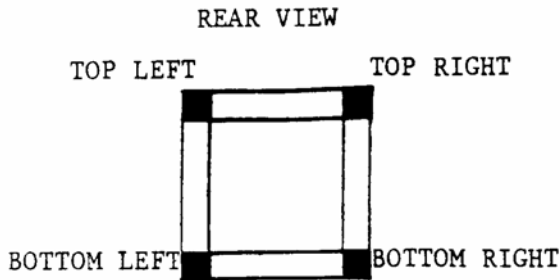

Record Thickness of Gauge Blocks _____

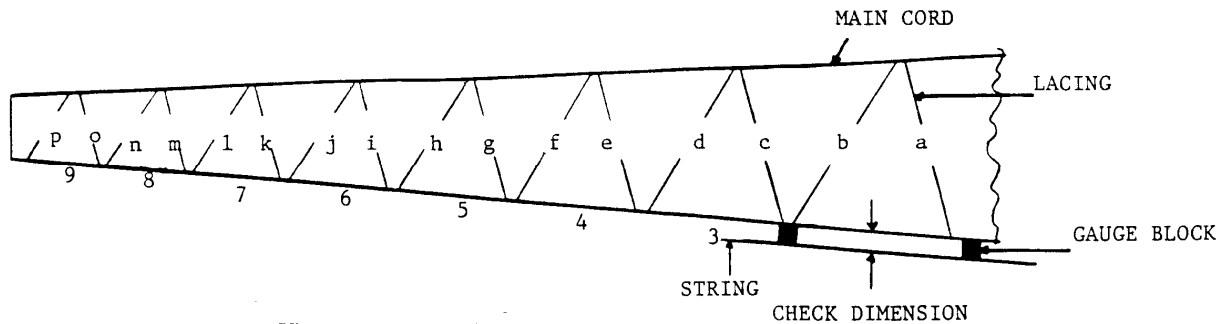

1. Place gauge blocks along outside of main chord where lacing is welded to main chord.
2. Pull string tightly across gauge blocks.
3. Measure distance between string and main chord at various points between blocks to find maximum check dimension.
4. Record check dimension on this form.
5. Repeat this procedure for all main chord sections between lacing on all 4 sides.
6. Record thickness of gauge blocks on this form.

Record Local Distortion of Main Chords

	Top R/side	Top L/side	Bottom R/side	Bottom L/side
1.	_____	_____	_____	_____
2.	_____	_____	_____	_____
3.	_____	_____	_____	_____
4.	_____	_____	_____	_____
5.	_____	_____	_____	_____
6.	_____	_____	_____	_____
7.	_____	_____	_____	_____
8.	_____	_____	_____	_____
9.	_____	_____	_____	_____

Rectangular Swingaway Twist

Chkd. By _____ Model _____
Date _____ Serial # _____
Distributor _____
Record Part Number of Swingaway _____
Record Serial Number of Swingaway _____

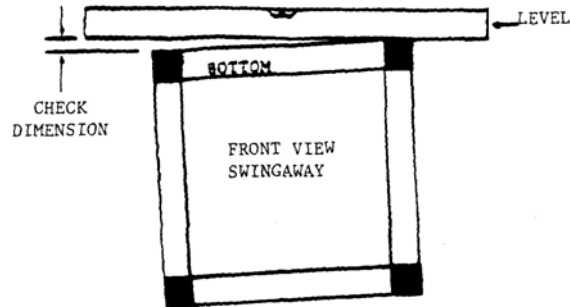

Record Check Dimension as Twist _____

1. Place the swingaway with the bottom up.
2. Place a 4' level across the bottom chords at the front of the swingaway.
3. Once the front is level, take the 4' level to the rear of the swingaway and place it across the bottom chords.
4. Lift either end of the level one way or the other until the bubble is level.
5. Measure the distance between the level and the bottom chord and record this check dimension as twist on this form.