



Grove RT880E

Product Guide

-  75 t
-  39 m
-  10,0 - 29,2 m
-  71 m



Rough Terrain Crane
Grúa para terrenos difíciles
Guindaste para terrenos acidentados

Features • Características • Características

Boom

The 39,0 m (128 ft) four-section full power MEGAFORM™ boom eliminates weight and increases capacity compared to conventional boom shapes.



Pluma

La pluma MEGAFORM™ de 39,0 m (128 pies) de cuatro secciones, completamente mecánica, elimina peso y aumenta la capacidad en comparación con las formas de pluma convencionales.

Lança

A lança MEGAFORM™ totalmente motorizada de quatro seções e 39,0 m (128 ft) elimina peso e aumenta a capacidade em comparação com os formatos convencionais de lança.



Removable counterweight

Counterweight and auxiliary hoist is hydraulically removed/installed for easier hauling from job to job.

Contrapeso desmontable

El contrapeso y el malacate auxiliar se retiran e instalan hidráulicamente para facilitar el transporte de un sitio a otro.

Contrapeso removível

O contrapeso e o guincho auxiliar são removidos/instalados hidráulicamente para facilitar o transporte de um local de serviço a outro.



Cab

For improved operator comfort and visibility of the boom load, the cab can be tilted up to 20°.

Cabina

Para mejor comodidad del operador y visibilidad de la carga de la pluma, la cabina puede inclinarse hasta 20°.

Cabine

Para maior conforto do operador e melhor visibilidade da carga da lança, a cabine pode ser inclinada até 20°.



Extensions

Maximum tip height of 70,6 m (232 ft) with 17,0 m (56 ft) bi-fold and two 6,1 m (20 ft) inserts.

Extensiones

Altura de punta máxima de 70,6 m (232 pies) con plegado doble de 17,0 m (56 pies) y dos insertos de 6,1 m (20 pies).

Extensões

Altura máxima da ponta de 70,6 m (232 ft) com extensão de duas seções de 17,0 m (56 ft) e dois insertos de 6,1 m (20 ft).

CraneSTAR

CraneSTAR is an exclusive and innovative crane asset management system that helps improve your profitability and reduce costs by remotely monitoring critical crane data. Visit www.cranestar.com for more information.

CraneSTAR es un exclusivo e innovador sistema de gestión de flotas de grúas que ayuda a mejorar su rentabilidad y reducir los costos al permitir monitorear a distancia los datos críticos de las grúas. Visite el sitio Web www.cranestar.com para más información.

CraneSTAR é um sistema de gerenciamento de ativos de guindastes exclusivo e inovador que ajuda a melhorar sua lucratividade e reduzir custos por meio do monitoramento remoto de dados críticos do guindaste. Acesse www.cranestar.com para obter mais informações.

Specifications	4
Especificaciones	6
Especificações	8
Data • Datos • Dados	10
Dimensions • Dimensiones • Dimensões	11
Weight reductions • Reducciones de peso • Reduções de peso	12
Working range • Alcance de trabajo • Faixa de trabalho	13
Load charts • Tablas de carga • Tabelas de carga	14
Symbols glossary • Glosario de símbolos • Glossário de símbolos	20

Specifications

Superstructure

Boom

12,6 m – 39,0 m, four-section, sequenced synchronized full power boom.

Maximum tip height: 41,9 m.

*Bifold swingaway extension

10,0 m - 17,1 m offsettable bifold lattice swingaway extension. Offsets 0°, 20° and 40°. Stows alongside base boom section.

Maximum tip height: 58,6 m.

*Boom extension inserts

2 x 6,1 m lattice extension inserts. Installs between the boom nose and bifold extension, non-stowable. Maximum tip height: 70,6 m.

Boom elevation

One double acting hydraulic cylinder with integral holding valve provides elevation from -3° to +78°.

Load moment and anti-two block system

Standard “Graphic Display” load moment and anti-two block system with audio-visual warning and control lever lockout. These systems provide electronic display of boom angle, length, radius, tip height, relative load moment, maximum permissible load, load indication and warning of impending two-block condition. The standard Work Area Definition System allows the operator to pre-select and define safe working areas. If the crane approaches the pre-set limits, audio-visual warnings aid the operator in avoiding job-site obstructions.

Cab

20° tilt, Full-vision, all-steel fabricated with acoustical lining and tinted safety glass throughout. Deluxe seat incorporates single-axis hydraulic controllers. Tilt/telescoping steering wheel with various controls incorporated into the steering column. Other standard features include: hot water heater, cab circulating air fan, sliding side and rear windows, sliding skylight with electric wiper and sunscreen, electric windshield wash/wipe, fire extinguisher, seat belt, air conditioning, and dual cab mounted work light.

Slewing

Two speed, planetary swing drive with foot applied multi-disc wet brake. Spring applied, hydraulically released swing brake. Single position mechanical house lock, operated from cab. Maximum speed: 2,0 RPM.

Counterweight

8 165 kg. Hydraulically installed and removed.

Hoist

Planetary reduction with automatic spring applied multi-disc wet brake. Electronic hoist drum rotation indicators, and hoist drum cable followers.

Maximum Single Line Pull:

1st layer: 9 185 kg

3rd layer: 7 716 kg

5th layer: 6 650 kg

Maximum Permissible Line Pull:

7 620 kg with 6X37 class rope.

7 620 kg. with 35X7 Rotation Resistant rope.

Maximum Single Line Speed: 156 m/min

Rope Construction: 6X36 EIPS IWRC, Special Flexible
35x7 Rotation Resistant

Rope Diameter: 19mm

Rope Length: Main Hoist: 183 m - Auxiliary Hoist: 183 m

Maximum Rope Stowage: 256 m

Carrier



Carrier frame

Box section frame fabricated from high-strength, low alloy steel. Front/rear towing, lift and tie down lugs.



Outriggers

Four hydraulic telescoping single-stage double box beam outriggers with inverted jacks and integral holding valves. Three position setting, 0%, 50% and fully extended. All steel fabricated, quick release type outrigger floats, 775 mm diameter. Maximum outrigger pad load: 56 700 kg. Controls and crane level indicator located in cab.



Hydraulic system

Two main pumps ([1] piston and [1] gear) with a combined capacity of 503 LPM.

Maximum operating pressure: 277,7 bar. Three section pressure compensated valve bank. Return line type filter with full flow bypass protection and service indicator.

Replaceable cartridge with micron filtration rating of 5/12/16. 959 L hyd. reservoir. Carrier mounted oil cooler with thermostatically controlled hydraulic motor driven fan/air to oil. System pressure test ports.



Engine

Cummins QSB 6.7L diesel, six cylinders, 205 kW (275 bhp) (Gross) at 2500 rpm.

Maximum torque: 987 Nm (728 ft lb) at 1500 rpm.

Note: Required for sale outside of North American and European Union countries.



Transmission

Sequential powershift with 6 forward and 6 reverse speeds. Front axle disconnect for 4 x 2 travel.



Drive/Steer

4 x 4.

Fully independent power steering:

Front: Full hydraulic steering wheel controlled.

Rear: Full hydraulic switch controlled.

Provides infinite variations of 4 main steering modes: front only, rear only, crab and coordinated. Rear steer indicator. Outside turning radius: 7,3 m.



Axles

Front: Drive/steer with differential and planetary reduction hubs rigid mounted to frame.

Rear: Drive/steer with differential and planetary reduction hubs pivot mounted to frame.



Tyres

29,5 x 25 - 34 bias ply.



Lights

Full lighting including turn indicators, head, tail, brake and hazard warning lights.



Maximum speed

35 km/h.



Brakes

Full hydraulic split circuit operating on all wheels. Spring-applied, hydraulically released parking brake mounted on front axle.



Gradeability (theoretical)

75% based on 49 588 kg GVW, 29,5 x 25 tyres, 39,0 m boom, plus 17,1 m swingaway, 8165 kg counterweight, 75 t hookblock and 9 t headache ball.



Electrical system

Two 12 V - maintenance free batteries. 12 V starting and lighting. Battery disconnect. CanBus Diagnostic system.

*Optional equipment

- CE Mark conformance
- Auxiliary lighting package: Includes turntable mounted amber flashing light, dual base boom mounted floodlights and Rubber mat for storage trough.
- LMI light bar (in cab)
- 360° NYC style mechanical swing lock
- Rear Pintle hook
- Cab controlled cross axle differential locks, (front and rear)
- PAT event recorder

Especificaciones

Superestructura



Pluma

Pluma mecánica de cuatro secciones de secuencia sincronizada, de 12,6 a 39,0 m.

Altura máxima a la punta: 41,9 m.



*Extensión articulada de plegado doble

Extensión articulada de celosía de plegado doble descentrable, de 10,0 m a 17,1 m. Se descentra 0°, 20° y 40°. Se almacena al lado de la sección de base de la pluma.

Altura máxima de la punta: 58,6 m.



*Insertos de extensión de la pluma

Insertos de extensión de celosía de 2 x 6,1 m. Se instala entre la punta de la pluma y la extensión de plegado doble, no se almacena.

Altura máxima de la punta: 70,6 m.



Elevación de pluma

Un cilindro hidráulico de doble acción con válvula de retención incorporada proporciona elevación de -3° a +78°.



Momento de carga y sistema de prevención del contacto entre bloques

Momento de carga con "pantalla gráfica" estándar y sistema de prevención del contacto entre bloques con advertencia sonora y visual y bloqueo de palancas de control. Estos sistemas proporcionan un desplegado electrónico del ángulo de la pluma, largo, radio, altura a la punta, momento de carga relativo, carga máxima admisible, indicación de carga y advertencia de la condición inminente del contacto entre bloques. El sistema de definición de la zona de trabajo estándar permite al operador preseleccionar y definir zonas de trabajo seguras. Si la grúa se aproxima a los límites preestablecidos, unas señales de advertencia sonoras y visuales ayudan al operador a evitar las obstrucciones en la obra.



Cabina

Inclinación hasta 20°, vista panorámica, fabricada enteramente de acero con forro acústico y cristal inastillable oscurecido. El asiento de lujo incorpora palancas de control hidráulicas de eje único. Volante de dirección inclinable/telescópico con diversos controles incorporados en la columna de dirección. Otras características estándar incluyen: calentador de agua, ventilador de circulación de aire de la cabina, ventanas de corredera laterales y trasera, luna de corredera con limpiacristal y visera eléctricos, lava/limpiaparabrisas eléctrico, extintor de incendios, cinturón de seguridad, acondicionador de aire y luces de trabajo dobles montadas en la cabina.



Inclinación

Mando de giro planetario de dos velocidades con freno de discos múltiples en baño de aceite accionado por pedal. Freno de giro aplicado por resorte, liberado hidráulicamente. Bloqueo mecánico de caja de una sola posición, accionado desde la cabina. Velocidad máxima: 2,0 rpm.



Contrapeso

8165 kg, instalado y retirado hidráulicamente.



Malacate

Reducción planetaria con freno automático de discos múltiples en baño de aceite aplicado por resorte. Indicadores electrónicos de rotación del tambor de malacate, y seguidores de cable del tambor de malacate.

Tracción máxima de cable sencillo:

1a capa: 9185 kg

3a capa: 7716 kg

5a capa: 6650 kg

Tracción máxima admisible del cable:

7620 kg con cable de clase 6x37.

7620 kg con cable de 35x7 resistente a la rotación.

Velocidad máxima de cable sencillo: 156 m/min.

Construcción del cable: 6x36 EIPS IWRC, flexible especial
35x7 resistente a la rotación

Diámetro del cable: 19 mm

Longitud del cable: Malacate principal: 183 m
Malacate auxiliar: 183 m

Almacenamiento máximo de cable en tambor: 256 m

Vehículo



Bastidor de vehículo

Bastidor en forma de cajón fabricado de acero de baja aleación y alta resistencia.
Orejetas delantera/trasera de remolcado, elevación y amarre.



Estabilizadores

Cuatro estabilizadores hidráulicos telescópicos con vigas de una etapa con gatos invertidos y válvulas de retención integradas.
Tres ajustes de posición, 0%, 50% y completamente extendidos.
Bases de estabilizadores de desconexión rápida fabricadas en acero, 775 mm de diámetro.
Carga máxima de base de estabilizador: 56 700 kg.
Controles e indicador de nivel de la grúa ubicados en la cabina.



Sistema hidráulico

Dos bombas principales ([1] de émbolo y [1] de engranajes) con una capacidad combinada de 503 l/min.
Presión máxima de funcionamiento: 277,7 bar. Banco de válvulas de presión compensada de tres secciones. Filtro en la línea de retorno con protección de derivación de caudal pleno e indicador de servicio.
Cartucho reemplazable con clasificación de filtrado micrométrico de 5/12/16.
Depósito hidráulico de 959 l. Enfriador de aceite montado en el vehículo con ventilador/aire a aceite accionado por motor hidráulico controlado termostáticamente.
Lumbreras de prueba de presión del sistema.



Motor

Motor diesel Cummins QSB de 6,7 litros, seis cilindros, 205 kW (275 bhp) (bruto) a 2500 rpm.
Par motor máximo: 987 Nm (728 lb-pie) a 1500 rpm.
Nota: Requerido para venta fuera de Norteamérica y países de la Unión Europea.



Transmisión

Servotransmisión secuencial con 6 marchas de avance y 6 de retroceso.
Desconexión de eje delantero para tracción 4 x 2.



Tracción/dirección

4 x 4.
Dirección hidráulica completamente independiente:
Delantero: Completamente hidráulica controlada por volante de dirección.
Trasero: Completamente hidráulica controlada por interruptor.
Ofrece variaciones infinitas de 4 modos de dirección principal: delantera solamente, trasera solamente, cangrejo y coordinada.
Indicador de dirección trasera. Radio de giro exterior: 7,3 m.



Ejes

Delantero: Tracción/dirección con diferencial y cubos de reducción planetaria rígidos montados en el bastidor.
Trasero: Tracción/dirección con diferencial y cubos de reducción planetaria pivotantes montados en el bastidor.



Neumáticos

29.5 x 25 - 34 telas diagonales.



Luces

Iluminación completa incluyendo señalizadores de viraje, faros, luces de cola, frenos y luces de advertencia.



Velocidad máxima

35 km/h



Frenos

Circuito dividido completamente hidráulico funcionando en todas las ruedas. Freno de estacionamiento montado en el eje delantero, aplicado por resorte y liberado hidráulicamente.



Capacidad de pendiente (teórica)

75% basada en peso bruto del vehículo de 49 588 kg, neumáticos de 29.5 x 25, pluma de 39,0 m, más extensión articulada de 17,1 m, contrapeso de 8165 kg, aparejo de gancho de 75 t y bola de gancho de 9 t.



Sistema eléctrico

Dos baterías de 12 V exentas de mantenimiento. Arranque e iluminación de 12 V.
Desconexión de baterías. Sistema de diagnóstico de bus CAN.

*Equipo opcional

- Conformidad con la marca CE
- Paquete de alumbrado auxiliar: Incluye una luz destellante ámbar montada en la plataforma de giro, proyectores de base doble montados en la pluma y cubierta de caucho para la cubeta de almacenamiento.
- Barra de luces de LMI (en la cabina)
- Bloqueo de giro mecánico estilo NYC de 360°
- Gancho de clavija trasero
- Bloqueos de diferencial entre ruedas controlados desde la cabina (delantero y trasero)
- Registrador de eventos PAT

Especificações

Superestrutura

Lança

Lança sequencial sincronizada totalmente motorizada de quatro seções e 12,6 m a 39,0 m.

Altura máxima da ponta: 41,9 m.

*Extensão articulada de duas seções

Extensão articulada treliçada de duas seções deslocáveis, de 10,0 m a 17,1 m. Desloca-se 0°, 20° e 40°. Retrai ao longo da seção da base da lança.

Altura máxima da ponta: 58,6 m.

*Insertos de extensão da lança

2 insertos de extensão treliçados de 6,1 m. Se instalam entre a extremidade da lança e a extensão de duas seções, não recolhíveis. Altura máxima da ponta: 70,6 m.

Elevação da lança

Um cilindro hidráulico de dupla ação com válvula de retenção integral proporciona elevação de -3° a +78°.

Sistema de momento de carga e anticolisão do moitão

Sistema de momento de carga e anticolisão do moitão com “Mostrador gráfico” com advertência audiovisual e bloqueio da alavanca de controle. Esses sistemas oferecem exibição eletrônica do ângulo da lança, comprimento, raio, altura da ponta, momento de carga relativo, indicação de carga e advertência de condição de colisão iminente do moitão. O Sistema de definição da área de trabalho padrão permite que o operador selecione e defina previamente as áreas de trabalho seguras. Se o guindaste se aproxima dos limites predefinidos, advertências audiovisuais ajudam o operador a evitar obstruções no local de trabalho.

Cabine

Inclinação de 20°, visão total, fabricada totalmente em aço, com revestimento acústico e inteiramente com vidros de segurança escuros. O assento Deluxe incorpora controladores hidráulicos de eixo único. Volante com ajuste de inclinação/telescópico com vários controles incorporados à coluna de direção. Outros recursos incluem: aquecedor de água quente, ventilador de circulação de ar da cabine, janelas laterais e traseiras deslizantes, teto solar deslizante com limpador elétrico e proteção contra o sol, limpador/lavador elétrico do para-brisa, extintor de incêndio, cinto de segurança, ar-condicionado e luzes de trabalho duplas montadas na cabine.

Giro

Acionamento de giro planetário de duas velocidades, com freio úmido multidisco aplicado por pedal. Freio de giro aplicado por mola e liberado hidráulicamente. Trava mecânica da estrutura de giro de posição única, operada da cabine. Velocidade máxima: 2,0 rpm.

Contrapeso

8165 kg. Instalado e removido hidráulicamente.

Guincho

Redução planetária com freio úmido multidisco aplicado automaticamente por mola. Indicadores eletrônicos de rotação do tambor do guincho e seguidores do cabo do tambor do guincho.

Tração máxima de cabo único:

1ª camada: 9185 kg

3ª camada: 7716 kg

5ª camada: 6650 kg

Tração máxima permitida do cabo:

7620 kg com cabo classe 6X37.

7620 kg com cabo 35X7 resistente à rotação.

Velocidade máxima de cabo único: 156 m/min.

Estrutura do cabo: 6X36 EIPS IWRC, flexível especial 35x7 resistente à rotação

Diâmetro do cabo: 19 mm

Comprimento do cabo: Guincho principal: 183 m

Guincho auxiliar: 183 m

Recolhimento máximo de cabo: 256 m

Transportador



Estrutura do transportador

Estrutura da seção da caixa fabricada em aço de liga leve de alta resistência. Olhais de reboque dianteiro/traseiro, de elevação e de fixação.



Estabilizadores

Quatro estabilizadores hidráulicos telescópicos de estágio único e vigas de caixa dupla com macacos invertidos e válvulas de retenção integradas. Ajuste de três posições, 0%, 50% e totalmente estendidos. Flutuadores dos estabilizadores do tipo liberação rápida, fabricados totalmente em aço, com 775 mm de diâmetro. Carga máxima na patola do estabilizador: 56 700 kg. Controles e indicador de nível do guindaste localizados na cabine.



Sistema hidráulico

Duas bombas principais (1 de pistão e 1 de engrenagem) com capacidade combinada de 503 l/min.

Pressão máxima de operação: 277,7 bar. Banco de válvulas de três seções com compensação de pressão. Filtro tipo linha de retorno com proteção de contorno de vazão total e indicador de manutenção.

Cartucho substituível com taxa de filtração de 5/12/16 microns. Reservatório hidráulico de 959 l. Resfriador de óleo montado no transportador com ventilador/ar para óleo acionado por motor hidráulico controlado termostaticamente. Entradas de teste de pressão do sistema.



Motor

Cummins QSB 6,7 l a diesel, seis cilindros, 205 kW (275 bhp) (Bruto) a 2500 rpm.

Torque máximo: 987 Nm (728 lb-ft) a 1500 rpm.

Nota: Necessário para venda fora dos países da América do Norte e União Europeia.



Transmissão

Powershift sequencial com 6 velocidades de avanço e 6 de ré. Desconexão do eixo dianteiro para deslocamento 4 x 2.



Tração/direção

4 x 4

Direção hidráulica totalmente independente:

Dianteira: totalmente hidráulica controlada pelo volante de direção.

Traseira: totalmente hidráulica controlada por interruptor.

Oferece variações infinitas dos 4 modos de direção principais: somente dianteira, somente traseira, caranguejo e coordenada. Indicador de direção traseira. Raio de curva externo: 7,3 m.



Eixos

Dianteira: tração/direção com diferencial e cubos de redução planetária de montagem rígida na estrutura.

Traseira: tração/direção com diferencial e cubos de redução planetária de montagem articulada na estrutura.



Pneus

29.5 x 25 - 34 lonas oblíquas.



Luzes

Iluminação completa incluindo indicadores direcionais, faróis, lanternas traseiras luzes de freio e de atenção de perigo.



Velocidade máxima

35 km/h



Freios

Circuito totalmente hidráulico dividido operando em todas as rodas. Freio de estacionamento aplicado por mola e liberado hidraulicamente montado no eixo dianteiro.



Capacidade de subida de rampa (teórica)

75% baseada em 49 588 kg GVW, pneus de 29.5 x 25, lança de 39,0 m, mais extensão articulada de 17,1 m, contrapeso de 8165 kg, moitão de gancho de 75 t e bola do guindaste de 9 t.



Sistema elétrico

Duas baterias de 12 V livres de manutenção. Partida e iluminação de 12 V.

Desconexão da bateria. Sistema de diagnóstico por barramento CAN.

*Equipamento opcional

- Marca de conformidade CE
- Pacote de luzes auxiliares: inclui luz intermitente âmbar montada na plataforma rotativa, holofotes de base dupla montados na lança e tapete de borracha para o compartimento de armazenamento.
- Barra de luzes do IMC (na cabine)
- Trava de giro mecânica tipo NYC de 360°.
- Gancho de engate traseiro
- Bloqueios transversais do diferencial controlados na cabine, (dianteiro e traseiro)
- Registrador de eventos PAT

Data • Datos • Dados



Axle • Eje • Eixo	1	2	Total weight • Peso total • Peso total
	t	t	
Basic machine • Máquina básica • Máquina básica	24,5	24,9	49,5
Remove counterweight and aux. Hoist Retire el contrapeso y malacate auxiliar Removendo o contrapeso e o guincho auxiliar	28,9	11,3	40,3
Remove counterweight, aux. Hoist and bifold swingaway Retire el contrapeso, malacate auxiliar y sección articulada de plegado doble Removendo contrapeso, guincho auxiliar e extensão articulada de duas seções	26,7	12,3	39,1



Lifting Capacity • Capacidad de elevación • Capacidade de elevação	Sheaves • Poleas • Polias	Parts of line • Secciones de cable • Pernas de cabo	Total weight • Peso total • Peso total
75 t	5	10	598 kg
9 t	H/B (swivel)	1	257 kg



	Infinitely variable • Infinitamente variable • Infinitamente variável	Rope • Cable • Cabo	Permissible line pull max. • Tracción de cable máx. • admisible • Tração máx. permissível do cabo	Nominal cable length • Largo nominal de cable • Comprimento nominal do cabo
	0 - 156 m/min single line • cable sencillo • cabo único	19 mm (6x36 class)	7620 kg	183 m
	0 - 156 m/min single line • cable sencillo • cabo único	19 mm (non-rotational)	7620 kg	183 m
	0 - 2,0 min ⁻¹			
	-3° to + 78° approx. 55 s • aprox. 55 s • aprox. 55 s			
	12,9 to 39,0 m approx. 115 s • aprox. 115 s • aprox. 115 s			

Dimensions • Dimensiones • Dimensões

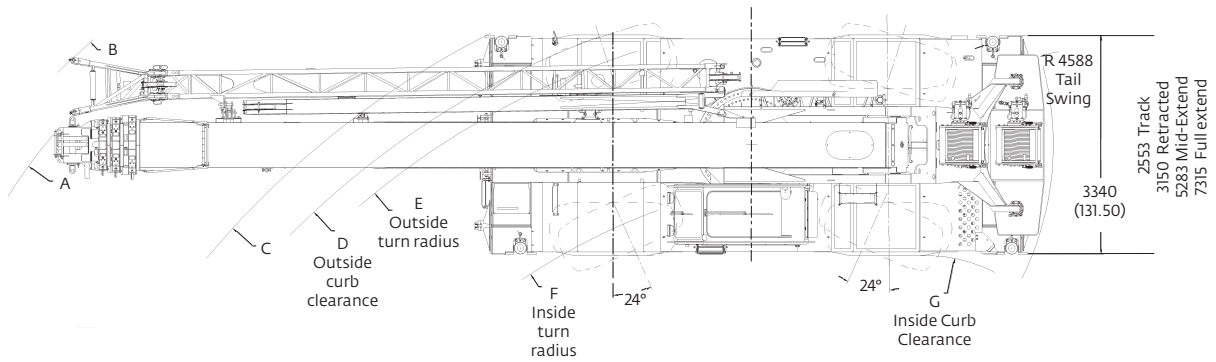

Note: Reference dimensions in mm •
 Nota: Dimensiones de referencia en mm •
 Nota: Consulte as dimensões em mm

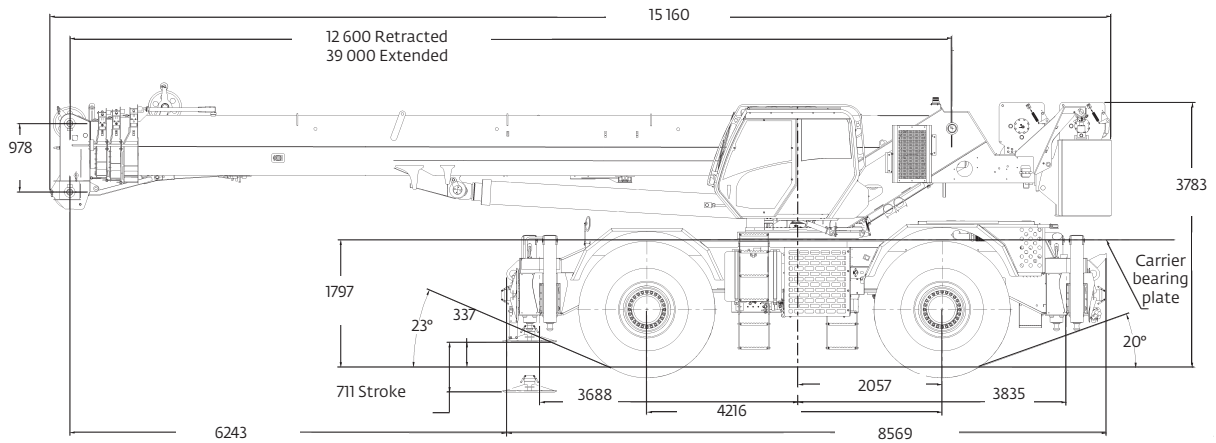

Tire size	A	B	C	D	E	F	G	A	B	C	D	E	F	G
29,5-25	16,6 m	17,2 m	13,6 m	12,9 m	12,5 m	12,5 m	8,8 m	11,1 m	11,6 m	8,4 m	7,8 m	7,3 m	4,9 m	4,1 m
	2 wheel steer							4 wheel steer						

Weight reductions • Reducciones de peso • Reduções de peso

Weight reductions • Reducciones de peso • Reduções de peso

Auxiliary boom nose / Punta de pluma auxiliar / Extremidade da lança auxiliar	62 kg
Hookblocks / Aparejos de gancho / Moitões de gancho	
75 tonne 5 sheave / 75 t, 5 poleas / 75 t, 5 polias	598 kg
36 tonne 3 sheave / 36 t, 3 poleas / 36 t, 3 polias	545 kg
9,1 tonne overhaul ball / Bola del gancho, 9,1 t / Bola do guindaste de 9,1 t	258 kg
10-17 m bifold swingaway fly jib / Plumín articulado de plegado doble de 10 a 17 m / Jib da extensão articulada de duas seções de 10 a 17 m	
10 m erected / 10 m elevado / 10 m montado	1678 kg
17 m erected / 17 m elevado / 17 m montado	3552 kg
23,1 m jib erected / Plumín de 23,1 m elevado / Jib de 23,1 m montado	4695 kg
29,2 m jib erected / Plumín de 29,2 m elevado / Jib de 29,2 m montado	6033 kg



Note: All load handling devices and boom attachments are considered part of the load and suitable allowances must be made for their combined weights.

Nota: Todos los dispositivos de manejo de cargas y los accesorios de la pluma se consideran parte de la carga y deberán calcularse márgenes adecuados para sus pesos combinados.

Nota: Todos os dispositivos de movimentação de carga e acessórios da lança são considerados parte da carga, e seus pesos combinados devem ser considerados nos cálculos.

Working range • Alcance de trabajo • Faixa de trabalho



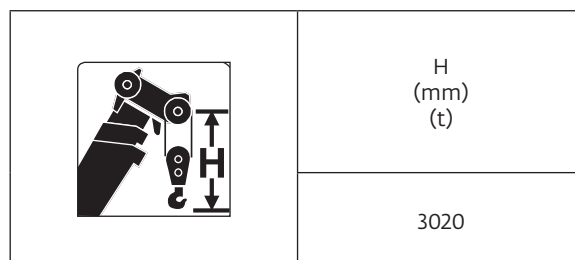
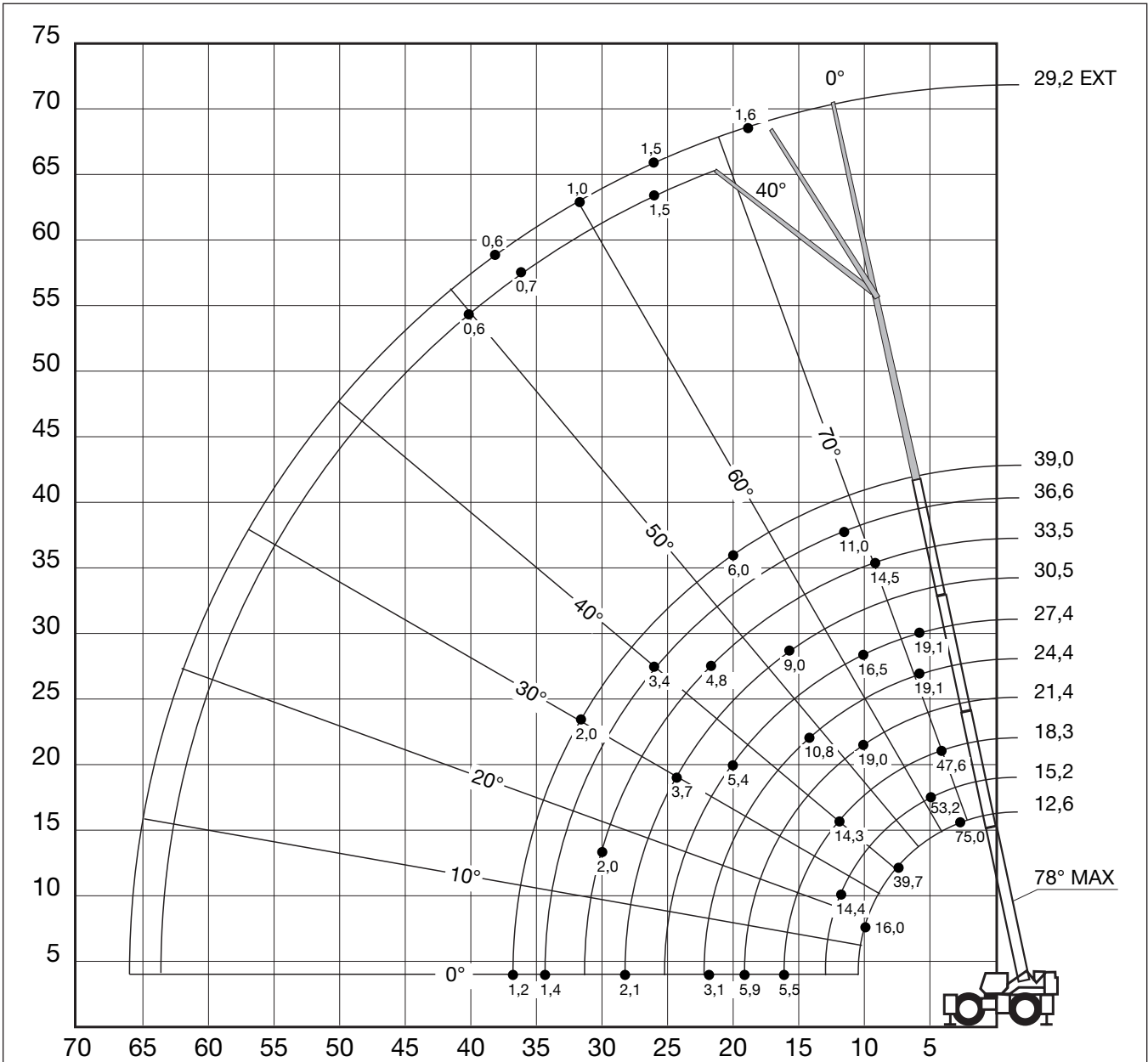

Working range • Alcance de trabajo • Faixa de trabalho

 12,6 – 39,0 m
  100%
  360°
  8,2 t



Load charts • Tablas de carga • Tabelas de carga

Telescopic boom • Pluma telescópica • Lança telescópica

 12,6 – 39,0 m
  100%
  360°
  8,2 t



DIN/ISO

m	12,6	15,2	18,3	21,4	24,4	27,4	30,5	33,5	36,6	39,0	m
3,0	75,000	56,225	47,850	-	-	-	-	-	-	-	3,0
3,5	68,025	56,225	47,850	-	-	-	-	-	-	-	3,5
4,0	64,625	56,225	47,575	26,975	-	-	-	-	-	-	4,0
4,5	59,675	56,225	47,225	26,975	19,075	-	-	-	-	-	4,5
5,0	55,125	53,150	44,850	26,975	19,075	19,050	-	-	-	-	5,0
6,0	46,075	45,975	39,475	26,975	19,075	19,050	17,975	-	-	-	6,0
7,0	39,750	38,600	35,350	26,325	19,075	19,050	17,975	14,475	-	-	7,0
8,0	32,775	30,925	28,800	25,000	19,075	18,700	17,575	14,475	11,675	9,975	8,0
9,0	25,650	25,200	23,850	22,450	19,075	17,825	16,525	14,475	11,675	9,975	9,0
10,0	15,975	20,475	20,200	19,000	18,075	16,450	15,150	13,800	11,675	9,975	10,0
12,0	-	14,375	14,275	14,050	14,225	13,825	12,650	11,800	10,925	9,975	12,0
14,0	-	-	10,500	10,300	10,825	11,150	10,825	10,075	9,530	9,170	14,0
16,0	-	-	5,500	7,725	8,335	8,675	9,020	8,720	8,210	7,880	16,0
18,0	-	-	-	5,855	6,480	6,835	7,145	7,340	7,145	6,830	18,0
20,0	-	-	-	-	5,080	5,415	5,730	5,930	6,125	5,985	20,0
22,0	-	-	-	-	3,125	4,300	4,610	4,825	5,020	5,160	22,0
24,0	-	-	-	-	-	3,405	3,695	3,925	4,135	4,275	24,0
26,0	-	-	-	-	-	-	2,950	3,180	3,400	3,550	26,0
28,0	-	-	-	-	-	-	2,120	2,555	2,775	2,930	28,0
30,0	-	-	-	-	-	-	-	2,025	2,245	2,405	30,0
32,0	-	-	-	-	-	-	-	-	1,790	1,950	32,0
34,0	-	-	-	-	-	-	-	-	1,395	1,555	34,0
36,0	-	-	-	-	-	-	-	-	-	1,210	36,0

80005124



85%

m	12,6	15,2	18,3	21,4	24,4	27,4	30,5	33,5	36,6	39,0	m
3,0	75,000	56,225	47,850	-	-	-	-	-	-	-	3,0
3,5	68,025	56,225	47,850	-	-	-	-	-	-	-	3,5
4,0	64,625	56,225	47,575	26,975	-	-	-	-	-	-	4,0
4,5	59,675	56,225	47,225	26,975	19,075	-	-	-	-	-	4,5
5,0	55,125	53,150	44,850	26,975	19,075	19,050	-	-	-	-	5,0
6,0	46,075	45,975	39,475	26,975	19,075	19,050	17,975	-	-	-	6,0
7,0	39,750	39,625	35,350	26,325	19,075	19,050	17,975	14,475	-	-	7,0
8,0	34,800	34,450	31,750	25,000	19,075	18,700	17,575	14,475	11,675	9,975	8,0
9,0	27,650	27,200	27,075	22,675	19,075	17,825	16,525	14,475	11,675	9,975	9,0
10,0	15,975	22,200	22,075	20,675	18,075	16,450	15,150	13,800	11,675	9,975	10,0
12,0	-	15,700	15,625	15,400	15,550	13,825	12,650	11,800	10,925	9,975	12,0
14,0	-	-	11,600	11,425	11,950	11,875	10,825	10,075	9,530	9,170	14,0
16,0	-	-	5,500	8,675	9,295	9,635	9,425	8,720	8,210	7,880	16,0
18,0	-	-	-	6,690	7,325	7,680	7,990	7,610	7,145	6,830	18,0
20,0	-	-	-	-	5,835	6,170	6,485	6,680	6,275	5,985	20,0
22,0	-	-	-	-	3,125	4,985	5,295	5,510	5,540	5,290	22,0
24,0	-	-	-	-	-	4,035	4,325	4,550	4,760	4,690	24,0
26,0	-	-	-	-	-	-	3,530	3,760	3,980	4,130	26,0
28,0	-	-	-	-	-	-	2,120	3,095	3,315	3,475	28,0
30,0	-	-	-	-	-	-	-	2,530	2,755	2,915	30,0
32,0	-	-	-	-	-	-	-	-	2,270	2,430	32,0
34,0	-	-	-	-	-	-	-	-	1,395	2,015	34,0
36,0	-	-	-	-	-	-	-	-	-	1,645	36,0

80005129

Load charts • Tablas de carga • Tabelas de carga

Telescopic boom • Pluma telescópica • Lança telescópica

 12,6 – 39,0 m
  50%
  360°
  8,2 t



DIN/ISO - 85%

m	12,6	15,2	18,3	21,4	24,4	27,4	30,5	33,5	36,6	39,0	m
3,0	67,350	56,225	47,850	-	-	-	-	-	-	-	3,0
3,5	59,950	56,225	47,850	-	-	-	-	-	-	-	3,5
4,0	53,375	52,675	47,325	26,975	-	-	-	-	-	-	4,0
4,5	47,450	44,850	40,850	26,975	19,075	-	-	-	-	-	4,5
5,0	41,425	38,075	34,925	26,975	19,075	19,050	-	-	-	-	5,0
6,0	31,000	28,850	26,700	24,850	19,075	19,050	17,975	-	-	-	6,0
7,0	24,400	22,825	21,275	19,900	19,075	19,050	17,975	14,475	-	-	7,0
8,0	19,475	18,600	17,425	16,325	16,175	15,950	15,675	14,475	11,675	9,975	8,0
9,0	15,525	15,225	14,500	13,650	13,625	13,525	13,375	13,175	11,675	9,975	9,0
10,0	12,625	12,475	12,225	11,525	11,625	11,600	11,525	11,400	11,250	9,975	10,0
12,0	-	8,710	8,625	8,410	8,645	8,760	8,785	8,770	8,715	8,665	12,0
14,0	-	-	6,155	6,005	6,530	6,720	6,840	6,880	6,880	6,875	14,0
16,0	-	-	4,420	4,250	4,820	5,190	5,355	5,460	5,500	5,525	16,0
18,0	-	-	-	2,950	3,545	3,885	4,200	4,335	4,415	4,470	18,0
20,0	-	-	-	-	2,560	2,880	3,190	3,405	3,530	3,605	20,0
22,0	-	-	-	-	1,780	2,085	2,375	2,595	2,800	2,885	22,0
24,0	-	-	-	-	-	1,435	1,715	1,935	2,145	2,290	24,0
26,0	-	-	-	-	-	-	1,170	1,390	1,600	1,750	26,0
28,0	-	-	-	-	-	-	0,710	0,930	1,145	1,295	28,0
30,0	-	-	-	-	-	-	-	0,540	0,750	0,905	30,0
32,0	-	-	-	-	-	-	-	-	-	0,570	32,0

AC-829-103677

 12,6 – 39,0 m
  0%
  360°
  8,2 t



DIN/ISO - 85%

m	12,6	15,2	18,3	21,4	24,4	27,4	30,5	33,5	36,6	39,0	m
3,0	39,875	36,000	32,400	-	-	-	-	-	-	-	3,0
3,5	32,500	29,675	26,950	-	-	-	-	-	-	-	3,5
4,0	27,175	25,050	22,875	21,025	-	-	-	-	-	-	4,0
4,5	23,150	21,450	19,725	18,175	17,675	-	-	-	-	-	4,5
5,0	20,000	18,600	17,200	15,900	15,550	15,150	-	-	-	-	5,0
6,0	15,425	14,375	13,350	12,425	12,300	12,125	11,875	-	-	-	6,0
7,0	12,275	11,400	10,600	9,900	9,955	9,885	9,775	9,630	-	-	7,0
8,0	9,955	9,220	8,545	7,955	8,130	8,170	8,140	8,065	7,960	7,870	8,0
9,0	7,870	7,525	6,940	6,440	6,670	6,795	6,835	6,815	6,760	6,710	9,0
10,0	6,235	6,110	5,660	5,220	5,495	5,660	5,765	5,795	5,770	5,750	10,0
12,0	-	3,940	3,750	3,385	3,710	3,930	4,090	4,190	4,245	4,265	12,0
14,0	-	-	2,365	2,070	2,425	2,675	2,865	3,000	3,085	3,145	14,0
16,0	-	-	1,275	1,090	1,455	1,725	1,935	2,090	2,195	2,270	16,0
18,0	-	-	-	-	0,705	0,980	1,200	1,370	1,490	1,575	18,0
20,0	-	-	-	-	-	-	0,615	0,790	0,920	1,010	20,0
22,0	-	-	-	-	-	-	-	-	-	0,545	22,0

AC-829-103678

Load charts • Tablas de carga • Tabelas de carga

Telescopic boom • Pluma telescópica • Lança telescópica



12,6 – 39,0 m



0 km/h



360°



8,2 t



DIN/ISO

m	12,6	15,2	18,3	21,4	24,4	27,4	m
3,5	22,300	18,475	-	-	-	-	3,5
4,0	20,650	17,625	-	-	-	-	4,0
4,5	17,725	16,300	-	-	-	-	4,5
5,0	15,000	14,200	-	-	-	-	5,0
6,0	10,950	10,975	10,075	9,295	-	-	6,0
7,0	8,280	8,270	7,860	7,305	-	-	7,0
8,0	6,370	6,340	6,100	5,775	5,965	-	8,0
9,0	4,940	4,915	4,750	4,560	4,800	4,940	9,0
10,0	3,825	3,815	3,690	3,500	3,850	4,025	10,0
12,0	-	2,240	2,125	1,920	2,395	2,615	12,0
14,0	-	-	1,025	0,870	1,330	1,535	14,0
16,0	-	-	-	-	0,505	0,740	16,0

AG-829-103683



85%

m	12,6	15,2	18,3	21,4	24,4	27,4	m
3,5	22,300	18,475	-	-	-	-	3,5
4,0	21,100	17,625	-	-	-	-	4,0
4,5	19,325	16,375	-	-	-	-	4,5
5,0	17,375	14,800	-	-	-	-	5,0
6,0	12,775	12,250	12,025	9,985	-	-	6,0
7,0	9,760	9,780	9,335	9,340	-	-	7,0
8,0	7,600	7,595	7,345	7,400	7,250	-	8,0
9,0	5,985	5,985	5,825	5,700	6,145	5,530	9,0
10,0	4,725	4,745	4,625	4,425	4,990	5,240	10,0
12,0	-	2,955	2,855	2,640	3,235	3,395	12,0
14,0	-	-	1,550	1,455	1,965	2,150	14,0
16,0	-	-	-	-	1,010	1,255	16,0

AG-829-0103679

Load charts • Tablas de carga • Tabelas de carga

Telescopic boom • Pluma telescópica • Lança telescópica



12,6 – 39,0 m



4 km/h



0°



8,2 t



DIN/ISO

m	12,6	15,2	18,3	21,4	24,4	27,4	m
3,5	26,950	22,400	-	-	-	-	3,5
4,0	25,300	22,400	-	-	-	-	4,0
4,5	22,875	22,400	-	-	-	-	4,5
5,0	21,050	20,900	-	-	-	-	5,0
6,0	17,550	17,425	16,725	13,475	-	-	6,0
7,0	15,050	14,925	14,550	13,475	-	-	7,0
8,0	12,375	12,200	11,950	11,975	-	-	8,0
9,0	9,945	9,745	9,600	9,750	10,050	-	9,0
10,0	8,125	7,915	7,830	7,940	8,280	-	10,0
12,0	-	5,370	5,365	5,370	5,780	6,130	12,0
14,0	-	-	3,735	3,665	4,090	4,425	14,0
16,0	-	-	2,575	2,455	2,885	3,190	16,0
18,0	-	-	-	1,550	1,985	2,265	18,0
20,0	-	-	-	-	1,290	1,550	20,0
22,0	-	-	-	-	0,730	0,980	22,0
24,0	-	-	-	-	-	0,510	24,0

AG-829-103684







85%



m	12,6	15,2	18,3	21,4	24,4	27,4	m
3,5	26,950	22,400	-	-	-	-	3,5
4,0	25,300	22,400	-	-	-	-	4,0
4,5	22,875	22,400	-	-	-	-	4,5
5,0	21,050	20,900	-	-	-	-	5,0
6,0	17,550	17,425	16,725	13,475	-	-	6,0
7,0	15,050	14,925	14,550	13,475	-	-	7,0
8,0	12,950	12,800	12,600	12,800	-	-	8,0
9,0	11,200	11,025	10,900	11,075	11,100	-	9,0
10,0	9,780	9,625	9,560	9,675	9,990	-	10,0
12,0	-	7,240	7,265	7,285	7,745	8,100	12,0
14,0	-	-	4,100	4,040	5,505	5,905	14,0
16,0	-	-	2,975	2,870	3,340	3,670	16,0
18,0	-	-	-	1,925	2,420	2,730	18,0
20,0	-	-	-	-	1,665	1,960	20,0
22,0	-	-	-	-	1,040	1,330	22,0
24,0	-	-	-	-	-	0,790	24,0

AG-829-103680

Load charts • Tablas de carga • Tabelas de carga

Swingaway • Plumín articulado • Oscilante

 12,6 - 39,0 m
  10,0 - 29,2 m
  100%
  360°
  8,2 t

 
 DIN / ISO

m	10,0 m			17,0 m			m
	0°	20°	40°	0°	20°	40°	
10,0	5,395	-	-	-	-	-	10,0
12,0	5,395	-	-	2,745	-	-	12,0
14,0	5,395	5,285	-	2,745	-	-	14,0
16,0	5,395	4,620	4,080	2,745	-	-	16,0
18,0	5,065	4,155	3,640	2,745	2,450	-	18,0
20,0	4,490	3,760	3,345	2,745	2,400	-	20,0
22,0	4,020	3,420	3,085	2,710	2,340	2,070	22,0
24,0	3,620	3,130	2,855	2,650	2,280	2,010	24,0
26,0	3,275	2,875	2,650	2,515	2,100	1,860	26,0
28,0	2,980	2,655	2,475	2,270	1,930	1,725	28,0
30,0	2,725	2,455	2,310	2,060	1,775	1,605	30,0
32,0	2,290	2,280	2,160	1,870	1,635	1,495	32,0
34,0	1,900	2,095	2,030	1,710	1,510	1,395	34,0
36,0	1,555	1,720	1,810	1,560	1,400	1,305	36,0
38,0	1,250	1,385	-	1,430	1,290	1,220	38,0
40,0	0,975	1,085	-	1,185	1,200	1,135	40,0
42,0	0,725	0,820	-	0,945	1,115	1,065	42,0
44,0	0,505	-	-	0,725	0,920	-	44,0
46,0	-	-	-	0,525	0,695	-	46,0

AG-829-0103695

m	23,1 m			29,2 m			m
	0°	20°	40°	0°	20°	40°	
16,0	2,200	-	-	-	-	-	16,0
18,0	2,200	-	-	1,595	-	-	18,0
20,0	2,200	2,220	-	1,595	-	-	20,0
22,0	2,200	2,125	-	1,595	1,695	-	22,0
24,0	2,155	1,905	1,835	1,595	1,585	-	24,0
26,0	1,945	1,710	1,580	1,485	1,395	1,460	26,0
28,0	1,730	1,540	1,440	1,295	1,235	1,195	28,0
30,0	1,540	1,395	1,310	1,120	1,085	1,060	30,0
32,0	1,375	1,255	1,190	0,970	0,950	0,935	32,0
34,0	1,230	1,135	1,085	0,840	0,835	0,830	34,0
36,0	1,100	1,025	0,985	0,720	0,725	0,730	36,0
38,0	0,985	0,925	0,895	0,615	0,630	0,635	38,0
40,0	0,880	0,835	0,815	0,520	0,540	0,550	40,0
42,0	0,785	0,745	0,735	-	-	-	42,0
44,0	0,700	0,670	0,665	-	-	-	44,0
46,0	0,545	0,595	0,595	-	-	-	46,0
48,0	-	0,530	0,535	-	-	-	48,0

AG-829-0103695 C







 
 85%



m	10,0 m			17,0 m			m
	0°	20°	40°	0°	20°	40°	
10,0	5,395	-	-	-	-	-	10,0
12,0	5,395	-	-	2,745	-	-	12,0
14,0	5,395	5,285	-	2,745	-	-	14,0
16,0	5,395	4,620	4,140	2,745	-	-	16,0
18,0	5,065	4,155	3,640	2,745	2,745	-	18,0
20,0	4,490	3,760	3,345	2,745	2,665	-	20,0
22,0	4,020	3,420	3,085	2,745	2,520	2,210	22,0
24,0	3,620	3,130	2,855	2,740	2,295	2,010	24,0
26,0	3,275	2,875	2,650	2,515	2,100	1,860	26,0
28,0	2,980	2,655	2,475	2,270	1,930	1,725	28,0
30,0	2,725	2,455	2,310	2,060	1,775	1,605	30,0
32,0	2,500	2,280	2,160	1,870	1,635	1,495	32,0
34,0	2,300	2,120	2,030	1,710	1,510	1,395	34,0
36,0	2,020	1,980	1,915	1,560	1,400	1,305	36,0
38,0	1,690	1,815	-	1,430	1,290	1,220	38,0
40,0	1,400	1,495	-	1,310	1,200	1,135	40,0
42,0	1,135	1,215	-	1,205	1,115	1,065	42,0
44,0	0,900	-	-	1,110	1,035	-	44,0
46,0	-	-	-	0,910	0,960	-	46,0

AG-829-0103695

Load charts • Tablas de carga • Tabelas de carga





Swingaway • Plumín articulado • Oscilante



 12,6 - 39,0 m
  10,0 - 29,2 m
  100%
  360°
  8,2 t

  85%

m	23,1 m			29,2 m			m
	0°	20°	40°	0°	20°	40°	
16,0	2,200	-	-	-	-	-	16,0
18,0	2,200	-	-	1,595	-	-	18,0
20,0	2,200	2,375	-	1,595	-	-	20,0
22,0	2,200	2,125	-	1,595	1,695	-	22,0
24,0	2,155	1,905	1,835	1,595	1,585	-	24,0
26,0	1,945	1,710	1,580	1,485	1,395	1,460	26,0
28,0	1,730	1,540	1,440	1,295	1,235	1,195	28,0
30,0	1,540	1,395	1,310	1,120	1,085	1,060	30,0
32,0	1,375	1,255	1,190	0,970	0,950	0,935	32,0
34,0	1,230	1,135	1,085	0,840	0,835	0,830	34,0
36,0	1,100	1,025	0,985	0,720	0,725	0,730	36,0
38,0	0,985	0,925	0,895	0,615	0,630	0,635	38,0
40,0	0,880	0,835	0,815	0,520	0,540	0,550	40,0
42,0	0,785	0,745	0,735	-	-	-	42,0
44,0	0,700	0,670	0,665	-	-	-	44,0
46,0	0,620	0,595	0,595	-	-	-	46,0
48,0	0,550	0,530	0,535	-	-	-	48,0

TAC-829-0103.6093 C

 12,6 - 39,0 m
  10,0 - 29,2 m
  50%
  360°
  8,2 t

  DIN/ISO

m	10,0 m			17,0 m			m
	0°	20°	40°	0°	20°	40°	
10,0	5,395	-	-	-	-	-	10,0
12,0	5,395	-	-	2,745	-	-	12,0
14,0	5,395	5,285	-	2,745	-	-	14,0
16,0	5,300	4,620	4,080	2,745	-	-	16,0
18,0	4,325	4,155	3,640	2,745	2,450	-	18,0
20,0	3,530	3,760	3,345	2,745	2,400	-	20,0
22,0	2,880	3,305	3,085	2,710	2,340	2,070	22,0
24,0	2,330	2,710	2,855	2,430	2,280	2,010	24,0
26,0	1,865	2,200	2,460	1,975	2,100	1,860	26,0
28,0	1,465	1,760	1,985	1,585	1,930	1,725	28,0
30,0	1,115	1,380	1,570	1,245	1,720	1,605	30,0
32,0	0,810	1,045	1,200	0,945	1,375	1,495	32,0
34,0	0,540	0,745	0,875	0,675	1,065	1,375	34,0
36,0	-	-	0,580	-	0,790	1,055	36,0
38,0	-	-	-	-	0,540	0,770	38,0
40,0	-	-	-	-	-	0,505	40,0

TAC-829-0103.6097

Symbols glossary • Glosario de símbolos • Glossário de símbolos

Symbols • Símbolos • Símbolos



Axles
Ejes
Eixos



Crane functions
Funciones de la grúa
Funções do Guindaste



Hookblock / Capacity
Aparejo de gancho/capacidad
Moitões de gancho/Capacidade



Speed
Velocidad
Velocidade



Axle load
Carga del eje
Capacidade do eixo



Crane travel
Propulsión de la grúa
Guindaste rodoviário



Hydraulic system
Sistema hidráulico
Sistema hidráulico



Suspension
Suspensión
Suspensão



Boom
Pluma
Lança



Drive/Steer
Tracción/dirección
Tração/direção



Lattice extension
Extensión de celosía
Extensão Treliçada



Transmission / Gear
Transmisión/marcha
Transmissão/Engrenagem



Boom elevation
Elevación de pluma
Elevação da lança



Electrical system
Sistema eléctrico
Sistema elétrico



Lattice extension (luffing)
Extensión de celosía (abatible)
Extensão treliçada (inclinável)



Travel speed
Velocidad de propulsión
Velocidade de viagem



Boom telescoping
Telescopización de la pluma
Lança telescópica



Engine
Motor
Motor



Luffing Jib
Plumín abatible
Jib com inclinação



Tyres
Neumáticos
Pneus



Brakes
Frenos
Freios



Free on wheels
Libre sobre ruedas
Livre sobre rodas



Low range
Marcha lenta
Marcha reduzida



Cab
Cabina
Cabine



Gradeability
Capacidad de pendiente
Capacidade de subida de rampa



Outriggers
Estabilizadores
Estabilizadores



Carrier frame
Bastidor de vehículo
Estrutura do transportador



Main hoist
Malacate principal
Guincho principal



Radius
Radio
Raio



Counterweight
Contrapeso
Contrapeso



Auxiliary hoist
Malacate auxiliar
Guincho auxiliar



Slewing/Working range
Gama de inclinación/trabajo
Faixa de giro/trabalho

Manitowoc Cranes

Regional headquarters

Americas

Manitowoc, Wisconsin, USA

Tel: +1 920 684 6621

Fax: +1 920 683 6277

Shady Grove, Pennsylvania, USA

Tel: +1 717 597 8121

Fax: +1 717 597 4062

Europe, Middle East, Africa

Ecully, France

Tel: +33 (0)4 72 18 20 20

Fax: +33 (0)4 72 18 20 00

China

Shanghai, China

Tel: +86 21 6457 0066

Fax: +86 21 6457 4955

Greater Asia-Pacific

Singapore

Tel: +65 6264 1188

Fax: +65 6862 4040

Regional offices

Chile

Santiago

Manitowoc Cranes

America del Sur

Rosario Norte 615

Oficina 1801

Las Condes Santiago

Chile

Telefono 56 2 923 8500

Mexico

Monterrey

Manitowoc Crane Group Mexico

Ave. Lazaro Cardenas #1810 Piso 11

Oficina 1108

Torre Capitel Colonia

Paseo Residencial

CP. 64920, Monterrey, N.L.

Mexico

Telefono 52 8 113 53 0300

Brazil

Barueri

Rua São Paulo, 157

Alphaville Industrial,

Barueri SP

06465-130

Brazil

Telefone +55 11 3103 0228

This document is non-contractual. Constant improvement and engineering progress make it necessary that we reserve the right to make specification, equipment, and price changes without notice. Illustrations shown may include optional equipment and accessories and may not include all standard equipment.

Este documento no es contractual. El perfeccionamiento constante y el avance tecnológico hacen necesario que la empresa se reserve el derecho de efectuar cambios en las especificaciones, equipo y precios sin previo aviso. En las ilustraciones se puede incluir equipo y accesorios opcionales y es posible que no se muestre el equipo normal.

Este documento não se reveste de qualquer carácter contratual. A introdução constante de melhorias e o progresso da engenharia tornam necessário reservarmos o direito de introduzir alterações nas características técnicas, no equipamento e no preço sem qualquer aviso prévio. As ilustrações aqui apresentadas podem incluir equipamento e acessórios adicionais, podendo não incluir todo o equipamento padrão.