

MD 689 M40

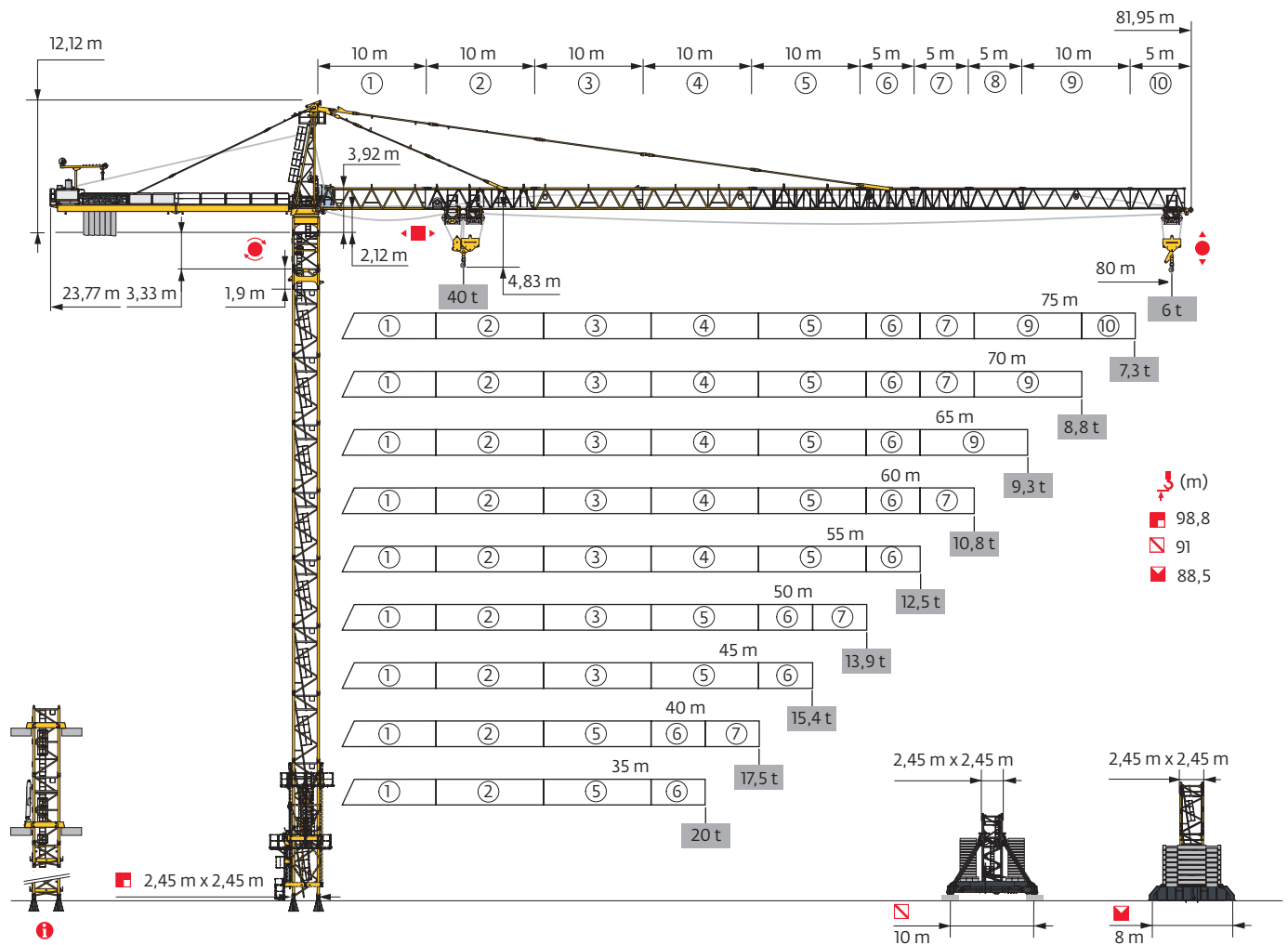

Potain Plus



Power Control

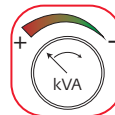

Top Site

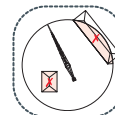

Anti-collision systems

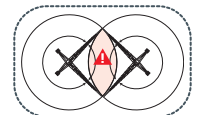

Mât - Réactions / Mast - Reaktionskräfte / Mast - Reactions / Mástil - Reacciones / Torre - Reazioni
 Tramo - Reacções / Реакция опор мачты

2,45 m - P 854A

ΔΥΔΛ (m)	35	40	45	50	55	60	65	70	75	80
↕ (m)	90,2	90,2	90,2	90,2	90,2	90,2	90,2	88,6	88,6	86,9
↕/P+ (m)	90,2	90,2	90,2	90,2	88,6	88,6	88,6	86,9	88,6	86,9
	3,33 m	1	1	1	1	1	1	1	1	1
	1,9 m	1	1	1	1	1	1	1	1	1
	3,33 m	2	2	2	2	2	2	0	0	1
	5 m	16	16	16	16	16	16	16	17	17
F2 (t)	● 370	370	372	372	366	366	361	371	366	369
	■ 498	497	498	496	500	507	502	482	485	500
F3 (t)	● 255	253	253	251	242	241	235	242	237	239
	■ 404	400	400	394	396	401	396	373	376	390

2,45 m - P 880A

ΔΥΔΛ (m)	35	40	45	50	55	60	65	70	75	80
↕ (m)	98,8	98,8	98,8	98,8	98,8	98,8	98,8	98,8	97,1	95,4
↕/P+ (m)	98,8	98,8	98,8	98,8	98,8	98,8	98,8	98,8	97,1	95,4
	3,33 m	1	1	1	1	1	1	1	1	1
	1,9 m	1	1	1	1	1	1	1	1	1
	3,33 m	0	0	0	0	0	0	0	1	2
	5 m	19	19	19	19	19	19	19	19	18
F2 (t)	● 420	419	418	418	425	427	424	429	418	423
	■ 654	653	657	655	664	675	666	675	644	666
F3 (t)	● 291	287	284	282	283	282	279	281	275	277
	■ 545	541	543	538	542	550	542	547	521	540

2,45 m - JM 850

ΔΥΔΛ (m)	35	40	45	50	55	60	65	70	75	80	
↕ (m)	81	87,7	87,7	86	82,7	86	87,7	79,3	91	84,3	
↕/P+ (m)	81	82,7	82,7	82,7	79,3	77,7	79,3	77,7	86	79,3	
	3,33 m	1	1	1	1	1	1	1	1	1	
	1,9 m	1	1	1	1	1	1	1	1	1	
	3,33 m	1	0	0	1	0	1	0	2	1	2
	5 m	13	15	15	14	14	14	15	12	15	13
F1 (t)	● 145	155	155	152	143	156	157	145	172	159	
	■ 167	195	195	187	171	191	195	160	216	197	

2,45 m - ZY 854

ΔΥΔΛ (m)	35	40	45	50	55	60	65	70	75	80
↕ (m)	88,5	88,5	88,5	88,5	88,5	86,9	88,5	86,9	86,9	85,2
↕/P+ (m)	88,5	88,5	88,5	88,5	86,9	86,9	86,9	86,9	86,9	85,2
	3,33 m	1	1	1	1	1	1	1	1	1
	1,9 m	1	1	1	1	1	1	1	1	1
	3,33 m	1	1	1	1	1	2	1	2	0
	5 m	16	16	16	16	16	15	16	15	15
F1 (t)	● 219	219	221	222	220	223	220	226	222	222
	■ 272	271	272	270	274	269	277	269	273	276

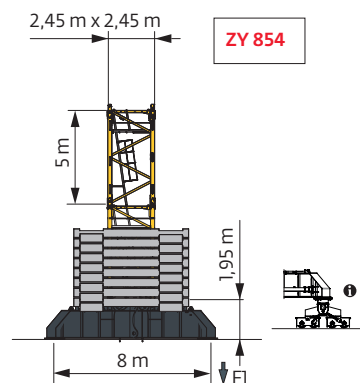
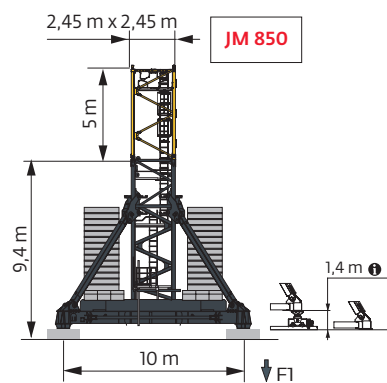
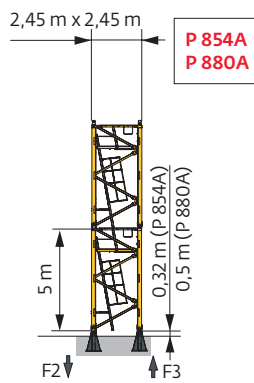

i Autres compositions de pylône - Nous consulter. / Andere Turmaufbauten - bitte kontaktieren Sie uns. / Other mast compositions - Please consult us. / Para otras composiciones de mástil - Por favor contáctenos. / Per altre composizioni torre, contattateci. / Para outras composições de coluna - Por favor, consulte-nos. / Для других композиций мачты пожалуйста консультируйтесь с нами.

Accès motorisés : compositions de mât, de lest de base et réactions adaptées. / Motorisierter Zugang vom Mastzusammensetzung, Grundballast und Reaktionskräfte sind angepasst. / Motorized accesses: adapted mast composition, base ballast and reactions. / Acceso a cabina con elevador: Adaptación de composición de mástil, lastre de base y reacciones. / Accessi motorizzati: composizioni elementi torre, zavorre di base e reazioni aggiornate. / Acessos motorizados: composições de coluna, lastro da base e reacções adaptadas. / Лифты : адаптированная композиция мачты, базовый балласт и нагрузки.



Ancrages / Verankerungen / Anchorages / Anclajes / Ancoraggi
Ancoragem / нкера

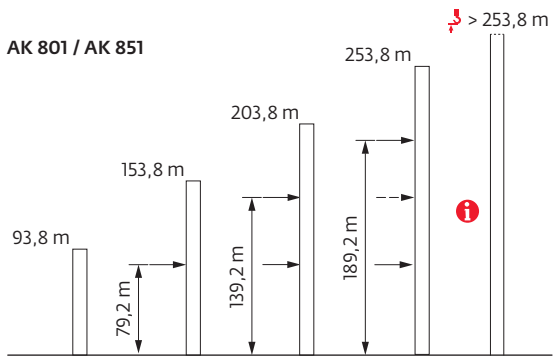

P 880A

AK 801 / AK 851



Lest de base / Grundballast / Base ballast / Lastre de base / Zavorra di base
 Lastro da base / Базовый Балласт

 (t) /  2,45 m - JM 850 - 										
h _{max} (m)	35	40	45	50	55	60	65	70	75	80
91										120
87,7		96	96				84		84	
86		96	84	84		84	72		72	
84,3		84	84	72		72	60		60	84
82,7		72	72	60	48	48	48		48	72
81	72	60	60	48	48	48	48		48	60
79,3	60	48	48	48	48	48	48	48	48	48
74,3	48	48	48	48	48	48	48	48	48	48
69,3	48	48	48	48	48	48	48	48	48	48
64,3	48	48	48	48	48	48	48	48	48	48
59,3	48	48	48	48	48	48	48	48	48	48
54,3	48	48	48	48	48	48	48	48	48	48
49,3	48	48	48	48	48	48	48	48	48	48
44,3	48	48	48	48	48	48	48	48	48	48
39,3	48	48	48	48	48	48	48	48	48	48
34,3	48	48	48	48	48	48	48	48	48	48
29,3	48	48	48	48	48	48	48	48	48	48
24,3	48	48	48	48	48	48	48	48	48	48
19,3	48	48	48	48	48	48	48	48	48	48

 (t) /  2,45 m - ZY 854 - 										
h _{max} (m)	35	40	45	50	55	60	65	70	75	80
88,5	192	180	180	180	168		168			
86,9	180	168	168	168	156	156	156	156	168	
85,2	168	156	156	144	144	144	144	132	144	168
80,2	132	120	120	120	120	120	120	108	96	132
75,2	108	108	108	108	108	96	96	96	84	96
70,2	96	96	96	84	84	84	84	84	84	96
65,2	84	84	84	84	72	72	72	84	84	84
60,2	72	72	72	72	72	72	72	84	84	84
55,2	72	72	72	72	72	72	72	72	84	84
50,2	72	72	72	72	72	72	72	72	72	84
45,2	72	72	72	72	72	72	72	72	72	84
40,2	72	72	72	72	72	72	72	72	72	72
35,2	72	72	72	72	72	72	72	72	72	72
30,2	72	72	72	72	72	72	72	72	72	72
25,2	72	72	72	72	72	72	72	72	72	72
20,2	72	72	72	72	72	72	72	72	72	72

Courbes de charges / Lastkurven / Load curves / Curvas de cargas / Curve di carico / Curvas de carga / Кривые нагрузок



▼▲▲▲▲ (m)		12	15	22	25	30	35	37	40	45	47	50	55	57	60	65	67	70	72	75	77	80	m	
▼▲▲▲	▼▲▲▲ 40 t	▼▲▲▲										▼▲▲▲												
▼▲▲▲	▼▲▲▲ 20 t	▼▲▲▲										▼▲▲▲												
80	3,9 → 15,5	27,1 - 29,6	40	40	26,1	22,2	19,7	16,4	15,3	13,9	12,1	11,4	10,6	9,3	8,9	8,3	7,4	7,1	6,7	6,4	6	5,7	5,4	t
	3,9 → 16	28,5 - 31,2	40	40	27,5	23,6	20	17,5	16,4	15	13,1	12,4	11,5	10,2	9,8	9,2	8,2	7,9	7,4	7,1	6,7	6,4	6	t P+
75	3,9 → 16,2	26,8 - 28,6	40	40	26,4	22,1	18,8	15,2	14,1	12,6	11,3	10,9	10,3	9,4	9,1	8,7	7,9	7,6	7,2	7	6,6		t	
	3,9 → 17,2	28,5 - 30,7	40	40	29	24,3	20	16,6	15,3	13,9	12,3	11,9	11,3	10,4	10	9,6	8,7	8,4	7,9	7,6	7,3	t	P+	
70	3,9 → 18,3	29,8 - 31,1	40	40	30,9	25,8	20	17,5	16,4	15	13	12,3	11,5	10,6	10,2	9,7	8,9	8,5	8			t		
	3,9 → 18,4	31,7 - 32,5	40	40	32,9	28,4	21,8	18	16,7	15,2	13,6	13,1	12,6	11,7	11,3	10,7	9,8	9,4	8,8			t	P+	
65	3,9 → 17,5	30,5 - 32,7	40	40	30,2	25,8	20,5	18,5	17,3	15,7	13,6	12,9	11,9	10,5	10,1	9,4	8,5					t		
	3,9 → 18,4	32,9 - 34,4	40	40	33,1	28,4	22,5	19,5	18,2	16,6	14,8	14,1	13,1	11,6	11,1	10,3	9,3					t	P+	
60	3,9 → 17,4	30,9 - 33,2	40	40	30,3	26	20,8	18,8	17,6	16,1	14	13,3	12,3	10,9	10,5	9,8						t		
	3,9 → 18,1	33,4 - 35,1	40	40	32,5	28,1	22,7	20	18,6	17	15,1	14,6	13,5	12	11,5	10,8						t	P+	
55	3,9 → 17,8	32,1 - 34,5	40	40	31,4	27	21,7	19,7	18,5	16,9	14,7	14	13	11,6								t		
	3,9 → 18,5	34,1 - 36,3	40	40	33,1	28,7	23,2	20	19,6	18	15,7	15	14	12,5								t	P+	
50	3,9 → 17,6	32 - 34,5	40	40	31	26,8	21,6	19,7	18,5	16,9	14,8	14,1	13,1									t		
	3,9 → 18,5	34,1 - 36,3	40	40	33,1	28,6	23,2	20	19,6	17,9	15,7	15	13,9									t	P+	
45	3,9 → 17,4	31,6 - 34,1	40	40	30,6	26,4	21,3	19,4	18,2	16,7	14,6											t		
	3,9 → 18,2	33,6 - 35,7	40	40	32,5	28,1	22,8	20	19,2	17,6	15,4											t	P+	
40	3,9 → 17,6	32 - 34,4	40	40	31	26,7	21,6	19,6	18,5	16,9												t		
	3,9 → 18,2	33,5 - 35,6	40	40	32,3	28	22,7	20	19,1	17,5												t	P+	
35	3,9 → 17,7	32,5 - 35	40	40	31,4	27,1	22	20															t	
	3,9 → 18	33,1 - 35	40	40	31,9	27,6	22,4	20															t	P+

▼▲▲▲ = ▼▲▲▲ - 2,13 t max.

Poids de flèche & lest de contre-flèche / Auslegergewicht & Gegenauslegerballast / Jib weight & counter-jib ballast / Peso de flecha y lastre de contra-flecha/Peso del braccio & zavorra di contro-braccio/Peso da lança & lastro da contra lança/Вес стрелы и балласт контр-стрелы

▼▲▲▲	▼▲▲▲ (kg)	▼▲▲▲		▼▲▲▲ (kg)
	(+/- 5%)	6000 kg	4000 kg	
80 m	28760	6	0	36000
75 m	27755	6	0	36000
70 m	27205	5	1	34000
65 m	26080	5	0	30000
60 m	25810	4	1	28000
55 m	24685	3	2	26000
50 m	23040	2	2	20000
45 m	21920	2	1	16000
40 m	20030	1	2	14000
35 m	18910	1	1	10000

CBC - 6000 kg

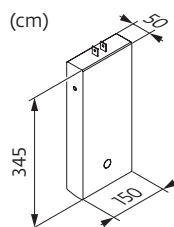

CBD - 4000 kg

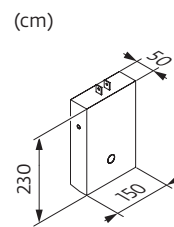





Encombrenment et poids / Abmessungen und Gewicht / Dimensions and weight / Dimensiones y peso / Ingombro e peso
 dimensões e pesos / габаритные размеры и вес

Partie tournante / Drehender Kranteil / Slewing crane part / Parte giratoria

Parte rotante / Parte rotativa / Поворотная часть : 80 m - 270/320 LVF

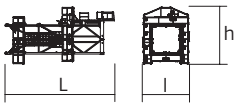
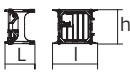
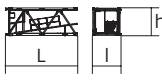
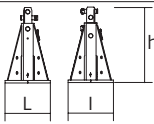
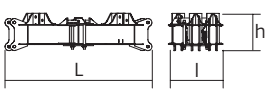
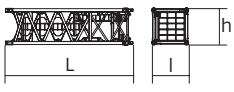
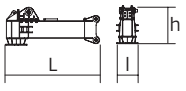
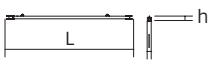

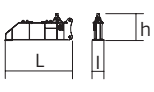
Partie tournante / Drehender Kranteil / Slewing crane part Parte giratoria / Parte rotante / Поворотная часть	L (m)	l (m)	h (m)	kg (+/- 5%)		
Contre-flèche / Gegenausleger Counter-jib / Contra-flecha Controbraccio / Contra-lança Контр-стрела		11,7	4,7	1,96	6600	
		11,04	3,74	2,07	4925	
Porte-flèche / Auslegerträger Cathead / Porta-flecha Cuspide / Suporte de lança Оголовок		3,54	1,99	9,86	8265	
Cabine / Kabine Cab / Cabina Cabina / Cabina Кабина	Ultra View	5	2,5	2,77	1875	
Pivot / Krankopf Towerhead / Pivote Portaralla / Pivot Секция поворотной части	2,45 m	3,7	2,9	3,87	11560	
Treuil de levage (+ câble) / Hubwerk (+ Seil) Hoisting winch (+ rope) / Mecanismo de elevación (+ cabo) Argano di sollevamento (+ fune) Guincho de elevação (+ cabo) Подъемная лебедка (+ канатом)	270/320 LVF	5,09	2,3	2,24	9885	
Châssis intermédiaire de treuil / Zwischenrahmen des Triebwerks Intermediate winch frame / Chassis intermedio del mecanismo Chassis intermedio / Chassis intermédio do guincho средняя часть рамы лебедки		3,26	2,89	1,66	5663	
Elément de flèche / Auslegerelement Jib section / Elemento de flecha Elemento di braccio / Elemento de lança Секция стрелы		①	10,36	1,9	2,54	5100
		② 15 DVF	10,33	1,9	2,34	5415
		③	10,23	1,9	2,4	3010
		④	10,23	1,9	2,33	2770
		⑤	10,23	1,9	2,32	2850
⑨	10,21	1,9	2,02	1395		
Elément de flèche / Auslegerelement Jib section / Elemento de flecha Elemento di braccio / Elemento de lança Секция стрелы		⑥	5,32	1,9	2,25	1915
		⑦	5,24	1,9	2,04	1125
		⑧	5,24	1,9	2,04	1005
		⑩	5,18	1,9	1,97	550
Chariot / Laufkatze Trolley / Carrello Carro / Carro-distribuidor Тележка	40 t	3,95	2,19	1,67	1420	
Moufle / Hubflasche Pulley block / Aparejo Bozzello / Cadernal Полиспаст	40 t	2,47	0,36	2,88	1837	

Рубіне / Kranturm / Crane tower Mástil / Torre / Torre Башня крана		L (m)	I (m)	h (m)	kg (+/- 5%)	
T 851		2,45	11,18	4,84	5,8	15750
K 85/K 85-2 Mât de télescage / Teleskopiermast Telescoping mast / Tramo de telescage Elemento di telescaggio / Tramo de Telescagem Мачта для телескопирования		2,45	2,22	3,25	2,5	3600
KM 850.10B KM 850.14B KMT 850.10A KMT 850.14A K 88/K 85A2 KM 880.10A KMT 880.10A KMT 850.10C		2,45	10,32 10,32 5,32 5,32 5,32 5,41 5,41 3,65	2,54 2,54 2,54 2,54 2,51 2,53 2,53 2,54	2,51 2,51 2,51 2,51 2,51 2,53 2,62 2,51	10070 11190 5450 5990 8290 8370 8700 4230
Pieds de scellement / VerankerungsfüÙe Fixing angles / Pie de empotramiento Montante da annegare / Angulos fixadores анкера		P 854A P 880A	0,9 1	0,9 1	1,5 1,87	940 1605
Croix centrale (position transport) / Zentralkreuz (Transport- position) / Central cross (transport position) / Brazo central (posición transporte) / Croce centrale (posizione di trasporto) Braço central chassis (posição transporte) / крестообразное основание (транспортное положение)		JM 850	5,2	1,7	1,5	6700
Mât-châssis / Grundmasteinheit Basic mast unit / Tramo-chasis Elemento base / Tramo-chassis Мачта для крепления к шасси		JM 850	8,75	2,5	2,5	14600
Bras de châssis / Unterwagenträger / Chassis girder / Brazo de base en cruz / Traverso del carro / Braço de chassis / опорная балка шасси		JM 850	5,2	0,9	1,55	3200
Tirant de châssis / Unterwagenstreben / Chassis ties / Tirante de base en cruz / Tiranti del carro / Tirante de chassis / тяга крепления шасси		JM 850	7,2	0,25	0,35	250
Haubans / Mastabstützungen Struts / Tornapuntas Puntoni / Escoras Растяжка		JM 850	8,2	0,75	1,3	2300
1/2 Bras de croix / 1/2 Fundamentkreuzträger 1/2 Cross girder / 1/2 Brazo en cruz 1/2 Braccio croce / 1/2 Braço da cruz 1/2 Поперечная балка		ZY 854	5,7	0,98	2,27	6430
Bras de croix / Fundamentkreuzträger Cross girder / Brazo en cruz Braccio croce / Braço da cruz Поперечная балка		ZY 854	11,9	1,42	2,27	14000

Mécanismes / Triebwerke / Mechanisms / Mecanismos / Meccanismi
 Mecanismos / Механизмы

400 V - 50 Hz 480 V - 60 Hz													ch - PS hp	kW		
	400 V - 50 Hz	270 LVF 100 Optima	m/min	51	66,5	96	139	162	25,5	33,5	49	71	81	270	200	532 m
			t	20	15	10	5	3,5	40	30	20	10	8			
	480 V - 60 Hz	320 LVF 100 Optima	m/min	67	86	118	148	162	34	43	60	74	81	320	240	
			t	20	15	10	6,8	6	40	30	20	14,2	12,7			
		15 DVF 16 Optima	m/min	0 → 33 (40 t) 0 → 50 (20 t) 0 → 67 (10 t) 0 → 100 (2,5 t)									15	11		
	400 V - 50 Hz 480 V - 60 Hz	RVF 173 Optima+	tr/min U/min rpm	400 V - 50 Hz : 0 → 0,7 480 V - 60 Hz : 0 → 0,8									3 x 10	3 x 7,5		

	IEC 60204-32		
	400 V (+10% -10%) 50 Hz		257 → 149 kVA
	480 V (+6% -10%) 60 Hz		297 → 169 kVA

	FR	DE	EN	ES	IT	PT	RU
	Équipements standards	Standardausrüstungen	Standard equipment	Equipamiento de serie	Equipaggiamento standard	Equipamento de série	Стандартное оборудование
	Équipements optionnels	Sonderausrüstungen	Options	Equipamiento opcional	Equipaggiamento in opzione	Equipamento opcional	Дополнительное оборудование (опция)
	Fonction Potain Plus : Courbes de charges Plus	Funktion Potain Plus: Plus-Lastkurven	Potain Plus function: Plus load curves	Función Potain Plus: Diagrama de cargas Plus	Funzione Potain Plus: Curve di carico Plus	Função Potain Plus: Diagrama de cargas Plus	Функция контроля мощности Potain Plus: Диаграммы грузоподъемности Plus
	Hauteurs sous crochet associées aux courbes de charges Plus	Hakenhöhen mit Plus-Lastkurven	Hook heights with Plus load curves	Altura bajo gancho, usando el diagrama de cargas Plus	Altezze sotto gancio con curve di diagrama de cargas Plus	Altura livre, utilizando o diagrama de cargas Plus	Высота под крюком для диаграмм грузоподъемности Plus
	Réactions en service	Reaktionskräfte in Betrieb	Reactions in service	Reacciones en servicio	Reazioni in servizio	Reacções em serviço	Реакция при работе
	Réactions hors service	Reaktionskräfte außer Betrieb	Reactions out of service	Reacciones fuera de servicio	Reazioni fuori servizio	Reacções fora de serviço	Реакция в покое
	Poids total du lest	Ballast-Gesamtgewicht	Total ballast weight	Peso total del lastre	Peso totale della zavorra	Peso total do lastro	Общий вес балласта
	Cadre d'ancrage serré	Fester Verankerungsrahmen	Tightened anchorage frame	Marco de anclaje de apriete	Quadro di ancoraggio stretto	Quadro de amarração apertado	Прикрепленная анкерная рама
	Cadre d'ancrage desserré	Loser Verankerungsrahmen	Loosened anchorage frame	Marco de anclaje de desapriete	Quadro di ancoraggio allentato	Quadro de amarração solto	Отсоединенная анкерная рама
	Poids de flèche	Auslegergewicht	Jib weight	Peso de flecha	Peso del braccio	Peso da lança	вес стрелы
	Camion 13,4 m	Lkw 13,4 m	Lorry 13,4 m	Camión 13,4 m	Camión 13,4 m	Camião 13,4 m	Ррузовой автомобиль 13,4 м
	Conteneur High Cube 40', et/ou Flat Rack 20'	Container High Cube 40', und/oder Flat Rack 20'	Container High Cube 40', and/or Flat Rack 20'	Contenedor High Cube 40', y/o Flat Rack 20'	Container High Cube 40', e/o Flat Rack 20'	Contentor High Cube 40', e/ou Flat Rack 20'	40-футовый контейнер повышенной вместимости High Cube, и/или 20-футовая открытая платформа Flat Rack
	Levage	Heben	Hoisting	Elevación	Sollevamento	Elevação	Подъем
	Distribution	Katzfahren	Trolleying	Distribución	Ditribuzione	Distribuição	Перемещение по стреле
	Orientation	Schwenken	Slewing	Orientación	Rotazione	Rotação	Поворот
	Translation	Kranfahren	Travelling	Traslación	Traslazione	Translação	Перемещение крана
	Puissance requise	Erforderliche Leistung	Required power	Potencia Necesaria	Potenza richiesta	Potência Necessária	Потребляемая мощность
	Fonction Power Control : vitesses treuils adaptées à la puissance disponible	Funktion Power Control: Geschwindigkeiten der Triebwerke werden an die verfügbare Leistung angepasst	Power Control Function: winch speeds adapted to the available power	Función Power Control: marchas de los cabrestantes adaptadas a la potencia disponible	Funzione Power Control: velocità degli argani adattate alla potenza disponibile	Função Power Control: velocidades de guincho adaptadas à potência disponível	Функция контроля мощности Power Control: регулировка скорости лебедок в зависимости от доступной мощности
	Nous consulter	Auf Anfrage	Consult us	Consultarnos	Consultateci	Consultar-nos	Проконсультируйтесь у нас
	Document commercial non contractuel. Pour toute information technique se référer à la notice correspondante.	Unverbindliches Vertriebsdokument. Für technische Informationen, siehe die entsprechenden Anweisungen.	This commercial document is not legally binding. For any technical information, please refer to the corresponding instructions.	Documento comercial no contractual. Para cualquier información técnica, ver la noticia correspondiente.	Documento commerciale non vincolante, per tutte le informazioni tecniche fare riferimento al catalogo istruzioni.	Documento comercial não contratual. Para qualquer informação técnica complementar consultar as respectivas instruções.	Этот коммерческий документ не является юридически обязательным. Для получения технической информации, см. соответствующие инструкции.

