

## MDT 349 L12

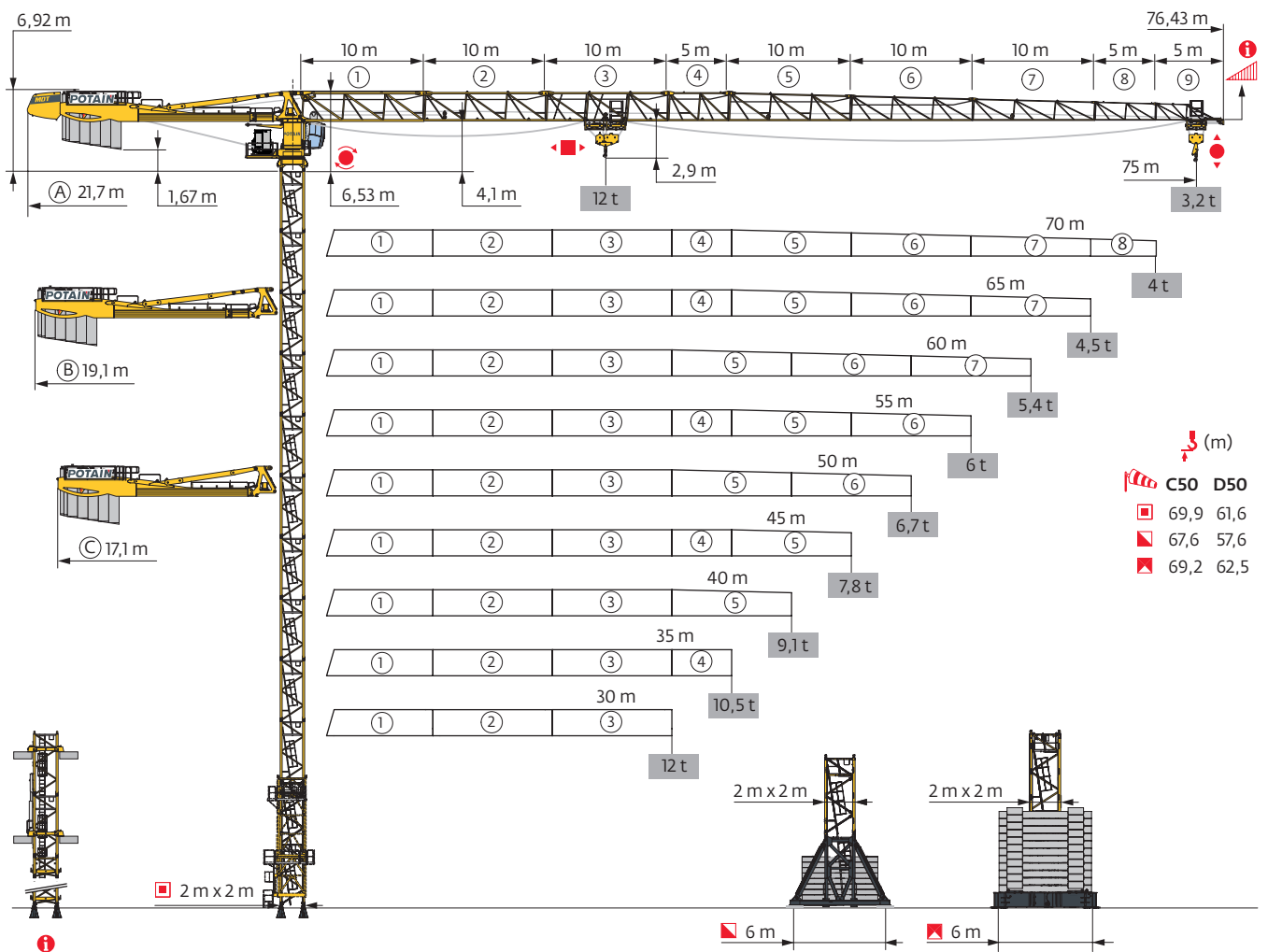

Potain Plus



Power Control

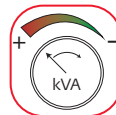

POTAIN®  
CONNECT



Top Site

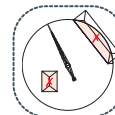

Anti-collision systems

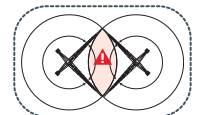

Mât - Réactions / Mast - Reaktionskräfte / Mast - Reactions / Mástil - Reacciones / Torre - Reazioni  
 Tramo - Reacções / Реакция опор мачты

**2 m - P 63A - C50**

ΔΔΔΔ (m)	30	35	40	45	50	55	60	65	70	75
↕ (m)	69,9	69,9	69,9	68,2	68,2	68,2	68,2	66,6	66,6	66,6
↕/P+ (m)	69,9	69,9	69,9	68,2	68,2	68,2	68,2	66,6	66,6	66,6
	3,33 m	1	1	1	2	2	2	0	0	0
	5 m	11	11	11	10	10	10	11	11	11
	10 m	1	1	1	1	1	1	1	1	1
F2 (t)	● 203	209	210	204	208	205	205	200	208	206
	■ 350	356	356	336	343	344	348	336	342	349
F3 (t)	● 144	148	147	141	144	141	141	137	144	142
	■ 297	300	299	279	285	287	291	278	284	291
↕ (m) D50	61,6	61,6	61,6	61,6	61,6	61,6	61,6	59,9	59,9	59,9
↕/P+ (m) D50	61,6	61,6	61,6	61,6	61,6	61,6	61,6	59,9	59,9	59,9

**2 m - V 60A - C50**

ΔΔΔΔ (m)	30	35	40	45	50	55	60	65	70	75
↕ (m)	62,5	62,5	62,5	64,2	62,5	62,5	62,5	62,5	60,9	60,9
↕/P+ (m)	62,5	62,5	62,5	64,2	62,5	62,5	62,5	62,5	60,9	60,9
	3,33 m	2	2	1	2	2	2	2	0	0
	5 m	10	10	10	11	10	10	10	11	11
	F1 (t)	● 111	113	114	115	114	113	113	116	115
	■ 141	143	142	148	144	145	147	151	147	152
↕ (m) D50	54,2	54,2	54,2	54,2	54,2	54,2	54,2	52,5	52,5	50,9
↕/P+ (m) D50	54,2	54,2	54,2	54,2	54,2	54,2	54,2	52,5	52,5	50,9

**2 m - V 63A - C50**

ΔΔΔΔ (m)	30	35	40	45	50	55	60	65	70	75
↕ (m)	67,6	67,6	69,2	67,6	67,6	67,6	67,6	65,9	65,9	65,9
↕/P+ (m)	67,6	67,6	69,2	67,6	67,6	67,6	67,6	65,9	65,9	65,9
	3,33 m	2	2	1	2	2	2	0	0	0
	5 m	10	10	11	10	10	10	11	11	11
	F1 (t)	● 129	131	133	127	129	127	130	129	130
	■ 173	175	184	172	176	177	179	173	179	183
↕ (m) D50	57,6	57,6	57,6	57,6	57,6	57,6	57,6	57,6	55,9	55,9
↕/P+ (m) D50	57,6	57,6	57,6	57,6	57,6	57,6	57,6	57,6	55,9	55,9

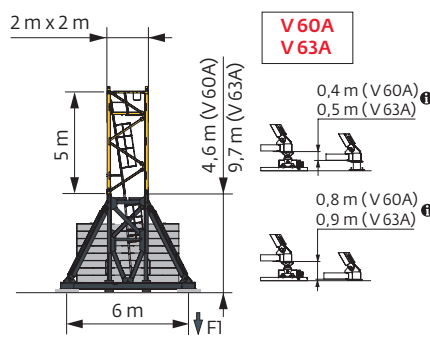
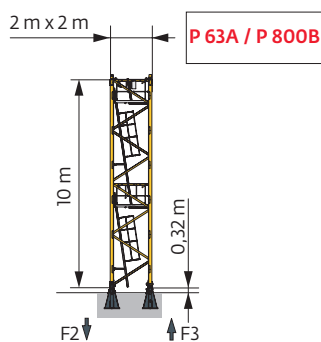

**i** Autres compositions de pylône - Nous consulter. / Andere Turmaufbauten - bitte kontaktieren Sie uns. / Other mast compositions - Please consult us. / Para otras composiciones de mástil - Por favor contactémos. / Per altre composizioni torre, contattateci. / Para outras composições de coluna - Por favor, consulte-nos. / Для других композиций мачты пожалуйста консультируйтесь с нами.

Accès motorisés : compositions de mât, de lest de base et réactions adaptées. / Motorisierter Zugang vom : Mastzusammensetzung, Grundballast und Reaktionskräfte sind angepasst. / Motorized accesses: adapted mast composition, base ballast and reactions. / Acceso a cabina con elevador: Adaptación de composición de mástil, lastre de base y reacciones. / Accessi motorizzati: composizioni elementi torre, zavorre di base e reazioni aggiornate. / Acessos motorizados: composições de coluna, lastro da base e reacções adaptadas. / Лифты : адаптированная композиция мачты, базовый балласт и нагрузки.

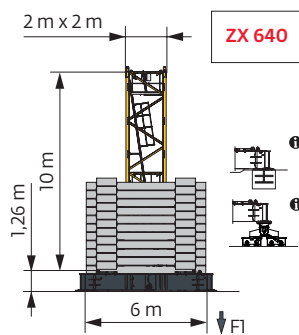

2 m - ZX 640 - C50										
h (m)	30	35	40	45	50	55	60	65	70	75
$h$ (m)	69,2	69,2	69,2	67,5	67,5	67,5	67,5	67,5	65,9	65,9
$h/P$ (m)	69,2	69,2	69,2	67,5	67,5	67,5	67,5	67,5	65,9	65,9
	3,33 m	2	2	0	0	0	0	0	1	1
	5 m	10	10	10	11	11	11	11	10	10
	10 m	1	1	1	1	1	1	1	1	1
Fl (t)	● 128	131	132	127	128	127	127	131	129	131
	■ 175	178	178	164	169	169	172	176	171	175
$h$ (m) D50	62,5	62,5	62,5	62,5	62,5	62,5	62,5	60,9	60,9	59,2
$h/P$ (m) D50	62,5	62,5	62,5	62,5	62,5	62,5	62,5	60,9	60,9	59,2









Ancrages / Verankerungen / Anchorages / Anclajes / Ancoraggi  
 Ancoragem / нкре



Lest de base / Grundballast / Base ballast / Lastre de base / Zavorra di base  
 Lastro da base / Базовый Балласт

 (t) /  2 m - V 60A -  - C50										
h <sub>ballast</sub> (m)	30	35	40	45	50	55	60	65	70	75
64,2	132									
62,5	132	132	132	132	132	132	132	132		
60,9	132	120	120	120	120	120	120	132	132	132
55,9	108	108	108	108	108	96	96	108	108	108
50,9	96	96	84	84	84	84	84	96	84	84
45,9	84	72	72	72	72	72	72	72	72	72
40,9	60	60	60	60	60	60	48	60	60	60
35,9	60	60	60	48	48	48	48	48	48	60
30,9	60	60	60	48	48	48	48	48	48	60
25,9	60	60	60	48	48	48	48	48	48	60
20,9	60	60	60	48	48	48	48	48	48	60

 (t) /  2 m - V 63A -  - C50										
h <sub>ballast</sub> (m)	30	35	40	45	50	55	60	65	70	75
69,2	180									
67,6	180	180	168	168	168	168	180			
65,9	156	156	156	156	156	156	156	168	168	180
60,9	132	120	120	120	120	120	120	132	132	144
55,9	108	108	108	108	108	96	96	108	108	108
50,9	96	96	96	84	84	84	84	96	96	96
45,9	84	72	72	72	72	72	72	72	72	72
40,9	72	60	60	60	60	60	60	60	60	60
35,9	60	60	60	48	48	48	48	48	48	60
30,9	48	60	60	48	48	48	36	48	48	60
25,9	48	60	60	48	48	48	36	36	48	60
20,9	48	60	60	48	48	48	36	36	48	60

 (t) /  2 m - ZX 640 -  - C50										
h <sub>ballast</sub> (m)	30	35	40	45	50	55	60	65	70	75
69,2	170	170	170							
67,5	160	160	150	160	160	160	160	170		
65,9	150	150	150	150	150	150	150	150	160	170
60,9	130	130	130	130	130	130	130	120	140	140
55,9	110	110	110	110	110	110	110	110	120	110
50,9	100	90	90	90	90	90	90	90	90	90
45,9	80	80	80	80	70	70	70	70	80	70
40,9	60	60	60	60	60	60	60	50	60	60
35,9	50	60	60	50	50	40	40	40	40	50
30,9	50	60	60	50	50	40	40	40	40	50
25,9	50	60	60	50	50	40	40	40	40	50
20,9	50	60	60	50	50	40	40	40	40	50

Courbes de charges / Lastkurven / Load curves / Curvas de cargas / Curve di carico / Curvas de carga / Кривые нагрузок



↕ (m)		22	27	30	32	35	37	40	42	45	47	50	52	55	57	60	62	65	67	70	72	75	m	
↕	↕ 12 t	↕											↕											
↕	↕ ↕ 6 t	↕											↕											
75	3,1 → 22,4	39,8 - 43,3	12	9,6	8,5	7,9	7,1	6,6	6	6	5,7	5,4	5,1	4,8	4,5	4,3	4	3,8	3,6	3,4	3,2	3,1	2,85	t
	3,1 → 23	40,8 - 44,4	12	9,9	8,8	8,1	7,3	6,8	6,2	6	5,9	5,6	5,2	5	4,7	4,5	4,2	4	3,8	3,7	3,5	3,3	3,2	t P+
70	3,1 → 24	42,7 - 46,2	12	10,4	9,2	8,5	7,7	7,2	6,5	6,1	6	5,9	5,5	5,2	4,8	4,6	4,3	4,1	3,9	3,7	3,5			t
	3,1 → 25,6	45,5 - 49,3	12	11,2	9,9	9,2	8,3	7,7	7	6,6	6,1	6	5,9	5,6	5,3	5,1	4,8	4,6	4,3	4,2	4			t P+
65	3,1 → 25,4	45,5 - 49,2	12	11,2	9,9	9,2	8,2	7,7	7	6,6	6,1	6	5,9	5,6	5,2	5	4,6	4,4	4,1					t
	3,1 → 26,8	48,1 - 52	12	11,9	10,5	9,8	8,8	8,3	7,5	7,1	6,5	6,2	6	6	5,6	5,4	5	4,8	4,5					t P+
60	3,1 → 26,8	48,3 - 52,1	12	11,9	10,5	9,8	8,8	8,3	7,5	7,1	6,5	6,2	6	6	5,6	5,4	5,1							t
	3,1 → 28,1	50,8 - 55	12	12	11,2	10,4	9,3	8,8	8	7,5	6,9	6,6	6,1	6	6	5,7	5,4							t P+
55	3,1 → 27,5	49,6 - 53,4	12	12	10,9	10,1	9,1	8,5	7,8	7,3	6,7	6,4	6	6	5,8									t
	3,1 → 29,1	52,6 - 55	12	12	11,6	10,8	9,7	9,1	8,3	7,9	7,2	6,9	6,4	6,1	6									t P+
50	3,1 → 28,7		12	12	11,4	10,6	9,6	9	8,2	7,8	7,2	6,8	6,3											t
	3,1 → 30,1		12	12	12	11,2	10,1	9,5	8,7	8,2	7,5	7,2	6,6											t P+
45	3,1 → 29,4		12	12	11,7	10,9	9,8	9,2	8,4	8	7,3													t
	3,1 → 30,8		12	12	12	11,5	10,4	9,7	8,9	8,4	7,7													t P+
40	3,1 → 29,8		12	12	11,9	11	10	9,4	8,5															t
	3,1 → 31,2		12	12	12	11,7	10,5	9,9	9															t P+
35	3,1 → 29,6		12	12	11,8	11	9,9																	t
	3,1 → 31		12	12	12	11,6	10,4																	t P+
30	3,1 → 29,9		12	12	11,9																			t
	3,1 → 29,9		12	12	11,9																			t P+

$↕ = ↕ - 0,61 \text{ t max.}$



↕ (m)		22	27	30	32	35	37	40	42	45	47	50	52	55	57	60	62	65	67	70	72	75	m	
↕	↕ 12 t	↕											↕											
↕	↕ ↕ 6 t	↕											↕											
75	2,4 → 22,5	40,2 - 41,1	12	9,7	8,6	7,9	7,1	6,6	6	5,8	5,4	5,1	4,7	4,5	4,1	3,9	3,6	3,5	3,2	3,1	2,85	2,7	2,5	t
	2,4 → 23,1	41,2 - 42,1	12	10	8,8	8,2	7,3	6,8	6,2	6	5,5	5,2	4,8	4,6	4,3	4,1	3,8	3,7	3,4	3,3	3,1	2,95	2,8	t P+
70	2,4 → 24	43 - 44	12	10,5	9,3	8,6	7,7	7,2	6,6	6,2	5,8	5,5	5,1	4,9	4,5	4,3	4	3,8	3,5	3,3	3,1			t
	2,4 → 25,6	45,8 - 47	12	11,3	10	9,3	8,3	7,8	7,1	6,7	6,1	6	5,5	5,3	4,9	4,7	4,4	4,2	4	3,8	3,6			t P+
65	2,4 → 25,5	45,8 - 47	12	11,2	9,9	9,2	8,3	7,8	7,1	6,7	6,1	6	5,5	5,3	4,9	4,6	4,3	4,1	3,8					t
	2,4 → 27	48,5 - 49,6	12	12	10,6	9,8	8,9	8,3	7,6	7,1	6,6	6,2	5,9	5,7	5,3	5	4,7	4,5	4,2					t P+
60	2,4 → 27	48,7 - 50	12	12	10,6	9,9	8,9	8,3	7,6	7,2	6,6	6,3	6	5,7	5,3	5,1	4,8							t
	2,4 → 28,3	51,2 - 52,4	12	12	11,2	10,4	9,4	8,8	8,1	7,6	7	6,7	6,2	6	5,7	5,4	5,1							t P+
55	2,4 → 27,6	50 - 51,1	12	12	10,9	10,1	9,1	8,6	7,8	7,4	6,8	6,5	6	5,9	5,5									t
	2,4 → 29,2	53 - 54,2	12	12	11,7	10,8	9,8	9,2	8,4	7,9	7,3	6,9	6,4	6,1	5,9									t P+
50	2,4 → 28,9		12	12	11,5	10,7	9,7	9,1	8,3	7,8	7,2	6,9	6,4											t
	2,4 → 30,2		12	12	12	11,2	10,2	9,5	8,7	8,2	7,6	7,2	6,7											t P+
45	2,4 → 29,6		12	12	11,8	11	9,9	9,3	8,5	8	7,4													t
	2,4 → 31		12	12	12	11,5	10,4	9,8	8,9	8,5	7,8													t P+
40	2,4 → 30		12	12	12	11,1	10	9,4	8,6															t
	2,4 → 31,4		12	12	12	11,7	10,6	10	9,1															t P+
35	2,4 → 29,8		12	12	11,9	11,1	10																	t
	2,4 → 31,1		12	12	12	11,6	10,5																	t P+
30	2,4 → 30		12	12	12																			t
	2,4 → 30		12	12	12																			t P+

$↕ = ↕ - 0,17 \text{ t max.}$

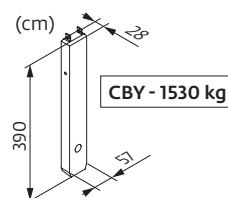
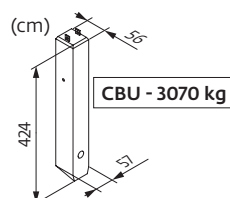
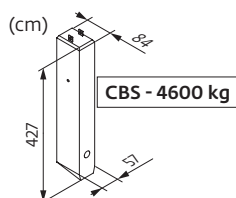

Poids de flèche & lest de contre-flèche / Auslegergewicht & Gegenauslegerballast / Jib weight & counter-jib ballast / Peso de flecha y lastre de contra-flecha/Peso del braccio & zavorra di contro-braccio/Peso da lança & lastro da contra lança/Вес стрелы и балласт контр-стрелы

↕	↕ (kg) (+/- 5%)			↕		↕		↕	
	↕ ↕	↕	↕ ↕ ↕	4600 kg	1530 kg	↕ (kg)	3070 kg	1530 kg	↕ (kg)
75 m	18070	17675	18140	5	2	26060	8	1	26090
70 m	17805	17425	17865	5	2	26060	8	1	26090
65 m	17420	17065	17510	5	2	26060	8	1	26090
60 m	16495	16170	16565	5	1	24530	8	0	24560
55 m	16505	16185	16575	5	1	24530	8	0	24560
50 m	15690	15370	15765	5	2	26060	8	1	26090
45 m	15430	15105	15500	5	2	26060	8	1	26090
40 m	14615	14295	14685	5	0	23000	7	1	23020
35 m	14085	13765	14155	4	2	21460	7	0	21490
30 m	13245	12925	13320	4	1	19930	6	1	19950











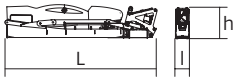
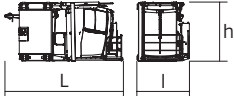
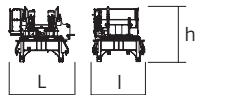

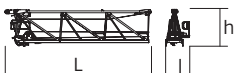
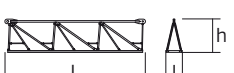
Encombremet et poids / Abmessungen und Gewicht / Dimensions and weight / Dimensiones y peso / Ingombro e peso  
dimensões e pesos / габаритные размеры и вес

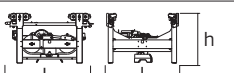
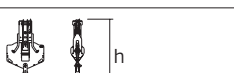
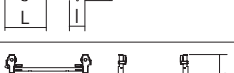
Partie tournante / Drehender Kranteil / Slewing crane part / Parte giratoria

Parte rotante / Parte rotativa / Поворотная часть :  75 m -  12 t -  75 HPL™

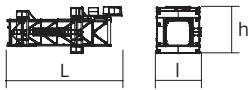

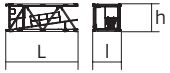
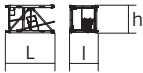
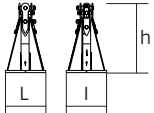
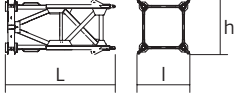
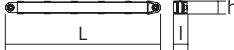
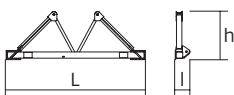
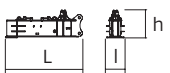
Partie tournante / Drehender Kranteil / Slewing crane part Parte giratoria / Parte rotante / Parte rotativa Поворотная часть		L (m)	l (m)	h (m)	kg (+/- 5%)
Contre-flèche / Gegenausleger Counter-jib / Contra-flecha Controbraccio / Contra-lança Контр-стрела		12 12 12	1,25 1,25 1,25	2,5 2,5 2,5	14110 13600 11540
Mât-cabine + cabine / Kabinenmast + Kabine Cab mast + cab / Mástil-cabina + cabina Portaralla superiore + cabina / Tramo-cabina + cabina Секция мачты кабины + кабина		5,03	2,22	2,49	6720
Pivot / Krankopf Towerhead / Pivote Portaralla / Pivot Секция поворотной части		2,95	2,48	2,5	7620
Treuil de levage (+ câble) / Hubwerk (+ Seil) Hoisting winch (+ rope) / Mecanismo de elevación (+ cabo) Argano di sollevamento (+ fune) Guincho de elevação (+ cabo) Подъемная лебедка (+ канатом)		4,27	2,3	2,32	4500
Elément de flèche / Auslegerelement Jib section / Elemento de flecha Elemento di braccio / Elemento de lança Секция стрелы		10,75	1,8	2,74	5450
Elément de flèche / Auslegerelement Jib section / Elemento de flecha Elemento di braccio / Elemento de lança Секция стрелы		10,21 10,31 10,22 10,24 10,19	1,2 1,2 1,2 1,2 1,2	2,5 2,42 2,39 2,1 1,83	3145 2420 1560 1235 950
Elément de flèche / Auslegerelement Jib section / Elemento de flecha Elemento di braccio / Elemento de lança Секция стрелы		5,27 5,09 5,09	1,2 1,2 1,2	2,39 1,53 1,39	960 310 220
Chariot / Laufkatze Trolley / Carrello Carro / Carro-distribuidor Тележка		1,87	1,51	1,05	400
Moufle / Hubflasche Pulley block / Aparejo Bozzello / Cadernal Полиспаст		1,19	0,43	2,31	455
Chariot / Laufkatze Trolley / Carrello Carro / Carro-distribuidor Тележка		1,57	1,51	0,98	210
Chariot / Laufkatze Trolley / Carrello Carro / Carro-distribuidor тележка		1,7 1,86	1,51 1,51	1,03 0,98	245 236
Moufle / Hubflasche Pulley block / Aparejo Bozzello / Cadernal Полиспаст		1,65 1,09	0,22 0,27	1,78 1,62	450 265

Рүлбне / Kranturm / Crane tower Mástil / Torre / Torre Башня крана		L (m)	l (m)	h (m)	kg (+/- 5%)
T 61		10,83	4,14	4,47	9700
K 649B KM 649E KRM 6410B		10,23 10,29 10,23	2,07 2,03 2,1	2,03 2,03 2,08	5290 4850 7100
K 649A KMT 649A KR 649A KRMT 649A		5,23 5,23 5,23 5,23	2,07 2,07 2,1 2,1	2,03 2,03 2,08 2,08	2805 2570 3250 3050
K 649C KMT 649C KRMT 649C		3,57 3,57 3,57	2,07 2,07 2,1	2,03 2,03 2,08	2070 2060 2450
Pieds de scellement / Verankerungsfüße Fixing angles / Pie de empotramiento Montante da annegare / Angulos fixadores анкера				1,28	465
Mât-châssis / Grundmasteinheit Basic mast unit / Tramo-chasis Elemento base / Tramo-chassis Мачта для крепления к шасси		5,01 10,02	2,41 2,41	2,41 2,41	4760 7660
Haubans / Mastabstützungen / Struts / Tornapuntas Puntoni / Escoras / Растяжка		4,51 4,51	0,29 0,33	0,29 0,33	470 560
Sommier / Unterwagenhälfte Half-bearer / Testero Testata / Estrutura base Траверса		6,7 6,7	0,7 0,7	2,31 2,31	1840 1860
1/2 Bras de croix / 1/2 Fundamentkruzträger 1/2 Cross girder / 1/2 Braço en cruz 1/2 Braccio croce / 1/2 Braço da cruz 1/2 Поперечная балка		4,35	1	1,56	3320
Bras de croix / Fundamentkruzträger Cross girder / Braço en cruz / Braccio croce / Braço da cruz Поперечная балка		9,15	1,19	1,56	6880

Mécanismes / Triebwerke / Mechanisms / Mecanismos / Meccanismi  
 Mecanismos / Механизмы

400 V - 50 Hz													ch - PS hp	kW	
	<b>75 HPL™ 30</b>	m/min t	44 6	57,5 4,5	82 3	140 1,5	220,5 0,2	23 12	30 9	43,5 6	74 3	110 0,8	75	55	845 m
	<b>6 DVF 6 Optima</b>	m/min	0 → 42 (12 t) 0 → 84 (8 t) 0 → 100 (4 t)									5,5	4		
	<b>RVF 172 Optima+</b>	tr/min U/min rpm	0 → 0,8									2 x 10	2 x 7,5		

	<b>IEC 60204-32</b>		
	400 V (+10% -10%) 50 Hz	75 HPL™ : 84 → 54 kVA	

	<b>FR</b>	<b>DE</b>	<b>EN</b>	<b>ES</b>	<b>IT</b>	<b>PT</b>	<b>RU</b>
	Profil de vent suivant EN 14439 C50-D50	Windbedingungen gemäss EN 14439 C50-D50	Wind conditions according to EN 14439 C50-D50	Conformidad de los condiciones de viento EN 14439 C50-D50	Condizioni del vento secondo EN 14439 C50-D50	Perfil de vento conforme EN 14439 C50-D50	Ветровой режим в соответствии с EN 14439 C50-D50
	Appel de flèche	Auslegerüberhöhung	Jib elevation	Elevación de la flecha	Inclinazione braccio	Desvio da lança	подъем стрелы
	Équipements standards	Standardausrüstungen	Standard equipment	Equipamiento de serie	Equipaggiamento standard	Equipamento de série	Стандартное оборудование
	Équipements optionnels	Sonderausrüstungen	Options	Equipamiento opcional	Equipaggiamento in opzione	Equipamento opcional	Дополнительное оборудование (опция)
	Fonction Potain Plus : Courbes de charges Plus	Funktion Potain Plus: Plus-Lastkurven	Potain Plus function: Plus load curves	Función Potain Plus: Diagrama de cargas Plus	Funzione Potain Plus: Curve di carico Plus	Função Potain Plus: Diagrama de cargas Plus	Функция контроля мощности Potain Plus: Диаграммы грузоподъемности Plus
	Hauteurs sous crochet associées aux courbes de charges Plus	Hakenhöhen mit Plus-Lastkurven	Hook heights with Plus load curves	Altura bajo gancho, usando el diagrama de cargas Plus	Altezze sotto gancio con curve di carico Plus	Altura livre, utilizando o diagrama de cargas Plus	Высота под крюком для диаграмм грузоподъемности Plus
	Réactions en service	Reaktionskräfte in Betrieb	Reactions in service	Reacciones en servicio	Reazioni in servizio	Reacções em serviço	Реакция при работе
	Réactions hors service	Reaktionskräfte außer Betrieb	Reactions out of service	Reacciones fuera de servicio	Reazioni fuori servizio	Reacções fora de serviço	Реакция в покое
	Poids total du lest	Ballast-Gesamtgewicht	Total ballast weight	Peso total del lastre	Peso totale della zavorra	Peso total do lastro	Общий вес балласта
	Poids de flèche	Auslegergewicht	Jib weight	Peso de flecha	Peso del braccio	Peso da lança	вес стрелы
	Camion 13,4 m	Lkw 13,4 m	Lorry 13,4 m	Camión 13,4 m	Camion 13,4 m	Camião 13,4 m	Ррузовой автомобиль 13,4 м
	Conteneur High Cube 40', et/ou Flat Rack 20'	Container High Cube 40', und/oder Flat Rack 20'	Container High Cube 40', and/or Flat Rack 20'	Contenedor High Cube 40', y/o Flat Rack 20'	Container High Cube 40', e/o Flat Rack 20'	Contentor High Cube 40', e/ou Flat Rack 20'	40-футовый контейнер повышенной вместимости High Cube, и/или 20-футовая открытая платформа Flat Rack
	Levage	Heben	Hoisting	Elevación	Sollevamento	Elevação	Подъем
	Distribution	Katzfahren	Trolleying	Distribución	Ditribuzione	Distribuição	Перемещение по стреле
	Orientation	Schwenken	Slewing	Orientación	Rotazione	Rotação	Поворот
	Translation	Kranfahren	Travelling	Traslación	Traslazione	Translação	Перемещение крана
	Puissance requise	Erforderliche Leistung	Required power	Potencia Necesaria	Potenza richiesta	Potência Necessária	Потребляемая мощность
	Fonction Power Control : vitesses treuils adaptées à la puissance disponible	Funktion Power Control: Geschwindigkeiten der Triebwerke werden an die verfügbare Leistung angepasst	Power Control Function: winch speeds adapted to the available power	Función Power Control: marchas de los cabrestantes adaptadas a la potencia disponible	Funzione Power Control: velocità degli argani adattate alla potenza disponibile	Função Power Control: velocidades de guincho adaptadas à potência disponível	Функция контроля мощности Power Control: регулировка скорости лебедок в зависимости от доступной мощности
	Nous consulter	Auf Anfrage	Consult us	Consultarnos	Consultateci	Consultar-nos	Проконсультируйтесь у нас
	Document commercial non contractuel. Pour toute information technique se référer à la notice correspondante.	Unverbindliches Vertriebsdokument. Für technische Informationen, siehe die entsprechenden Anweisungen.	This commercial document is not legally binding. For any technical information, please refer to the corresponding instructions.	Documento comercial no contractual. Para cualquier información técnica, ver la noticia correspondiente.	Documento commerciale non vincolante, per tutte le informazioni tecniche fare riferimento al catalogo istruzioni.	Documento comercial não contratual. Para qualquer informação técnica complementar consultar as respectivas instruções.	Этот коммерческий документ не является юридически обязательным. Для получения технической информации, см. соответствующие инструкции.

