

Manitowoc 12000-1

Product Guide

ASME B30.5

Metric / Imperial



Features

- 110 t (120 USt) capacity
- 70,1 m (230 ft) heavy-lift boom
- Max boom + jib combination:
61 m (200 ft) + 21,3 m (70 ft)
- 213 kW (285 HP) engine
- 163 m/min (525 fpm) maximum line speed
- 110 kN (25,000 lb) rated line pull

Features

Energy saving systems

Green-Engine mode conserves fuel during full speed drum operation under load, at a lower engine RPM. Other available options include Green-Winch Mode and Auto Idling Stop Mode.



Self-erecting counterweight

Eliminates the need for an assist crane, and also allows for reduced counterweight chart operation.



Retractable crawlers

Crawlers can be extended and retracted for better jobsite maneuverability. On some models, these crawlers can also ship attached for easier transport and quicker setup.



Contents

Specifications	4
Outline dimensions	7
Performance data	12
Load chart notes	13
Boom combinations	14
Main boom range / load charts	16
Fixed jib range / load charts	18
Clamshell	21
Manitowoc Crane Care	22

Specifications

Upperworks



Engine

HINO J08E-UV, 6 cylinder, water-cooled diesel, direct fuel injection with turbocharger, 213 kW (285 HP) at 2100 high-idle RPM. Maximum torque 1017 N•m (750 lb•ft) net at 1,600 rpm; Interim Tier 4/Stage IIIB (Required for sale in the US/Canada/Europe; requires "Ultra Low Sulfur Diesel")

HINO J08E-VM, 6 cylinder, water-cooled diesel, direct fuel injection with turbocharger, 213 kW (285 HP) at 2100 high-idle RPM. Maximum torque 1017 N•m (750 lb•ft) net at 1,600 rpm; Tier 3 (Required for sale outside the US/Canada/Europe)

One diesel fuel tank, 400 liters (105 gallons) capacity.

Two 12 volt 136 AH capacity batteries, 24 volt system and 90 amp alternator.

All wiring harnesses and connectors are numbered for easier servicing. Machine is equipped with individual fused branch circuits.



Controls

Full-flow hydraulic control system for constant variable pressure to front and rear drums, boom hoist brakes and clutches. Controls respond instantly to the touch, delivering smooth function operation.

Relief valve pressures:

Load hoist, boom hoist

and propel system 31.9 MPa (4,630 psi)

Swing system 27.5 MPa, (3,989psi)

Control system 5.4 MPa (783 psi)



Hydraulic system

All four variable displacement piston-type pumps are driven by a heavy-duty pump drive. One of these pumps is used in the right propel circuit and hook hoist circuit and can accommodate an optional third drum circuit. Another is used in the left propel circuit and hook hoist circuit. A third pump is used in the boom hoist circuit. The fourth variable displacement pump is used in the swing circuit. In addition, two gear pumps are used in the control system and auxiliary equipment, and two gear pumps serve the brake cooling system.

Maximum pressure rating 31.9 MPa (4,630 psi)

Load hoist and propel 2 Piston pumps

Boom hoist 1 Piston pump

Swing 1 Piston pump

Control system and auxiliary 2 Gear pumps

Brake cooling system 2 Gear pumps

Hydraulic tank 535 liter (141 US gallon)

Cooling: Oil-to-air heat exchanger (plate-fin type).

Filtration: Full-flow and bypass type with replaceable paper element.



Drums

Front and rear drums for load hoist powered by variable displacement piston-type motors, driven through planetary reducers. Powered hoisting/lowering and free-fall operation is standard. Drum turn indicators for front and rear drums are also standard.

Brake & Clutches (compatible): Forced-circulation oil-cooled wet-type multi-disc brakes, each using positive and negative actuation. An external ratchet is fitted for locking the drums.

Drums: (front and rear) 614 mm (24.2") P.C.D. x 617 mm (24.3") wide drums, grooved for 26.0 mm wire rope.

Wire rope capacity:

Front drum 260 m (853 ft) working length

Rear drum 230 m (754 ft) working length

Line speed: Single line on the first drum layer

Hoisting: 120m/min (390 ft/min)

Lowering: 120m/min (390 ft/min)

Optional third drum: free-fall is optional; drum grooved for 26 mm wire rope. Wire rope capacity working length is 190 m (623').



Swing system

Swing unit: Powered by a hydraulic piston-type motor driving spur gears through planetary reducers, the swing system provides 360° rotation.

Swing brake: A spring-set, hydraulically released multiple-disc brake is internally fitted in swing motor.

Swing lock: 4-position lock for transportation.

Specifications

Rotating bed turntable: Single-row ball bearing with an integral internally cut swing gear.

Swing speed: 3.2 rpm



Boom support system

Single drum powered by a hydraulic axial piston motor through a planetary reducer.

Brake: A spring-set, hydraulically released multiple-disc brake is mounted on the boom hoist motor. An external ratchet is fitted for locking the drum.

Drum: Single drum, grooved for 20 mm diameter wire rope. Boom Hoist reeving is 10-part line.

Wire Rope Capacity:
Drum 155 m (508 ft) working length.

Line speed: Single line on the first drum layer
Hoisting: 48m/min (157 ft/min)
Lowering: 48m/min (157 ft/min)



Gantry

This high folding type gantry is fitted with a sheave frame for boom hoist reeving. It provides full up, full down positions. Hydraulic lift is standard.



Counterweight

Upper weight (5 pieces): 76,280 lb (34,600 kg)
Carbody weight (2 pieces): 14,330 lb (6,500 kg)



Operator's cab

Totally enclosed, full vision cab fitted with tinted safety glass. A fully adjustable, highbacked seat with arm rests permits operators to set their ideal working position. Short handle control levers; electronic twist grip hand throttle. Joystick controls are optional. An air conditioner, a signal horn and windshield wiper are standard features.

Controls

Full-flow hydraulic control system for constant variable pressure to front and rear drums, boom hoist brakes and clutches. Controls respond instantly to the touch, delivering smooth function operation.

Safety device

New easy to read at a glance LMI and maintenance display. Function lock lever, anti-two-block, boom over hoist limit switch, boom angle indicator, signal horn, boom hoist drum lock, front and rear drum lock, swing lock, swing alarm (buzzer and lamps), boom backstops and load moment indicator.

Lights: 2 - Front flood lights
1 - Cab inside light

Lowerworks



Carbody

The durable carbody features steel welded construction with extendible axles.



Crawlers

Crawler assemblies can be hydraulically extended for wide-track operation. Crawler belt tension adjusted with hydraulic jack and maintained by shims between idler block and frame.

Crawler drive

The independent hydraulic propel drive is built into each crawler side frame. Each drive consists of a hydraulic motor driving a propel sprocket through a planetary gearbox. The hydraulic motor and gearbox are built into the crawler side frame within the shoe width. The track rollers are sealed for maintenance-free operation.

Crawler brakes

Spring set, hydraulically released, multiple disc-type parking brakes are built into each propel drive.

Steering mechanism

The hydraulic propel system provides both skid steering (driving one track only) and counter-rotating steering (driving each track in opposite direction) and differential track speed.

Crawler shoes

914 mm (36") wide each crawler.

Travel speed

(High/Low) 1.4/1.0 km/h (0.87/0.62 mph)

Specifications

Attachments



Boom

Welded lattice construction using tubular, high-tensile steel chords with pin connections between sections. Boom tip is open throat construction. Two idler sheaves and four point sheaves are standard.

Basic boom length 15,2 m (50') consists of the boom butt section 7,62 m (25' 0") and boom top section 7,62 m (25' 0").

Optional boom inserts are available to provide extension capabilities. They also have welded lattice construction with tubular, high-tensile steel chords and pin connections on each one of 3,0 m (10'), 6,1 m (20'), 12,2 m (40') inserts.

Maximum total length of boom 70,1 m (230').



Fixed jib

The optional fixed jib employs welded lattice construction with tubular, high-tensile steel chords with pin connections between sections.

Basic jib length 9,14 m (30') consists of jib butt section 4,57 m (15') and jib top section 4,57 m (15').

Optional jib boom inserts of 3,0 m (10'), 6,1 m (20') are available for extension capabilities up to 21,3 m (70').

Maximum total length of boom and jib 61,0 m (200') + 21,3 m (70') is 82,3 m (270').

Tools and accessories

A set of tools and accessories are furnished.

Optional equipment

- Optional: Blocks and Hooks each with roller bearing sheaves grooved for 26.0 mm diameter wire rope, and roller bearing swivel with hook latch.
- 13,5 t ball hook, 450 kg, wedge socket for 26 mm wire rope. (15 USt ball hook, 1,310 lb wedge socket for 26 mm wire rope.)
- 35 t hook block, 700 kg with one 500 mm Nominal O.D. roller bearing sheaves. (40 USt hook block, 1,881 lb with one 24" Nominal O.D. roller bearing sheaves.)

- 70 t hook block, 900 kg, with three 500 mm Nominal O.D. roller bearing sheaves. (90 USt hook block, 4,060 lb, with three 24" Nominal O.D. roller bearing sheaves.)
- 110 t hook block, 1700 kg, with five 500 mm Nominal O.D. roller bearing sheaves. (120 USt hook block, 3,760 lb with five 24" Nominal O.D. roller bearing sheaves.)
- Optional: Detachable upper boom point with one 575 mm Nominal outer diameter roller bearing steel sheave grooved for 26mm rope for liftcrane.
- Machine inclination sensor.
- Swing angle detection and angle limiter.
- Hydraulic tagline.
- External lamp for overload alarm.

Working weight

Approximately 99,900 kg (220,300 lb) including upperworks and lowerworks, full upper counterweights, full carbody counterweight and 15,2 m (50') basic boom.

Ground pressure

Approximately 93.9 kPa (13.6 psi) with basic boom and no load.

Gradeability

With basic boom: 40%.

Outline dimensions

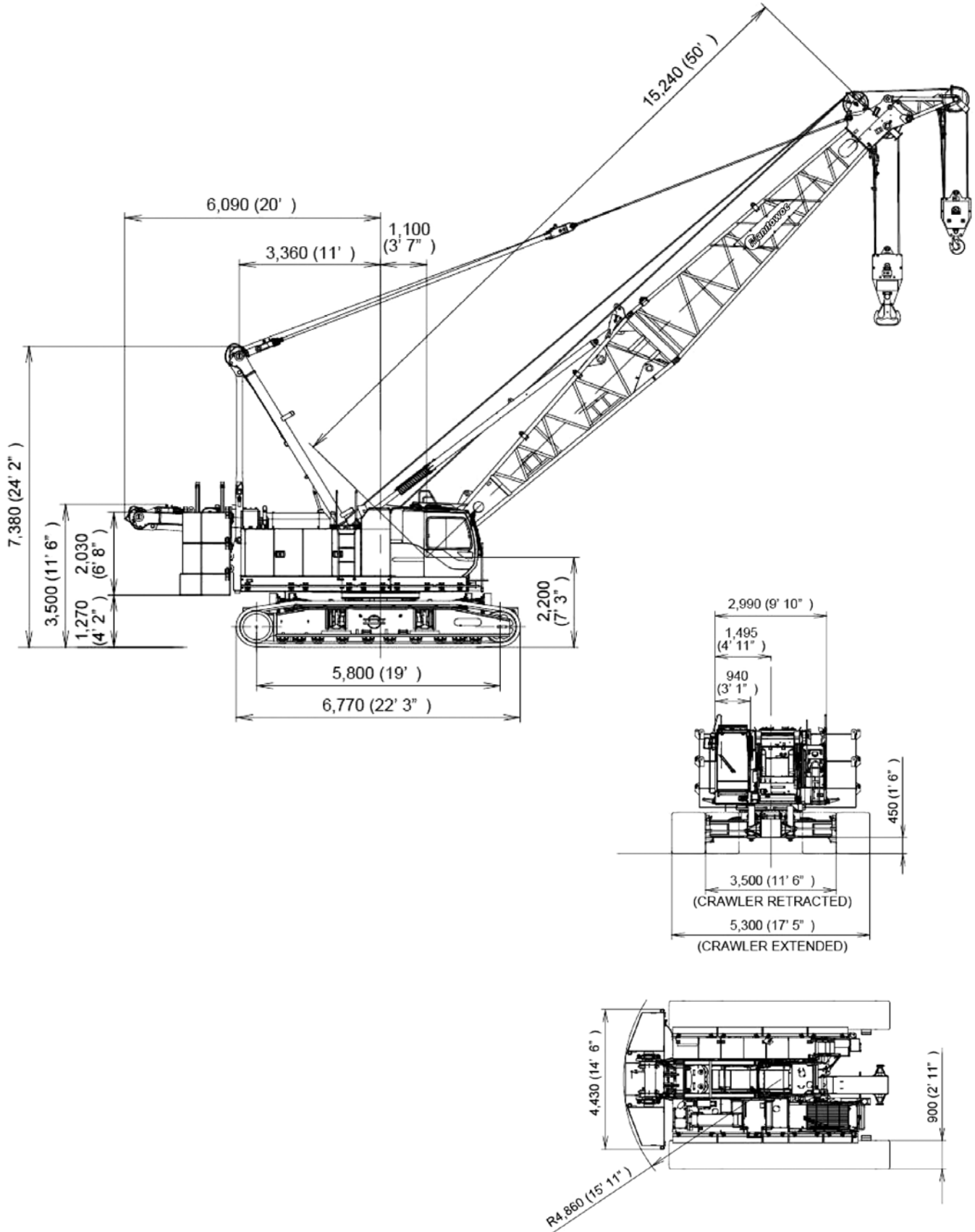

Outline dimensions

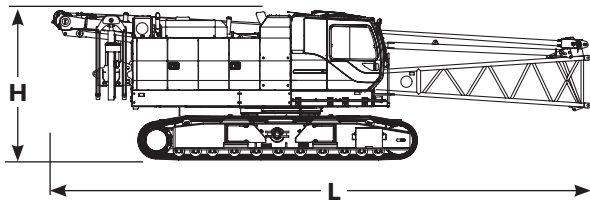

Upperworks x 1

Length	15,78 m	51' 9"
Width	3,50 m	11' 8"
Height	3,50 m	11' 6"
Weight	57 520 kg	126,808 lb

Note: Weight includes base machine, crawler, gantry, maximum hoist and whip lines on drums, boom butt, full hydraulic fluid reservoir, and one third tank of fuel.

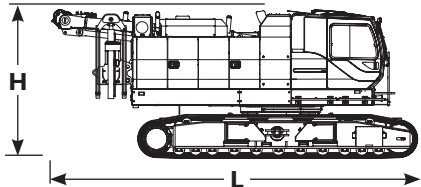

Upperworks x 1

Length	9,42 m	30' 11"
Width	3,50 m	11' 6"
Height	3,50 m	11' 6"
Weight	54 200 kg	119,808 lb

Note: Weight includes base machine, crawler, gantry, maximum hoist and whip lines on drums, full hydraulic fluid reservoir, and one third tank of fuel.

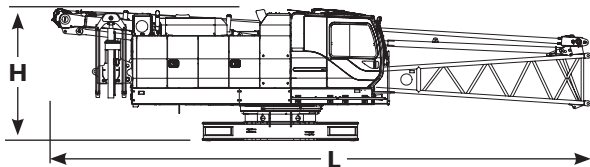

Upperworks without crawlers x 1

Length	15,78 m	51' 9"
Width	2,99 m	9' 10"
Height	3,05 m	10' 0"
Weight	33 660 kg	74,206 lb

Note: Weight includes base machine, gantry, maximum hoist and whip lines on drums, full hydraulic fluid reservoir, and one third tank of fuel.

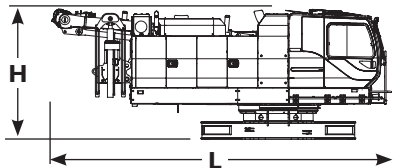

Upperworks without crawlers x 1

Length	8,65 m	28' 5"
Width	2,99 m	9' 10"
Height	3,05 m	10' 0"
Weight	30 340 kg	66,887 lb

Note: Weight includes base machine, gantry, maximum hoist and whip lines on drums, full hydraulic fluid reservoir, and one third tank of fuel.

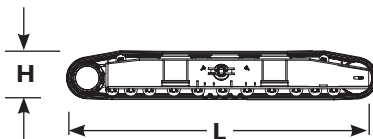

Crawlers x 2

Length	6,77 m	22' 2"
Width	0,90 m	2' 11"
Height	1,13 m	3' 9"
Weight	11 930 kg	26,301 lb

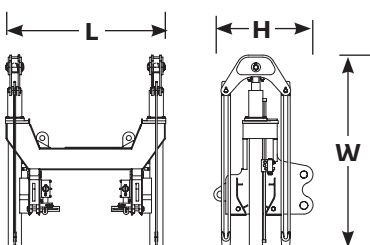

Self removal unit x 1

Length	1,59 m	5' 3"
Width	1,90 m	6' 3"
Height	0,98 m	3' 3"
Weight	870 kg	1,918 lb

Option

Outline dimensions

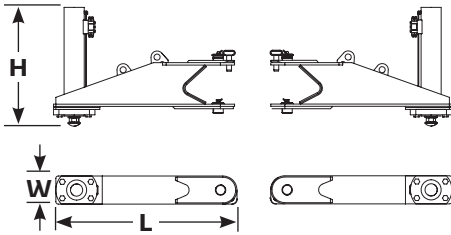

Hydraulic jack (if removed)		x 1
Length	1,48 m	4' 10"
Width	0,23 m	0' 9"
Height	0,97 m	3' 2"
Weight	320 kg	705 lb

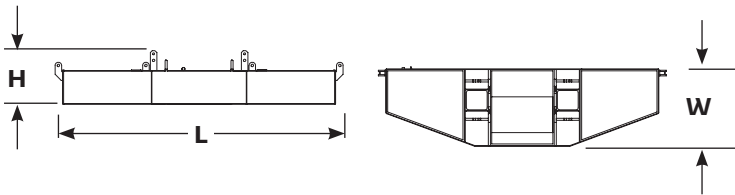

Upper counterweight A		x 1
Length	4,43 m	14' 6"
Width	1,19 m	3' 11"
Height	0,83 m	2' 9"
Weight	11 600 kg	25,573 lb

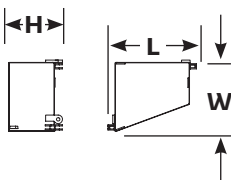

Upper counterweight B		x 2
Length	1,45 m	4' 9"
Width	1,17 m	3' 10"
Height	0,88 m	2' 11"
Weight	5 750 kg	12,676 lb

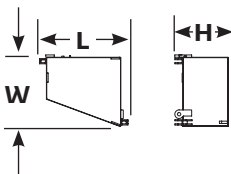

Upper counterweight C		x 2
Length	1,45 m	4' 9"
Width	1,17 m	3' 10"
Height	0,88 m	2' 11"
Weight	5 750 kg	12,676 lb

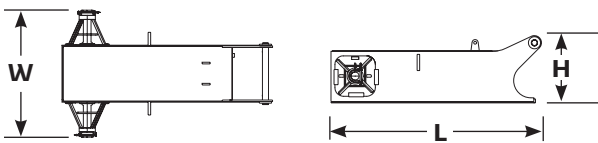

Carbody counterweight with float		x 1
Length	2,08 m	6' 10"
Width	1,26 m	4' 2"
Height	0,66 m	2' 2"
Weight	3 320 kg	7,319 lb

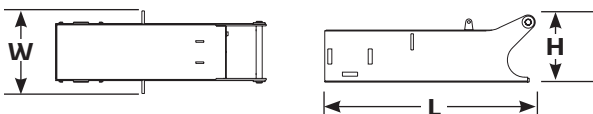

Carbody counterweight without float		x 1
Length	2,08 m	6' 10"
Width	0,82 m	2' 8"
Height	0,66 m	2' 2"
Weight	3 250 kg	7,165 lb

Option

Outline dimensions

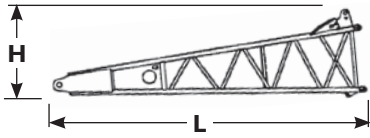

Boom butt 7,6 m (25 ft)		x 1
Length	7,79 m	25' 7"
Width	1,73 m	5' 8"
Height	2,06 m	6' 9"
Weight	2 235 kg	4,927 lb

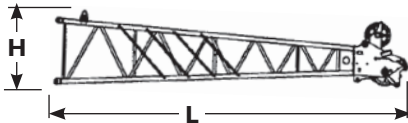

Boom top 7,6 m (25 ft)		x 1
Length	8,32 m	27' 4"
Width	1,68 m	5' 6"
Height	1,65 m	5' 5"
Weight	1 525 kg	3,360 lb

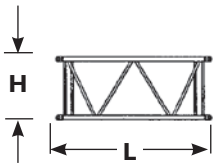

Boom insert 3,0 m (10 ft)		x 1,2
Length	3,16 m	10' 4"
Width	1,68 m	5' 6"
Height	1,69 m	5' 7"
Weight	380 kg	840 lb

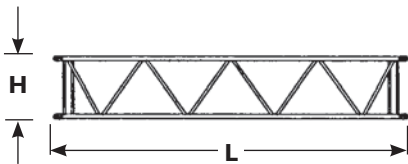

Boom insert 6,1 m (20 ft)		x 1,2
Length	6,21 m	20' 5"
Width	1,68 m	5' 6"
Height	1,69 m	5' 7"
Weight	655 kg	1,445 lb

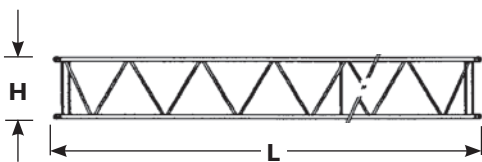

Boom insert 12,2 m (40 ft)		x 1,2,3
Length	12,31 m	40' 4"
Width	1,68 m	5' 6"
Height	1,69 m	5' 7"
Weight	1 195 kg	2,635 lb

Note: Use of one "A" type insert with lug required for any boom combinations that require a 12,2 m (40') insert.

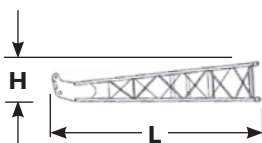

Fixed jib butt		x 1
Length	4,81 m	15' 9"
Width	0,80 m	2' 8"
Height	0,80 m	2' 8"
Weight	200 kg	440 lb

Option

Outline dimensions

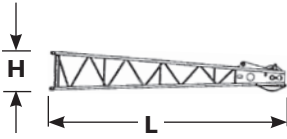

Fixed jib top		x 1
Length	5,00 m	16' 5"
Width	0,80 m	2' 8"
Height	0,80 m	2' 8"
Weight	280 kg	620 lb

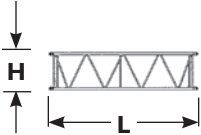

Fixed jib insert 3,0 m (10 ft)		x 1,2
Length	3,11 m	10' 2"
Width	0,80 m	2' 8"
Height	0,80 m	2' 8"
Weight	100 kg	220 lb

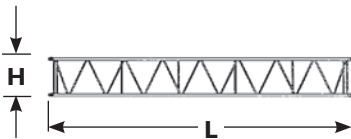

Fixed jib insert 6,1 (20 ft)		x 1,2
Length	6,16 m	20' 3"
Width	0,80 m	2' 8"
Height	0,80 m	2' 8"
Weight	180 kg	400 lb

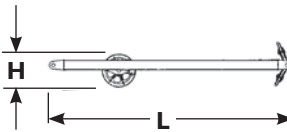

Fixed jib strut		x 1
Length	3,62 m	11' 11"
Width	0,84 m	2' 9"
Height	0,62 m	2' 1"
Weight	250 kg	550 lb

 Option

Performance data

Line pull		
	Rated line pull kg (lb)	*Maximum line pull kg (lb)
Front drum	11 400 (25,100)	21 200 (46,800)
Rear drum	11 400 (25,100)	21 200 (46,800)
Optional 3rd drum	11 400 (25,100)	21 200 (46,800)

* Maximum line pull is not based on wire rope strength.

Wire rope specifications				
Use	Specs	Diameter mm	Working length m (ft)	Breaking strength kg (lb)
Front drum	IWRC 6 X Fi (29) C/O	26,0	260 (853)	54 431 (120,000)
Rear drum	IWRC 6 X Fi (29) C/O	26,0	230 (754)	54 431 (120,000)
Boom hoist drum	IWRC 6 X WS (31) C/O	20,0	155 (508)	33 430 (73,700)
Third drum (optional)	IWRC 6 X Fi (29) C/O	26,0	190 (623)	54 431 (120,000)

Front and rear winch performance (optional: third winch)						
Layer	Line speed m/min (ft/min)					
	1	2	3	4	5	6
Single line pull kg (lb)						
0 (0)	120 (394)	129 (422)	137 (450)	146 (479)	155 (505)	163 (535)
2 268 (5,000)	118 (387)	126 (415)	135 (443)	143 (471)	152 (499)	160 (526)
4 536 (10,000)	108 (353)	108 (353)	108 (353)	108 (353)	108 (353)	108 (353)
6 804 (15,000)	72 (235)	72 (235)	72 (235)	72 (235)	72 (235)	72 (235)
9 072 (20,000)	52 (117)	52 (117)	52 (117)	52 (117)	52 (117)	52 (117)
11 340 (25,000)	43 (141)	43 (141)	43 (141)	43 (141)	43 (141)	43 (141)
13 608 (30,000)	36 (118)	36 (118)	36 (119)	37 (121)	37 (122)	37 (123)
15 876 (35,000)	31 (103)	32 (104)	32 (105)	32 (105)	–	–
18 144 (40,000)	28 (92)	28 (92)	–	–	–	–

NOTE: Line speeds and line pull based on single line.
Line pulls are not based on wire rope strength.

Load chart notes

- Rated loads included in the charts are the maximum allowable freely suspended loads at a given boom length, boom angle and load radius, and have been determined for the machine standing level on firm supporting surface under ideal operating conditions. The user must limit or de-rate rated loads to allow for adverse conditions (such as soft or uneven ground, out-of-level conditions, wind, side loads, pendulum action, jerking or sudden stopping of loads, inexperience of personnel, multiple machine lifts, and traveling with a load).
- Capacities do not exceed 75% of minimum tipping loads. Capacities based on factors other than machine stability such as structural competence are shown by asterisk * in the charts located in the operator's crane cab.
- The machine must be reeved and set-up as stated in the operation manual and all the instruction manuals. If these manuals are missing, obtain replacements. Boom backstops are required for all boom lengths. Gantry must be in the fully raised position for all operations. Crawlers must be fully extended and be locked in position. The crane must be leveled to within 1% on a firm supporting surface.
- Do not attempt to lift where no radius or load is listed as crane may tip or collapse.
- Attempting to lift more than rated loads may cause machine to tip or collapse. Do not tip machine to determine capacity.
- Weight of hooks, hook blocks, slings and other lifting devices are a part of the total load. Their total weight must be subtracted from the rated load to obtain the weight that can be lifted.
- When lifting over boom point with jib or upper boom point installed, rated loads for the boom must be deducted as shown below.

Jib length m (ft)	Upper boom point	9,1 (30)	12,2 (40)	15,2 (50)	18,3 (60)	21,3 (70)
Deduct kg (lb)	318 (700)	1100 (2,400)	1500 (3,200)	2000 (4,200)	2400 (5,200)	2900 (6,200)

- The total load that can be lifted by the fixed jib is limited by rated jib loads. The total load that can be lifted with the upper boom point is limited by rated upper boom point loads.
- Boom lengths for fixed jib mounting are 27,4 m (90 ft) to 61,0 m (200 ft).
- An upper boom point cannot be used on a 70,1 m (230 ft) boom length.
- The boom should be erected over the front of the crawlers, not laterally.
- Least stable position is over the side.
- Maximum hoist load for number of reeving parts of line for hoist rope.

Maximum load for main boom

No. of parts of line	1	2	3	4	5
Maximum loads kg (lb)	11 300 (25,000)	22 600 (50,000)	33 900 (75,000)	45 200 (100,000)	56 500 (125,000)

No. of parts of line	6	7	8	9	10
Maximum loads kg (lb)	67 800 (150,000)	79 100 (175,000)	90 400 (200,000)	101 700 (225,000)	110 000 (240,000)

Maximum load for fixed jib

No. of parts of line	1
Maximum loads kg (lb)	10 800 (24,000)

Maximum load for upper boom point (on liftcrane boom)

No. of parts of line	1	2
Maximum loads kg (lb)	11 300 (25,000)	22 600 (50,000)

- Lifting capacities listed apply only to the machine as originally manufactured for and supplied by Manitowoc Cranes, Inc. Modifications to this machine or use of equipment other than that specified can reduce operating capacity.
- Designed and rated to comply with ASME Code B30.5.

Operation of this equipment in excess of rated loads or disregard of instruction voids the warranty.

Boom combinations

No. 12000-1 heavy-lift boom combinations			
Boom length m (ft)	Boom inserts		
	3,1 m (10 ft)	6,1 m (20 ft)	12,2 m (40 ft)
15,2 (50)	–	–	–
18,3 (60)	1	–	–
21,3 (70)	2	1	–
24,4 (80)	1	1	–
27,4 (90)	2	1	–
30,5 (100)	1	2	–
33,5 (110)	2	2	–
36,6 (120)	1	1	1*
39,6 (130)	2	1	1*
42,7 (140)	1	2	1*
45,7 (150)	2	2	1*
48,8 (160)	1	1	2*
51,8 (170)	2	1	2*
54,9 (180)	1	2	2*
57,9 (190)	2	2	2*
61,0 (200)	1	1	3*
64,0 (210)	2	1	3*
67,0 (220)	1	2	3*
70,1 (230)	2	2	3*

* NOTE: One 40 ft (12,2 m) boom insert with lug 40A is required for fixed jib. When no jib is installed a 40 ft (12,2 m) boom can be used instead of 40A.

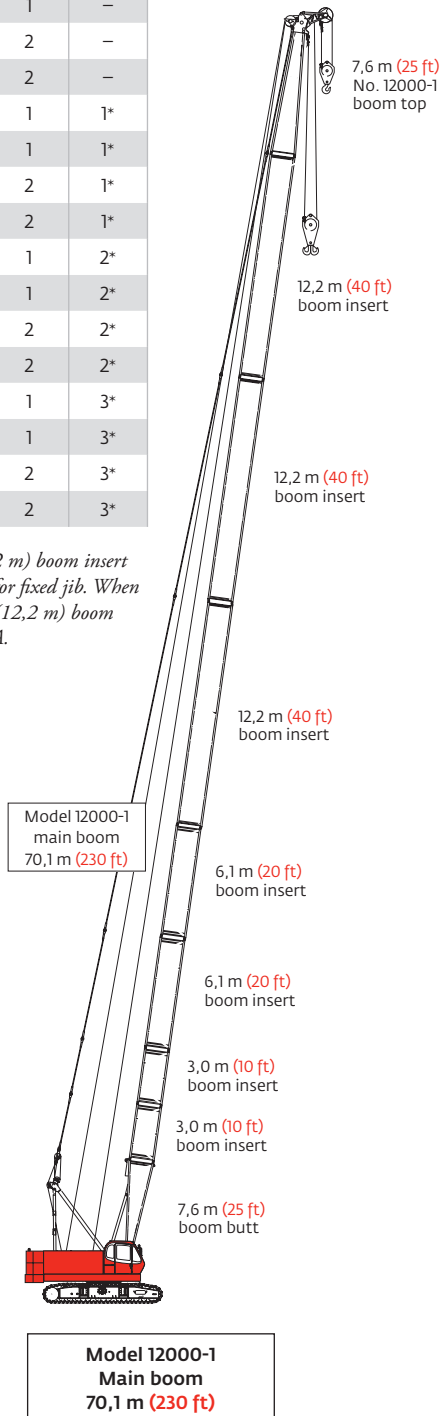

Boom combinations

No. 12000-1 fixed jib combinations

Fixed jib length m (ft)	Fixed jib inserts	
	3,1 m (10 ft)	6,1 m (20 ft)
9,1 (30)	–	–
12,2 (40)	1	–
15,2 (50)	–	1
18,3 (60)	1	1
21,3 (70)	–	2

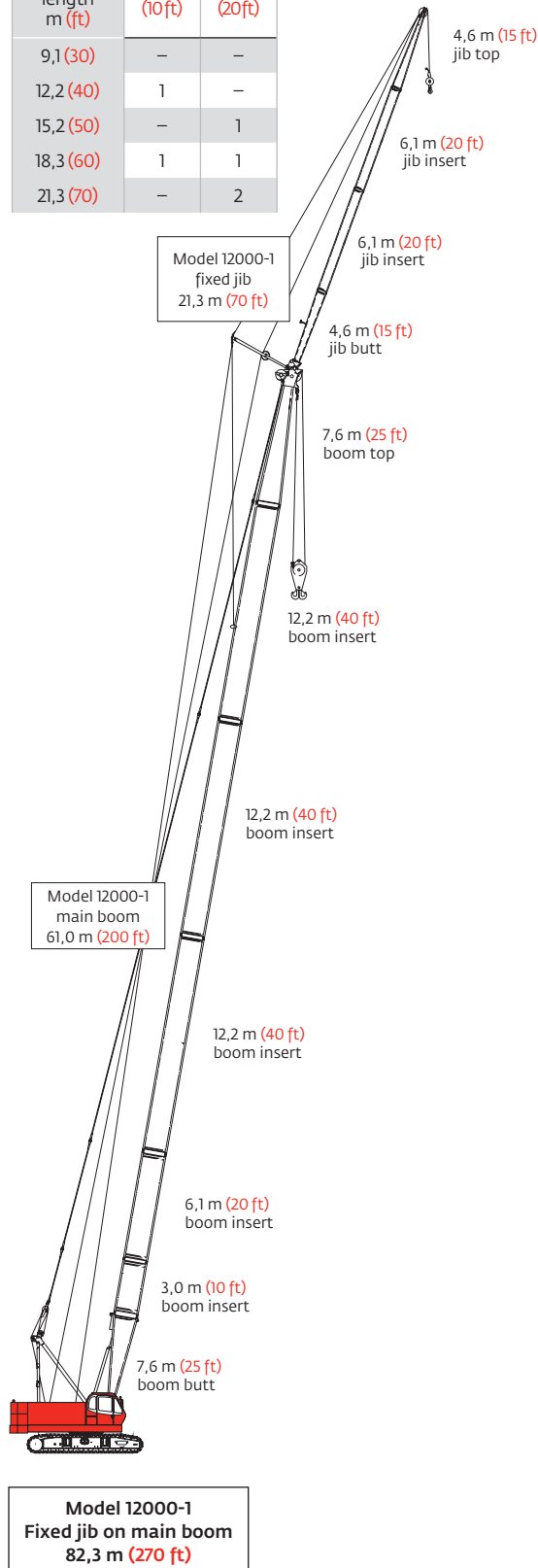

Heavy-lift boom range diagram

No. 12000-1 main boom

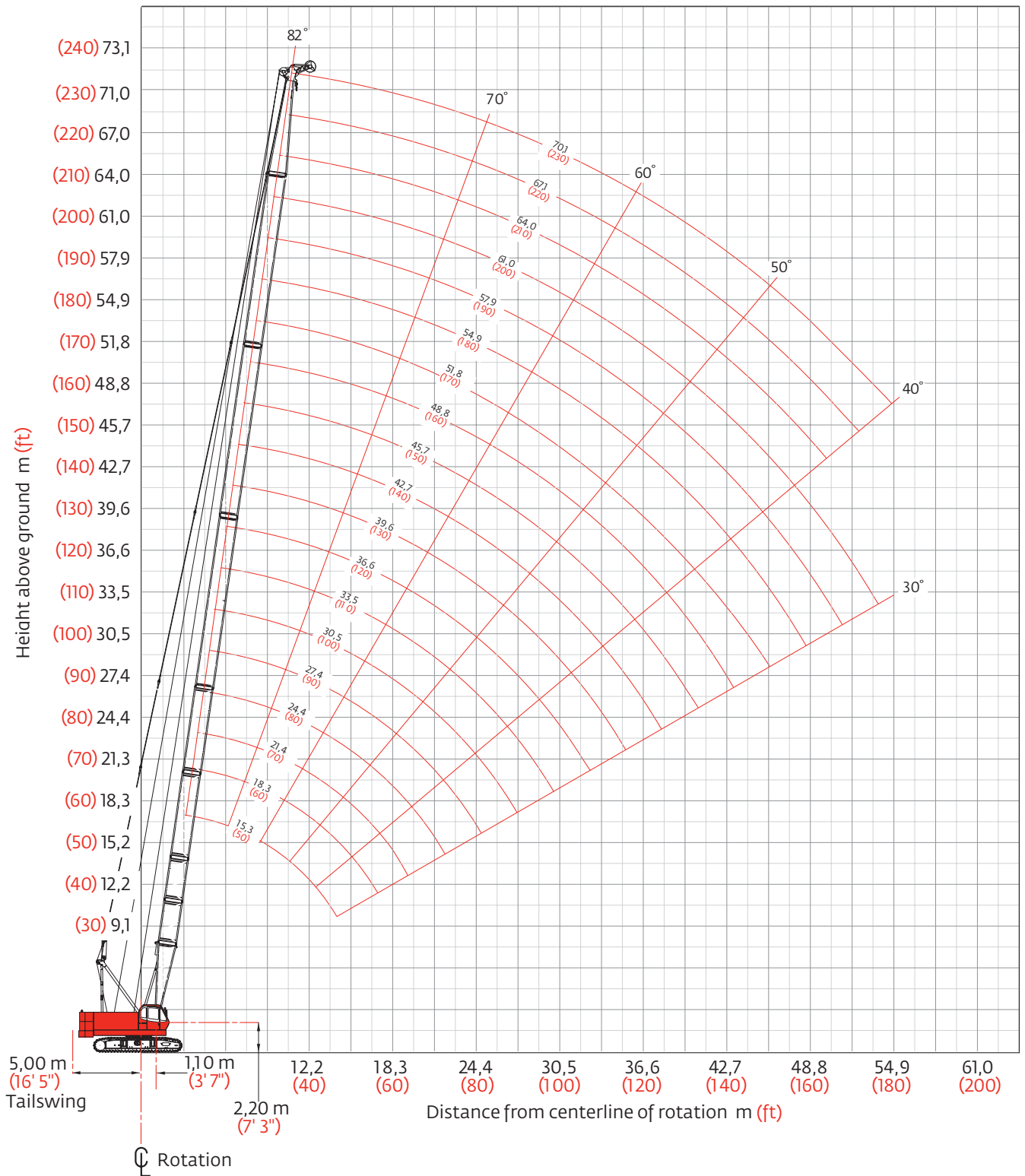

Heavy-lift boom load charts

Model 12000-1 liftcrane boom capacities - 12000-1 main boom

34 600 kg (76,280 lb) crane counterweight, 6 500 kg (14,330 lb) carbody counterweight crawler extended

360° Rating

kg (lb) x 1 000

Boom m (ft)	15,2 (50)	18,3 (60)	21,3 (70)	24,4 (80)	27,4 (90)	30,5 (100)	33,5 (110)	36,6 (120)	39,6 (130)	42,7 (140)	45,7 (150)	48,8 (160)	51,8 (170)	54,9 (180)	57,9 (190)	61,0 (200)	64,0 (210)	67,1 (220)	70,1 (230)	
Radius																				
3,6 (12)	110,0 (240.0)																			
4,0 (14)	99,1 (206.0)	— (204.0)																		
4,5 (16)	88,4 (177.0)	87,6 (177.0)	86,2 (177.0)																	
5,5 (18)	68,0 (150.0)	67,9 (150.0)	67,9 (150.0)	68,0 (150.0)	67,9 (150.0)															
6,0 (20)	62,0 (135.0)	61,9 (135.0)	61,9 (135.0)	62,0 (135.0)	61,9 (135.0)	61,9 (135.0)														
7,0 (24)	53,6 (111.9)	53,6 (111.7)	53,6 (111.7)	53,6 (111.5)	53,6 (111.5)	53,1 (111.3)	53,0 (111.3)	53,3 (111.1)	— (100.0)											
8,0 (28)	44,5 (89.5)	44,3 (89.2)	44,3 (89.0)	44,3 (88.8)	44,3 (88.8)	44,2 (88.6)	44,1 (88.4)	44,1 (88.4)	44,0 (88.1)	43,9 (87.9)	— (87.7)									
10,0 (34)	32,8 (68.3)	32,2 (68.1)	32,2 (67.9)	32,2 (67.4)	32,2 (67.4)	32,1 (67.2)	32,0 (67.0)	32,0 (67.0)	31,9 (66.7)	31,8 (66.5)	31,7 (66.3)	31,6 (66.1)	31,5 (65.9)	30,0 (65.4)						
12,0 (40)	25,6 (55.1)	25,6 (54.6)	25,3 (54.4)	25,3 (54.2)	24,6 (54.0)	24,9 (53.7)	24,8 (53.5)	24,8 (53.5)	24,7 (53.3)	24,6 (53.1)	24,4 (52.6)	24,5 (52.9)	24,3 (52.4)	24,2 (52.2)	24,1 (52.0)	22,6 (50.0)	22,6 (50.0)	21,3 (46.7)	19,5 (42.7)	
14,0 (45)	— (47.1)	20,5 (46.7)	20,5 (46.5)	20,5 (46.2)	20,5 (46.0)	20,3 (45.8)	20,2 (45.6)	20,2 (45.6)	20,1 (45.4)	20,0 (45.1)	19,8 (44.7)	19,9 (44.9)	19,7 (44.5)	19,6 (44.3)	19,5 (44.0)	19,5 (44.0)	19,4 (43.8)	19,2 (43.4)	17,9 (40.1)	
16,0 (55)		17,0 (36.1)	17,0 (35.9)	17,0 (35.4)	17,0 (35.4)	17,0 (35.0)	16,9 (34.8)	16,8 (34.8)	16,8 (34.6)	16,6 (34.3)	16,5 (33.9)	16,5 (33.9)	16,4 (33.7)	16,2 (33.2)	16,1 (33.0)	16,1 (33.0)	16,0 (32.8)	15,9 (32.6)	15,7 (32.1)	
22,0 (75)					11,5 (23.5)	11,0 (23.1)	11,0 (22.9)	10,9 (22.7)	10,8 (22.4)	10,6 (22.2)	10,5 (21.8)	10,5 (21.8)	10,4 (21.6)	10,2 (21.1)	10,0 (20.9)	10,1 (20.9)	10,0 (20.7)	9,8 (20.2)	9,6 (20.0)	
28,0 (95)							7,9 (16.5)	7,8 (16.3)	7,7 (16.0)	7,5 (15.6)	7,4 (15.4)	7,4 (15.4)	7,2 (14.9)	7,0 (14.7)	6,9 (14.3)	6,9 (14.3)	6,8 (14.1)	6,7 (13.8)	6,5 (13.4)	
32,0 (105)								6,4 (14.1)	6,3 (13.8)	6,1 (13.4)	6,0 (13.2)	6,0 (13.2)	5,8 (12.7)	5,6 (12.3)	5,5 (12.1)	5,5 (12.1)	5,4 (11.9)	5,2 (11.4)	5,1 (11.2)	
34,0 (115)									5,8 (12.1)	5,5 (11.6)	5,4 (11.2)	5,4 (11.2)	5,2 (11.0)	5,0 (10.5)	4,9 (10.1)	5,0 (10.3)	4,8 (9.9)	4,6 (9.7)	4,5 (9.2)	
38,0 (125)										4,7 (10.3)	4,5 (9.9)	4,4 (9.7)	4,3 (9.4)	4,1 (9.0)	4,0 (8.8)	4,0 (8.8)	3,8 (8.3)	3,6 (7.9)	3,4 (7.4)	
40,0 (135)												4,1 (8.5)	3,9 (8.1)	3,7 (7.7)	3,5 (7.2)	3,5 (7.2)	3,4 (6.8)	3,2 (6.6)	3,0 (6.1)	
44,0 (145)													3,2 (7.0)	3,0 (6.6)	2,8 (6.1)	2,8 (6.1)	2,6 (5.7)	2,4 (5.2)	2,2 (4.8)	
46,0 (155)														2,7 (5.7)	2,5 (5.2)	2,5 (5.0)	2,3 (4.6)	2,1 (4.4)	1,9 (3.9)	
50,0 (165)															2,0 (4.4)	1,9 (4.1)	1,7 (3.7)	1,6 (3.5)		
53,3 (175)																1,6 (3.5)				

Meets ASME B30.5 Requirements – Capacities do not exceed 75% of static tipping load.
 NOTICE: This capacity chart is for reference only and must not be used for lifting purposes.

For complete chart, refer to www.cranelibrary.com.

Meets ASME B30.5 Requirements - Capacities do not exceed 75% of static tipping load.
 NOTICE: This capacity chart is for reference only and must not be used for lifting purposes.

Fixed jib range diagram

No. 12000-1 fixed jib on main boom

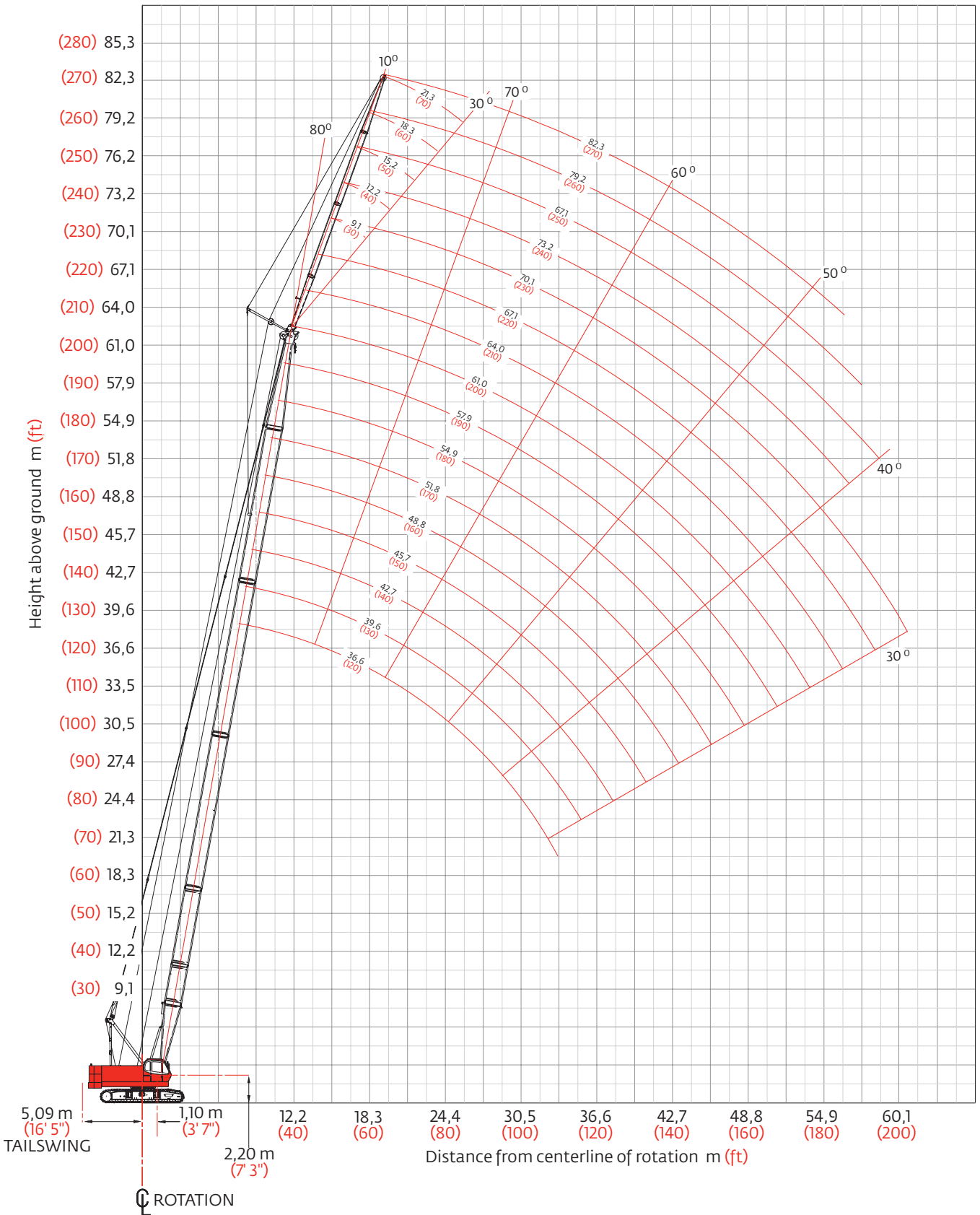

Fixed jib load charts

Model 12000-1 liftcrane fixed jib capacities - No. 12000-1 fixed jib on main boom

34 600 kg (76,280 lb) crane counterweight, 6 500 kg (14,330 lb) carbody counterweight crawler extended
360° Rating kg (lb) x 1 000

		10° offset					30° offset					
		27,4 m (90) ft	36,6 (120)	48,8 (160)	54,9 (180)	61,0 (200)	27,4 (90)	36,6 (120)	48,8 (160)	54,9 (180)	61,0 (200)	
jib 9,1 m (30 ft)	Radius											
	10,0 (30)	10,8 (24.0)					10,0 (30)					
	12,0 (40)	10,8 (24.0)	10,8 (24.0)				12,0 (40)	— (21.0)				
	14,0 (50)	10,8 (24.0)	10,8 (24.0)	10,8 (24.0)	— (24.0)	— (24.0)	14,0 (50)	9,5 (21.0)	9,5 (21.0)			
	18,0 (60)	10,8 (24.0)	10,8 (24.0)	10,8 (24.0)	10,8 (24.0)	10,8 (24.0)	18,0 (60)	9,5 (21.0)	9,5 (21.0)	9,5 (21.0)	9,5 (21.0)	— (21.0)
	24,0 (80)	10,1 (21.9)	9,7 (21.1)	9,3 (20.1)	9,0 (19.8)	8,8 (19.0)	24,0 (80)	8,6 (18.9)	9,4 (20.8)	9,4 (20.8)	9,2 (20.2)	9,1 (19.9)
	30,0 (100)	7,4 (16.1)	7,1 (15.3)	6,6 (14.2)	6,3 (13.6)	6,1 (13.1)	30,0 (100)		7,2 (15.6)	6,8 (14.7)	6,5 (14.1)	6,4 (13.7)
	36,0 (120)		5,3 (11.6)	4,8 (10.4)	4,5 (9.8)	4,3 (9.3)	36,0 (120)			5,0 (10.7)	4,7 (10.2)	4,5 (9.7)
	42,0 (140)			3,6 (7.8)	3,3 (7.1)	3,0 (6.5)	42,0 (140)				3,4 (7.4)	3,2 (7.0)
	48,0 (160)				2,7 (5.8)	2,3 (4.9)	48,0 (160)					2,3 (—)
	52,0 (175)					1,7 (3.6)	52,0 (175)					
	56,0 (185)						56,0 (185)					
jib 15,2 m (50 ft)	Radius											
	10,0 (30)	9,0 (—)					10,0 (30)					
	12,0 (40)	9,0 (20.0)	9,0 (—)				12,0 (40)					
	14,0 (50)	9,0 (20.0)	9,0 (20.0)	9,0 (20.0)			14,0 (50)					
	18,0 (60)	9,0 (20.0)	9,0 (20.0)	9,0 (20.0)	9,0 (20.0)	9,0 (20.0)	18,0 (60)	5,1 (11.4)	5,1 (11.4)	5,1 (—)		
	24,0 (80)	7,7 (16.8)	8,9 (19.5)	9,0 (20.0)	9,0 (20.0)	8,9 (19.7)	24,0 (80)	5,1 (11.2)	5,1 (11.2)	5,1 (11.4)	5,1 (11.4)	
	30,0 (100)	6,2 (13.6)	7,2 (15.7)	6,8 (14.7)	6,5 (14.1)	6,3 (13.6)	30,0 (100)	4,4 (9.8)	4,8 (10.6)	5,1 (11.4)	5,1 (11.4)	
	36,0 (120)	5,2 (11.5)	5,5 (11.9)	5,0 (10.8)	4,7 (10.2)	4,5 (9.8)	36,0 (120)		4,3 (9.6)	4,7 (10.4)	4,9 (10.8)	4,9 (10.6)
	42,0 (140)		4,3 (9.3)	3,8 (8.2)	3,5 (7.5)	3,3 (7.1)	42,0 (140)			4,0 (8.6)	3,7 (8.1)	3,6 (7.7)
	48,0 (160)			2,9 (6.2)	2,5 (5.4)	2,2 (4.7)	48,0 (160)				2,7 (5.9)	2,5 (5.3)
	52,0 (175)				1,9 (4.0)	1,6 (3.3)	52,0 (175)					1,9 (3.8)
	58,0 (185)						58,0 (185)					

For complete chart, refer to www.cranelibrary.com.

Meets ASME B30.5 Requirements - Capacities do not exceed 75% of static tipping load.
NOTICE: This capacity chart is for reference only and must not be used for lifting purposes.

Fixed jib load charts

Model 12000-1 liftcrane fixed jib capacities - No. 12000-1 fixed jib on main boom

34 600 kg (76,280 lb) crane counterweight, 6 500 kg (14,330 lb) carbody counterweight crawler extended

360° Rating

kg (lb) x 1 000

10° offset						30° offset					
Boom m (ft)	27,4 (90)	36,6 (120)	48,8 (160)	54,9 (180)	61,0 (200)	Boom m (ft)	27,4 (90)	36,6 (120)	48,8 (160)	54,9 (180)	61,0 (200)
Radius						Radius					
jib 21,3 m (70 ft)	12,0 (45)	7,1 (15.7)				12,0 (45)					
	18,0 (60)	6,7 (14.8)	6,8 (15.1)	6,9 (15.4)	7,0 (15.6)	7,1 (15.7)	3,6 (—)				
	22,0 (75)	6,4 (13.9)	6,6 (14.4)	6,7 (14.8)	6,8 (15.0)	6,9 (15.1)	3,6 (8.1)	3,6 (8.1)			
	26,0 (90)	5,5 (11.5)	6,3 (13.3)	6,5 (14.3)	6,6 (14.4)	6,7 (14.6)	3,5 (7.6)	3,6 (8.1)	3,6 (8.1)	3,6 (8.1)	3,6 (8.1)
	32,0 (110)	4,4 (9.4)	5,1 (10.9)	6,0 (12.7)	6,0 (12.3)	5,8 (11.9)	3,0 (6.5)	3,3 (7.0)	3,5 (7.6)	3,6 (7.8)	3,6 (8.0)
	38,0 (130)	3,7 (7.9)	4,3 (9.2)	4,7 (9.7)	4,4 (9.1)	4,2 (8.6)	2,7 (—)	2,9 (6.3)	3,1 (6.9)	3,2 (7.1)	3,3 (7.3)
	44,0 (145)	3,2 (7.1)	3,7 (8.2)	3,6 (7.9)	3,3 (7.2)	3,1 (6.8)		2,6 (5.9)	2,9 (6.4)	3,0 (6.6)	3,0 (6.8)
	50,0 (170)		3,2 (6.8)	2,7 (5.6)	2,4 (4.7)	2,0 (4.1)			2,6 (5.9)	2,7 (5.5)	2,5 (4.9)
	54,0 (180)			2,2 (4.8)	1,8 (3.9)					2,1 (4.5)	1,8 (3.9)
	56,0 (190)			2,0 (4.0)	1,6 (—)						1,6 (—)
	60,0 (200)			1,6 (3.3)							

For complete chart, refer to www.cranelibrary.com.

Meets ASME B30.5 Requirements - Capacities do not exceed 75% of static tipping load.
 NOTICE: This capacity chart is for reference only and must not be used for lifting purposes.

Clamshell

Boom:

Welded lattice construction using tubular, high-tensile steel chords with pin connections between sections.

Basic boom length: 15,2 m (50 ft)

Max. boom length: 30,5 m (100 ft)

Limit of empty clamshell bucket weight: 2 100 kg (4,600 lb)

Boom component chart

Boom length m (ft)	Boom arrangement
15,2 (50)	Base-Tip
18,3 (60)	Base-A-Tip
21,3 (70)	Base-A-A-Tip, Base-B-Tip
24,4 (80)	Base-A-B-Tip
27,4 (90)	Base-A-A-B-Tip, Base-B-B-Tip, Base-C-Tip
30,5 (100)	Base-A-B-B-Tip, Base-A-C-Tip

Base = 7,6 m (25 ft)

Insert: A = 3,05 m (10 ft)

B = 6,10 m (20 ft)

C = 12,2 m (40 ft)

Tip = 7,2 m (25 ft)

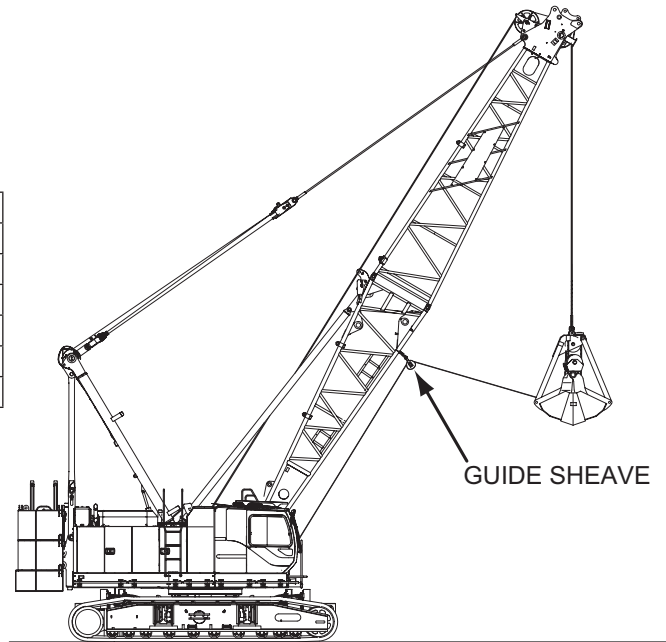

1. Figures represent maximum allowable capacity, and assume level ground and ideal working conditions.
2. Capacities are calculated at 66% of the minimum tipping loads.
3. Capacities are maximum recommended by PCSA Standard #4. Allowances must be made by the user for such unfavorable conditions as a soft or uneven supporting surface, rapid cycle operations, or bucket suction.
4. The combined weight of the bucket and load must not exceed these capacities.
5. Boom length for clamshell operation should not exceed 30,5 m (100 ft).

Clamshell Capacities

10 000 kg (22,050 lb) counterweight
(one upper counterweight, crawlers extended)

kg (lb) x 1 000

Boom m (ft)	15,2 (50)	18,3 (60)	21,3 (70)	24,4 (80)	27,4 (90)	30,5 (100)
Radius						
7,0 (22)	10,0 (25.0)					
8,0 (26)	10,0 (25.0)					
9,0 (30)	10,0 (25.0)	10,0 (25.0)				
10,0 (34)	10,0 (25.0)	9,7 (25.0)	9,7 (25.0)			
14,0 (45)	10,0 (23.1)	7,8 (22.9)	7,8 (22.7)	7,8 (22.5)	7,8 (21.6)	
15,0 (50)		6,6 (19.8)	6,6 (19.6)	6,6 (19.4)	6,6 (19.2)	6,6 (18.5)
17,0 (55)		5,7 (12.5)	5,7 (17.2)	5,7 (17.0)	5,7 (16.8)	5,7 (16.5)
18,0 (60)			5,0 (15.2)	5,0 (15.0)	5,0 (14.8)	5,0 (14.6)
21,0 (70)				4,4 (11.9)	4,3 (11.7)	4,2 (11.5)
24,0 (80)					— (9.5)	— (9.3)
25,0 (85)						— (8.4)
27,0 (90)						— (7.7)

Manitowoc Crane Care

Crane Care is Manitowoc's comprehensive service and support program. It includes classroom and on-site training, prompt parts availability, expert field service, technical support and documentation.

That's commitment you won't find anywhere else.

That's Crane Care.

Service training

Manitowoc specialists work with you in our training centers and in the field to make sure you know how to get maximum performance, reliability and life from your cranes.

Manitowoc Cranes Technical Training Centers provide valuable multi-level training, which is available for all models and attachments, in the following format:

- **Intro to Canbus and Canbus 1, 2, 3**
- **Intro to EPIC and EPIC 1, 2, 3**
- **Small Crawler 1**
- **Canbus 1 and 2 assembly, operation and maintenance**
- **EPIC 1 and 2 assembly, operation and maintenance**

Refer to www.manitowoc.com for course descriptions.

Parts availability

Genuine Manitowoc replacement parts are accessible through your distributor 24 hours a day, 7 days a week, 365 days a year.

Service interval kits

200 hour kit

1,000 hour kit

2,000 hour kit

Hydraulic test kit

U.S. standard tools kit

Field service

Factory-trained service experts are always ready to help maintain your crane's peak performance.

For a worldwide listing of dealer locations, please consult our website at: www.manitowoc.com

Technical support

Manitowoc's dealer network and factory personnel are available 24 hours a day, 7 days a week, 365 days a year to answer your technical questions and more, with the help of computerized programs that simplify crane selection, lift planning, and ground-bearing calculations.

For a worldwide listing of dealer locations, please consult our website at: www.manitowoc.com

Technical documentation

Manitowoc has the industry's most extensive documentation; available in major languages and formats that include print, videotape, and DVD/CD.

Additional copies available through your Authorized Manitowoc Distributor.

- Crane operator's manual
- Crane parts manual
- Crane capacity manual
- Crane vendor manual
- Crane service manual
- Luffing jib operator's/parts manual
- Capacity chart manual - attachments

Available from your Authorized Manitowoc Cranes Distributor, these videos are available in NTSC, PAL, SECAM, and DVD formats.

- Your Capacity Chart Video
- Respect the Limits Video
- Crane Safety Video
- Boom Inspection/Repair Video

Crane Care Package

Manitowoc has assembled all of the available literature, CD's and videos listed above plus several Manitowoc premiums into one complete Crane Care Package, which is supplied to the owner of each new crane.

Manitowoc Cranes

Regional headquarters

Americas

Manitowoc, Wisconsin, USA

Tel: +1 920 684 6621

Fax: +1 920 683 6277

Shady Grove, Pennsylvania, USA

Tel: +1 717 597 8121

Fax: +1 717 597 4062

Europe, Middle East, Africa

Ecully, France

Tel: +33 (0)4 72 18 20 20

Fax: +33 (0)4 72 18 20 00

China

Shanghai, China

Tel: +86 21 6457 0066

Fax: +86 21 6457 4955

Greater Asia-Pacific

Singapore

Tel: +65 6264 1188

Fax: +65 6862 4040

Regional offices

Americas

Brazil

Alphaville

Mexico

Monterrey

Chile

Santiago

Europe, Middle East,

Africa

France

Baudemont

Cergy

Decines

Germany

Langenfeld

Italy

Lainate

Netherlands

Breda

Poland

Warsaw

Portugal

Baltar

Russia

Moscow

South Africa

Johannesburg

U.A.E.

Dubai

U.K.

Buckingham

China

Beijing

Chengdu

Guangzhou

Xian

Greater Asia-Pacific

Australia

Brisbane

Melbourne

Sydney

India

Chennai

Delhi

Hyderabad

Pune

Korea

Seoul

Philippines

Makati City

Singapore

Factories

Brazil

Passo Fundo

China

TaiAn

Zhangjiagang

France

Charlieu

Moulins

Germany

Wilhelmshaven

India

Pune

Italy

Niella Tanaro

Portugal

Baltar

Fânzeres

Slovakia

Saris

USA

Manitowoc

Port Washington

Shady Grove

This document is non-contractual. Constant improvement and engineering progress make it necessary that we reserve the right to make specification, equipment, and price changes without notice. Illustrations shown may include optional equipment and accessories and may not include all standard equipment.