

Manitowoc 10000A-1

Product Guide

ASME B30.5
Imperial



Features

- 100 USt capacity
- 200 ft heavy-lift boom
- Max boom + jib combination:
190 ft + 60 ft
- 285 HP engine
- 535 fpm maximum line speed
- 25,200 lb rated line pull

Features



Self-erecting counterweight

Eliminates the need for an assist crane, and also allows for reduced counterweight chart operation.



Retractable crawlers

Crawlers can be extended and retracted for better jobsite maneuverability. On some models, these crawlers can also ship attached for easier transport and quicker setup.

Energy saving systems

Green-Engine mode conserves fuel during full speed drum operation under load, at a lower engine RPM. Other available options include Green-Winch Mode and Auto Idling Stop Mode.

Contents

Specifications	4
Outline dimensions	7
Winch performance data	13
Load chart notes	14
Boom combinations	15
Heavy-lift boom range / charts	16
Fixed jib boom range / load charts	18
Clamshell	21
Manitowoc Crane Care	22

Specifications

Upperworks



Engine

HINO J08E-UV, 6 cylinder, water-cooled diesel, direct fuel injection with turbocharger, 285 HP at 2100 high-idle RPM. Maximum torque 750 lb•ft net at 1,600 rpm; Interim Tier 4/Stage IIB (Required for sale in the US/Canada/Europe; requires "Ultra Low Sulfur Diesel")

One diesel fuel tank, 105 gallons capacity.

Two 12 volt 136 AH capacity batteries, 24 volt system and 90 amp alternator.

All wiring harnesses and connectors are numbered for easier servicing. Machine is equipped with individual fused branch circuits.



Controls

Full-flow hydraulic control system for constant variable pressure to front and rear drums, boom hoist brakes and clutches. Controls respond instantly to the touch, delivering smooth function operation.



Hydraulic system

All three variable displacement piston-type pumps are driven by a heavy-duty pump drive. One of these pumps is used in the left propel circuit and hook hoist circuit, and can accommodate an optional third circuit. Another is used in the right propel circuit, boom hoist circuit and hook hoist circuit. The third variable displacement pump is used in the swing circuit. In addition, two gear pumps are used in the control system and auxiliary equipment, and two gear pumps serve the brake cooling system.

Maximum pressure rating 4,630 psi

Load hoist, boom hoist and propel . . . 2 Piston pumps
Swing 1 Piston pump
Control system and auxiliary 2 Gear pumps
Brake cooling system 2 Gear pumps

Reservoir capacity: 116 US gallon

Cooling: oil-to-air heat exchanger

Filtration: full-flow and bypass type with replaceable paper elements.



Drums

Front and rear drums for load hoist powered by variable displacement piston-type motors, driven through planetary reducers. Powered hoisting/lowering and free-fall operation is standard. Drum turn indicators for front and rear drums are also standard.

Drums: (front and rear) 24.2" P.C.D. x 24.3" wide drums, grooved for 26.0 mm wire rope.

Brakes: Counterbalance valve and spring set hydraulically released multiple disk brake mounted on hoist motor. External ratchet is fitted for locking drum.

Wire rope capacity:

Front drum 771 ft working length
 Rear drum 525 ft working length

Line speed: Single line on the first drum layer

Hoisting: 390 ft/min

Lowering: 390 ft/min

➤ **Optional third drum:** grooved for 22 mm wire rope; free-fall is optional.

Wire rope working length 476'



Swing system

Swing unit: Powered by a hydraulic piston-type motor driving spur gears through planetary reducers, the swing system provides 360° rotation.

Swing brake: A spring-set, hydraulically released multiple-disc brake is mounted on swing motor.

Swing lock: 4-Position lock for transportation.

Rotating bed turntable: Single-row ball bearing with an integral internally cut swing gear.

Swing speed: 4.0 rpm



Boom support system

Single drum powered by a hydraulic axial piston motor through a planetary reducer.

Brake: A spring-set, hydraulically released multiple-disc brake is mounted on the boom hoist motor. An external ratchet is fitted for locking the drum.

Drum: Single drum, grooved for 16 mm diameter wire rope. Boom hoist reeving is 12-part line.

Wire Rope Capacity:

Drum 492 ft working length.

Specifications

Line speed: Single line on first drum layer.

Hoisting 230 ft/min
Lowering 230 ft/min



Gantry

This high folding type gantry is fitted with a sheave frame for boom hoist reeving. It provides full up, full down positions.



Counterweight

Upper weight (5 pieces): 69,000 lb
Carbody weight (2 pieces): 31,750 lb



Operator's cab

Totally enclosed, full vision cab fitted with tinted safety glass and opening front window. A fully adjustable, highbacked seat with arm rests. Short handle control levers; electronic twist grip hand throttle. An air conditioner, a signal horn and windshield wiper are standard.

Lights:

- 2 - Front flood lights
- 1 - Cab inside light

Safety device

New easy to read at a glance LMI and maintenance display.

Lowerworks



Carbody

The durable carbody features steel welded construction with extendible axles.



Crawlers

Crawler assemblies can be hydraulically extended for wide-track operation or retracted for transportation.

Crawler belt tension adjusted with hydraulic jack and maintained by shims between idler block and frame.

The independent hydraulic propel drive is built into each crawler side frame. Each drive consists of a hydraulic motor propelling a driving tumber through

a planetary gearbox. Hydraulic motor and gear box are built into the crawler side frame within the shoe width. The track rollers are sealed for maintenance-free operation.

Crawler brakes: multiple disk type, spring set hydraulically released parking brakes are built into each propel drive.

Crawler shoes

36" wide crawler.

Travel speed

(High/Low) 1.07/0.71 mph

Attachments



Boom

Welded lattice construction using tubular, high-tensile steel chords with pin connections between sections.

Two idler sheaves and three point sheaves are standard.

Basic boom length 50'. Basic boom consists of the boom butt 19', boom insert 10' and boom top 21'.

Optional boom inserts are welded lattice construction with tubular, high-tensile steel chords and pin connections on each one of 10', 20' and 40' inserts.

Maximum total length of boom 200'.



Fixed jib

The optional fixed jib employs welded lattice construction with tubular, high-tensile steel chords with pin connections between sections.

Basic jib length 30'. Basic jib length consists of jib butt section 15' and jib top 15'.

Optional jib boom inserts of 10', 20' are available for extension capabilities up to 60'.

Maximum total length of boom and jib 190' + 60' is 250'.

Tool and accessories

A set of tools and accessories are furnished.

Optional Equipment

➤ Optional: Blocks and hooks each with roller bearing sheaves grooved for 26.0 mm diameter wire rope, and roller bearing swivel with hook latch.

Specifications

- 12 USt ball hook, 722 lb wedge socket for 26 mm wire rope.
- 50 USt hook block, 2,311 lb with three 24" Nominal O.D. roller bearing sheaves.
- 75 USt hook block, 3,820 lb, with four 24" Nominal O.D. roller bearing sheaves.
- 100 USt hook block, 2,946 lb with four 24" Nominal O.D. roller bearing sheaves.
- Optional: Detachable upper boom point with one 575 mm Nominal outer diameter roller bearing steel sheave grooved for 26mm rope for liftcrane.
- Machine inclination sensor.
- Swing angle detection and angle limiter.
- Counterweight detection.
- Hydraulic tagline.
- External lamp for overload alarm.

Working weight

Approximately 198,500 lb including upperworks and lowerworks, full upper counterweights, full carbody counterweights, and (50') basic boom.

Ground pressure

Approximately 12.9 psi with basic boom and no load.

Gradeability

With basic boom: 40%.

Specifications

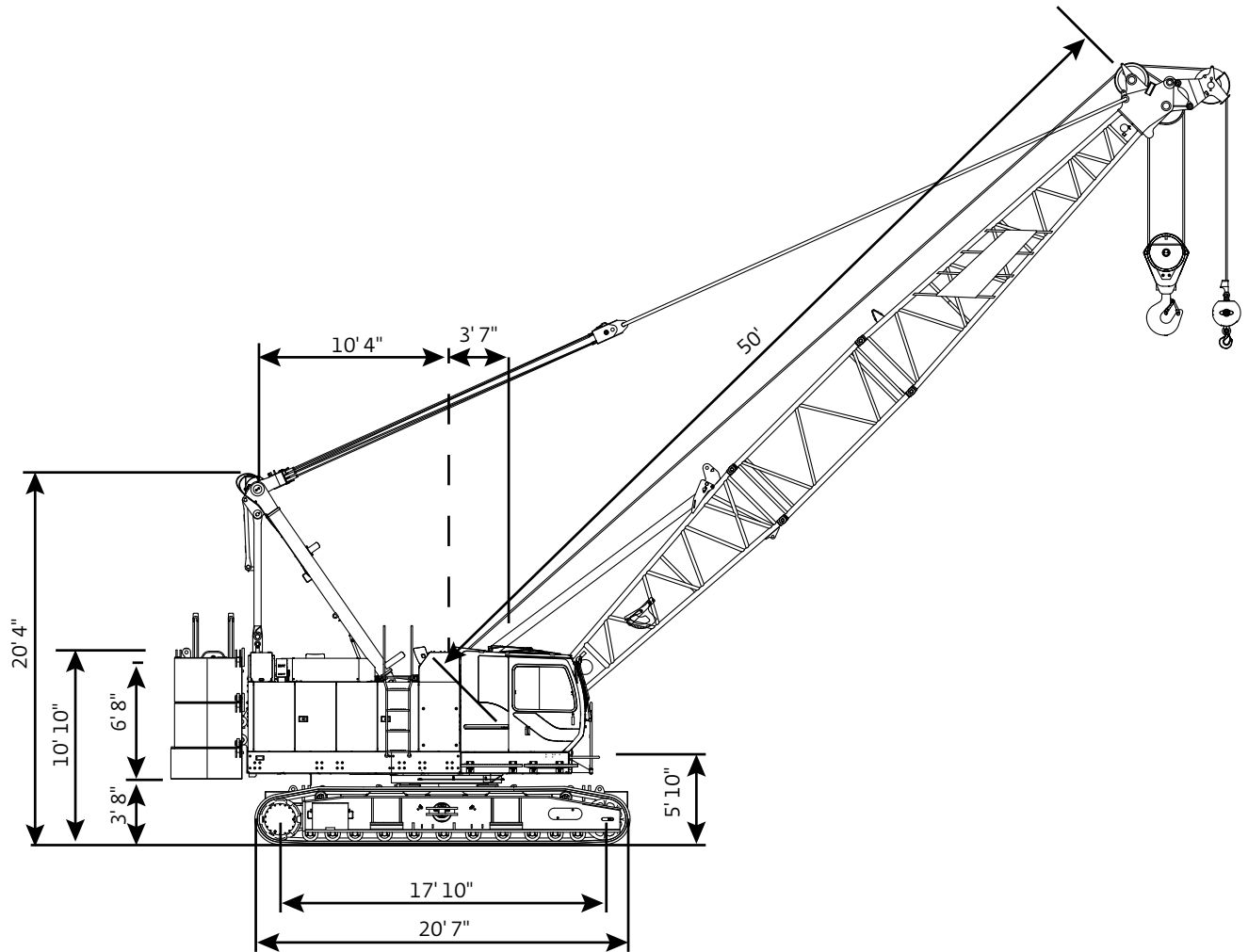

Outline dimensions

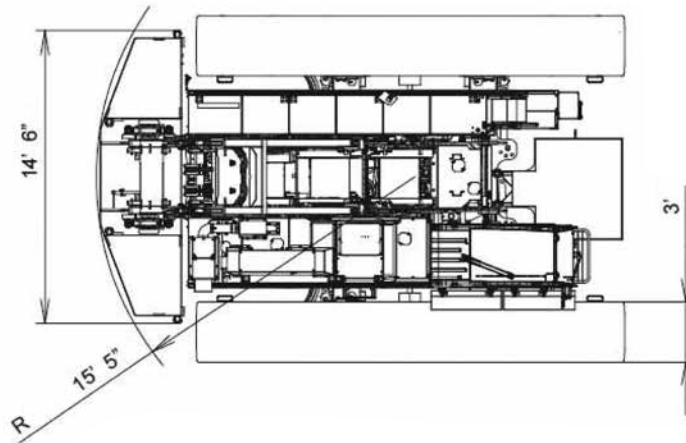
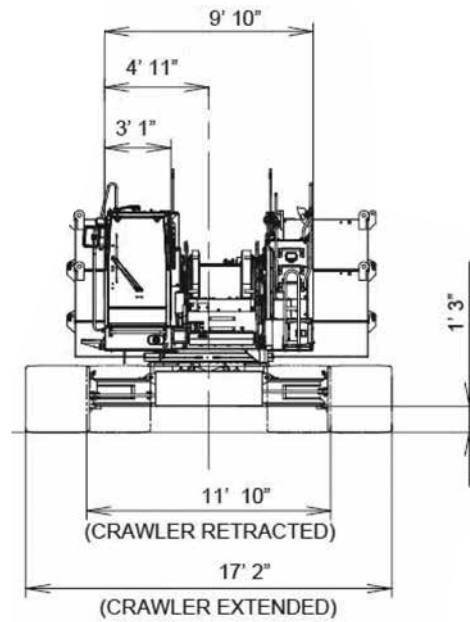

Outline dimensions

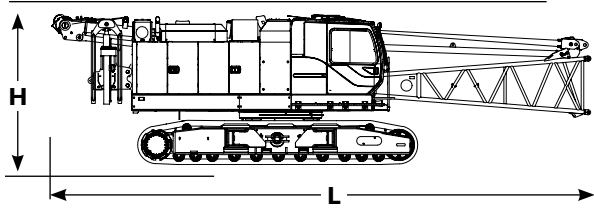

Upperworks x 1	
Length	39' 8"
Width	11' 10"
Height	10' 11"
Weight	95,128 lb

Note: Weight includes base machine, crawler, gantry, maximum hoist and whip lines on drums, boom butt, full hydraulic fluid reservoir, and one third tank of fuel.

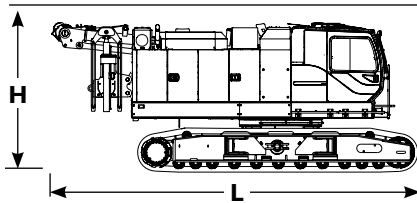

Upperworks x 1	
Length	26' 11"
Width	11' 10"
Height	10' 11"
Weight	90,586 lb

Note: Weight includes base machine, crawler, gantry, maximum hoist and whip lines on drums, full hydraulic fluid reservoir, and one third tank of fuel.

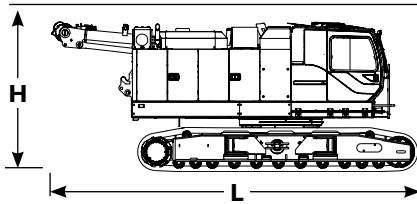

Upperworks x 1	
Length	26' 11"
Width	11' 10"
Height	10' 11"
Weight	88,668 lb

Note: Weight includes base machine, crawler, gantry, maximum hoist and whip lines on drums without self-removal unit, full hydraulic fluid reservoir, and one third tank of fuel.

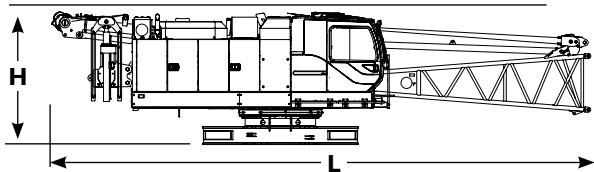

Upperworks without crawlers x 1	
Length	39' 8"
Width	9' 10"
Height	9' 8"
Weight	61,442 lb

Note: Weight includes base machine, gantry, maximum hoist and whip lines on drums, boom butt, full hydraulic fluid reservoir, and one third tank of fuel.

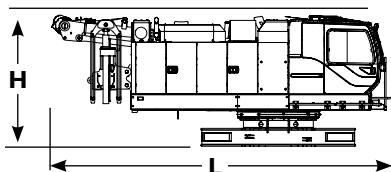

Upperworks without crawlers x 1	
Length	25' 3"
Width	9' 10"
Height	9' 8"
Weight	56,900 lb

Note: Weight includes base machine, gantry, maximum hoist and whip lines on drums, full hydraulic fluid reservoir, and one third tank of fuel.

▶ Option

Outline dimensions

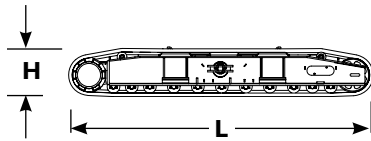

Crawlers	x 2
Length	20' 7"
Width	3' 0"
Height	3' 3"
Weight	16,843 lb

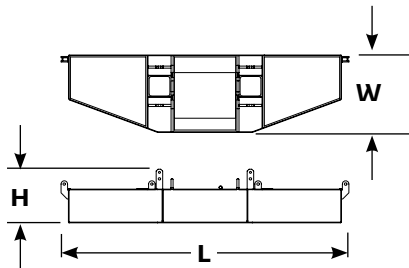

Upper counterweight	x 1
Length	14' 6"
Width	3' 11"
Height	2' 9"
Weight	18,320 lb

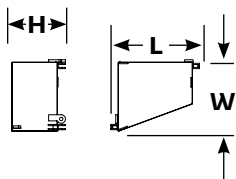

Upper counterweight (R)	x 2
Length	4' 9"
Width	3' 10"
Height	2' 11"
Weight	12,677 lb

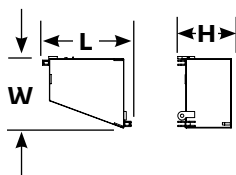

Upper counterweight (L)	x 2
Length	4' 9"
Width	3' 10"
Height	2' 11"
Weight	12,677 lb

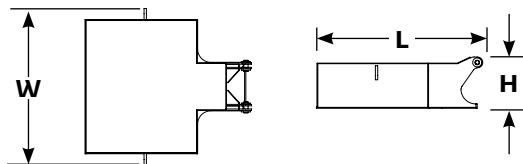

Carbody counterweight	x 2
Length	6' 3"
Width	5' 10"
Height	1' 11"
Weight	15,873 lb

Outline dimensions

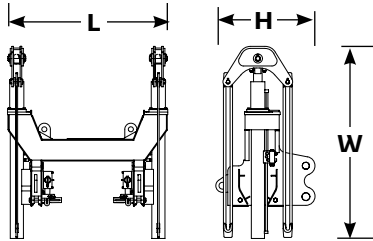

Self removal unit	x 1
Length	5' 3"
Width	6' 3"
Height	3' 3"
Weight	1,918 lb

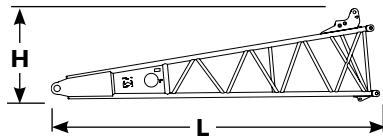

Boom butt 19'	x 1
Length	19' 7"
Width	4' 11"
Height	5' 7"
Weight	3,252 lb

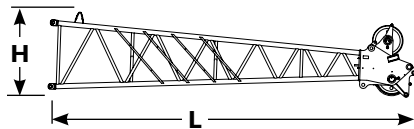

Boom top 21'	x 1
Length	22' 8"
Width	4' 11"
Height	4' 4"
Weight	2,580 lb

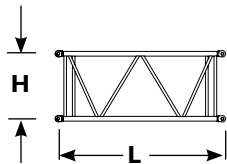

Boom insert 10'	x 1,2
Length	10' 4"
Width	4' 11"
Height	4' 4"
Weight	685 lb

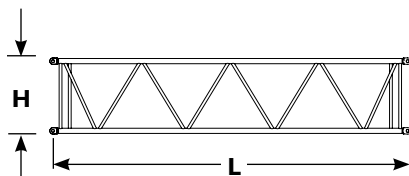

Boom insert 20'	x 1,2
Length	20' 5"
Width	4' 11"
Height	4' 4"
Weight	1,145 lb

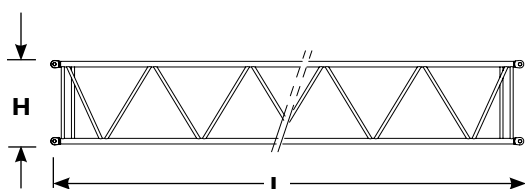

Boom insert 40'	x 1,2,3
Length	40' 5"
Width	4' 11"
Height	4' 4"
Weight	2,115 lb

Note: Use one "A" type insert with lug required for any boom combinations that require a 40' insert.

▶ Option

Outline dimensions

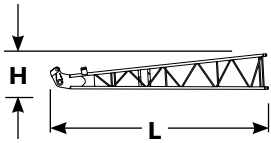

Fixed jib butt	x 1
Length	15' 9"
Width	2' 8"
Height	2' 8"
Weight	440 lb

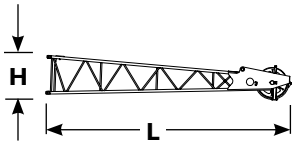

Fixed jib top	x 1
Length	16' 5"
Width	2' 7"
Height	2' 8"
Weight	617 lb

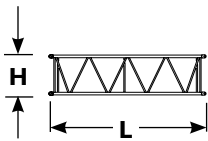

Fixed jib insert 10'	x 1
Length	10' 2"
Width	2' 8"
Height	2' 8"
Weight	220 lb

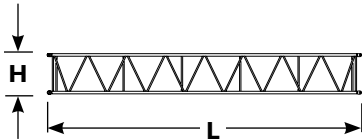

Fixed jib insert 20'	x 1
Length	20' 3"
Width	2' 8"
Height	2' 8"
Weight	395 lb

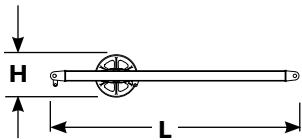

Fixed jib strut	x 1
Length	11' 11"
Width	2' 9"
Height	2' 0"
Weight	550 lb

Winch performance data

Line pull		
	Rated line pull lb	*Maximum line pull lb
Front drum	25,200	46,800
Rear drum	25,200	46,800
Optional 3rd drum	17,700	34,400

* Maximum line pull is not based on wire rope strength.

Wire rope specifications				
Use	Specs	Diameter mm	Working length ft	Breaking strength lb
Front drum	IWRC C/O 6 X Fi (29)	26,0	771	120,000
Rear drum	IWRC C/O 6 X Fi (29)	26,0	525	120,000
Boom hoist drum	IWRC C/O 6 X Fi (31)	16,0	492	47,200
Optional 3rd drum	IWRC C/O 6 X Fi (29)	22,0	476	81,600

Front and rear winch						
		Line speed ft/min				
Layer		1	2	3	4	5
Rated line pull	Single line pull lb					
	0	410	436	466	495	525
	5,000	406	434	463	492	522
	10,000	355	355	355	355	355
	15,000	237	237	237	237	237
	20,000	177	177	177	177	177
	25,000	142	142	142	142	142
	30,000	118	118	119	126	133
	35,000	104	111	118	125	–
	40,000	104	111	–	–	–

NOTE: Line speeds and line pull based on single line.
Line pulls are not based on wire rope strength.

Load chart notes

- Rated loads included in the charts are the maximum allowable freely suspended loads at a given boom length, boom angle and load radius, and have been determined for the machine standing level on firm supporting surface under ideal operating conditions. The user must limit or de-rate rated loads to allow for adverse conditions (such as soft or uneven ground, out-of-level conditions, wind side loads, pendulum action, jerking or sudden stopping of loads, inexperience of personnel, multiple machine lifts, and traveling with a load).
- Capacities do not exceed 75% of minimum tipping loads. Capacities based on factors other than machine stability such as structural competence are shown by asterisk * in the charts located in the operator's crane cab.
- The machine must be reeved and set-up as stated in the operation manual and all the instruction manuals. If these manuals are missing, obtain replacements. Boom backstops are required for all boom lengths. Gantry must be in the fully raised position for all operations. Crawlers must be fully extended and be locked in position. The crane must be leveled to within 1% on a firm supporting surface.
- Do not attempt to lift where no radius or load is listed as crane may tip or collapse.
- Attempting to lift more than rated loads may cause machine to tip or collapse. Do not tip machine to determine capacity.
- Weight of hooks, hook blocks, slings and other lifting devices are a part of the total load. Their total weight must be subtracted from the rated load to obtain the weight that can be lifted.
- When lifting over boom point with jib or upper boom point installed, rated loads for the boom must be deducted as shown below.

Jib length ft	Upper boom point	30	40	50	60
Deduct lb	420	2,500	3,700	5,100	6,700

- The total load that can be lifted by the fixed jib is limited by rated jib loads. The total load that can be lifted with the upper boom point is limited by rated upper boom point loads.

- Boom lengths for fixed jib mounting are 80 ft to 190 ft.
- The total load that can be lifted by the upper boom point is: the rated load for the boom (without upper boom point installed) minus 420 lb; however, the upper boom point rated load should not exceed 24,000 lb.
- An upper boom point cannot be used on a 200 ft boom length.
- The boom should be erected over the front of the crawlers, not laterally. When erecting and lowering the boom with a length of 190 ft with jib, blocking must be placed at the end of the crawlers. See operator's manual for details.
- Least stable position is over the side.
- Maximum hoist load for number of reeving parts of line for hoist rope.

Maximum load for main boom

No. of parts of line	1	2	3	4	5
Maximum loads lb	25,200	50,400	75,600	100,800	126,000

No. of parts of line	6	7	8
Maximum loads lb	151,200	176,400	200,000

Maximum load for fixed jib

No. of parts of line	1
Maximum loads lb	24,000

Maximum load for upper boom point

No. of parts of line	1
Maximum loads lb	24,000

- Lifting capacities listed apply only to the machine as originally manufactured for and supplied by Manitowoc Cranes, Inc. Modifications to this machine or use of equipment other than that specified can reduce operating capacity.
- Designed and rated to comply with ASME Code B30.5.

Operation of this equipment in excess of rated loads or disregard of instruction voids the warranty.

Boom combinations

No. 10000A-1 heavy-lift boom combinations

Boom length ft	Boom inserts		
	10 ft	20 ft	40 ft
50	1	-	-
60	2	-	-
70	1	1	-
80	2	1	-
90	1	2	-
100	2	2	-
110	1	1	1*
120	2	1	1*
130	1	2	1*
140	2	2	1*
150	1	1	2*
160	2	1	2*
170	1	2	2*
180	2	2	2*
190	1	1	3*
200	2	1	3*
200	2	1	3*

* NOTE: One 40 ft boom insert with lug 40A is required for fixed jib. When no jib is installed a 40 ft boom can be used instead of 40A.

No. 10000A-1 fixed jib combinations

Fixed jib length ft	Fixed jib inserts	
	10 ft	20 ft
30	-	-
40	1	-
50	-	1
60	1	1

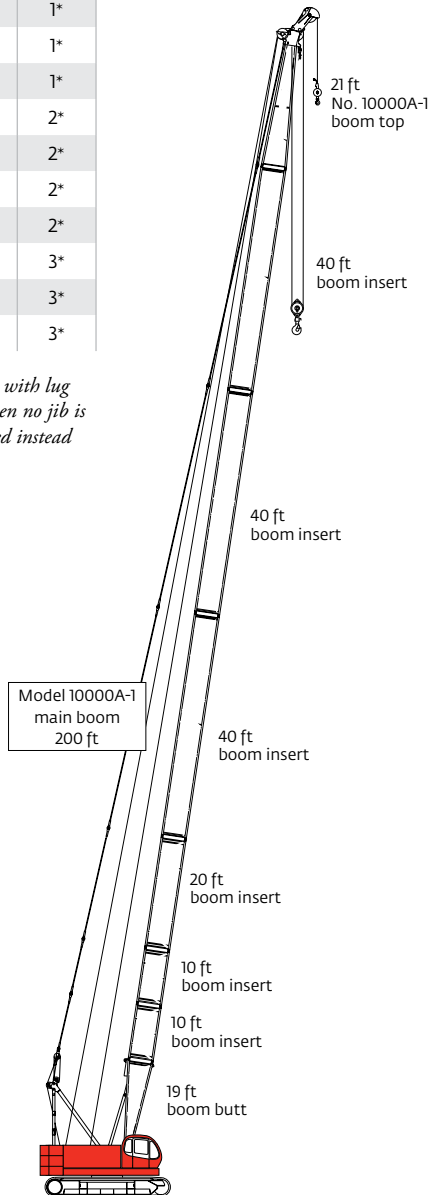

**Model 10000A-1
Main boom 200 ft**

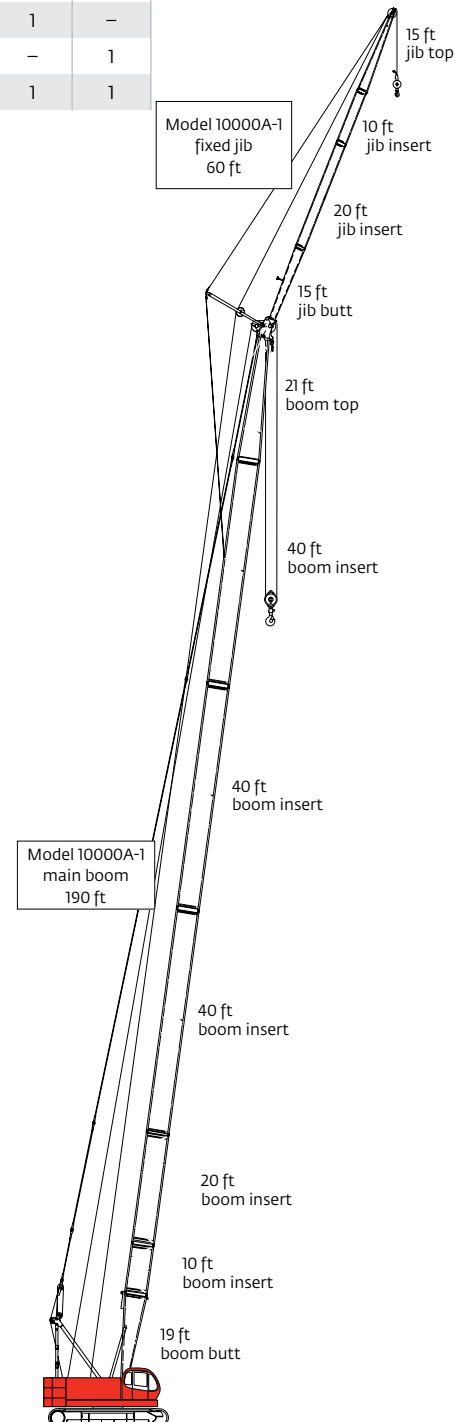

**Model 10000A-1
Fixed jib on main boom
250 ft**

Heavy-lift boom range diagram

No. 10000A-1 main boom

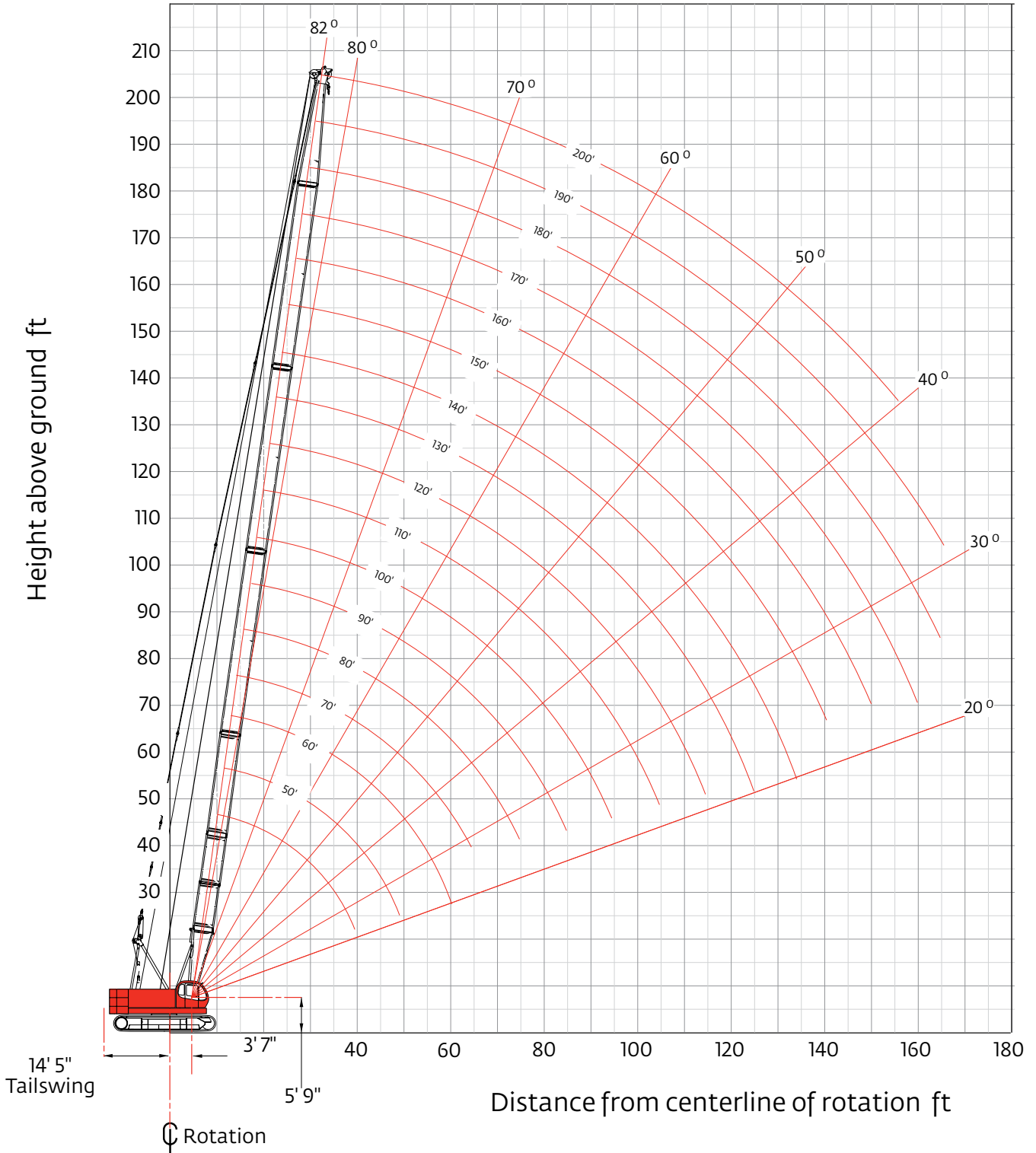

Heavy-lift boom load charts

Model 10000A-1 liftcrane boom capacities – 10000A-1 main boom

69,000 lb upper counterweight + 31,750 lb carbody counterweight

360° Rating

lb x 1 000

Boom ft	50	60	70	80	90	100	110	120	130	140	150	160	170	180	190	200
Radius																
12	200.0*															
14	187.8*	187.4*														
16	165.3*	164.8*	151.0*	151.0*												
18	147.4*	146.9*	146.7*	146.5*	125.8*	123.6*										
20	132.4	132.2	132.2	131.8	124.0*	100.6*	100.8*									
24	101.0	100.8	101.3	101.0	100.8*	80.2*	96.5*	94.2*	85.1*	72.9*						
28	80.7	80.5	80.8	80.5	80.5	61.3	80.2*	79.9*	78.2*	70.8*	61.3*	50.2*				
34	62.0	61.6	62.0	61.6	61.6	48.9	61.3	61.1	60.9	60.5*	57.2*	49.2*	43.2*	38.2*	33.8*	30.3*
40	49.8	49.3	49.8	49.3	49.3	43.4	48.9	48.7	48.4	48.2	48.0*	46.6*	41.2*	36.4*	32.2*	28.7*
44	44.3	43.8	44.1	43.8	43.7	32.3	43.4	43.0	42.8	42.6	42.4	42.1*	40.0*	35.1*	31.1*	27.7*
55		32.9	33.2	32.7	32.5	21.4	32.3	32.0	31.6	31.4	31.2	31.4	31.2*	30.8*	28.1*	24.9*
75				22.1	21.8	15.8	21.4	21.2	20.9	20.5	20.3	20.5	20.3	19.9	19.9	18.5*
95							15.6	15.3	15.0	14.6	14.4	14.5	14.3	14.0	13.9	13.5
110								12.6	12.1	11.9	11.7	11.7	11.5	11.1	11.0	10.6
120									10.8	10.3	10.3	10.1	9.8	9.6	9.4	9.2
130										9.2	8.9	8.9	8.7	8.5	8.2	7.8
140											8.0	7.9	7.7	7.4	7.2	6.5
150												7.1	6.8	6.5	6.3	5.2*
160													5.9	5.6	5.3	
165														5.1	4.6	

*Rated loads based on factors other than machine stability such as structural competence.
For complete chart, refer to www.cranelibrary.com.

Meets ASME B30.5 Requirements - Capacities do not exceed 75% of static tipping load.
NOTICE: This capacity chart is for reference only and must not be used for lifting purposes.

Fixed jib range diagram

No. 1000A-1 fixed jib on main boom

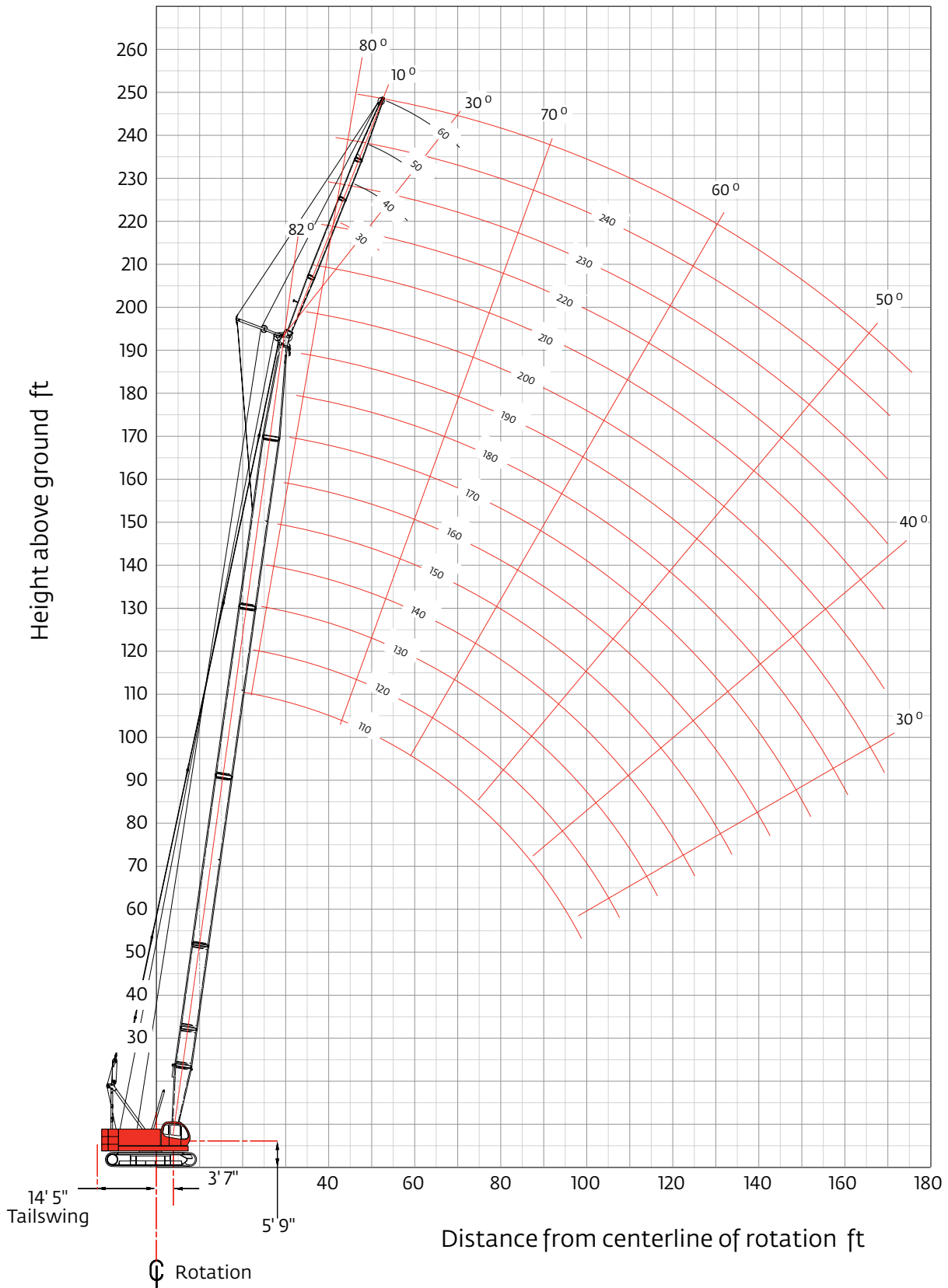

Fixed jib load charts

Model 10000A-1 liftcrane jib capacities No. 10000A-1 fixed jib on main boom

63,500 lb upper counterweight, 16,100 lb carbody counterweight crawler extended
360° Rating lb x 1 000

		10° Offset					30° Offset							
		Boom ft	80	100	130	160	190	Boom ft	80	100	130	160	190	
Jib length 30 ft	Radius							Radius						
	30		24.0					30						
	40		24.0	24.0	24.0			40		21.0				
	50		24.0	24.0	24.0	24.0	19.4	50		19.5	20.6	21.0		
	60		24.0	24.0	24.0	23.7	18.6	60		17.5	18.6	20.1	21.0	18.2
	80		17.3	16.8	16.1	15.5	14.8	80		14.8	15.9	16.6	16.0	15.5
	100		12.8	12.2	11.5	10.9	10.2	100				11.8	11.2	10.6
	120				8.5	7.9	7.2	120					8.2	7.5
	140				6.1	5.8	4.8	140						5.2
	150					4.7	3.9	150						4.2
					3.6		160							
							170							

		10° Offset					30° Offset							
		Boom ft	80	100	130	160	190	Boom ft	80	100	130	160	190	
Jib length 40 ft	Radius							Radius						
	30							30						
	40		24.0	24.0				40		14.4	15.1			
	50		24.0	24.0	24.0	24.0		50		12.9	13.6	14.5	15.1	
	60		20.7	23.2	24.0	24.0	18.5	60		10.9	11.6	12.5	13.2	13.8
	80		15.6	17.0	16.3	15.7	15.1	80			10.3	11.1	11.6	11.0
	100		12.6	12.4	11.7	11.1	10.4	100				8.9	8.4	7.8
	120			9.4	8.7	8.0	7.3	120					6.2	5.5
	140				6.6	5.9	5.0	140						4.4
	150				5.3	5.0	4.1	150						
160					4.0	3.2	160							
170					3.1		170							

For complete chart, refer to www.cranelibrary.com.

Meets ASME B30.5 Requirements - Capacities do not exceed 75% of static tipping load.
NOTICE: This capacity chart is for reference only and must not be used for lifting purposes.

Fixed jib load charts

Model 10000A-1 liftcrane jib capacities No. 10000A-1 fixed jib on main boom

63,500 lb upper counterweight, 16,100 lb carbody counterweight crawler extended
360° Rating lb x1000

		10° Offset					30° Offset				
Boom ft		80	100	130	160	190	80	100	130	160	190
jib length 50 ft	Radius										
	30										
	40	20.0	20.0								
	50	20.0	20.0	20.0							
	60	17.0	18.9	20.0	20.0	18.4	10.4	10.9	11.4		
	80	12.8	14.4	16.5	15.9	15.3	8.7	9.2	9.8	10.3	10.7
	100	10.3	11.6	11.8	11.2	10.5	7.6	8.0	8.7	9.2	9.6
	120		9.5	8.8	8.2	7.5			7.6	8.3	8.1
	140			6.7	6.1	5.2				6.4	5.7
	150			5.8	5.2	4.2				5.5	4.7
160			4.6	4.3						3.8	
170				3.4							

		10° Offset					30° Offset				
Boom ft		80	100	130	160	190	80	100	130	160	190
jib length 60 ft	Radius										
	30										
	40	18.0									
	50	17.8	18.0	18.0							
	60	14.8	16.3	18.0	18.0	18.0	8.9				
	80	11.1	12.3	14.1	15.6	15.4	7.3	7.7	8.1	8.5	8.7
	100	8.8	9.9	11.4	11.3	10.7	6.2	6.6	7.1	7.5	7.8
	120	7.3	8.2	8.9	8.3	7.5		5.9	6.3	6.7	7.0
	140		7.1	6.8	6.1	5.2			5.8	6.2	5.9
	150			6.0	5.3	4.3				5.7	4.9
160			5.0	4.4	3.4				4.9	4.0	
170			4.0	3.6						3.2	

For complete chart, refer to www.cranelibrary.com.

Meets ASME B30.5 Requirements - Capacities do not exceed 75% of static tipping load.
NOTICE: This capacity chart is for reference only and must not be used for lifting purposes.

Clamshell

Boom:

Welded lattice construction using tubular, high-tensile steel chords with pin connections between sections.

Basic boom length: 50 ft

Max. boom length: 100 ft

Limit one clamshell bucket weight: 4,600 lb

Maximum component chart

Boom length ft	Boom arrangement
50	Base-A-Tip
60	Base-A-A-Tip, Base-B-Tip
70	Base-A-B-Tip
80	Base-A-A-B-Tip, Base-B-B-Tip
90	Base-A-C-Tip
100	Base-A-A-C-Tip

Base = 20 ft

Insert: A = 10 ft

B = 20 ft

C = 40 ft

Tip = 20 ft

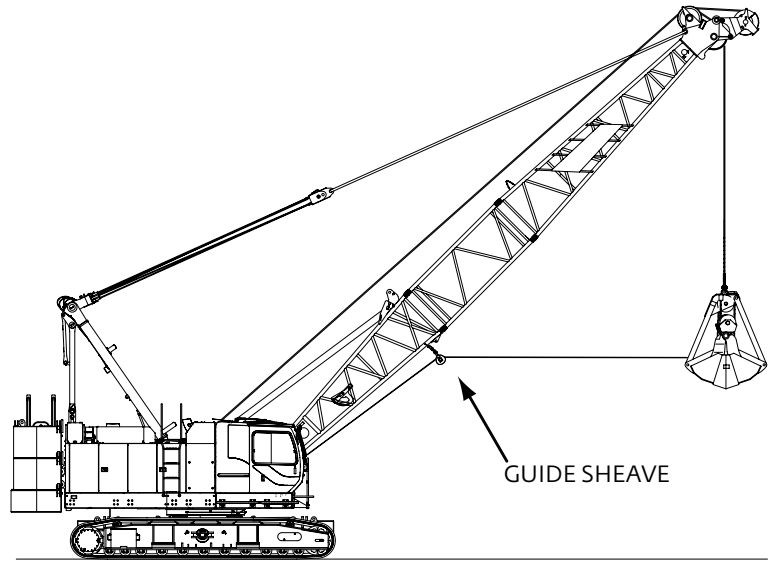

1. Figures represent maximum allowable capacity, and assume level ground and ideal working conditions.
2. Capacities are calculated at 66% of the minimum tipping loads.
3. Capacities are maximum recommended by PCSA Standard #4. Allowances must be made by the user for such unfavorable conditions as a soft or uneven supporting surface, rapid cycle operations, or bucket suction.
4. The combined weight of the bucket and load must not exceed these capacities.
5. Boom length for clamshell operation should not exceed 100 ft.

Clamshell Capacities

21.8 USt counterweight
(three upper counterweights, crawlers extended)
lb x1000

Boom ft	50	60	70	80	90	100
Radius						
26	22.0*					
30	22.0*	22.0*				
34	21.4*	21.4*	21.4*			
42	17.3*	17.3*	17.3*	17.3*	17.3*	
50		14.6*	14.6*	14.6*	14.6*	14.6*
58		12.5*	12.5*	12.5*	12.5*	12.5*
66			11.0*	11.0*	11.0*	11.0*
74				9.8*	9.7*	9.4*
82					8.3*	8.1*
88						7.2*
94						6.6*

Ratings shown by * are determined by the strength of the boom or other structural components.

Manitowoc Crane Care

Crane Care is Manitowoc's comprehensive service and support program. It includes classroom and on-site training, prompt parts availability, expert field service, technical support and documentation.

That's commitment you won't find anywhere else.

That's Crane Care.

Service training

Manitowoc specialists work with you in our training centers and in the field to make sure you know how to get maximum performance, reliability and life from your cranes.

Manitowoc Cranes Technical Training Centers provide valuable multi-level training, which is available for all models and attachments, in the following format:

- **Intro to Canbus and Canbus 1, 2, 3**
- **Intro to EPIC and EPIC 1, 2, 3**
- **Small Crawler 1**
- **Canbus 1 and 2 assembly, operation and maintenance**
- **EPIC 1 and 2 assembly, operation and maintenance**

Refer to www.manitowoc.com for course descriptions.

Parts availability

Genuine Manitowoc replacement parts are accessible through your distributor 24 hours a day, 7 days a week, 365 days a year.

Service interval kits

200 hour kit

1,000 hour kit

2,000 hour kit

Hydraulic test kit

U.S. standard tools kit

Field service

Factory-trained service experts are always ready to help maintain your crane's peak performance.

For a worldwide listing of dealer locations, please consult our website at: www.manitowoc.com

Technical support

Manitowoc's dealer network and factory personnel are available 24 hours a day, 7 days a week, 365 days a year to answer your technical questions and more, with the help of computerized programs that simplify crane selection, lift planning, and ground-bearing calculations.

For a worldwide listing of dealer locations, please consult our website at: www.manitowoc.com

Technical documentation

Manitowoc has the industry's most extensive documentation; available in major languages and formats that include print, videotape, and DVD/CD.

Additional copies available through your Authorized Manitowoc Distributor.

- Crane operator's manual
- Crane parts manual
- Crane capacity manual
- Crane vendor manual
- Crane service manual
- Luffing jib operator's/parts manual
- Capacity chart manual - attachments

Available from your Authorized Manitowoc Cranes Distributor, these videos are available in NTSC, PAL, SECAM, and DVD formats.

- Your Capacity Chart Video
- Respect the Limits Video
- Crane Safety Video
- Boom Inspection/Repair Video

Crane Care Package

Manitowoc has assembled all of the available literature, CD's and videos listed above plus several Manitowoc premiums into one complete Crane Care Package, which is supplied to the owner of each new crane.

Manitowoc Cranes

Regional headquarters

Americas

Manitowoc, Wisconsin, USA

Tel: +1 920 684 6621

Fax: +1 920 683 6277

Shady Grove, Pennsylvania, USA

Tel: +1 717 597 8121

Fax: +1 717 597 4062

Europe, Middle East, Africa

Ecully, France

Tel: +33 (0)4 72 18 20 20

Fax: +33 (0)4 72 18 20 00

China

Shanghai, China

Tel: +86 21 6457 0066

Fax: +86 21 6457 4955

Greater Asia-Pacific

Singapore

Tel: +65 6264 1188

Fax: +65 6862 4040

Regional offices

Americas

Brazil

Alphaville

Mexico

Monterrey

Chile

Santiago

Europe, Middle East,

Africa

France

Baudemont

Cergy

Decines

Germany

Langenfeld

Italy

Lainate

Netherlands

Breda

Poland

Warsaw

Portugal

Baltar

Russia

Moscow

South Africa

Johannesburg

U.A.E.

Dubai

U.K.

Buckingham

China

Beijing

Chengdu

Guangzhou

Xian

Greater Asia-Pacific

Australia

Brisbane

Melbourne

Sydney

India

Chennai

Delhi

Hyderabad

Pune

Korea

Seoul

Philippines

Makati City

Singapore

Factories

Brazil

Passo Fundo

China

TaiAn

Zhangjiagang

France

Charlieu

Moulins

Germany

Wilhelmshaven

India

Pune

Italy

Niella Tanaro

Portugal

Baltar

Fânzeres

Slovakia

Saris

USA

Manitowoc

Port Washington

Shady Grove

This document is non-contractual. Constant improvement and engineering progress make it necessary that we reserve the right to make specification, equipment, and price changes without notice. Illustrations shown may include optional equipment and accessories and may not include all standard equipment.